

APPION[™]

Star Performance

AC/R Product Catalog



Refrigerant Recovery



ION System Analysis



AC/R System Evacuation

When you have the Need for *Speed*.

Table of Contents

Refrigerant Recovery

G5Twin™	2
G1Single™	4
W.S.R Advantage	6
In the Field	7

AC/R System Evacuation

TEZ8™	8
MegaFlow™ Speed Kit	10
TEZOM™ Micron-Dry Oil	11
In the Field	12
MegaFlow™ Basics	14

ION Digital Gauges

Vacuum Gauge	16
Pressure/Temperature Gauges	18
ION HVAC/R App™	20
In the Field	21

Tools and Accessories

MegaFlow™ V.C.T's	22
MegaFlow™ Seals	23

Additional Information

Parts and Product Index	24
Warranty and Support	25



Our Philosophy...

Based in the shadows of the Rocky Mountains in Colorful Colorado, at Appion Inc. our goals aren't just to create great products for technicians. We continuously strive to improve the AC/R industry through innovation, education, and by sharing our knowledge.

We challenge ourselves to go beyond expectations and build on the dynamic nature of the AC/R market, always with the needs of the technician in mind.

Never Stop Learning...

Education is at the forefront of our business. Whether it's leading educational seminars, on-site trainings for contractors and businesses, learning from our customers, or our open-door policy for anyone with a thirst for knowledge, we are committed to helping the industry move forward in a positive way.



Appion is Applied Innovation

The AC/R systems of today demand accurate, rugged, reliable tools to ensure they are efficiently running at their designed potential.

Appion is in the field alongside service technicians to gain a better understanding of their needs so we can drive innovation in our products.

Only through this understanding can superior products be designed and innovated. This is our purpose.

2

G5Twin™

CYLINDER / CONDENSER



Automatic *Liquid and Vapor* Recovery

4x
Faster

Up to 4x Faster Certified Recovery Rates Compared to units in its class



700+ cfm Turbine Fan More Condensing Power and Faster Recovery

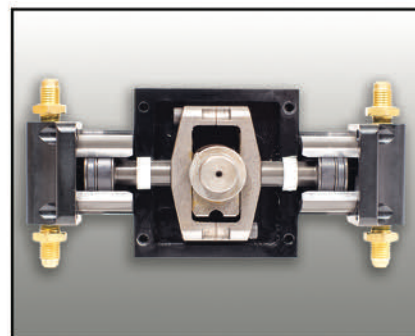

Refrigerant-isolated Crankcase for Maximum Reliability

Why Throttle When You Can Set The Pace

3

The G5Twin is designed to reliably pump liquid without any need for throttling, cutting down on overall recovery time.

The G5Twin is built with a high-efficiency motor and compressor along with massive air-flow. This design allows for maximum pumping performance and cooling efficiency for the **fastest** refrigerant recovery.



Compact Condenser Designed for Full Flow with No Clogging

Recover Liquid First, Then Vapor For Fastest Recovery*

*Use 3/8" hoses, remove all restrictions including valve cores, core depressors, auto-shutoff fittings before recovery



Liquid can be up to 300x more dense than Vapor.

G5Twin Recovery Rates

Refrigerant	Push-Pull	Liquid	Vapor
R134a	15.87 lb/min 7.20 kg/min	10.14 lb/min* 4.60 kg/min*	0.46 lb/min** 0.21 kg/min**
R-22	16.62 lb/min 7.54 kg/min	10.36 lb/min 4.70 kg/min	0.62 lb/min 0.28 kg/min
R-407C	17.61 lb/min 7.99 kg/min	11.93 lb/min 5.41 kg/min	0.5 lb/min 0.25 kg/min
R410A	20.50 lb/min 9.30 kg/min	17.20 lb/min 7.80 kg/min	0.55 lb/min 0.25 kg/min

* Using high speed direct liquid mode; 8.16 lb/min (3/7 kg/min) with standard recovery

** With external cooling accessory; 0/44 lb/min (0.20 kg/min) with standard recovery

Permanently Lubricated Heavy Duty Crankcase Isolated From Refrigerant



Horizontally Opposing Twin Cylinders

NEW
High Speed/High Pressure Turbine Fan Over 700cfm

At only 24 lbs, the industry-leading G5Twin recovery machine is capable of handling the tough demands of industrial and commercial refrigerant recovery - no job is too big for this mighty workhorse

- Patented Opposing Twin Cylinders and Twin Condensers for ultra-fast recovery
- Permanently-lubricated, bearing-lined crankcase is **isolated from refrigerant**, eliminating bearing contamination
- Pumps liquid and vapor with no throttling
- 7-inch, 10-blade turbine fan blasts over **700 cfm of cooling air** over the twin condensers and twin cylinder heads

G5Twin

Product Specifications

Length	11.38 in.	289 mm
Height	10.30 in.	262 mm
Width	9.40 in.	239 mm
Weight	24 lbs.	11 kg
Power	115 VAC, 60 Hz, 10 Amps Int'l: 230 VAC, 50Hz 5 Amps	

4

G1 Single™

SINGLE CYLINDER RECOVERY



Economical **Liquid & Vapor** Recovery



Easy To Use
Ideal For Residential
and Appliance Recovery



700+ cfm Turbine Fan
More Condensing Power
and Faster Recovery

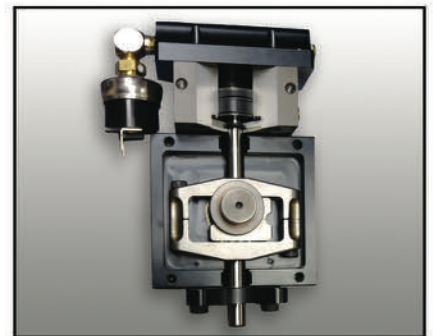

Refrigerant-isolated
Crankcase for
Maximum Reliability

Why Throttle When You Can Set The Pace

5

The G1Single is designed for hands free liquid recovery. With easy to use, no valve operation, the G1Single simplifies the recovery process.

The G1Single is built with a high-efficiency motor and single cylinder compressor along with massive air-flow. This design allows for maximum pumping performance and cooling efficiency for fast and simple refrigerant recovery.

Recover Liquid First, Then Vapor For Fastest Recovery*

*Use 3/8" hoses, remove all restrictions including valve cores, core depressors, auto-shutoff fittings before recovery



Liquid can be up to 300x more dense than Vapor.

G1Single™ Recovery Rates

Refrigerant	Push-Pull	Liquid	Vapor
R-134a	9.44 lb/min 4.28 kg/min	5.20 lb/min* 2.36 kg/min*	0.22 lb/min** 0.10 kg/min**
R-22	10.80 lb/min 4.90kg/min	8.55 lb/min 3.88 kg/min	0.26 lb/min 0.12 kg/min
R-407C	11.33 lb/min 5.14 kg/min	5.84 lb/min 2.65 kg/min	0.31 lb/min 0.14 kg/min
R-410A	12.17 lb/min 5.52 kg/min	4.32 lb/min 1.96 kg/min	0.26 lb/min 0.12 kg/min

* Using high speed direct liquid mode; 8.16 lb/min (3/7 kg/min) with standard recovery

** With external cooling accessory; 0/44 lb/min (0.20 kg/min) with standard recovery

Permanently Lubricated Heavy Duty Crankcase Isolated From Refrigerant

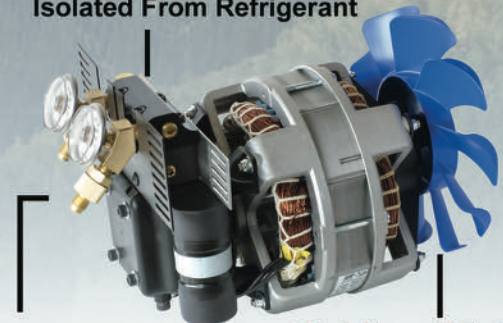

Modular Construction For Easy Repair

High Speed/High Pressure Turbine Fan Over 700cfm

The G1Single is the ultimate machine for use with all residential and appliance recovery jobs.

- Easy to use, ideal for residential and appliance recovery jobs
- Permanently-lubricated, bearing-lined crankcase is **isolated from refrigerant**, eliminating bearing contamination
- No purge cycle required
- 7-inch, 10-blade turbine fan blasts over **700 cfm of cooling air** over the twin condensers and twin cylinder heads

G1Single™ Product Specifications

Length	11.38 in.	289 mm
Height	10.30 in.	262 mm
Width	9.40 in.	239 mm
Weight	22 Lbs.	10 Kgs.
Power	115 VAC, 60 Hz, 10 Amps Int'l: 230 VAC, 50Hz, 5 Amps	

The W.S.R Advantage: Weight, Speed and Reliability

The Lightweight Advantage

- At only 24 lbs. (11 kgs.), the G5Twin is a small and lightweight recovery machine capable of handling the tough demands of industrial/commercial recovery.
- The G1Single delivers comparable recovery rates to larger single-cylinder units at only 22 lbs. without hassle or bulk, ideal for residential and appliance recovery jobs.



We are constantly improving our products. Here is the latest...



New & Improved Fan
delivers more cooling power
& reliability than ever before

The Speed Advantage

- A custom 7-inch, 10-blade turbine fan blasts over 700 cfm of high static pressure cooling air through the machine
- Up to 50°F cooler compressor heads helps refrigerant stay cool & dense, maximizing throughput even in the highest ambient temperature conditions
- Entire unit runs cooler, leading to better operation and a longer life

The Reliability Advantage

- The permanently-lubricated crankcase is isolated from refrigerant, eliminating bearing contamination
- The solid-mounted pistons eliminate wrist pins and bushing wear, ensuring full-speed recovery for the entire life of the machine
- The bearing-lined crankcase evenly spreads the load of each stroke, preventing seized compressors

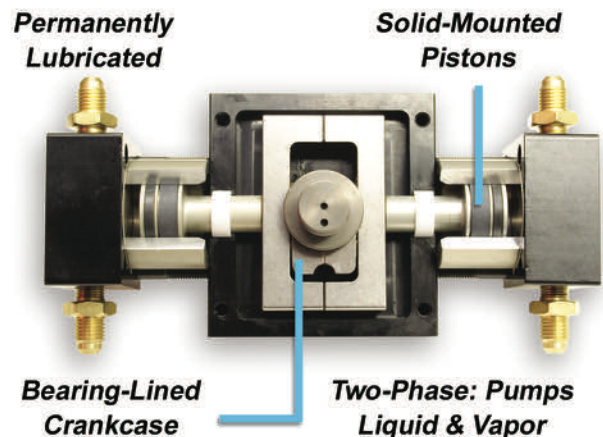

Fast Recovery with the G5Twin

7



Above: Chillers containing 4000 lbs. of R134a being recovered with a G5Twin in the sweltering heat of Saudi Arabia. What once took a week now takes only 18 hours with the speed and reliability of G5Twin.

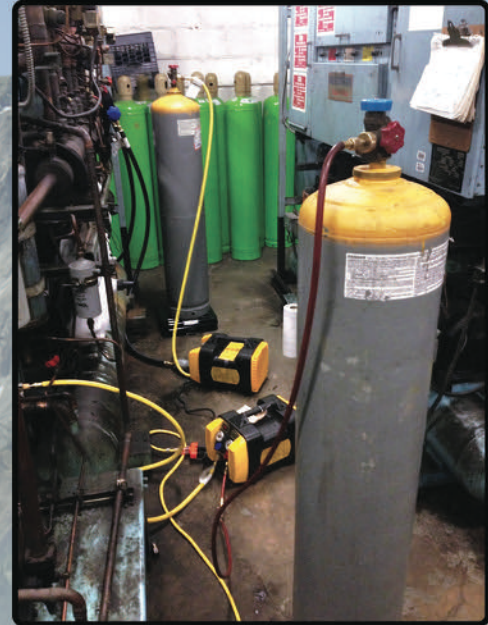

Above: On a R407a system retrofit of a low temperature ice cream case, the G5Twin recovered 600 lbs. of R22 in record time using the push-pull method.



Above: At times running, 8-10 hours a day, 5 days a week, the G5Twin has proven to be extremely fast and reliable. Not a problem, thanks to the G5Twin.

Learn more about
the G5Twin at
www.AppionTools.com/G5Twin



Above: G5Twin used daily in reclamation facility for tank transfer.

TEZ8™

TWO STAGE VACUUM PUMP **8** CFM

Remote Exhaust with a
"Garden Hose" Fitting

Adjustable
Multi-Port Input
for 1/4", 3/8" & 1/2"

TEZOM™ Oil Cartridge:
Clearly Visible Results

Wide, Low
Stance Prevents
Accidental Tipping

Easy-to-Clean
Debris Filter Screen

Clear Debris Tube and
Positive Pressure Relief

Save Hours, Save Days, Save Money

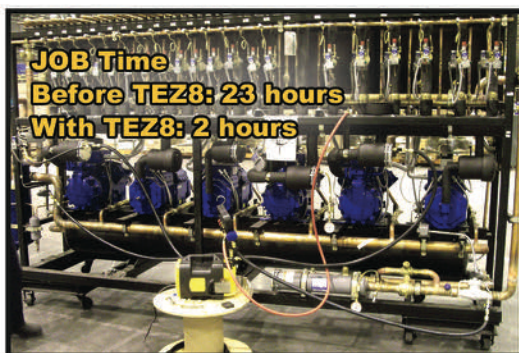

With simultaneous connections, the TEZ8 evacuates racks like these up to 10x faster than typical vacuum pumps



Thanks to massive flow and "on-the-fly" oil changes, the TEZ8 can outperform a 20-cfm belt-driven pump

Did You Know:

You may have to change your Vacuum Pump Oil 10 TIMES in the first 15 minutes of the job... If you want to go FAST



Clean Oil: Easy 5-Second Oil Change™



Use direct connections, large hoses, and no restrictions



Clearly Visible Results Easy to monitor progress

- **Faster Evacuation:** Field-proven to outperform larger, belt-driven pumps by **hours or days**
- **Adjustable Multi-Port Input:** Simultaneous connections to 1/2" and dual 3/8" inputs to allow for maximum flow
- **Two-stage Exhaust System:** Vents moisture without breaking the vacuum, no gas ballast needed
- **"Soft Start" Motor:** Reliable starting in extreme ambient conditions - even as low as -40°F/C

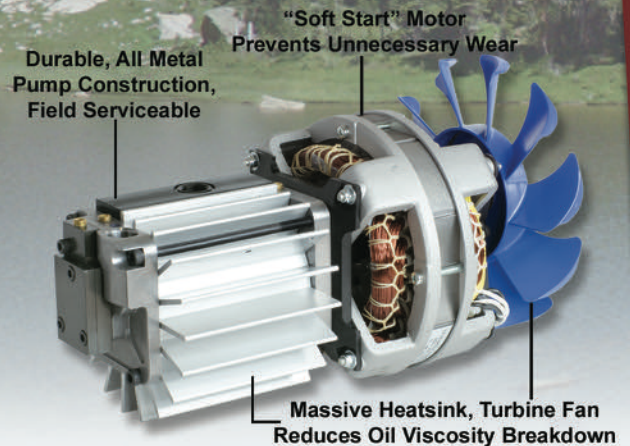

- **High-speed turbine fan & massive aluminum heatsink keeps the pump and oil cooler, reducing oil viscosity breakdown**
- **Advanced "anti-suckback" eliminates check valves and other flow restrictions**
- **Lightweight composite resin case for rugged durability and reduced weight**

TEZ8	Product Specifications	
Length	14.25 in.	362 mm
Height	10.03 in.	262 mm
Width	9.40 in.	239 mm
Weight	28 Lbs.	12.7 Kgs.
Power	115 VAC, 60 Hz, 10 Amps Int'l: 230 VAC, 50Hz 5 Amps Japan: 100 VAC, 60Hz 10 Amps	
Free Air Displacement	8cfm (227 l/m) @ 60 Hz 6.6cfm (189 l/m) @ 50 Hz	
Ultimate Vacuum	< 20 Microns	
Inlet Port Fittings	1/4", 3/8" (x2), 1/2" Flare	

Learn More About The TEZ8 At www.AppionTools.com

MEGA FLOW™

Vacuum Speed Kit



MGAKIT-V

MegaFlow Vacuum Speed Kit Contains

- 2 x 1/2" Hoses (MH120006EAK)
- 2 x 3/8" Hoses (MH380006EAB/EAR)
- 2 x 1/4" Valve Core Tools (MGAVCT)
- 1 Vacuum Manifold (MGAMAN-V)
- 2 x Vacuum Pump Connector Hoses

1/2" Bore Vacuum Manifold

- **Full 1/2" Flow:** Drastically increase speed and reduce evacuation times
- **Vacuum Tree:** 7 ports makes multiple simultaneous connections easy
- **Lightweight & Durable:** Manifold body forged from aircraft-grade aluminum

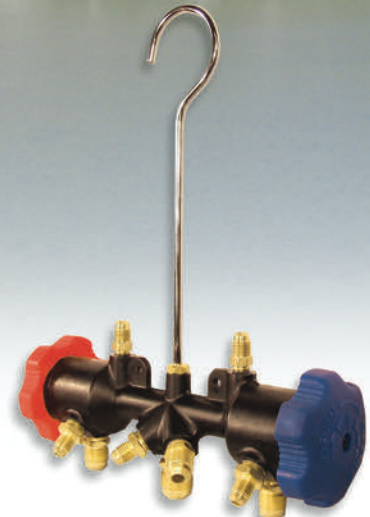

MGAMAN-V

Vacuum-Certified Refrigerant Hoses

- **Larger Interior Diameter:** Greater flow than standard hose
- **Vacuum-Certified:** Won't permeate or collapse in a vacuum



For MegaFlow Hose Part Numbers
Please See Page 24

TEZOMTM

MICRON - DRY

11



TZMGLN

Synthetic Blend Vacuum Pump Oil

- Advanced Synthetic blend keeps ambient moisture out. No cap seal, No problem with TEZOM Micron - Dry
- Synthetic blend improves vacuum pump performance and provides greater protection to internal pump components
- Ultra-low vapor pressure oil (<1 microns) for superior vacuum sealing performance
- For use in any vacuum pump to improve performance
- Faster evacuation of systems that use POE oil (including R410a)

TEZOM Oil Cartridge System for TEZ Vacuum Pumps

- 5-Second Oil ChangeTM – Change the oil “on-the-fly” without breaking the vacuum
- Clean and Dry – Quick and easy oil change removes moisture and dirt, preventing long-term sludge buildup
- Clearly Visible Results – Clear cartridge makes it easy to monitor the condition of the oil



TZM1PK

Learn More About The Micron-Dry Advantage At
www.AppionTools.com

AC/R System Evacuation in 1 day or

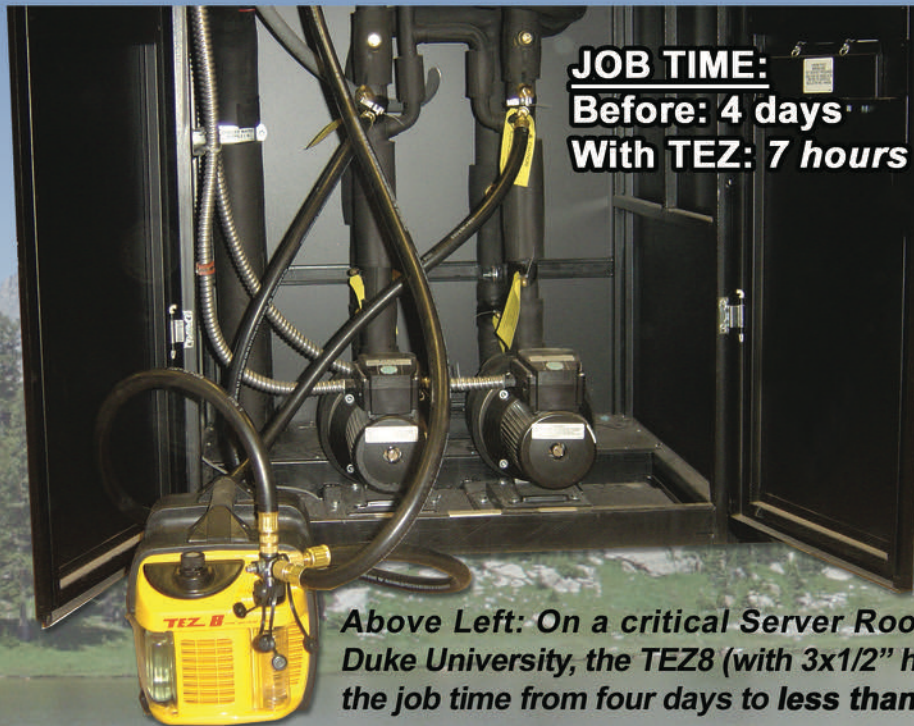

JOB TIME:
 Before: 4 days
 With TEZ: 7 hours

Above Left: On a critical Server Room job at Duke University, the TEZ8 (with 3x1/2" hoses) cut the job time from four days to less than 7 hours.



Above: This 2,000 ton system was evacuated from 2,000 microns atmosphere to 1,000 microns in 1 day instead of days with a belt driven pump.

Below: Thanks to massive flow and "on-the-fly" oil changes, in just 26 hours the TEZ8 evacuated six 1500-ton chillers, one at a time, to 500 microns... outperforming a 20-cfm belt driven pump.



JOB TIME:
 Before: 2 weeks
 With TEZ: 26 hours

5x-10x Faster

The TEZ Speed System uses 3/8" and 1/2" connections (vs. 1" connections) for a time savings ratio of a 10-to-1 (vs. 1-to-1) on residential and industrial job sites.

So for every 5-10 hours you spend evacuating, the TEZ Speed System can do it in 1 hour.

Save Hours, Save Money

AC/R Product Catalog

or less, with the **TEZ Speed System**

13



100 ton chiller was pulled from
1000 microns in only 3.5 hours,
with a belt-driven pump.

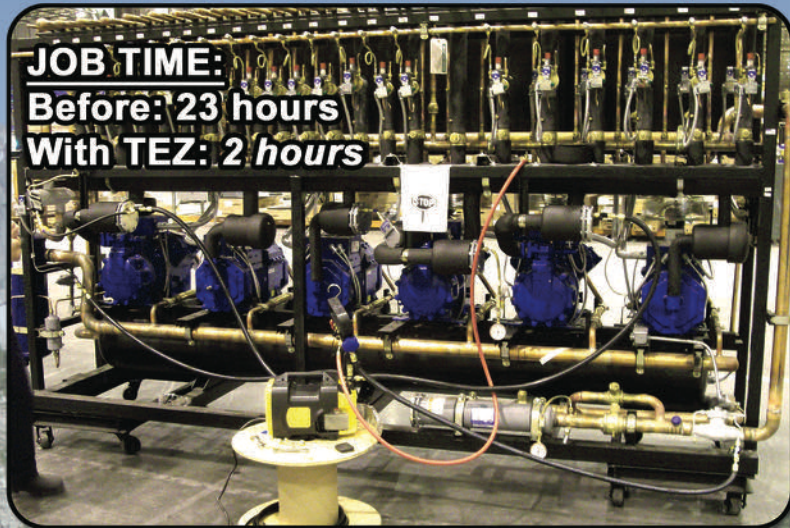

JOB TIME:
Before: 23 hours
With TEZ: 2 hours

Above: With five simultaneous full-flow connections,
the TEZ Speed System evacuates racks like these
up to 10 times faster than typical vacuum pumps.

er Evacuation

tem, using multiple
ctions, can deliver a
of at least 5-to-1 (up
ential, commercial
tes compared to 1/4"

ours you currently
the TEZ Speed
1 hour or less.

Below: Without the TEZ Speed System this job used
to take 2 days. Evacuating this single condenser VRF
unit with 6 evaporators (168,000 BTUHs) and 600 ft of
lineset only took 2 hours.



Days, Save Money.

Appion Inc.

MEGAFLOW™

1/4" Standard & 5/16" Mini-Split BASICS



MGABAS (1/4")

Available in 1/4" Standard
or
5/16" Mini-Split Kits



Faster Evacuation Made Simple

The MegaFlow Basics helps a technician remove restrictive valve cores and perform AC/R system evacuations up to 10x Faster.

Even through 1/4" or 5/16" access ports you can evacuate faster, simply with fewer restrictions and larger diameter hoses.

With these AC/R Evacuation Essentials, your vacuum pump can finally reach its true potential.



MGABRO (5/16")

Evacuating a 10-ton System to 500 microns

6-ft, 1/4" hose through valve core	40 min.
6-ft, 1/4" hose with core removed	19 min.
6-ft, 1/2" hose with core removed	3 min.

NIST-traceable results. All connections made with 1/4" FL Fittings. Results may vary.

- Vacuum-Rated Valve Core Tool removes restrictive cores
- Opens up over 90% of internal diameter of access port
- Large diameter, vacuum-certified, 1/2" evacuation hose
- Allows up to 16x more flow than 1/4" hose
- Vacuum-Rated down to 20 microns

Why remove your valve cores? Valve cores are designed to restrict flow and minimize refrigerant loss. Removing them maximizes flow and can save hours on any job.

Tired of lengthy evacuations?

Evacuating through a valve core & core depressor can reduce the potential flow to as little as 0.2 cfm regardless of vacuum pump size

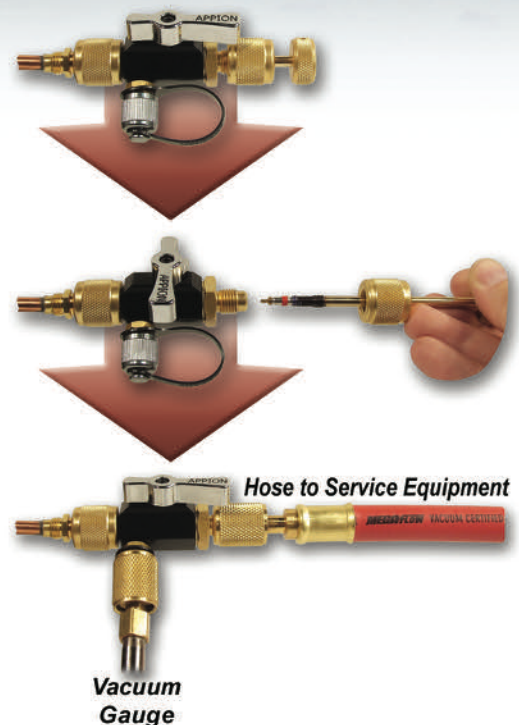

AV760 Full Range Wireless Vacuum Gauge



* Gauge shown at actual atmospheric pressure in Denver, CO (5280 ft).

**Accurate measurement from atmosphere to 1 Micron
NIST-traceable accuracy with 10-point certification**



Remote, Real-Time Measurements

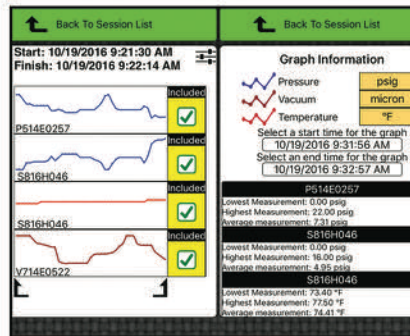

Live Data Logging and Reporting†



Built to Withstand Real-World Conditions

† Allows for documentation of system commissioning service work for compliance with state and local Acceptance Testing.

AV760

Range	760,000 Microns to 1 Micron
Accuracy	±5% or 10 Microns (1 to 5k) ±5% (5k to ATM)
Calibration Points	NIST-traceable 10-point certification
Resolution	1 Micron (1-499), 5 (500-2k) 50 (2k-5k), 250 (5k-15k), 1k (15k-ATM)
Maximum Overpressure	400 psi
Fitting	1/4" Male SAE Flare
Units	Microns, mTorr, kPa, mBar, in/Hg, psia

* Each gauge includes one 1/4" to 1/4" swivel vacuum connector.



Contents Include:

- 1/4 in. MegaSeal Cap
- Spare Filters
- MegaSeal 4 in. 45° Vacuum-Rated Connector
- Batteries

Easy to clean sensor housing

- **Full Range Response:** Unprecedented accurate measurements from atmosphere (760,000 microns) to 1 Micron
- **Oil Protection:** Filter & oil catch to keep sensors clean and maintain accurate measurement
- **Durable:** Rubberized water-resistant housing (IP65 rated)
- **Advanced System Analysis:** Superheat & Subcool Calculations, Reporting, and more with the ION HVAC/R App™

Full Range Vacuum Measurement and Why It Matters

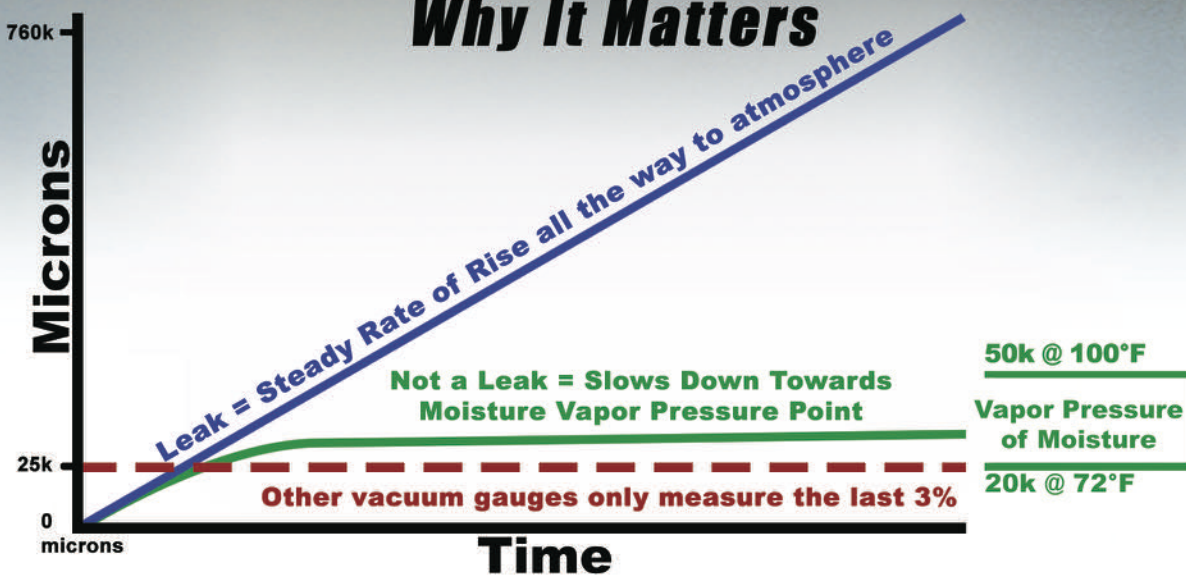

Full Range Vacuum Measurement is crucial to any evacuation. Other vacuum gauges begin measuring at 25,000 microns, only measuring the last 3% of the evacuation process. **Have you ever verified a complete evacuation?** You may think you have, but without verifiable results you can't be sure.

The AV760 gives you the means to track your entire evacuation, the ability to know the difference between a system leak and the presence of contaminants. This complete visibility gives you accurate, verifiable results and confidence that the job is done right.

ION PT Gauges

Pressure / Temperature



**Digital “Stub” Gauges: No Hoses, No Manifold
NIST-traceable accuracy with 5-point certification**



Remote, Real-Time Readings

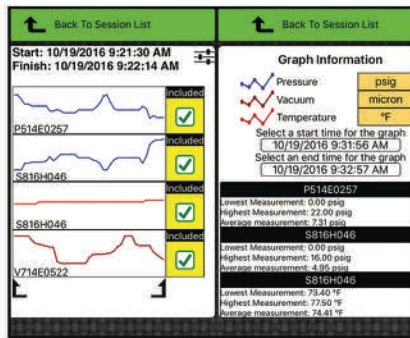

Live Data Logging and Reporting†



Built to Withstand Real-World Conditions

† Allows for documentation of system commissioning service work for compliance with state and local Acceptance Testing.

ION PT Gauges

19

	PT500	PT800
Range	Compound 29 inHg - 500 psi	0 - 800 psi
Accuracy	± 0.5% FS (ASME B40.7 Grade 2A)	± 0.5% FS (ASME B40.7 Grade 2A)
Resolution	0.5 psi	0.5 psi
Units	psi, inHg, kg/cm ² , cm/Hg, bar, kPa, MPa	psi, kg/cm ² , bar, kPa, MPa
Max. (Proof) Overpressure	750 psi	1,000 psi

* Each gauge includes 1x1/8" Male NPT Fitting, 1x1/4" Male and 1x1/4" Female Swivel SAE Flare adapter.

Temperature Sensors

Sensor Type	NTC Thermistor
Working Temperature	-40 - 225°F (-40 - 105°C)
Accuracy	± 0.27°F (0.15°C) 32 - 122°F (0 - 50°C)
Resolution	0.1°F/C
Cable Length	79 in (2m)
Clamp Opening	0.25 - 1.5 in OD

- **View Multiple, Simultaneous Measurements:** "Low Side", "High Side" & Temperature
- **Digital "Stub" Gauges:** Minimize charge loss; perfect for "critical charge" applications
- **Minimized Thermal Mass:** Compact, stainless steel clamp for durability and easy placement
- **Thermally-Isolated Contact Sensor:** Reduced thermal mass for greater accuracy
- **Advanced System Analysis:** Superheat & Subcool Calculations, Reporting, and more with the ION HVAC/R App™

ION PT Gauge Set

(Part #: IONKIT-PT)

Contents include:

- (1) PT500
- (1) PT800
- (2) Thermal Clamps
- (2) Thermal Sensors
- (1) 1/4" Charging-T Fitting
- (1) Angled Connector
- (1) Case



The NEW APPION Solution

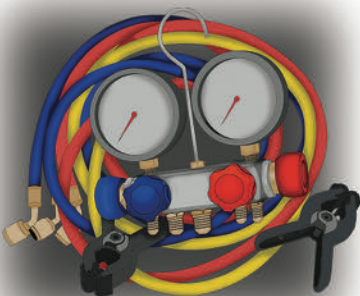

The OLD Problem

0.5% FS*
+
-
0.27° F

*Full Scale (Pressure)

High Accuracy
Temperature
& Pressure
Measurement

Stub Gauge
Connections
= Low Loss



Durable &
IP65 Rated

Sensor Mounts
To Any Size
Pipe



ION HVAC/R App™

Wireless Gauge Features with the ION App™

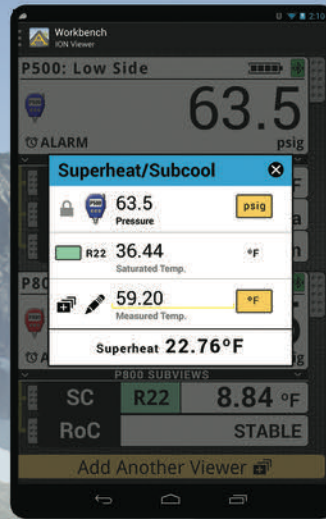

Superheat And Subcool

Monitor system efficiency & determine ideal refrigerant charge using superheat and subcool calculations through manual entries or by connecting to a thermal measurement

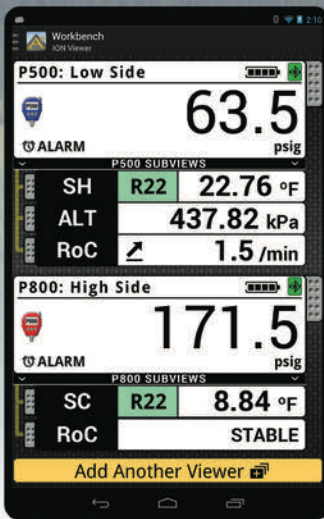

“Digital Manifold” Functionality

Configure the Workbench with multiple “subviews”:

- Calculate Superheat & Subcool measurements.
- Real-time conversion to alternate (ALT) units.
- Access an extensive refrigerant P/T lookup library and more.

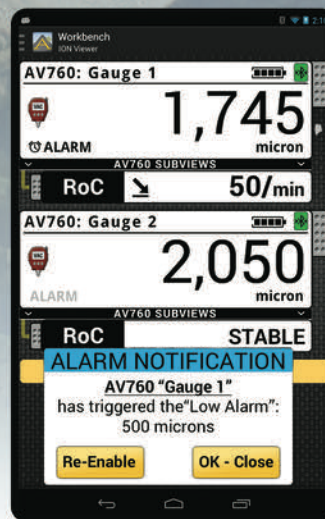

Trending

Monitor evacuation speed with the “Rate of Change” feature to quickly establish if an evacuation has stalled or if the vacuum pump oil needs to be changed.

Custom Alarms

Activate custom alarms and receive notifications when your desired micron level has been reached.



ION HVAC/R App™ Workbench

The Workbench is the primary interface for a technician to interact with the application.

- Determine current readings, Bluetooth® connection status, battery life, and multiple subviews at a glance.
- Connect to multiple devices for advanced “digital manifold” functionality.

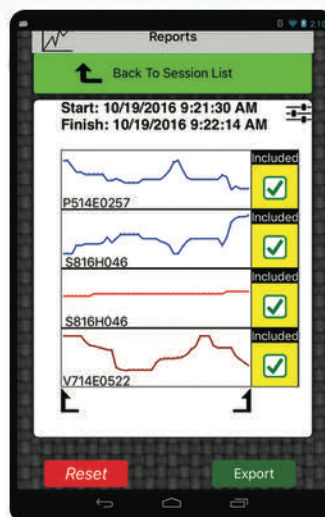

Data Logging & Recording

Record multiple real-time measurements & send data in PDF and Spreadsheet format with the live data logging or reporting function.



ION System Analysis



Wireless Digital Micron Gauge



Wireless Digital PT Gauges



ION HVAC/R App™

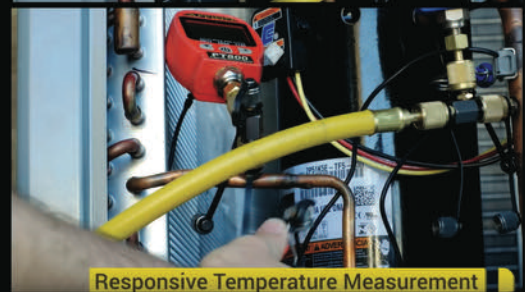

Responsive Temperature Measurement

MEGA FLOW™

Valve Core Tools

MGA VCT



Remove restrictive valve cores for high-speed recovery and evacuation

Available with 1/4" (Black) or 5/16" (Rose) system-side connection

Vacuum-Rated down to 20 microns

Double O-ring seal on ball valve handle for accurate "blank off" vacuum testing

1/4" Side port for service gauges

Designed for high pressure refrigerants including R410a

MGA VCR

Why Remove Your Valve Cores?

Valve cores block up to 90% of the access port. Removing them maximizes flow and will *save hours on any job.*

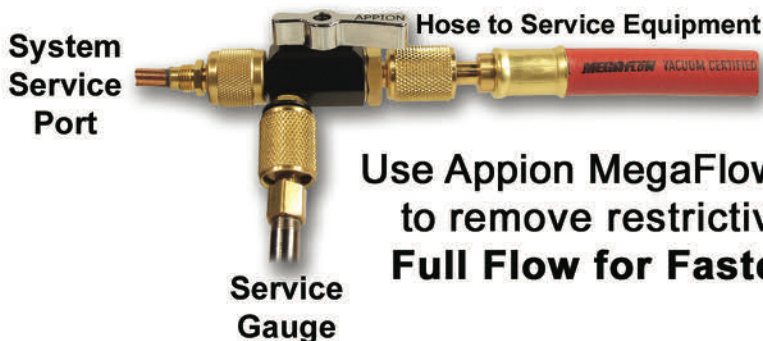
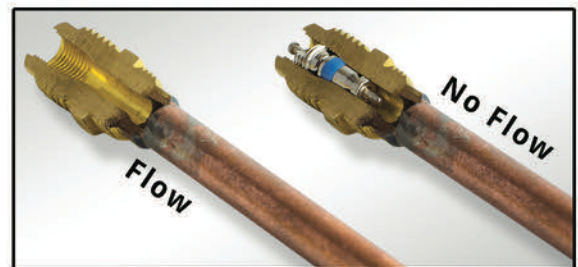

Use Appion MegaFlow™ Valve Core Removal Tools to remove restrictive valve cores and achieve **Full Flow for Faster Recovery & Evacuation**

CTEE14

MegaSeal Charging T-Fittings

Drastically Minimize Charge Loss
Accurately charge AC/R systems
without a manifold or unnecessary hoses

Multifaceted Adapter for Easy Charging
Quickly check system pressure; designed
for pressure and vacuum

Available in 1/4" (Black) and 5/16" (Rose)



CTEE516

MegaSeal Vacuum Connectors

Seamlessly Drawn Construction
eliminates additional leak points

Ultra-Low Volume
For accurate, reliable system vacuum
and pressure measurement



VFL90L

VFL45L

MegaSeal Caps

Machined from Aircraft-Grade Aluminum

Neoprene gasket seals male flare fittings
under pressure and vacuum

For More Information Visit
www.AppionTools.com



Appion Product Index

Pg.	Part #	Description
16	AV760	Full Range Wireless Digital Vacuum Gauge
23	CTEE14	MegaFlow Low-Loss Charging T-Fitting - 1/4" FL
23	CTEE516	MegaFlow Low-Loss Charging T-Fitting - 5/16" FL
6	G1Single	G1Single, Single Cylinder Recovery Unit
4	G5Twin	G5Twin, Twin Cylinder Recovery Unit
19	IONKIT-PT	applION Digital Pressure & Temperature Gauge Kit
14	MGABAS	MegaFlow Basics 1/2" Hose Evacuation Kit & 1/4" VCT
14	MGABRO	MegaFlow Basics 1/2" Hose Evacuation Kit & 5/16" VCT
10	MGAKIT-V	MegaFlow Vacuum Speed Kit
10	MGAMAN-V	MegaFlow Multi-Port Vacuum Manifold
22	MGAVCR	MegaFlow VCT - 5/16" System Connection
22	MGAVCT	MegaFlow VCT - 1/4" System Connection
10	MGH126	6-Inch hose, 1/2" ID, 1/2"FL to 1/2"FL Black
10	MGH126-E	6-Inch hose, 1/2" ID, 1/2"FL to 3/8"FL Black
12	MH120006EAK	1/2" ID, hose, 6 ft, 3/8"FL to 1/2"FL Black
10	MH380006AAY	3/8" ID, hose, 6 ft, 1/4"FL to 1/4"FL Yellow
10	MH380006EAB	3/8" ID, hose, 6 ft, 1/4"FL to 3/8"FL Blue
10	MH380006EAR	3/8" ID, hose, 6 ft, 1/4"FL to 3/8"FL Red
	Custom Hoses	Custom hose lengths & fitting combinations available upon request
18	PT500	Compound 29inHg to 500PSI Digital Pressure & Temperature Gauge
18	PT800	0 to 800PSI Digital Pressure & Temperature Gauge
8	TEZ8	TEZ8, Two Stage Vacuum Pump 8cfm (227 l/min)
11	TZM1PK	TEZOM Oil Cartridge, Pre-charged with Micron-Dry Oil
11	TZMGLN	TEZOM Micron-Dry Oil Gallon, Synthetic Vacuum Pump Oil

G5Twin Repair & Accessories

Part #	Description
AY0036	Fan Gearbox Assembly with Fan Blade
AY0171	Inlet Filter Screens (pack of 4)
AY0221	Case Side Panel with Support Feet
EL5017	Motor Start Relay - 115v
EL5028	Motor Start Capacitor - 115v
EL5030	550PSI Pressure Switch
EL5120	Power Switch w/Breaker
FDT032	032 Inline Filter Dryer
MGH146B	6" hose, 1/4" ID, 1/4"FL to 1/4"FL Blue
KTF032	Inline Filter Dryer Kit
KTF612	Inlet Filter Fitting (1/4" Flare)
KTG515	G5Twin - Piston Seal Kit
KTG520	G5Twin - Compressor Repair Kit
KTG535	G5Twin Front Ball Valve Seal Kit
KTGA00	2-Pack of 0-700Psi Gauges
LB1205	G5Twin Side Label
LB1210	G5Twin 115v Warning Label
PL7000	Case Handle
PL7010	Input Knob - Blue
PL7011	Output Knob - Red
PL7601S	G5Twin Front Panel
PL7602	Case Back Panel
WR900	115v Power cord

G1Single Repair & Accessories

Part #	Description
AY0036	Fan Gearbox Assembly with Fan Blade
AY0171	Inlet Filter Screens (pack of 4)
AY0221	Case Side Panel with Support Feet
EL5017	Motor Start Relay - 115v
EL5028	Motor Start Capacitor - 115v
EL5030	550PSI Pressure Switch
EL5120	Power Switch w/Breaker
FDT032	032 Inline Filter Dryer
MGH146B	6" hose, 1/4" ID, 1/4"FL to 1/4"FL Blue
KTF032	Inline Filter Dryer Kit
KTF612	Inlet Filter Fitting (1/4" Flare)
KTG142	G1Single Piston Seal Kit
KTG166	G1 Single Compressor Rebuild Kit
KTGA00	2-Pack of 0-700Psi Gauges
LB1402	G1Single Front Panel Label
LB1415	G1Single Side Label
LB1417	G1Single Warning Label
PL7000	Case Handle
PL7511S	G1Single Front Panel
PL7602	Case Back Panel
WR9000	115v Power cord

ION Digital Gauge Accessories

Part #	Description
AY0521	1/4" FL Female Swivel Adapter for Digital Gauges
KT2110	Digital Wireless Vacuum Gauge Oil Catch (set of 10)
KTCAP10-14	MegaFlow 1/4" Cap with Straps - 10 pack
MF4014	1/4" FL Male Adapter for Digital Gauges
PL7502	Digital Gauge Carrying Case (9"x11")
PL7506	Digital Gauge Carrying Case (10"x15")
PL7506	Digital Gauge Carrying Case (14"x18")
VFL45B	MegaFlow 45° Connector (1/4" Male to Female)
VFL45L	MegaFlow 4" 45° Connector (2x1/4" Female Flare Swivel)
VFL90L	MegaFlow 4" 90° Connector (2x1/4" Female Flare Swivel)

MegaFlow Repair & Accessories

Part #	Description
AY0533	Valve Core Stem Assembly
KT11AA	MegaFlow Hose Gasket 4x1/4"
KT11EE	MegaFlow Hose Gasket 4x3/8"
KT11GG	MegaFlow Hose Gasket 4x1/2"
KTCAP10-12	MegaFlow 1/2" Cap w/Strap - 10 Pack
KTCAP10-14	MegaFlow 1/4" Cap w/Strap - 10 Pack
KTCAP10-38	MegaFlow 3/8" Cap w/Strap - 10 Pack
KTMM03	Manifold Valve Rebuild Kit
KTMM11	Manifold Seal Replacement Kit
KTMV25	Valve Core Tool (VCT) Rebuild Kit
KTMV40	VCT Body Swivel Fitting O-ring Kit (all Tools)
KTMV56	VCT Body Swivel Fitting O-ring Kit (2nd Gen.)
KTMV58	VCT Stem Assembly O-rings

TEZ8 Repair & Accessories

Part #	Description
AY0036	Fan Gearbox Assembly with Fan Blade
AY0221	Case Side Panel with Support Feet
AY0672	4-Port Input Assembly
AY0677	TEZ8 Case Left Side Panel (TEZOM Side)
EL5095	TEZ8 115v Capacitor (50 microfarad)
EL5120	Power Switch w/Breaker
KTT827	Oil Supply Kit
KTT840	Input Seal & Cap Kit
KTT841	O-rings for Input Assembly & Debris Tube
KTT855	TEZOM Seal Kit
KTT881	Pump Assembly Rebuild Kit
LB1342	TEZ8 Warning Label
LB1344	TEZ8 Side Label
LB1348	TEZ8 Front Panel Label
MF3818	Debris Filter Screen
NB6993	Debris Tube Spring
PL7000	Case Handle
PL7602	Case Back Panel
PL7846S	TEZ8 Front Panel
PL7850	TEZ8 Front Panel Port Cap
PL7894	TEZ8 TEZOM Door
PL7915	Debris Tube Door for TEZ8
PL7922	Debris Catch Tube for TEZ8
WR9000	115v Power Cord

Lifetime Technical Support

Appion offers technical and troubleshooting support for the lifetime of every product. Regardless of your warranty status, you can contact us for assistance.

Our website includes additional technical information that can help you experience the fullest potential of our products, making your job quicker and easier.

Warranty Information

For complete warranty details, visit our website at: www.AppionTools.com/warranty

Appion warranty coverage* includes the following:

Recovery Machines, Vacuum Pumps, and Wireless Digital Gauges:

- Warranty coverage includes over-the-counter exchanges for 90 days after purchase, and no charge repairs for 1 year after purchase.

Components and Accessories:

- Warranty coverage includes over-the-counter exchanges for 90 days after purchase.

Warranty Procedure

All warranty returns and repairs must receive factory authorization and an RGA Number prior to any action. Call or email the factory to request the RGA Number. To help us provide the best service, be sure to have the following information available:

- Serial Number of unit (if applicable)
- Purchase Date of the unit
- A detailed description of the problem, if possible

Contact the Factory

Telephone: (303) 937-1580
 Website: www.AppionTools.com
 Email: Support@AppionTools.com

* Warranty coverage requires prior authorization.

Appion Terms and Conditions Apply. Product and warranty information subject to change at any time without notice. Additional and current details are available at our website: www.AppionTools.com/warranty

Faster Recovery/Evacuation Made Simple

For Useful Service Tips, Free Educational Videos

Visit AppionTools.com



Evacuation: What If I Don't?™



AV760 Vacuum Gauge Accuracy & Repeatability™

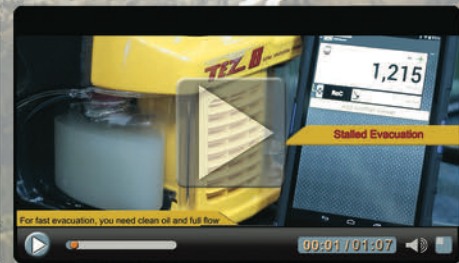

Evacuation: Speed It Up™

...and more!

Appion Inc.
2800 South Tejon Street
Englewood, CO 80110 USA
Tel: (303) 937-1580
Fax: (303) 937-1599

www.AppionTools.com
Sales@AppionTools.com
Support@AppionTools.com

PCACR-EN-A1

COPYRIGHT © 2017 - APPION INC - ALL RIGHTS RESERVED

Apple and the Apple logo are trademarks of Apple Inc., registered in the U.S. and other countries.
App Store is a service mark of Apple Inc. -- Google Play is a trademark of Google Inc.
The Bluetooth® word mark and logos are registered trademarks owned by the Bluetooth SIG, Inc.