



ZEUS PRO

Thermal Imaging Weapon Sight



OPERATION AND MAINTENANCE MANUAL

Important Export Restrictions! Commodities, products, technologies and services of this manual are controlled by the U.S. Department of State Office of Defense Trade Controls, in accordance with International Traffic in Arms (ITAR), Title 22, Code of Federal Regulations Part 120-130 and/or by the Export Administration Regulations (EAR) of U.S. Department of Commerce. At any time when a license or a written approval of the U.S. Government is applicable to it, it is illegal and strictly forbidden to export, intend to export, transfer in any other manner whatsoever, sell any hardware or technical data, provide any associated service to any non-U.S. resident, beyond or within the United States territory, until the valid license or written approval has been issued by the Departments of the U.S. Government having jurisdiction. Additionally U.S. law prohibits the sale, transfer, or export of items to certain restricted parties, destinations, and embargoed countries, as identified on lists maintained by the U.S. Department of State, the U.S. Department of Commerce, and the U.S. Department of Treasury. It is the responsibility of the Customer to be aware of these lists. The sale, transfer, transportation, or shipment outside of the U.S. of any product prohibited or restricted for export without complying with U.S. export control laws and regulations, including proper export licensing, documentation or authorization, is unlawful and may result in civil and/or criminal penalties and/or constitute a federal crime. Diversion contrary to U.S. law is strictly prohibited.



SAFETY SUMMARY

Before operating this product, you must study carefully this Operation and Maintenance Manual.

The Armasight Zeus PRO Thermal Imaging Weapon Sight is a precision electro-optical instrument and requires careful handling. To avoid physical danger to the user and damage to the equipment, follow all WARNINGS, CAUTIONS and NOTES.

Below are definitions of the alerts that will appear throughout this Manual:

WARNING – Identifies a clear danger to the person operating the equipment.

CAUTION – Identifies risk of damage to the equipment.

NOTE – Highlights essential procedures, conditions, statements, or conveys important instructional data to the user.

The information provided in this manual is for familiarization purposes only. The contents may undergo further changes with no commitment by Armasight® to notify customers of any updates.

Armasight® assumes no responsibility for any misprints or other errors that this manual may contain.

©2015 by Armasight. All rights reserved.

**WARNING:**

Always make sure your firearm is unloaded before you place the scope on the firearm. Reconfirm that the chamber is empty if you stop the procedure then resume later. Safe handling rules should be followed at all times.

**WARNING:**

If a scope is mounted too far to the rear, the eyepiece can injure the shooter's brow. Shooting at an uphill angle also increases this hazard because it shortens the distance between the brow and the rear of the scope. For this reason, Armasight scopes are engineered to provide generous eye relief. Therefore, when mounting your scope, we recommend positioning it as far forward in the mounts as possible to take full advantage of this generous eye relief. With hard-recoiling rifles, serious injury or even death can result from eyepiece impact with the shooter during the recoil process when discharging the firearm. Be certain that your installation provides sufficient eye relief for the recoil generated by your rifle before shooting the firearm.

NOTE: Give special attention to this warning when shooting uphill and/or from a prone position. These shooting conditions can dramatically reduce eye relief. PLEASE maintain maximum eye relief when shooting heavy recoiling and/or magnum firearms. THE USER ASSUMES ALL RESPONSIBILITY AND LIABILITY FOR HAVING THE ARMASIGHT RIFLESCOPE PROPERLY MOUNTED TO A FIREARM AND USING THE ARMASIGHT RIFLESCOPE PROPERLY. ALWAYS CHECK THE CONDITION OF YOUR MOUNTING SYSTEM PRIOR TO USING YOUR FIREARM.

**WARNING:**

This product contains natural rubber latex, which may cause allergic reactions! The FDA has reported an increase in the number of deaths that are associated with an apparent sensitivity to natural latex proteins. If you are allergic to latex, it is a good idea to learn which products contain it and strictly avoid exposure to those products.

CAUTION:

- Do not dismantle the equipment.
- Keep the equipment clean. Protect it from moisture, dramatic temperature drops, and electrical shocks.
- DO NOT force the equipment controls past their stopping points.
- DO NOT leave the equipment activated during breaks in operation.
- DO NOT store the equipment with the batteries installed.
- Thoroughly clean and dry each item before placing them into the storage case.

CAUTION:

To prevent thermal damage to the equipment, never point it, either on or off, directly at the sun or any other source of high intensity light that the unprotected human eye cannot tolerate (such as a welding arc). To prevent inadvertent exposure to these types of sources, never leave the equipment with the objective lens cap off.

NOTES:

- Zeus PRO must be zeroed each time it is mounted to a **new** weapon.
- To avoid losing unsaved data, DO NOT remove the batteries or disconnect the external power source while the Zeus PRO is on.
- Inadvertent sun damage is not considered a defect in material or workmanship, and is therefore not covered in the product warranty.

LIST OF CONTENTS

TITLE	PAGE
Safety Summary	2
List of Contents	4
List of Figures	5
List of Tables	6
How to Use This Manual	6
1. INTRODUCTION	7
1.1 General Information	7
1.1.1 Type of Manual	7
1.1.2 Model Number and Equipment Name	7
1.1.3 Purpose of Equipment	8
1.1.4 Reporting Equipment Improvement Recommendations	8
1.2 Warranty Information and Registration	8
1.2.1 Warranty Information	8
1.2.2 Limitation of Liability	9
1.2.3 Product Warranty Registration	9
1.2.4 Obtaining Warranty Service	9
1.3 List of Abbreviations	10
2. DESCRIPTION AND DATA	11
2.1 System Description	11
2.2 Specifications	13
2.3 Standard Components	16
2.4 Optional Equipment	17
2.5 Key Features	18
3. OPERATING INSTRUCTIONS	19
3.1 Installation and Mounting	19
3.1.1 Battery Installation	19
3.1.2 Installing the Zeus PRO on a Picatinny/Weaver Rail	21
3.1.3 Clamping Device Adjustment	22
3.1.4 Fastening an Advanced Wireless Remote Control to a Weapon	22
3.1.5 Installing Additional Equipment	22
3.1.6 Connecting an Additional Equipment	22
3.2 Controls and Display Indications	23
3.2.1 Controls	23
3.2.2 Main Menu	26
3.2.3 Display Indications	31
3.3 Operating Procedures	32
3.3.1 Operating	32
3.3.2 Bore Sighting the Zeus PRO	34
3.3.3 Zeus PRO Shut-Down	36
4. PREVENTIVE MAINTENANCE AND TROUBLESHOOTING	37
4.1 Preventive Maintenance Checks and Services	37
4.1.1 Preventive Maintenance Checks and Services (PMCS)	37

4.2 Operator Troubleshooting	38
4.3 Maintenance	39
4.3.1 General	39
4.3.2 Cleaning Procedures	40
4.3.3 Bore Sighting	40
4.3.4 Battery Removal and Replacement	40
4.4 Return Instructions	41
APPENDIX	42
A Product Warranty Registration Card	42
B List of Spare Parts	43

LIST OF FIGURES

FIGURE	TITLE	PAGE
2-1	Zeus PRO Thermal Imaging Weapon Sights Appearance	11
2-2	System Description	13
2-3	Standard Components	16
2-4	Optional Equipment	17
3-1	CR123 Battery Installation	19
3-2	Removing of the Battery Insert	20
3-3	AA Battery Installation	20
3-4	Mount Assembling	21
3-5	Mount. Underside View	21
3-6	Advanced Wireless Remote Control	22
3-7	Armasight Digital Recorder DT Installation	23
3-8	Optional Video Cable	23
3-9	Controls	24
3-10	Button Control Panel	24
3-11	Main Menu Navigation Buttons	26
3-12	Main Menu	26
3-13	Palette Menu	27
3-14	Reticle Menu	27
3-15	Boresight Menu	28
3-16	Enhancement Menu	28
3-17	Digital Contrast Correction	29
3-18	Sharpness Correction	29
3-19	Smart Scene Optimization	29
3-20	"Sky/Sea" Enhancement	30
3-21	Store Image Menu	30
3-22	Settings Menu	30
3-23	Power Down Menu	31
3-24	Status View	31
3-25	Setting Buttons	33
3-26	Reticle Patterns	33
4-1	Advanced Wireless Remote Control Battery Installation	40
B-1	Zeus PRO Spare Parts List	43

LIST OF TABLES

TABLE	TITLE	PAGE
2-1	System Description	13
2-2	System Data	13
2-3	Optical Data	14
2-4	Electrical Data	15
2-5	Mechanical Data	15
2-6	Environmental Data	15
2-7	Advanced Wireless Remote Control (AWREC) Data	15
2-8	Standard Components	16
2-9	Optional Equipment	17
3-1	Controls and Indicators	24
3-2	Button Controls	25
3-3	Example of Calculating Boresight Corrections	35
4-1	Preventive Maintenance Checks and Services	37
4-2	Operator Troubleshooting	39
B-1	Zeus PRO Spare Parts List	41

HOW TO USE THIS MANUAL

USAGE

You must familiarize yourself with the entire manual before operating the equipment. Read the entire maintenance checklist before performing maintenance. Follow all WARNINGS, CAUTIONS, and NOTES.

MANUAL OVERVIEW

The Manual contains sections on operating and maintaining the Zeus PRO Thermal Imaging Weapon Sights.

Throughout this Manual, the Zeus PRO Thermal Imaging Weapon Sight will be referred to as the Zeus PRO, "the scope," or "the equipment."

The Product Warranty Registration Card is in Appendix A.

A List of Spare Parts is in Appendix B.

INTRODUCTION

1.1 GENERAL INFORMATION

1.1.1 TYPE OF MANUAL

Operation and Maintenance (including a List of Spare Parts).

1.1.2 MODEL NUMBER AND EQUIPMENT NAME

The equipment is available in the following versions that are structurally different in terms of thermal imaging cameras and objective lenses:

Zeus PRO 336 2-8x30 (30Hz) Thermal Imaging Weapon Sight,
FLIR Tau 2 - 336x256 (17 μ m) 30Hz Core, 30mm Lens

Zeus PRO 336 2-8x30 (60Hz) Thermal Imaging Weapon Sight,
FLIR Tau 2 - 336x256 (17 μ m) 60Hz Core, 30mm Lens

Zeus PRO 336 4-16x50 (30Hz) Thermal Imaging Weapon Sight,
FLIR Tau 2 - 336x256 (17 μ m) 30Hz Core, 50mm Lens

Zeus PRO 336 4-16x50 (60Hz) Thermal Imaging Weapon Sight,
FLIR Tau 2 - 336x256 (17 μ m) 30Hz Core, 50mm Lens

Zeus PRO 336 8-32x100 (30Hz) Thermal Imaging Weapon Sight,
FLIR Tau 2 - 336x256 (17 μ m) 30Hz Core, 100mm Lens

Zeus PRO 336 8-32x100 (60Hz) Thermal Imaging Weapon Sight,
FLIR Tau 2 - 336x256 (17 μ m) 30Hz Core, 100mm Lens

Zeus PRO 640 1-8x30 (30Hz) Thermal Imaging Weapon Sight,
FLIR Tau 2 - 640x512 (17 μ m) 30Hz Core, 30mm Lens

Zeus PRO 640 1-8x30 (60Hz) Thermal Imaging Weapon Sight,
FLIR Tau 2 - 640x512 (17 μ m) 60Hz Core, 30mm Lens

Zeus PRO 640 2-16x50 (30Hz) Thermal Imaging Weapon Sight,
FLIR Tau 2 - 640x512 (17 μ m) 30Hz Core, 50mm Lens

Zeus PRO 640 2-16x50 (60Hz) Thermal Imaging Weapon Sight,
FLIR Tau 2 - 640x512 (17 μ m) 60Hz Core, 50mm Lens

Zeus PRO 640 4-32x100 (30Hz) Thermal Imaging Weapon Sight,
FLIR Tau 2 - 640x512 (17 μ m) 30Hz Core, 100mm Lens

Zeus PRO 640 4-32x100 (60Hz) Thermal Imaging Weapon Sight,
FLIR Tau 2 - 640x512 (17 μ m) 60Hz Core, 100mm Lens

1.1.3 PURPOSE OF EQUIPMENT

The Zeus Pro family of Thermal Weapon Sights showcases the best and latest advancements developed by Armasight in the field of uncooled thermal imaging technology for the dismounted soldier, special law enforcement team member, and professional hunter. The Zeus Pro epitomizes Armasight's 20/50 design gold standard, which is defined from product inception as being capable of withstanding 20 meters immersion for 2 hours and engineered for routine use with 0.50 BMG weapon shock and recoil.

The Zeus PRO series is intended for use on a variety of weapons equipped with a Picatinny/Weaver rail. Displaying the thermal differences in the scene, the high-performance thermal imaging system of the Zeus PRO provides round-the-clock, all-weather detection and discrimination of heat-generating objects (such as animals), including those that are hidden. The Zeus PRO series scopes are effective at close and long ranges irrespective of light and weather conditions, i.e., in total darkness, through smoke, haze, fog, and light rain.

The Zeus PRO is available in different versions with optical magnifications ranging from 1x to 8x. Zeus PRO series also provides up to 8x digital zoom for models based on 640x512 cores and up to 4x digital zoom for models based on 336x256 cores.

Armasight has introduced a unique dual battery option for the Zeus Pro Thermal Weapon Sight consisting either of four 3.0VDC 123A batteries all oriented in the same direction to prevent confusion in replacement, or four 1.5VDC AA batteries pre-loaded in a cartridge. The Extended Battery Pack or 6VDC/ 600mA power source can also be used to power the Zeus PRO.

The Zeus PRO can be controlled by a wireless remote control that fastens to the weapon.

The Zeus PRO series scopes are equipped with a standard NTSC/PAL video input/output function that makes it possible to connect to an external video display or monitor, or to record thermal images for field documentation or training purposes. It also allows the transmission of data from one remote display to that of the Zeus PRO.

The Zeus PRO can be used in conjunction with other Armasight equipment such as the Digital Video Recorder DT, MCS Miniature Collimating Sight, and Laser Modular Range Finder that can be mounted onto the Picatinny/Weaver rail of scope or detachable platform ring.

Extremely reliable, the Zeus PRO is the most versatile and sophisticated Armasight product for hunters, SWAT teams, and military personnel.

1.1.4 REPORTING EQUIPMENT IMPROVEMENT RECOMMENDATIONS

User recommendations for improvements to the device are encouraged.

Mail your comments to:

Armasight Inc.
815 Dubuque Avenue,
South San Francisco, CA 94080,
USA.

Or, send an email to info@armasight.com.

1.2 WARRANTY INFORMATION AND REGISTRATION

1.2.1 WARRANTY INFORMATION

This product is guaranteed to be free from manufacturing defects in material and workmanship under normal use for a period of three (3) years from the date of purchase. This warranty does not cover the battery or damage caused by leaking batteries. Nor does it protect against damage due to loss, misuse or mishandling. Uncooled thermal camera sensor is warranted for a period of ten (10) years from the date of purchase.

In the event a defect that is covered by the warranty occurs during the 3 year period stated above, Armasight, at its option, will either repair or replace the product, and such action on the part of Armasight shall be the full extent of Armasight's liability, and the Customer's sole and exclusive remedy. This warranty does not cover a product (a) used in other than its normal and customary manner; (b) subjected to misuse; (c) subjected to alterations, modifications or repairs by the Customer or by any party other

than Armasight without prior written consent of Armasight; (d) special order or “close-out” merchandise or merchandise sold “as-is” by either Armasight or the Armasight dealer; or (e) merchandise that has been discontinued by the manufacturer and either parts or replacement units are not available due to reasons beyond the control of Armasight. Armasight shall not be responsible for any defects or damage that in, Armasight’s opinion, is a result from the mishandling, abuse, misuse, improper storage or improper operation, including use in conjunction with equipment which is electrically or mechanically incompatible with or of inferior quality to the product, as well as failure to maintain the environmental conditions specified by the manufacturer.

This warranty is extended only to the original purchaser. Any breach of this warranty shall be waived unless the customer notifies Armasight at the address noted below within the applicable warranty period.

The customer understands and agrees that except for the foregoing warranty, no other warranties written or oral, statutory, expressed or implied, including any implied warranty of merchantability or fitness for a particular purpose, shall apply to the product. All such implied warranties are hereby and expressly disclaimed.

1.2.2 LIMITATION OF LIABILITY

Armasight will not be liable for any claims, actions, suits, proceedings, costs, expenses, damages or liabilities arising out of the use of this product. Operation and use of the product are the sole responsibility of the Customer. Armasight’s sole undertaking is limited to providing the products and services outlined herein in accordance with the terms and conditions of this Agreement. The provision of products sold and services performed by Armasight to the Customer shall not be interpreted, construed, or regarded, either expressly or implied, as being for the benefit of or creating any obligation toward any third party or legal entity outside Armasight and the Customer. Armasight’s obligations under this Agreement extend solely to the Customer.

Armasight’s liability hereunder for damages, regardless of the form or action, shall not exceed the fees or other charges paid to Armasight by the customer or customer’s dealer. Armasight shall not, in any event, be liable for special, indirect, incidental, or consequential damages, including, but not limited to, lost income, lost revenue, or lost profit, whether such damages were foreseeable or not at the time of purchase, and whether or not such damages arise out of a breach of warranty, a breach of agreement, negligence, strict liability or any other theory of liability.

1.2.3 PRODUCT WARRANTY REGISTRATION

In order to validate the warranty on your product, Armasight must receive a completed Product Warranty Registration Card for each unit, or the Customer can complete a warranty registration on our website at www.armsight.com. Please complete the included form (Appendix A) and immediately mail it to our Service Center:

Armasight Inc.
815 Dubuque Avenue
South San Francisco, CA 94080
USA

1.2.4 OBTAINING WARRANTY SERVICE

To obtain warranty service on your unit, the End-user must notify the Armasight’s service department in order to receive a Return Merchandise Authorization number (RMA#). The customer can do this by sending an email to service@armsight.com.

When returning any product, please take or send the product, postage paid, with a copy of your sales receipt, to our service center, Armasight Inc. at the address noted above. All merchandise must be fully insured with the correct postage; Armasight will not be responsible for improper postage or missing or damaged merchandise during shipment.

When sending merchandise back, please write the RMA# clearly on the outside of the shipping box. Please include a letter that indicates your RMA#, Name, Return Address, reason for service return, Contact information (such as a valid telephone number and/or e-mail address), as well as proof of your purchases that will help us to establish the valid start date of the warranty. Product merchandise returns that do not have an RMA listed may be refused or be subject to a significant delay in processing.

Estimated Warranty service time is 10-20 business days. The End-user/Customer is responsible for postage to Armasight for any warranty service. Armasight will cover return postage/shipping to continental USA End-users/Customers after warranty repair only if product is covered by the aforementioned warranty. Armasight will return the product after warranty service via domestic ground service and/or domestic mail. The postage and shipping fees for any other requested, required or international shipping methods will be the responsibility of the End-user/Customer.

1.3 LIST OF ABBREVIATIONS

µm	micrometer
AWREC	Advanced Wireless Remote Control
C	Celsius (Centigrade)
CCW	counterclockwise
CW	clockwise
F	Fahrenheit
FL	Focal Length
g	gram
H	Height
hr	hour
in	inch
inf.	infinity
kg	kilogram
L	Length
lbs	pounds
m	meter
mA	milliampere
mil	angular mil
min	minute
mm	millimeter
MOA	Minute of Angle
mrad	milliradian
NO.	Number
NTSC	National Television Standards Committee
NUC	Non Uniformity Correction
OEM	Original Equipment Manufacturer
oz	ounce
PAL	Phase Alternating Line
PMCS	Preventive Maintenance Checks and Services
POI	Point of Impact
RMA#	Return Merchandise Authorization number
sec	second
SEQ	sequence
SOA	Second of Angle
SR	Service Representative
UCMNUC/FFC	User Controlled Manual Non Uniformity Correction/Flat-Field Correction
V	Volt
W	Width

DESCRIPTION AND DATA

2.1 SYSTEM DESCRIPTION

The Zeus PRO consists of two primary parts: a thermal imaging aiming device and a mount. The equipment comes as shown in Figure 2-1, with the mount secured to the body of the device. The figure represents three versions of the equipment: with a 30mm focal length objective lens, with a 50mm focal length objective lens, and with a 100mm focal length objective lens.

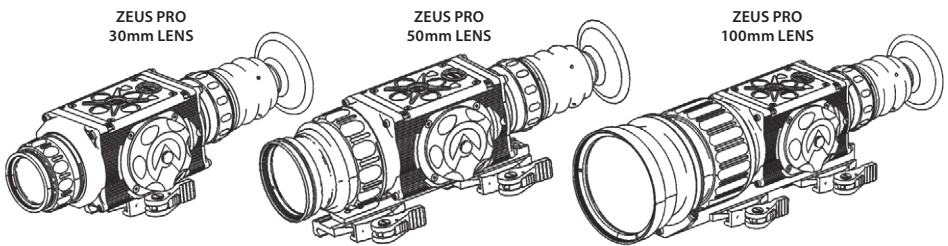

FIGURE 2-1. ZEUS PRO THERMAL IMAGING WEAPON SIGHTS APPEARANCE

The Zeus PRO is a thermosensitive device equipped with an aiming reticle. The Zeus PRO senses the differences in heat emitted by objects in its field of view and converts the received temperature pattern into a viewable image that represents the scene in contrasting black and white or color patterns, depending on the user's selected image palette.

NOTE:

It is important that the Zeus PRO sensor receive sufficient thermal contrast between the target and background area, or between the different parts of a target. The vast temperature contrast between the snow and any heat target (such as an animal) makes it very easy to distinguish the target.

The main optical-electronic components of the Zeus PRO include: an objective germanium thermal lens, an eyepiece, a thermal-imaging camera, a display, a control card, and a button control panel. The reticle is digitally input into the display that is in the image plane.

The Zeus PRO is equipped with manual eyepiece and objective lens focusing, and digital boresight adjustment.

The Zeus Pro Thermal Weapon Sight is characterized by its simple and intuitive controls, functions, and features that are layered among direct button adjustments, direct combination button functions, and electronic menu selections.

To accommodate individual user needs, the Zeus PRO has a variety of digitally controlled options such as:

- Digital Compass
- Digital Inclinometer
- Digital angle cosine indicator in %
- Display Brightness
- Digital Zoom
- Reticle Color Selection
- Reticle Type Selection
- Reticle ON/OFF Selection
- Palette Color Selection
- User Controlled Manual Non Uniformity Correction/Flat-Field Correction (UCMNUC/FFC)
- Boresight Adjustments
- Imaging Enhancements
- Custom Settings

All Zeus PRO series scopes are based on FLIR Tau 2.7.2 or later cameras that allow for improvements in overall image quality in a wide range of dynamic thermal environments., The Zeus PRO has employed special user-adjustable imaging tools that include:

- **Active Contrast Enhancement (ACE)** – a digital “Contrast” correction that allows for a smart scene optimization based on dynamic adjustments where a variety of contrast levels occur depending on relative scene temperature.
- **Second Generation Digital Detail Enhancement (DDE)** – a “Sharpness” correction that is digitally enhances the picture to present clearer imagery, significantly improves edge sharpening and further reduces image noise.
- **Smart Scene Optimization (SSO)** – a fine-tuning computational correction that significantly improves an overall visual acuity for targets that have thermal signatures similar to a surrounding background.
- **Information Based Histogram Equalization (IBHEQ)** – a “Sky/Sea” enhancement – information based environment dependent algorithm that automatically adjusts camera gain and excludes pixels determined to not contain critical information, specifically helpful in scenes with lots of sky or water.
- **User Controlled Manual Non Uniformity Correction/Flat-Field Correction (UCMNUC/FFC).** There is a mechanical shutter between the camera sensor and the lens. This shutter is used to perform a non-uniformity correction (NUC) also known as flat-field correction (FFC). During FFC, the shutter presents a uniform temperature source to each detector element in the array. While imaging the flat-field source, the camera updates the offset correction coefficients, resulting in a more uniform image after the process is complete. All Zeus PRO models allow for user to manually trigger or interrupt scheduled UCMNUC/FFC function.
- **Silent Shutterless NUC™ (SSN)** – In addition to user controlled manual NUC/FFC all Zeus PRO models employ a digital supplemental non-mechanical flat-field correction that allows to extend the periods between mechanical shutter events and to further reduce image noise. SSN is always ON enhancement.

Included in the Zeus Pro are ballistic drop reticles, electronic compass and inclinometer for finer range estimation and target orientation. Information on the current operating state (digital compass and inclinometer data, battery status, active function, the reticle running coordinate in the display, etc.) is continuously displayed, making field operation of the Zeus PRO simple and convenient.

Manufactured for exceptional durability, the Zeus PRO has a lightweight and robust aluminum body. A side Picatinny/Weaver rail allows for the installation of an optional Armasight Digital Video Recorder DT, extended battery pack, laser range-finder or other equipment.

A standard NTSC/PAL video input/output connector enables an external video display (monitor, TV) or video recorder to be connected to the Zeus PRO. The quick-release mount of the Zeus PRO fits any Picatinny, MIL-STD-1913, or Weaver weapon rail. The mount’s lever-cam clamping device ensures quick, easy and reliable mounting and removal.

The Zeus PRO is powered by four 3.0VDC 123A batteries all oriented in the same direction intended to prevent confusion during replacement, or four 1.5VDC AA batteries also pre-loaded in a cartridge in a single orientation

The Zeus PRO with 100mm lens is shown in Figure 2-2. The ITEM NO. column of Table 2-1 indicates the number used to identify items in Figure 2-2.

NOTE:

Here and below, the model Zeus PRO with 100mm Lens is used for the example.

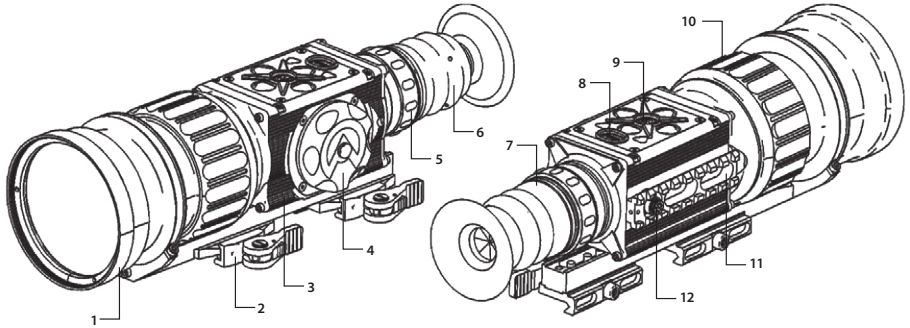

FIGURE 2-2. SYSTEM DESCRIPTION

TABLE 2-1. SYSTEM DESCRIPTION

ITEM	DESCRIPTION	ITEM	DESCRIPTION
1	Objective Lens	8	POWER Button
2	Mount	9	Control Panel
3	Body	10	Objective Focus Ring
4	Battery Cap	11	Side Picatinny/Weaver Rail
5	Eyepiece Focus Ring	12	Connector
6	Eyecup	13	Binder Connector Cap (not shown)
7	Eyepiece	14	Objective Lens Cap (not shown)

2.2 SPECIFICATIONS

TABLE 2-2. SYSTEM DATA

ITEM	ZEUS PRO 336 2-8X30	ZEUS PRO 336 4-16X50	ZEUS PRO 336 8-32X100	ZEUS PRO 640 1-8X30	ZEUS PRO 640 2-16X50	ZEUS PRO 640 4-32X100
Magnification	2x / 2.4x	3.3x / 4x	6.7x / 8x	1.1x / 1.3x	1.8x / 2.1x	3.5x / 4.2x
Objective Lens Type	Germanium					
Focal Plane Array	FLIR Tau 2					
Frame Rate	30 Hz or 60 Hz					
Pixel Array Format	336x256			640x512		
Pixel Size	17 μ m					
Resolution	0.57 mRad (118 SOA)	0.34 mRad (70 SOA)	0.17 mRad (35 SOA)	0.57 mRad (118 SOA)	0.34 mRad (70 SOA)	0.17 mRad (35 SOA)
Display Type	AMOLED SVGA 060					
Pixel Display Format	800x600					
Display Brightness	Discretely Adjustable to 8 Levels					
Turn-on Time, max	3 sec					

TABLE 2-2. CONTINUED

ITEM	ZEUS PRO 336 2-8X30	ZEUS PRO 336 4-16X50	ZEUS PRO 336 8-32X100	ZEUS PRO 640 1-8X30	ZEUS PRO 640 2-16X50	ZEUS PRO 640 4-32X100
Digital Zoom	up to 4x			up to 8x		
Digital Compass	Yes					
Digital Inclinometer	Yes					
Temperature Imaging Modes (Image Palettes)	White Hot, Black Hot, Sepia, Fusion, Rainbow, and Rain					
User-adjustable Image Enhancement Tools	<ul style="list-style-type: none"> • Active Contrast Enhancement (ACE) - "CONTRAST" • Second Generation Digital Detail Enhancement (DDE) - "SHARPNESS" • Smart Scene Optimization (SSO) - "SMART SCENE" • Information Based Histogram Equalization (IBHEQ) - "SKY/SEA" • User Controlled Manual Non Uniformity Correction/ Flat-Field Correction (UCMNUC/FFC) • Silent Shutterless NUC™ (SSN) 					
Reticle Type	6-Pattern Digitally Controlled: "Dot 4 MOA", "Line Dot", "Cross Center Dot", "Cross", "Crosshair", and "No Reticle"					
Reticle Color	Black, White, Red, Cyan					
Windage/Elevation Boresight Adjustment Type	Digitally Controlled					
Windage/Elevation Boresight Increment (NTSC)	1 MOA 0.3 mils 1in/100yd 3cm/100m	0.6 MOA 0.17 mils 0.62in/100yd 1.7cm/100m	0.3 MOA 0.085 mils 0.31in/100yd 0.85cm/100m	2 MOA 0.6 mils 2in/100yd 6cm/100m	1.2 MOA 0.34 mils 1.2in/100yd 3.4cm/100m	0.6 MOA 0.17 mils 0.6in/100yd 1.7cm/100m
Windage/Elevation Boresight Increment (PAL)	0.85 MOA 0.25 mils 0.9in/100yd 2.5cm/100m	0.5 MOA 0.14 mils 0.5in/100yd 1.4cm/100m	0.25 MOA 0.07 mils 0.25in/100yd 0.7cm/100m	1.6 MOA 0.46 mils 1.7in/100yd 4.6cm/100m	1 MOA 0.3 mils 1in/100yd 3cm/100m	0.5 MOA 0.15 mils 0.5in/100yd 1.5cm/100m
Windage Adjustment Range (NTSC/ PAL)	±80MOA / ±68MOA	±48MOA / ±40MOA	±24MOA / ±20MOA	±160MOA / ±128MOA	±96MOA / ±80MOA	±48MOA / ±40MOA
Elevation Adjustment Range (NTSC/ PAL)	±60MOA / ±51MOA	±36MOA / ±30MOA	±18MOA / ±15MOA	±120MOA / ±96MOA	±72MOA / ±60MOA	±36MOA / ±30MOA
Analog Video Input/ Output Format	PAL (768x574 pixels)*/ NTSC (640x480 pixels)					

*Default setting (may be altered at the customer's request).

TABLE 2-3. OPTICAL DATA

ITEM	ZEUS PRO 336 2-8X30	ZEUS PRO 336 4-16X50	ZEUS PRO 336 8-32X100	ZEUS PRO 640 1-8X30	ZEUS PRO 640 2-16X50	ZEUS PRO 640 4-32X100
Field of View (X/Y)	10.9° x 8.3°	6,5° x 5°	3,3° x 2,5°	20,8° x 16,6°	12,5° x 10°	6,2° x 5°
Objective Focal Length	30mm	50mm	100mm	30mm	50mm	100mm
Objective F-number	1:1.2	1:1.4	1:1.4	1:1.2	1:1.4	1:1.4
Eyepiece Focal Length	25 mm					
Exit Pupil Diameter	10 mm					
Eye Relief	45 mm					
Focus Method	Manual					
Focusing Range	3m to inf.	5m to inf.	10m to inf.	3m to inf.	5m to inf.	10m to inf.
Diopter Adjustment	Manual					
Diopter Adjustment	±5 diopter					

TABLE 2-4. ELECTRICAL DATA

ITEM	DATA
Battery	4 each 123A 3.0VDC or 4 each AA 1.5VDC
Battery Life at 20 °C (68 °F)	up to 7 hrs
Extended Battery Pack	Two 18650 rechargeable batteries (3.7V) or four CR123 type rechargeable batteries with voltage 3.7V max or four standard CR123A 3V Lithium batteries
External Power Supply	6 VDC/ 600mA

TABLE 2-5. MECHANICAL DATA

ITEM	ZEUS PRO 336 2-8X30	ZEUS PRO 336 4-16X50	ZEUS PRO 336 8-32X100
	ZEUS PRO 640 1-8X30	ZEUS PRO 640 2-16X50	ZEUS PRO 640 4-32X100
Weapon Mount Type	Picatinny MIL-STD-1913 and Weaver Rails		
Overall Dimensions	170x76x76 mm (6.7x3.0x3.0 in)	197x76x76 mm (7.5x3.0x3.0 in)	265x90x100 mm (10.4x3.5x3.9 in)
Height of the Scope Axis above Rail	42 mm (1.65 in)		
Weight (w/o Batteries)	0.68 kg (1.5 lbs)	0.95 kg (2.0 lbs)	1.3 kg (2.9 lbs)

TABLE 2-6. ENVIRONMENTAL DATA

ITEM	DATA
Operating Temperature	-51 to +57°C (-59 to +134°F)
Storage Temperature	-57 to +85°C (-70 to +185°F)
Recoil Resistance	0.50 BMG weapon shock and recoil
Environmental Rating	Waterproof, 20 meters immersion for 2 hours

TABLE 2-7. ADVANCED WIRELESS REMOTE CONTROL (AWREC) DATA

ITEM	DATA
Type	Wireless Remote Control
Working Range	up to 0.5m
Battery	Single CR2032 Lithium battery (3V)
Battery Life at 20 °C (68 °F)	Approx. 10,000 clicks
Overall Dimensions	48x39x18 mm (1.9"x1.5"x0.7")
Weight (with Battery)	25 g (0.9 oz)
Operating Temperature	-30 to +50°C (-22 to 122°F)
Storage Temperature	-50 to +70°C (-58 to 158°F)
Environmental Rating	Water and Fog Resistant

2.3 STANDARD COMPONENTS

The Zeus PRO standard components are shown in Figure 2-3 and listed in Table 2-8. The ITEM NO. column indicates the number used to identify items in Figure 2-3.

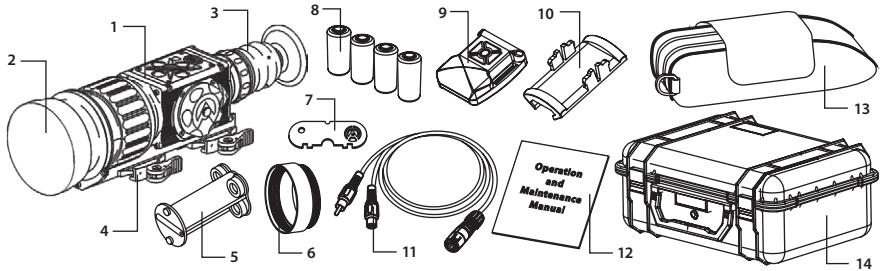

FIGURE 2-3. STANDARD COMPONENTS

TABLE 2-8. STANDARD COMPONENTS

ITEM NO.	DESCRIPTION	QUANTITY
1	Armasight Zeus PRO Thermal Imaging Weapon Sight A thermal imaging aiming device. Comes fully assembled with a quick-release Picatinny/Weaver mount.	1
2	Objective Lens Cap Securely protects the objective lens from dirt and mechanical damage and provides thermal protection of the Zeus PRO. Comes attached to the objective lens.	1
3	Eyecup A specially designed latex eyecup that reduces the amount of light that escapes from the eyepiece and prevents illumination of the user's face, minimizing the risk of detection. Prevents ambient light from entering the equipment. Allows for correct and comfortable positioning. Comes attached to the eyepiece.	1
4	Mount A quick-release mount used to install the Zeus PRO on a Picatinny/Weaver rail. Comes attached to the scope.	1
5	Battery Cartridge Intended for the installation of four AA batteries in the battery compartment.	1
6	Battery Box Extender Ring Extends the battery box for the installation of battery cartridge with AA batteries.	1
7	Armasight Key A special key used to remove the battery cap insert.	1
8	CR123A Lithium Battery Two CR123A batteries are used to power the Zeus PRO.	4
9	Advanced Wireless Remote Control (AWREC) Duplicates the functions of the control panel buttons. Comes with CR2032 (3V) battery installed.	1
10	Picatinny Adapter for Advanced Wireless Remote Control Allows the advanced wireless remote control to be installed on a weapon's Picatinny/Weaver rail.	1
11	Video Cable A cable used to connect the analog video input/output of the Zeus PRO to external display devices (monitor, TV) or power sources.	1

TABLE 2-8. CONTINUED

ITEM NO.	DESCRIPTION	QUANTITY
12	Operation and Maintenance Manual Provides safety information, equipment description, mounting procedures, operating instructions, and preventive maintenance checks and services.	1
13	Carrying Case A textile bag used for the transportation and storage of the Zeus PRO and its accessories.	1
14	Hard Shipping/Storage Case A protective case used for the shipping/storage of the Zeus PRO and its accessories.	1

2.4 OPTIONAL EQUIPMENT

Optional items are shown in Figure 2-4 and listed in Table 2-9.

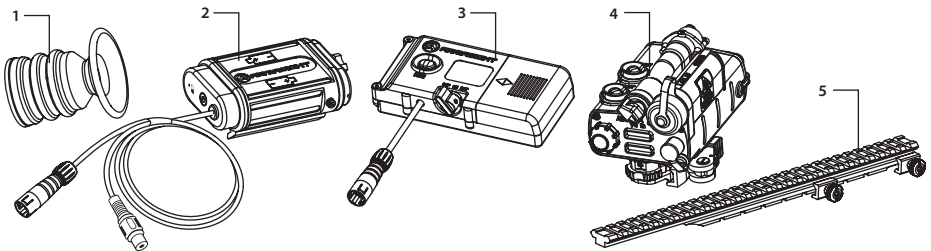

FIGURE 2-4. OPTIONAL EQUIPMENT

The ITEM NO. column indicates the number used to identify items in Figure 2-4.

The PART NO. column indicates the primary number used by the manufacturer, to identify an item.

TABLE 2-9. OPTIONAL EQUIPMENT

ITEM NO.	DESCRIPTION	PART NO.
1	Shutter Eyeguard Prevents light from being emitted by the Zeus PRO eyepiece.	ANEC000010
2	Digital Video Recorder DT A compact digital system used for video recording, storage and playback. Can also serve as an external power source. Equipped with a remote control.	ATAM000004
3	Extended Battery Pack The power source for extended operational time. Takes four CR123A Lithium batteries (3V) or CR123 type rechargeable batteries (3.2V or 3.7V) or two 18650 type rechargeable batteries (3.7V).	ATAM000008
4	AMRF2200 Advance Modular Range Finder Module of a rangefinder is designed to determine the exact distance between the observer and the target. The measurement results are shown on the displays of module and in the field of view of the connected digital device.	IALA00AMRF22001
5	Extended Rail Adapter #85 Dovetail Weaver Picatinny Rail Adapter Extends 7.5" to 11.5" Tactical Scope Mount.	ANAM000045

2.5 KEY FEATURES

- Multiple versions with optical magnifications ranging from 1x to 8x
- 24/7 Operation in presence of environmental obscurants (smoke, dust, haze, fog)
- Superior engineering and design from inception to Armasight's 20/50 standard
- Rugged MIL-STD-810 compliant performance
- Operates on 123A or AA batteries
- Reliable quick-release locking weapon mount
- Objective Germanium Lens Options
- TAU-2 17 μ m Pitch Thermal Sensor
- SVGA 800x600 OLED Display
- Long eye-relief eyepiece lens
- Digital Compass
- Digital Inclinator
- Digital Angle Cosine Indicator
- Battery Status Indicator
- Multiple User Selectable Ballistic and Quick Acquisition Reticules
- Selectable Reticule Color
- Selectable Palettes: White Hot/ Black Hot/ Sepia/ OEM Custom/ Other Color Variants
- Imaging Filter Algorithms:
 - Active Contrast Enhancement™ (ACE)
 - Smart Scene Optimization™ (SSO)
 - Information Based Histogram Equalization™ (IBHEQ)
 - Second Generation Digital Detail Enhancement™ (DDE)
 - Silent Shutterless Non-uniformity Correction™ (SSN)
- Wireless 5-button Remote
- Tracking Digital e-Zoom: 2x / 4x / 8x (640x512 only)
- Still Picture and Video Recording Capability (Mounted DVR Option)
- Analog video input and output (NTSC/PAL)
- Power input capability
- Fits any Picatinny, MIL-STD-1913, and Weaver rail with an adjustable quick-release mount
- Serviceability under severe conditions
- Filled with dry nitrogen to prevent internal fogging
- Waterproof
- Limited 3-year warranty
- 10-year warranty on FLIR detector
- Made In The USA

OPERATING INSTRUCTIONS

3.1 INSTALLATION AND MOUNTING

3.1.1 BATTERY INSTALLATION

CAUTION:

Verify that the equipment is off before installing batteries.

The Zeus Pro is capable of operating on either four (4) CR123A 3.0VDC format lithium batteries OR four (4) AA 1.5VDC format batteries. Using the four (4) CR123A 3.0VDC batteries, the operator can anticipate approximately 6 ½ hours of continuous operation contingent upon the quality and freshness of the batteries installed. Using the four (4) AA 1.5VDC batteries, the operator can anticipate approximately 3 hours of continuous operation contingent upon the quality and freshness of the batteries installed.

Please **note** that regardless of installing CR123 or AA format batteries, the battery polarity orientation is ALWAYS the same for all of the batteries – positive terminal outboard (+ terminal toward the battery cap).

INSTALLATION OF CR123A 3.0VDC BATTERIES:

Install four (4) CR123A batteries as follows (refer to Figure 3-1):

1. Unscrew the battery cap (A).
2. Insert the batteries (B) directly into the battery case with ALL positive terminals facing upward (or in the direction of the battery cap)
3. Replace the battery cap.

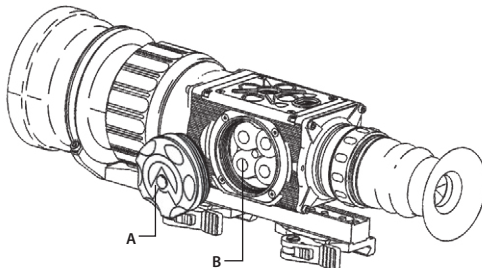

FIGURE 3-1. CR123 BATTERIES INSTALLATION

NOTE:

In a situation where fewer than four (4) CR123A batteries may be available, the Zeus Pro can operated for a very limited time on as few as one (1) CR123A battery installed in any of the battery slots.

INSTALLATION OF AA 1.5VDC BATTERIES:

Install four (4) AA batteries as follows (refer to Figure 3-3):

In order to use four (4) AA batteries in the Zeus Pro, it will be necessary to make a few minor adjustments and to use an AA cartridge device to hold the batteries in place. All of the necessary adapters, tools and equipment are included as standard kit items to perform this function.

1. Unscrew the battery cap.
2. Using the ARMASIGHT key (A, Figure 3-2), remove the battery cap insert (B, Figure 3-2) from the battery cap (C, Figure 3-2).

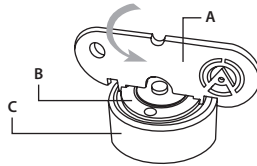

FIGURE 3-2. REMOVING OF THE BATTERY INSERT

3. Install battery box extender ring (A, Figure 3-3):
4. Insert four (4) AA batteries (B) into the battery cartridge (C) with all of the batteries oriented in the same direction with the negative (-) terminal against the cartridge springs and the positive terminal (+) toward the non-spring end.
5. Insert battery cartridge into the battery box.

NOTE:

The cartridge will only fit in one orientation.

6. Replace the battery cap (D) by threading it onto the battery case extender.

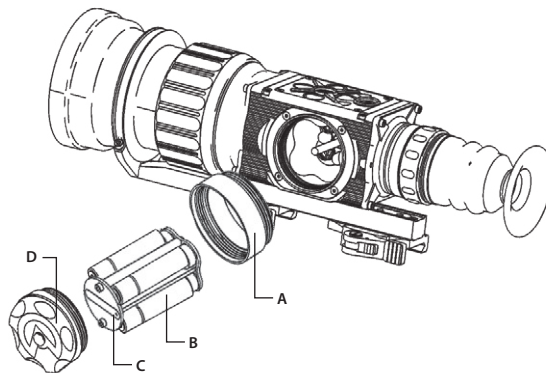

FIGURE 3-3. AA BATTERIES INSTALLATION

NOTE:

In a situation where fewer than four (4) AA batteries may be available, the Zeus Pro can operated for a very limited time on as few as three (3) AA batteries installed in any of the battery cartridge slots.

! WARNING:

Pay close and careful attention to the AA battery orientation when installing into the battery cartridge. Failure to do so will result in batteries overheating in the cartridge and possible damage to the cartridge.

3.1.2 INSTALLING THE ZEUS PRO ON A PICATINNY/WEAVER RAIL

! WARNING:

Always make sure your firearm is unloaded before you place the scope on the firearm. Reconfirm that the chamber is empty if you stop the procedure then resume later. Safe firearms handling rules should be followed at all times.

The Zeus PRO comes fully-assembled with a two Picatinny/Weaver mount (Figure 3-4). The mount (A) is attached to the scope seating rail (B) with two flathead socket cap screws (C).

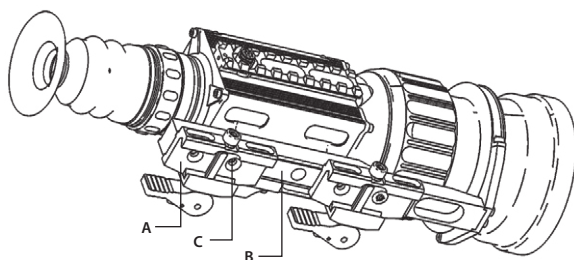

FIGURE 3-4. MOUNT ASSEMBLING

To install the Zeus PRO on a Picatinny/Weaver rail, perform the following:

1. Unlock the clamping device (A, see Figure 3-5) of the scope mount by pushing down on the lever holders (B) and unlocking the levers (C).
2. Install the scope on the Picatinny/Weaver rail so that the stop (D) slides into the transverse slots on the rail.
3. Affix the scope to the rail by locking the levers (C).

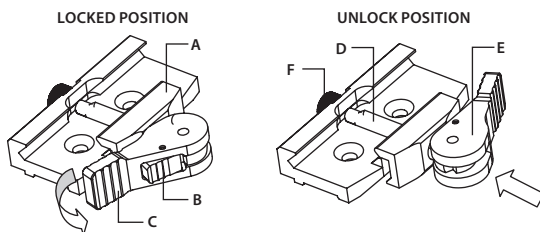

FIGURE 3-5. MOUNT, UNDERSIDE VIEW

4. Verify that the clamping device is firmly holding the Zeus PRO. If necessary, adjust the clamping device's lever-cam locks as detailed in Part 3.1.3 (Clamping Device Adjustment).

3.1.3 CLAMPING DEVICE ADJUSTMENT

To adjust the mount's clamping device, do the following:

1. Remove the Zeus PRO from the weapon.
2. With the clamping device unlocked (as shown in Figure 3-5), push the cam (E) towards the arrow, which will cause the nut (D) to slide out of its hole.

3. To tighten/ loosen the clamping device, push down on the cam (E) and turn the nut (F) CW/ CCW respectively, in one-two increments (see note below). Much like when the cam (E) is released, backward-moving springs will cause the nut (F) to slide back into its hole.

NOTE:

The eight-sided nuts of the mount lever-cam locks will only fit into their holes if turned in one of the discrete positions, using increments equal to $360^{\circ}/8$.

4. Verify that the adjusted lever-cam lock securely holds the weapon mounting rail.
5. Repeat the procedure to adjust the clamping device's second lever-cam lock.

NOTE:

The quick release rail grabbers can be removed and repositioned in other discrete locations to allow the operator to move the Zeus Pro forward or aft for improved ergonomics. Simply remove the two allen-head screws from each mount and, after applying removable Loctite or equivalent threadlock, fasten them down in the desired position.

3.1.4 FASTENING AN ADVANCED WIRELESS REMOTE CONTROL TO A WEAPON

Using the supplied Velcro tape (A, Figure 3-6), fasten the remote control (B) to your weapon in an easily accessible place (e.g., on the front of the rifle stock).

If your rifle has a Picatinny or Weaver rail on the front end, you can use the Picatinny adaptor for the Advanced Wireless Remote (C). Install the adaptor onto the rail (D). Insert the remote control unit into the adaptor.

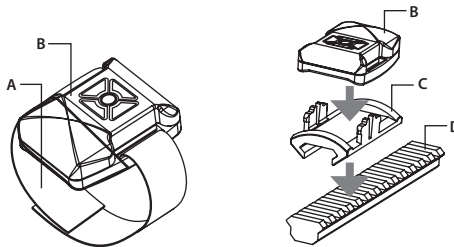

FIGURE 3-6. ADVANCED WIRELESS REMOTE CONTROL

3.1.5 INSTALLING ADDITIONAL EQUIPMENT

Use the side Picatinny/Weaver rail to install any additional equipment, such as the Armasight DT Digital Video Recorder, a rangefinder, or the Extended Battery Pack.

3.1.6 CONNECTING AN ADDITIONAL EQUIPMENT

CAUTION:

Turn off the Zeus PRO before you begin connecting/disconnecting any external equipment and before removing the batteries.

Remove the connector protective cap.

Connect a cable of Armasight DT digital video recorder (Figure 3-7) or the Extended Battery Pack to the Zeus PRO connector.

Use the plug A (Figure 3-8) of a video cable to connect an external video recorder/monitor/TV to the Zeus PRO. Connect the plug C of a video cable to the Zeus PRO connector.

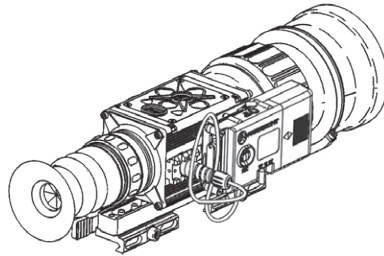

FIGURE 3-7. ARMASIGHT DIGITAL RECORDER DT INSTALLATION

Use the plug B of a video cable to connect an external power source (6VDC/ 600mA) to the Zeus PRO. Connect the plug C of a video cable to the Zeus PRO connector.

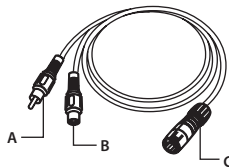

FIGURE 3-8. OPTIONAL VIDEO CABLE

NOTE:

The external power supply must have a standard OD double-pole socket with a positive center contact.

CAUTION:

After removing the cable, replace the protective cap over the connector.

3.2 CONTROLS AND DISPLAY INDICATIONS

3.2.1 CONTROLS

CAUTION:

DO NOT force the equipment controls past their stopping points.

The Zeus PRO controls are shown in Figures 3-9 and 3-10 and are defined in Tables 3-1 and 3-2. The ITEM NO. columns of the tables indicate the numbers used to identify items in the figures.

NOTE:

Various display symbols indicating the current operating state of the Zeus PRO can be displayed permanently, may appear momentarily, or can be set to appear only when a certain function is activated.

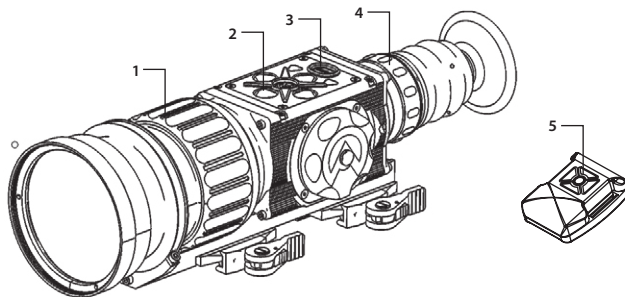

FIGURE 3-9. CONTROLS

TABLE 3-1. CONTROLS AND INDICATORS

ITEM NO.	CONTROL/INDICATOR	FUNCTION
1	Objective Focus Ring	Focuses the objective lens. Adjusts for sharpest view of the scene. The total focus range is covered within 3/4 turn of the focus ring. Focus range is dependent on system magnification.
2	Control Panel Buttons	Configures operational settings. See Table 3-2 for button functions.
3	POWER Button	Turns ON Zeus Pro when pressed momentarily or turns OFF the Zeus Pro when depressed for more than 3 seconds continuously. When the Zeus Pro is operating a single momentary press will take a still image.
4	Eyepiece Focus Ring	Adjusts the eyepiece diopter. The total diopter adjustment range is covered within 2 turns of the ring. The diopter range is -5 to +5 diopters.
5	Remote Control Buttons	A five-button wireless remote switch is included to operate and modify the settings on the Zeus Pro to optimize the imagery for the viewed scene without having to remove your hands from the weapon. Duplicates the functions of the control panel buttons.
—	Battery Status Indicator (a battery icon in the top right hand part of the display)	The color fill (green/yellow/red) bar in the battery icon indicates the current power level of the internal battery, or remaining battery life. The totally shaded battery icon indicates the fully charged battery. The flashing transparent battery icon indicates impending battery failure due to being drained of power.

The Zeus PRO button control panel is shown in Figures 3-10.

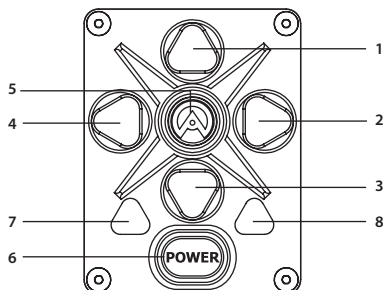

FIGURE 3-10. BUTTON CONTROL PANEL

Table 3-2 contains the button functions and their brief descriptions. The ITEM NO. column of the table indicates the number used to identify buttons in Figure 3-10.

NOTE:

Each button is responsible for some functions selected by a short momentary push or by depressing the button for 3 seconds, or using the button in combination with other one, as described in Table 3-2.

If the button pushing time exceeds 3 sec, this will be taken as holding down the button.

TABLE 3-2. BUTTON CONTROLS

ITEM NO.	FUNCTION	DESCRIPTION
	DISPLAY BRIGHTNESS CONTROL	Press button (1) momentarily to increase the screen brightness or press button (3) momentarily to decrease the screen brightness.
	IMAGE PALETTE CONTROL	To scroll up through the available palettes, press and hold button (1) or (3) to scroll down or up respectively. There are 6 palettes available: White Hot, Black Hot, Sepia, Fusion, Rainbow, and Rain.
1, 3	USER CONTROLLED MANUAL NON UNIFORMITY CORRECTION/ FLAT-FIELD CORRECTION (UCMNUC/FFC)	Simultaneously holding down buttons (1) and (3) induces manual User Controlled Manual Non Uniformity Correction/Flat-Field Correction (UCMNUC/FFC).
	UP, DOWN	Use the UP (1) and DOWN (3) buttons to navigate through the items when in the menu.
2	DIGITAL ZOOM CONTROL	To change the zoom progressively, push button (2).
	RETICLE ON/ OFF	Pushing and holding button (2) to reticle ON/OFF.
	RETICLE COLOR CONTROL	To change the reticle color, push button (4). There are four colors available of the reticle: black, white, red and cyan.
4	RETICLE PATTERN CONTROL	To scroll through the reticle types, push and hold button (4). There are five types of fixed reticles available: "Dot 4 MOA", "Line Dot", "Cross Center Dot", "Cross", and "Crosshair".
2, 4	RETICLE POSITION ZEROING	Simultaneously pushing buttons (2) and (4) zeroes the reticle position to the center of the screen.
	LEFT, RIGHT	Use the LEFT (4) and RIGHT (2) buttons to navigate through the items when in menu.
	SELECTION	Push the SELECTION button (5) to view the settings available for the item selected.
5	MAIN MENU	Depressing and holding button (5) will bring up the Main Menu. The menu includes the following functions: Palette, Reticle, Boresight, Enhancement, Store Image, Settings and Power Down.
	UCMNUC/FFC PROCESS INTERRUPTION	Pushing button (5) when the countdown is on the screen will cancel the UCMNUC/FFC and the shutter will not interrupt viewing.
6	TAKE IMAGE	Momentarily Press of the Power button will take an image once the unit is operating.
	POWER OFF	Pressing and holding the Power button down for 3 seconds will turn off the unit.
7	BLUETOOTH (optional)	The Zeus Pro has Bluetooth® wireless capability and can directly interface with most smart phones with the potential for engaging a series of current and future applications.
8	GPS (optional)	Turn the GPS ON or OFF.

3.2.2 MAIN MENU

Most setup options can be accessed from the MAIN MENU.

To display the MAIN MENU, push and hold down the MENU button (5) on the control panel (Figure 3-10).

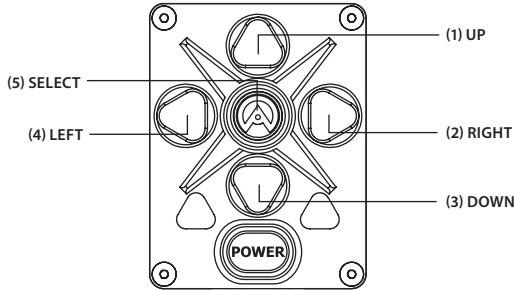

FIGURE 3-11. MAIN MENU NAVIGATION BUTTONS

Once the MAIN MENU is displayed (Figure 3-12), use the UP(1) and DOWN (2) buttons (Figure 3-11) to navigate through the items on the menu.

Push the SELECT button to view the settings available for the item selected.

NOTES:

Navigate through submenu items by pushing the UP (1) and DOWN (3) button except where otherwise expressly indicated.

The LEFT (4) and RIGHT (2) buttons are available only when specified on the menu screen with < > symbols.

After a menu item is selected with an arrow pointer, push the SELECT button (5) to make the selected setting/ activate the selected function.

Select the EXIT item and then push the SELECT button (5) to return to the MAIN MENU.

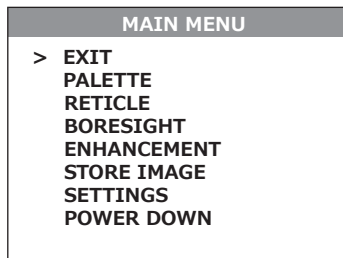

FIGURE 3-12. MAIN MENU

Palette Menu

The PALETTE menu (Figure 3-13) allows you to select from a choice of temperature imaging modes: White Hot, Black Hot, Sepia, Fusion, Rainbow, and Rain.

The palettes act as color templates for visualization of temperature changes in the scene.

To navigate through the items on the PALETTE menu, press the UP/DOWN buttons.

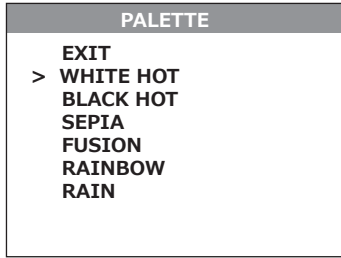

FIGURE 3-13. PALETTE MENU

NOTE:

The most popular are White Hot and Black Hot palettes usually known as inversion. White hot mode is good for spotting targets and black hot mode is most useful for situational reading.

NOTE:

Training and experience are required to quickly and properly interpret the thermal image being displayed.

Reticle Menu

The RETICLE menu (Figure 3-14) allows for reticle selection from a choice of reticle patterns: "Dot 4 MOA", "Line Dot", "Cross Center Dot", "Cross", "Crosshair", or "No Reticle", and position with no aiming mark.

To navigate through the items on the RETICLE menu, push and hold down the LEFT/RIGHT button.

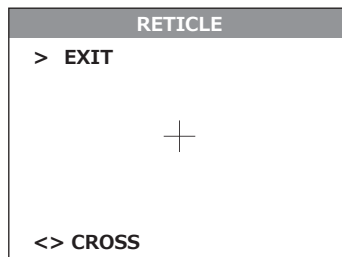

FIGURE 3-14. RETICLE MENU

Boresight Menu

The BORESIGHT function allows changing the reticle position on the display. Figure 3-15 shows the boresight screen.

Push the buttons UP/DOWN and RIGHT/LEFT to shift the reticle on the display up/down and to the right/left, respectively. Depressing and holding the UP/DOWN and RIGHT/LEFT buttons will cause accelerated movement of the reticle in 4 pixel increments.

Every time one of these buttons is pushed, the reticle shifts a single pixel increment corresponding to the minimum boresight correction value, and the center of impact on the target moves specified windage/elevation boresight increment in the direction opposed to the direction of the reticle shift.

NOTE:

Remember that the **center of impact on the target shifts in direction opposed to the direction of the reticle shift**. So, to bring the center of impact to the right/left and up/down, you must shift the reticle to the left/right and down/up, respectively.

To control the reticle shifting, see the running coordinate of the reticle center that is printed in the lower left hand corner of the display.

NOTE:

For display coordinates, the origin is the center of the display. The running coordinate of the reticle is the number of incremental shifts of the reticle from the display center. The minus sign appears before the displayed number when the reticle shifts left or down (the center of impact on the target shifts right or up, respectively).

Push and hold down the combination of buttons (LEFT+RIGHT) to reset to zero azimuth and elevation.

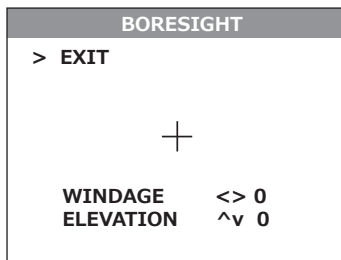

FIGURE 3-15. BORESIGHT MENU

Pushing the combination of buttons (LEFT+RIGHT) to reset to zero azimuth and elevation the reticle will shift to the display center.

Enhancement Menu

The ENHANCEMENT menu (Figure 3-16) settings allow the user to take advantage of advanced signal processing algorithms to improve the quality of the picture that is being viewed under a variety of different thermal environments.

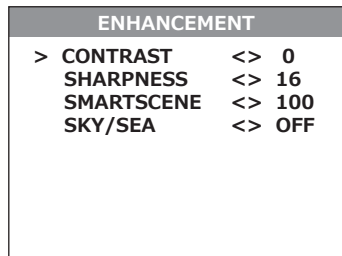
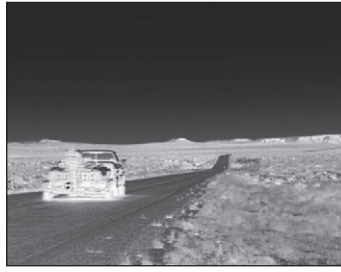

FIGURE 3-16. ENHANCEMENT MENU

CONTRAST - Active Contrast Enhancement (ACE) – a digital contrast correction that allows for a smart scene optimization based on dynamic adjustments where a variety of contrast levels occur depending on relative scene temperature. The adjustment range is from -8 to +8 with default value 0. Lower values will make hotter objects get more contrast and higher values will make a colder objects get more contrast.



CONTRAST -8



CONTRAST +8

FIGURE 3-17. DIGITAL CONTRAST CORRECTION

SHARPNESS - Second Generation Digital Detail Enhancement (DDE) – a sharpness correction that is digitally enhances the picture to present clearer imagery, significantly improves edge sharpening and further reduces image noise. The adjustment range is from -20 to +100 with default value 16. Lower values will create an object image with softer edges. Higher values will make an object sharper, enhance details and will further increase the signal to noise ratio.



SHARPNESS -20



SHARPNESS +100

FIGURE 3-18. SHARPNESS CORRECTION

SMART SCENE - Smart Scene Optimization (SSO) – a fine-tuning computational correction that significantly improves an overall visual acuity for targets that have thermal signatures similar to a surrounding background. Higher values provide a more linear automatic gain control behavior and objects with similar, but not the same temperature can be differentiated with greater accuracy. The adjustment range is from 0 to 100 with default value 100.



SMART SCENE 0



SMART SCENE 100

FIGURE 3-19. SMART SCENE OPTIMIZATION

SKY/SEA - Information Based Histogram Equalization (IBHEQ) – a “Sky/Sea” enhancement – information based environment dependent algorithm that automatically adjusts camera gain and excludes pixels determined to not contain critical information, specifically helpful in scenes with lots of sky or water. Turning the “Sky/Sea” enhancement ON will improve the contrast for the area of interest but at the possible loss of some scene content.

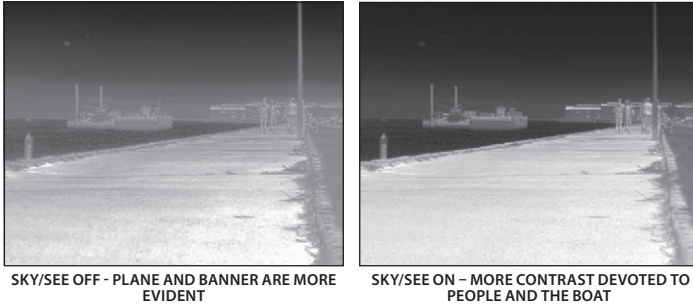

FIGURE 3-20. "SKY/SEA" ENHANCEMENT

Store Image Menu

The STORE IMAGE menu (Figure 3-21) allows the operator to take, review and delete all images in the camera. When previewing images, the image counter will show the current number of still images versus the total number of images in the camera.

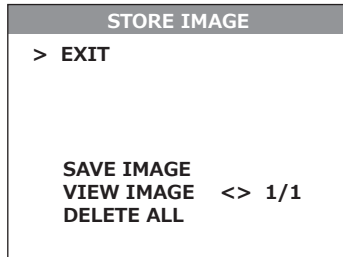

FIGURE 3-21. STORE IMAGE MENU

Settings Menu

The SETTINGS menu (Figure 3-22) allows of direct changes of the contrast, brightness, video standard, compass calibration and temperature scale settings (in certain models?), as well as to restore the settings to their factory defaults. The Firmware (FW) revision number is listed at the bottom of the menu display.

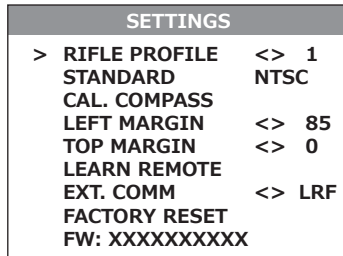

FIGURE 3-22. SETTINGS MENU

RIFLE PROFILE

Supports 3 individual rifle profiles that keep independent boresight settings.

STANDARD

Changes the video output standard between NTSC and PAL.

CALIBRATE COMPASS

Select to calibrate compass. When selected, rotate the camera in all directions for best calibration results.

LEFT MARGIN

Shifts the screen left - right.

TOP MARGIN

Shifts the screen up - down.

LEARN REMOTE

Learns the remote channel and encryption. Select this to pair a new remote with the camera.

EXTERNAL COMMUNICATIONS

Select between Laser range finder and external Personal Computer connection. You need to restart the camera after the selection.

FACTORY RESET

Resets the camera to factory defaults.

Power Down Menu

The POWER DOWN menu (Figure 3-23) allows the user to turn the camera off or to set it in standby mode so it can be awakened from the wireless remote.

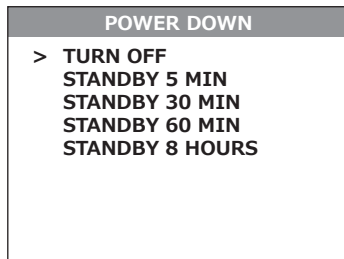

FIGURE 3-23. POWER DOWN MENU

NOTE:

After configuration is complete, select EXIT on the MAIN MENU and push the SELECT button to leave the MAIN MENU. All settings will be saved.

3.2.3 DISPLAY INDICATIONS

The screen status view (Figure 3-24) shows the status messages on the screen.

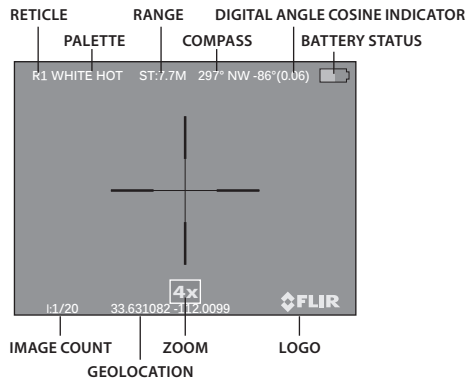

FIGURE 3-24. STATUS VIEW

3.3 OPERATING PROCEDURES

3.3.1 OPERATING

**WARNING:**

Always make sure your firearm is unloaded before you place the scope on the firearm. Reconfirm that the chamber is empty if you stop the procedure then resume later. Safe handling rules should be followed at all times.

CAUTION:

DO NOT force the equipment controls past their stopping points.

CAUTION:

To prevent thermal damage to the equipment, never point it, either powered or not, directly at the sun or any other source of high intensity light that the unprotected human eye cannot tolerate (such as a welding arc). To prevent inadvertent exposure to these sources, never leave the equipment without the objective lens cap secured.

Operating procedures are as follows:

1. Remove the Zeus PRO from the carrying case.
2. Install the Zeus PRO on the weapon's Picatinny/Weaver rail.
3. Verify that the Zeus PRO is securely mounted to the weapon.
4. Remove the objective lens cap.
5. Point the equipment at an object.
6. Activate the Zeus PRO by pressing the POWER button. After approximately 3 sec, video of the thermal scene should appear.
7. Adjust the Zeus PRO for your eyesight by turning the eyepiece focus ring CW up to the stop, and then CCW until the display and symbols (such as the reticle) are as clear as possible. Bring the object into focus by turning the objective focus ring (CW for far focus, CCW for near focus).

NOTE:

The total diopter adjustment range is covered with 2 turns of the eyepiece focus ring.
The total focus range is covered with 3/4 turn of the objective focus ring.

8. Using the buttons on the control panel (Figure 3-25), configure the Zeus PRO to adapt it to your situation.

For more information on operational setting procedures, see Part 3.2 (Controls and Display Indications).

- A. Adjust the brightness of the display for your comfort.

Momentarily push the brightness adjustment buttons to increase (1) /decrease (3) the display brightness by one level at a time until you reach your desired brightness level.

- B. Use UCMNUC/FFC (User Controlled Manual Non Uniformity Correction/Flat-Field Correction) function to improve image quality. As the camera including the detector heats up during the use, the detector pixels will drift. The pixels do not drift uniformly. The camera software compensates for the drift up to an accurate position point, but when the limit is reached the UCMNUC/FFC function is triggered. A uniform mechanical shutter is placed between the lens and the detector for a moment and the signal is processed.

Push and hold the two brightness control buttons (1) and (3) at the same time to manually trigger a User Controlled Manual Non Uniformity Correction/Flat-Field Correction.

If necessary, interrupt the automatic UCMNUC/FFC process by pushing the central button (5) on the control panel during the 5 second countdown which appears at the bottom of the display.

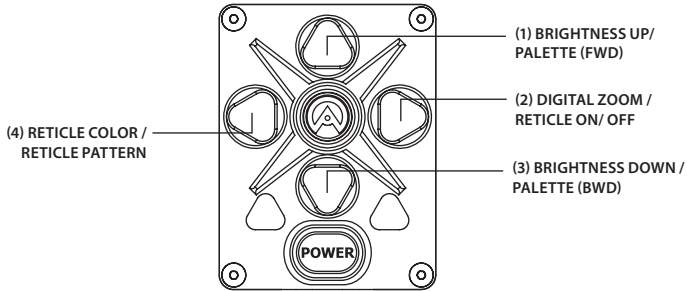

FIGURE 3-25. SETTING BUTTONS

C. Adjust the necessary adjustment using the MAIN MENU. See Part 3.2.2 (Using the MAIN MENU).

NOTE:

After configuration is complete, select EXIT on the MAIN MENU and push the SELECT button to leave the MAIN MENU. All settings will be saved.

D. Select the color of the reticle.

Momentarily push the reticle color control button (4) to select among black, white, red, and cyan.

E. Turns reticle ON/ OFF.

Push and hold button (2) to turn reticule ON or OFF.

F. Select a reticle pattern.

Push and hold button (4) to select from a choice of reticle patterns: "Dot 4 MOA," "Line Dot," "Cross Center Dot," "Cross," "Crosshair" (Figure 3-26).

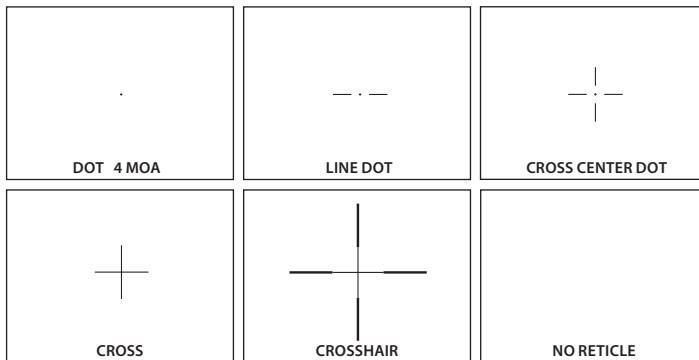

FIGURE 3-26. RETICLE PATTERNS

NOTE:

The reticles appear in the most recently saved position on the display.

G. Use digital zoom to magnify the central area of the displayed scene.

Momentarily push the zoom control button (2) to slowly magnify into the displayed scene. The X1, X2, X4, X8 symbols (maximum zoom factor is dependent of model) will appear in the lower part of the display.

NOTE:

Digital zoom allows distant objects to appear larger; however, the resolution will be compromised.

NOTE:

Zooming does not affect the boresight.

NOTE:

Digital zoom and reticle color control help target detection and discrimination.

9. To align the barrel of the weapon, place the reticle on the desired target. To allow for the bullet's travel (i.e. bullet drop, windage, and the target mobility), use the boresight adjusting buttons.

CAUTION:

DO NOT leave the equipment activated when not in use.

3.3.2 BORE SIGHTING THE ZEUS PRO



WARNING:

Always make sure your firearm is unloaded before you place the scope on the firearm. Reconfirm that the chamber is empty if you stop the procedure then resume later. Safe handling rules should be followed at all times.

NOTE:

The Zeus PRO must be zeroed each time it is mounted to a **new** weapon.

NOTE:

When reticle at (0-0) coordinates there is an incline of 15 arc minutes for the scope's optical axis.

Boresight the Zeus PRO as follows:

1. Locate a target at the fire adjustment range (100yd or 100m for example).
2. Turn on the Zeus PRO.
3. Adjust the eyepiece and focus the objective lens to sharpen the image of the target.
4. Adjust the brightness of the display.
5. Select a reticle pattern.
6. Take aim by centering the reticle on the target and fire a series of shots (3-4).
7. Find the point of impact and measure its vertical and horizontal deviations from the center of the target.
8. Work out the values of boresight correction required to compensate for the measured deviation of the point of impact from the center of the target. Table 3-3 contains examples of calculating boresight correction values.

**TABLE 3-3. EXAMPLE OF CALCULATING BORESIGHT CORRECTIONS
(100YD AND 100M FIRE RANGES)**

MODEL		ZEUS PRO 336 2-8X30	ZEUS PRO 336 4-16X50	ZEUS PRO 336 8-32X100
Boresight Increment *		0.9in/100yd 2.5cm/100m	0.5in/100yd 1.4cm/100m	0.25in/100yd 0.7cm/100m
Measured Windage/Elevation Deflection of the POI from the Target Centre (for example)		5in / 2in (13cm / 5cm)	4in / 3in (10cm / 8cm)	2in / 1in (5cm / 2cm)
Correction Value	Windage	5/0.9≈5 shifts (13/2.5≈5 shifts)	4/0.5≈7 shifts (10/1.4≈7 shifts)	2/0.25≈7 shifts (5/0.7≈7 shifts)
	Elevation	2/0.89≈2 shifts (5/2.5=2 shifts)	3/0.52≈5 shifts (8/1.4≈5 shifts)	1/0.26≈4 shifts (2/0.7≈3 shifts)
MODEL		ZEUS PRO 640 1-8X30	ZEUS PRO 640 2-16X50	ZEUS PRO 640 4-32X100
Boresight Increment *		1.7in/100yd 4.6cm/100m	1in/100yd 3cm/100m	0.5in/100yd 1.5cm/100m
Measured Windage/Elevation Deflection of the POI from the Target Centre (for example)		6in / 9in (15cm / 23cm)	2in / 4in (5cm / 10cm)	3in / 2in (8cm / 5cm)
Correction Value	Windage	6/1.7≈3 shifts (15/4.6≈3 shifts)	2/1=2 shifts (5/3≈2 shifts)	3/0.5=6 shifts (8/1.5≈5 shifts)
	Elevation	9/1.7≈5 shifts (23/4.6≈5 shifts)	4/1=4 shifts (10/3≈3 shifts)	2/0.5=4 shifts (5/1.5≈3 shifts)

* 1) For PAL resolution (768x574)

2) To calculate boresight increment value for a fire range R different from 100 yards, use the coefficient $R/100$. So at a range R (in yards) the boresight increment is:

- $0.9 \times R/100$, in — for Zeus PRO 336 3-8x30;
- $0.5 \times R/100$, in — for Zeus PRO 336 4-16x50;
- $0.25 \times R/100$, in — for Zeus PRO 336 8-32x100;
- $1.7 \times R/100$, in — for Zeus PRO 640 1-x30;
- $R/100$, in — for Zeus PRO 640 2-16x50;
- $0.5 \times R/100$, in — for Zeus PRO 640 4-32x100.

3) To calculate boresight increment value in metric units for a fire range R different from 100m, use the coefficient $R/100$. So at a range R (in meters) the boresight increment is:

- $2.5 \times R/100$, in — for Zeus PRO 336 3-8x30;
- $1.4 \times R/100$, in — for Zeus PRO 336 4-16x50;
- $0.7 \times R/100$, in — for Zeus PRO 336 8-32x100;
- $4.6 \times R/100$, in — for Zeus PRO 640 1-x30;
- $3 \times R/100$, in — for Zeus PRO 640 2-16x50;
- $1.5 \times R/100$, in — for Zeus PRO 640 4-32x100.

9. Use the BORESIGHT MENU to apply corrections required to bring the point of impact as close as possible to the center of the target. See Part 3.2.2 (Using the MAIN MENU).

- A. Use LEFT and RIGHT buttons to adjust for windage. Moving the reticle in the positive direction (to the right) will move the point of impact to the left. Moving the reticle in the negative direction (to the left) will move the point of impact to the right.
- B. Use UP and DOWN buttons to adjust for elevation. Moving the reticle in the positive direction (up) will move the point of impact down. Moving the reticle in the negative direction (down) will move the point of impact up.

10. Fire a series of shots to check the boresight.
11. After completing the boresight adjustment procedure you can use RIFLE PROFILE function of Setting menu to save the boresighted reticle position map in the "Rifle Profile" tab. This can be done for the same scope equipped to up to 3 different rifles (Profile 1, Profile 2, and Profile 3).
12. Turn off the Zeus PRO and place the cap over the objective lens.

3.3.3 ZEUS PRO SHUT-DOWN

NOTE:

Shut down the Zeus PRO properly to avoid losing unsaved settings and data.

Shut-down the Zeus PRO as follows:

1. Be sure to save your settings and data.
2. Turn off the Zeus PRO.
3. Replace the cap on the objective lens.
4. Disconnect the cable (if applicable).
5. Place the cap on the connector.
6. Dismount the Zeus PRO from the weapon.
7. Remove the batteries.

CAUTION:

Do not store the Zeus PRO with the batteries still in it.

8. Store the Zeus PRO and all accessories in the carrying case.

PREVENTIVE MAINTENANCE AND TROUBLESHOOTING

4.1 PREVENTIVE MAINTENANCE CHECKS AND SERVICES

4.1.1 PREVENTIVE MAINTENANCE CHECKS AND SERVICES (PMCS)

Table 4-1 Preventive Maintenance Checks and Services (PMCS), has been provided so that you can keep your equipment in good operating condition.

Perform functional tests in the order listed in Table 4-1.

Operating procedures are detailed in Chapter 3.

Explanation of Table Entries:

SEQ NO. column. Sequence numbers are for reference and appear in the order required to perform checks and services.

LOCATION/ITEM TO CHECK/SERVICE column. Indicates the location and the item to be checked or serviced.

PROCEDURE column. Details the check/ service procedure.

NOT FULLY MISSION CAPABLE IF ... column. Indicates what faults will prevent your equipment from operating successfully.

TABLE 4-1. PREVENTIVE MAINTENANCE CHECKS AND SERVICES

SEQ NO.	LOCATION ITEM TO CHECK/SERVICE	PROCEDURE	NOT FULLY MISSION CAPABLE IF ...
BEFORE OPERATION CHECKS			
1	Completeness	Open storage/carrying case and inventory items by means of comparing with the data specified in this manual.	Missing items.
2	Soft Carrying Case	Shake out loose dirt or foreign material. Inspect for tears, cuts, excess wear or damage.	
3	Body	Inspect for cracks or damage. Scratches and gouges are OK if operation is not affected. Inspect for missing parts. Clean as required.	Cracked or damaged. Missing parts.
4	Objective Lens Cap	Inspect for cuts, tears and dirt. Clean as required.	Cap is torn or cut. Cap is not secured to the housing of the lens.

TABLE 4-1. CONTINUED

SEQ NO.	LOCATION ITEM TO CHECK/SERVICE	PROCEDURE	NOT FULLY MISSION CAPABLE IF ...
5	Eyecup	Inspect for cuts, tears and dirt. Inspect for torn, bent or improperly fitting eyecup. Clean as required.	Cup is torn or cut.
6	Battery Compartment and Cap	Inspect for corrosion, moisture, and corroded or defective contacts. Inspect for cap damage or retainer breaks. Inspect rubber gasket for damage.	Contacts are damaged or corroded. Retainer is broken. Cap or rubber gasket is damaged.
7	Lenses	Inspect for cleanliness, scratches, chips or cracks. Clean as required.	Chipped or cracked. Scratches hinder vision through the equipment.
8	Objective Focus Ring	Rotate objective focus ring to ensure it is not too tight or too loose. Range is approximately 3/4 turns.	Ring gets stuck, is too loose, or adversely affects the user's ability to properly focus the objective lens.
9	Eyepiece Focus Ring	Rotate eyepiece focus ring to ensure the ring is not too tight or too loose. Range is approximately 2 turns.	Ring gets stuck, is too loose, or adversely affects the user's ability to properly adjust the diopter.
10	Connector	Inspect for corrosion, moisture, and corroded or defective contacts. Inspect for cap damaged or retainer breaks.	Contacts are damaged or corroded. Cap is damaged. Retainer is broken.
11	Mount	Inspect for damage or corrosion, for missing parts. Check for proper operation and attachment security.	Damaged. Missing parts. Clamping device is inoperative.
12	Remote Control Unit	Check for damage and missing parts. Check Velcro tape for wear.	Damaged. Missing parts.
13	Video Cable	Inspect for damage. Inspect the cable connector for corrosion, moisture, and corroded or defective contacts. Clean as required.	Damaged.
14	Platform Ring (optional)	Inspect for damage, corrosion, or missing parts. Check for proper operation. Clean as required.	Damaged. Missing parts.

OPERATIONAL CHECKS

NOTE:

For a complete operational checking, it is necessary to connect a video monitor to the Zeus PRO.

15	Turn-pull Switch	Install the batteries. Remove the objective lens cap. Point the equipment at an object. Turn the equipment on. Look for a thermal image on the display. Look for a flashing battery icon in the eyepiece viewing area.	No thermal image. Battery icon is flashing (indicates a low battery).
16	Control Board	Ensure the scope is responsive to control buttons.	Unresponsive buttons.
17	Remote Control	Ensure the scope is responsive to remote control buttons.	Unresponsive buttons.
18	Video Cable	Connect an external monitor to the scope. Point the equipment on an object. Turn the equipment on. Look for an image on the monitor. Turn off the scope. Disconnect the monitor.	No image.
19	Boresight	Test boresight as per Part 4.3.3.	

POST-CHECK PROCEDURES

- Turn off the equipment.
- Replace the objective lens cap.
- Remove the batteries.
- Return the equipment and all accessories to the carrying case.

4.2 OPERATOR TROUBLESHOOTING

The purpose of troubleshooting is to identify the most frequent equipment malfunctions, probable causes, and corrective actions required.

Table 4-2 lists the common malfunctions that may be found during the operation or maintenance of the Zeus PRO. Perform the tests/inspections and corrective actions in the order listed.

This table does not list all of the malfunctions that may occur with your device, or all of the tests and corrective actions that may be necessary. If you experience an equipment malfunction that is not listed, or is not fixed by the corrective actions listed in the table, please contact Armasight's Customer Service center.

TABLE 4-2. OPERATOR TROUBLESHOOTING

MALFUNCTION	PROBABLE CAUSE/ TEST/INSPECTION	CORRECTIVE ACTION
The scope fails to activate.	Batteries are missing or improperly installed.	Insert batteries or install correctly.
	Batteries are dead.	Replace the batteries.
	Batteries, surfaces or contacts are dirty or corroded.	Clean the contact surfaces with a pencil eraser and/or alcohol and cotton swabs.
	Remote control unit is damaged.	Please contact Customer Support.
	Remote control battery is dead.	Replace the battery as per Part 4.3.4.
The equipment is damaged.	The equipment is damaged.	Please contact Customer Support.
The scope is not responsive to control buttons.	The equipment is damaged.	Please contact Customer Support.
Remote control does not work.	Battery is missing or improperly installed.	Insert battery or install correctly.
	Battery is dead.	Replace the battery.
	Battery surfaces or contacts are dirty or corroded.	Clean the contact surfaces with a pencil eraser and/or alcohol and cotton swabs.
	Remote control unit is damaged.	Please contact Customer Support.
Poor image quality.	Check objective lens and eyepiece focus.	Refocus.
	Check for fogging or dirt on objective lens and eyepiece.	Clean the lenses as detailed in Part 4.3.2.
	The equipment is damaged.	Please contact Customer Support.
No image on an external monitor.	Video cable is damaged.	Replace the video cable with a new one. Please contact Customer Support.
	The equipment is damaged.	Please contact Customer Support.
Hindered rotation of the battery cap.	Dirty cap thread.	Clean the thread.
	Damaged cap thread.	Replace the cap with a new one. Please contact Customer Support.
Light is visible around eyecup.	Check eyecup resilience.	If the eyecup is defective, please contact Customer Support.

4.3 MAINTENANCE

4.3.1 GENERAL

The Zeus PRO operator maintenance consists of operational tests, inspections for unit serviceability, cleaning and mounting procedures, corrective actions (troubleshooting and replacement of a limited number of parts). Maintenance instructions covered elsewhere in this manual (PMCS, troubleshooting, etc.) are not repeated in this section.

CAUTION:

The Zeus PRO is a precision electro-optical instrument and must be handled carefully at all times to prevent damage.

CAUTION:

DO NOT dismantle the equipment.

4.3.2 CLEANING PROCEDURES

Clean the Zeus PRO and optional items as follows:

1. Gently brush off any dirt from the equipment using only a clean, soft cloth.
2. Moisten the cloth with fresh water and gently wipe the external surfaces (except for optical surfaces).
3. Dry any wet surfaces (except for optical surfaces) with another clean, dry soft cloth.
4. Using a lens brush, carefully remove all loose dirt from optical surfaces (objective lens and eyepiece).
5. Slightly dampen a cotton swab with ethanol and lightly and slowly wipe optical surface. Clean the optical surface by circular movements from the center to the edge, not touching the lens holder and changing cotton swab after each circular stroke. Repeat until the optical surface is clean.
6. Clean the battery contact surfaces and contact springs with a pencil eraser and/or alcohol and cotton swabs.

CAUTION:

Thoroughly dry each item before replacing into the storage/carrying case.

4.3.3 BORE SIGHTING

Perform the Zeus PRO bore sighting:

- When the Zeus PRO is mounted to a new weapon for the first time;
- After repair of the Zeus PRO/ weapon;
- As the need arises (in case of systematic inaccuracy and missing the target).

Refer to Part 3.3.2 for boresight procedure.

4.3.4 BATTERY REMOVAL AND REPLACEMENT

Refer to Part 3.1.1 for battery installation procedures.

Replace the remote control battery as follows:

1. Using a screwdriver, unscrew the four screws (A, Figure 4-1) that secure the cover to the bottom of the unit. Remove the cover.

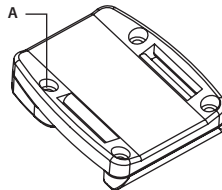

FIGURE 4-1. ADVANCED WIRELESS REMOTE CONTROL BATTERY INSTALLATION

2. Replace the battery with new one (CR2032, 3V). Install the battery, aligning their polarity markings (+/-) with those embossed on the compartment.
3. Replace the cover and tighten the screws (A).

4.4 RETURN INSTRUCTIONS

For service, repair or replacement, please email: service@armasight.com.

To assist the Service Representative (SR) with determining if the item is repairable, please provide the following information:

1. Serial Number of the defective item (engraved on bottom of the equipment).
2. Thorough description of the malfunction, defect or damage.
3. An explanation of how the malfunction, defect or damage occurred, if known.

If the SR determines that the item is under warranty or should be returned for repair, a Return Material Authorization number (RMA#) will be provided.

When returning the Zeus PRO for service or repair, the following procedures should be followed to prevent any additional damage:

1. Make sure the scope is free of all contaminants such as dirt or any other foreign material.
2. Remove the batteries.
3. Place the cap over the objective lens.
4. Place the scope and accessories in the carrying case.

Place the scope and a copy of the test report or detailed description of the failure in a suitable packing/shipping container. Mark the package with the RMA#. Ship the fastest, traceable, prepaid means to:

Armasight Inc.
815 Dubuque Avenue,
South San Francisco, CA 94080,
USA.

A. PRODUCT WARRANTY REGISTRATION CARD

In order to validate the warranty on your product, Armasight must receive a completed Product Warranty Registration Card for each unit, or the user must complete warranty registration on our website (www.armsight.com). Please complete the included form and immediately mail it to our Service Center:

Armasight Inc.
 815 Dubuque Avenue
 South San Francisco, CA 94080
 USA

ARMASIGHT PRODUCT WARRANTY REGISTRATION CARD

PRODUCT INFORMATION

Product Name _____ Purchased From _____

Purchase Date _____ Product Serial # _____

CUSTOMER INFORMATION

Name _____

Address _____

City _____ Country _____ Zip _____

Day Phone # _____ Home Phone # _____

E-mail address _____

.....
 Customer Signature Required

B. LIST OF SPARE PARTS

The parts authorized by this list of spare parts are required for operator maintenance. The list includes parts that must be removed before replacing authorized parts.

The PART NO. column indicates the primary number used by the manufacturer, which controls the design and characteristics of the item in terms of its engineering drawings, specifications, standards, and inspection requirement, to identify an item.

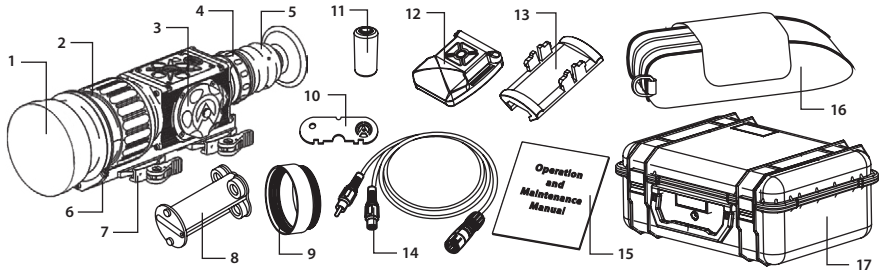

FIGURE B-1. ZEUS PRO SPARE PARTS LIST

TABLE B-1. ZEUS PRO SPARE PARTS LIST

ITEM NO.	DESCRIPTION	PART NO.
1	30mm Objective Lens Cap	AZSPROLC30
-	50mm Objective Lens Cap	AZSPROLC50
-	100mm Objective Lens Cap	AZSPROLC100
2	30mm Objective Lens Assembly	AZSPROLA30
-	50mm Objective Lens Assembly	AZSPROLA50
-	100mm Objective Lens Assembly	AZSPROLA100
3	Battery Cap	AZSPRBC
4	Eyepiece Assembly	AZSPREPA
5	Eyecup	AZSPREC
6	Seating Rail	AZSPRSR
7	Mount	AZSPRQRM
8	Battery Cartridge	AZSPRBTCTR
9	Battery Box Extender Ring	AZSPRBBER
10	Armasight Key	AZSPRASK
11	CR123A Lithium Battery	ALT
12	Advanced Wireless Remote Control	ANVR000001
13	Picatinny Adapter for Advanced Wireless Remote Control	ANRA000002
14	Video Cable	AZSPRVCB
15	Operation and Maintenance Manual	AZSPROMM
16	Carrying Case	AGSC000009
17	Hard Shipping/Storage Case	ANHCO00004
18	Side Picatinny/Weaver Rail (not shown)	AZSPRRRL
19	Connector Cap (not shown)	AZSPRCNCP



Armasight Inc.

815 Dubuque Avenue
South San Francisco
CA 94080, USA

Phone: (888)959-2259

Fax: (888)959-2260

Intl Phone/Fax: (650)492-7755

info@armasight.com



WARNING!

This product contains natural rubber latex which may cause allergic reactions! The FDA has reported an increase in the number of deaths that are associated with an apparent sensitivity to natural latex proteins. If you are allergic to latex, it is a good idea to learn which products contain it and strictly avoid exposure to those products.

www.armasight.com