

## Data Sheet

# E2G Pressure Transducer

### FEATURES

- Ranges vac through 20,000 psi
- IP66/67 Ingress rating
- Wide selection of electrical & process connections
- Customizable configurations
- External magnetic offset & span adjustment
- Barometric pressure ranges available (standard and custom ranges)

### TYPICAL USES

- Off-Road equipment
- Construction machinery
- HVAC/Refrigeration
- Compressor control
- Pump monitoring
- Agricultural equipment
- Diagnostic kits
- Engine monitoring
- Process automation & controls
- Hydraulic & pneumatic sensing

### PERFORMANCE SPECIFICATIONS

Reference Temperature:	70°F ±3.6°F (21°C ±2°C)
Static Accuracy:	±0.25% of span, ±0.50% of span, ±1.0% of span, (0-1.5# Range only available in ±0.5% and 1.0% accuracy) Terminal Point Method includes: hysteresis, linearity, repeatability, offset and span
Stability:	±0.25% year at reference conditions

### ENVIRONMENTAL SPECIFICATIONS

Thermal Coefficients:	Offset: ±0.005% /°F from -40°F to 257°F (±0.009% /°C from -40°C to 125°C) Span: ±0.005% /°F from -40°F to 257°F (±0.009% /°C from -40°C to 125°C)
Temperature Limits:	Storage: -58°F to 257°F (-50°C to 125°C) Operating: -40°F to 257°F (-40°C to 125°C) Media: -40°F to 257°F (-40°C to 125°C)
Humidity:	0-100% (non-condensing)

### FUNCTIONAL SPECIFICATIONS

Response Time (Output)	4 ms
Gauge/Compound Pressure Ranges:	VAC to 20,000 psig
Shock:	80g, 6 ms, Haversine
Vibration:	Random: 10g RMS 20-2000 Hz
Absolute Pressure Ranges:	0 to 500 psia
Proof Pressure:	1.2× - 2× (See Table 1 on page 2)
Burst Pressure:	3× - 8× (See Table 1 on page 2)

TrueAccuracy



E2G  
Pressure Transducer



### KEY BENEFITS

- Highly configurable
- Easy calibration of offset and span

### ELECTRICAL SPECIFICATIONS

Circuit Protection:	Reverse polarity protected		
Output Signal:	Supply Voltage: (unregulated)		
	Min.	Max:	
	0-5 Vdc (3 Wire)	9 Vdc	36 Vdc
	1-5 Vdc (3 Wire)	9 Vdc	36 Vdc
	1-6 Vdc (3 Wire)	9 Vdc	36 Vdc
	0-10 Vdc (3 Wire)	14 Vdc	36 Vdc
	1-11 Vdc (3 Wire)	14 Vdc	36 Vdc
	0.1-5 Vdc (3 Wire)	9 Vdc	36 Vdc
	0.1-10 Vdc (3 Wire)	14 Vdc	36 Vdc
	0.5-4.5 Vdc (3 Wire)	9 Vdc	36 Vdc
4-20 mA (2 Wire)	9 Vdc	36 Vdc	
20-4 mA (2 Wire)	9 Vdc	36 Vdc	
Adjustability:	±5% of span non-interactive offset & span		
Supply Current:	<8 mA (Vout)		
Current Source/Sink for Voltage Output	1 mA (source)/ 0.1 mA (sink) MAX.		
Withstand/Breakdown	100 Vdc/Vac, optional 500 Vdc/Vac		

# Data Sheet

## E2G Pressure Transducer

### PHYSICAL SPECIFICATIONS

Ingress Rating: IP66 (NEMA 4X) (STD.)  
IP67 (IP69K Consult Factory)

### WETTED MATERIAL

Diaphragm:	Sensor:	Material:
	A	17-4PH Stainless steel
	B	316L Stainless steel
	C	316L Stainless steel, liquid isolated
	D	A286

Process Connection: 316L Stainless steel

### NON-WETTED MATERIAL

Housing: 316L Stainless steel

### EMC TESTING

EMC: Directive 2014/30/EU, and EN61326-1, EN61326-2-3 (Industrial Env.)

Immunity:	Standard	Level
	61000-4-2 (ESD)	±4kV/±8kV (Contact/Air)
	61000-4-3 (Radiated RF)	10 V/m to 1GHz, 3 V/m to 2GHz, 1 V/m to 2.7GHz
	61000-4-4 (EFT/Burst)	±1kV (5/50ns, 5kHz)
	61000-4-5 (Surge)	±1kV, Earth to Shield over all I/O lines
	61000-4-6 (Conducted RF)	3V/ (0.15 to 80MHz)
	61000-4-8 (Line Freq. Magnetic)	30A/m

Emissions: EN 55011 (CISPR 11) Class A, Group 1 & FCC (47 CFR 15)

### APPROVALS

CE, UL/cUL Recognized component (UL 61010-1, CSA 22.2 61010-1), Electrical Equipment for Measurement, Control, and Laboratory Use.

### TABLE 1: PROOF & BURST PRESSURE MULTIPLIERS

Sensor Range	A Sensor - 17-4PH SS		B Sensor - 316 LSS		Sensor C - 316L SS ISO		Sensor D - A286	
	Proof	Burst	Proof	Burst	Proof	Burst	Proof	Burst
<b>(psi)</b>								
1.5					2X	5X		
5					3x	5x		
10					2x	5x		
15					2x	5x		
30					2x	5x		
45	2x	8x	1.5x	8x	2x	5x		
50	2x	8x	1.5x	8x	2x	5x		
60	2x	8x	1.5x	8x	2x	5x		
75	2x	8x	1.5x	8x	2x	5x		
100	2x	8x	1.5x	8x	2x	5x		
150	2x	8x	1.5x	8x	2x	4x		
200	2x	8x	1.5x	8x	2x	3x		
300	2x	8x	1.5x	8x	2x	3x		
500	2x	8x	1.2x	5x	3x	4x		
750	2x	8x	1.2x	5x				
1000	2x	8x	1.2x	5x				
1500	2x	8x	1.2x	5x				
2000	2x	8x	1.2x	5x				
3000	2x	5x	1.2x	5x				
5000	1.5x	5x	1.2x	5x			1.5x	5x
7500	1.5x	3x					1.5x	5x
10000	1.2x	3x					1.2x	5x
15000	1.2x	3x					1.2x	5x
20000	1.2x	3x					1.2x	5x
<b>(Compound)</b>								
VAC#					2x	5x		
V&15#					2x	5x		
V&30#					2x	5x		
V&45#	2x	8x	1.5x	8x				
V&60#	2x	8x	1.5x	8x	2x	5x		
V&100#	2x	8x	1.5x	8x				
V&150#	2x	8x	1.5x	8x	2x	4x		
V&200#	2x	8x	1.5x	8x				
V&300#	2x	8x	1.5x	8x	2x	3x		
<b>(psia)</b>								
15					2x	5x		
30					2x	5x		
50					2x	5x		
150					2x	4x		
300					2x	3x		
500					2x	3x		



### What Does It Mean?

Ashcroft's TruAccuracy™ specification is exclusively based on terminal point methodology instead of statistically derived schemes like 'best fit straight line'.

TruAccuracy™ means the Ashcroft E2G has ±0.25% of span accuracy out of the box. Zero and span setting errors are already included in the ±0.25% of span accuracy spec.

The E2G is ready to be installed with no additional calibration adjustments required.

A unit from another manufacturer advertised as ±0.25% best fit straight line may actually be a ±1.25% to ±2.25% device. Using best fit straight line method, the accuracy spec does not include zero and span setting errors, which can be as much as ±1.00% each.

# Data Sheet

## E2G Pressure Transducer

ORDERING CODE	Example:	E2G	B	3	C	F02	42	CC	X	10	F	100#	-XNH
<b>Model</b>													
E2G - General Purpose		E2G											
<b>Sensor Materials - See Table 2 on page 4 for more options</b>													
A - 17-4PH Stainless steel													
B - 316L Stainless steel		B											
C - 316L Stainless steel (liquid isolated)													
D - A286													
<b>Accuracy</b>													
3 - 0.25% span (not available with 1.5 psi range)		3											
5 - 0.50% span													
7 - 1.00% span													
<b>Calibration Chart</b>													
N - Without calibration chart													
C - With calibration chart		C											
<b>Pressure Connections - See Table 3 on page 5 for more options</b>													
F02 - (¼ NPT Female)		F02											
<b>Output Type</b>													
05 - 0-5 Vdc													
10 - 0-10 Vdc													
11 - 1-11 Vdc													
12 - 1-10 Vdc													
13 - 0.1-5 Vdc													
15 - 1-5 Vdc													
16 - 1-6 Vdc													
42 - 4-20 mA		42											
45 - 0.5-4.5 Vdc non-ratiometric													
00 - Custom													
<b>Electrical Connections - See Table 4 on page 6 for more options</b>													
CC - (½ NPT conduit w/cable)		CC											
<b>Mating Connector</b>													
M - With mating connector													
X - Without mating connector		X											
<b>Cable Length</b>													
Max cable length of 30ft for outputs 05, 10, 11, 12, 13, 15, 16 and 45. Max cable length of 99ft for outputs 24 and 42													
00 - No cable													
XX - 01 to 99		10											
<b>Unit of Length</b>													
F - Feet		F											
M - Meter													
N - Inches													
0 - No cable													
<b>Pressure Ranges - Coding example only, see Table 5 on page 7 for more options</b>													
100# - 100 psig		100#											
<b>Options (if choosing an option(s) must include an "X")</b>													
NN - Paper tag													
NH - Stainless steel tag													

Accessory	Part Number
Offset and Span Adjustment Magnet	266A143-01
Accessories must be ordered separately	

E2G Pressure Transducer

TABLE 2 - SENSOR PRESSURE RANGE														
psi	Sensor Material				bar	Sensor Material				inHg	Sensor Material			
	A 17-PH SS	B 316L SS	C 316 ISO	D A286		A 17-PH SS	B 316L SS	C 316 ISO	D A286		A 17-PH SS	B 316L SS	C 316 ISO	D A286
1.5#			•											
5#			•		400MB			•		10IM			•	
10#			•		600MB			•		20IM			•	
15#			•		1BR			•		30IM			•	
30#	•	•	•		1.6BR			•		50IM			•	
45#	•	•	•		2BR			•		100IM	•	•	•	
50#	•	•	•		2.5BR	•	•	•		200IM	•	•	•	
60#	•	•	•		4BR	•	•	•		300IM	•	•	•	
75#	•	•	•		6BR	•	•	•		500IM	•	•	•	
100#	•	•	•		10BR	•	•	•		1000IM	•	•		
150#	•	•	•		16BR	•	•	•		VACIM			•	
200#	•	•	•		20BR	•	•	•		V&30IM			•	
250#	•	•	•		25BR	•	•	•		V&60IM			•	
300#	•	•	•		40BR	•	•	•		V&100IM	•	•	•	
500#	•	•	•		60BR	•	•	•		V&200IM	•	•	•	
750#	•	•			100BR	•	•			30IMA			•	
1000#	•	•			160BR	•	•			50IMA			•	
1500#	•	•			200BR	•	•			100IMA			•	
2000#	•	•			250BR	•			•	200IMA			•	
2500#	•	•			400BR	•			•	300IMA			•	
3000#	•	•			600BR	•			•	500IMA			•	
5000#	•	•		•	1000BR	•				1000IMA			•	
7500#	•			•	VACBR			•		20&32IMA			•	
10000#	•			•	V&1BR			•		26&32IMA			•	
15000#	•			•	V&1.6BR			•		700&1100MBA			•	
20000#	•			•	V&2BR			•		900&1100MBA			•	
VAC#			•		V&4BR	•	•	•						
V&15#	•		•		V&6BR	•	•	•						
V&30#	•		•		1BRA			•						
V&45#	•	•	•		1.6BRA			•						
V&60#	•	•	•		2BRA			•						
V&100#	•	•	•		2.5BRA			•						
V&150#	•	•	•		4BRA			•						
V&200#	•	•	•		6BRA			•						
V&300#	•	•	•		10BRA			•						
15#A			•		16BRA			•						
30#A			•		20BRA			•						
50#A			•											
100#A			•											
120#A			•											
300#A			•											

E2G Pressure Transducer

TABLE 3 - PRESSURE CONNECTION DIMENSIONS

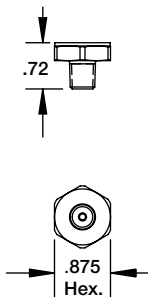
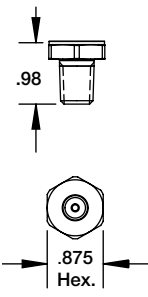
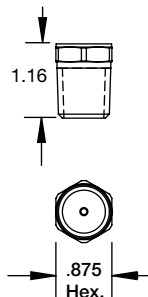
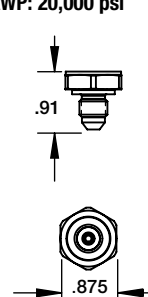
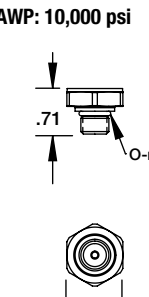
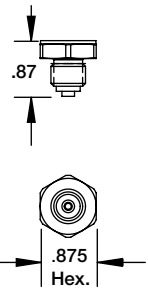
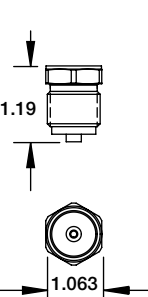
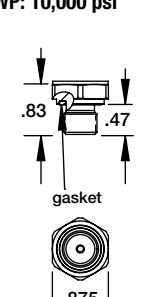
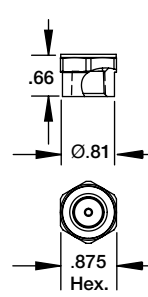
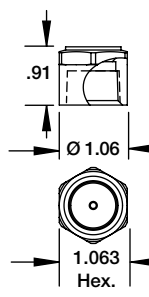
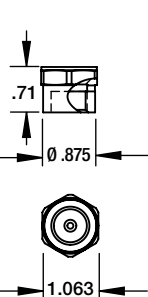
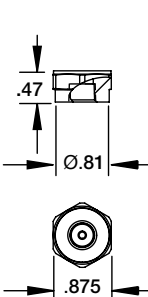
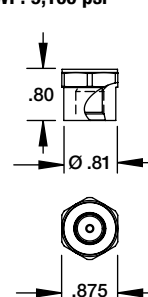
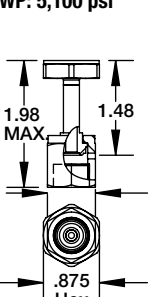
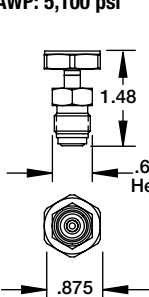
<p><b>1/8 NPT Male</b> Code: M01 MAWP: 20,000 psi</p>	<p><b>1/4 NPT Male</b> Code: M02 MAWP: 20,000 psi</p>	<p><b>1/2 NPT Male</b> Code: M04 MAWP: 10,000 psi</p>	<p><b>7/16-20 UNJF-3A 37° Flare (SAE AS4395)</b> Code: M76 MAWP: 20,000 psi</p>	<p><b>7/16-20 UNJF-2A SAE-Male (SAE J1926 O-Ring Boss seal)</b> Code: MEK MAWP: 10,000 psi</p>
				
<p><b>G1/4 B-Male (EN837-1)</b> Code: MG2 MAWP: 20,000 psi</p>	<p><b>G1/2 B Male (EN837-1)</b> Code: MG4 MAWP: 20,000 psi</p>	<p><b>G1/4 A-MALE (stud end DIN 3852-E G1/4)</b> Code: MGA MAWP: 10,000 psi</p>	<p><b>1/4-18 NPT Female</b> Code: F02 MAWP: 10,000 psi</p>	<p><b>1/2-14 NPT Female</b> Code: F04 MAWP: 5,000 psi</p>
				
<p><b>9/16-18 UNF-2B Female</b> Code: F09 MAWP: 25,000 psi</p>	<p><b>1/8 -27 NPT Female</b> Code: F01 MAWP: 10,000 psi</p>	<p><b>7/16-20 UNF-2B SAEJ1926</b> Code: FRW MAWP: 9,100 psi</p>	<p><b>1/4" VCR gland with 9/16-18 Female Swivel Nut</b> Code: FV2 MAWP: 5,100 psi</p>	<p><b>1/4" VCR gland with 9/16-18 Male Swivel Nut</b> Code: MV2 MAWP: 5,100 psi</p>
				

**Data Sheet**

**E2G Pressure Transducer**

**TABLE 4 - ELECTRICAL CONNECTION DIMENSIONS**

Maximum temperature range listed

**Metri Pack 3-Pin**

Code: GN – IP67 (NEMA 4X)  
-40°F to 185°F (-40°C to 85°C)

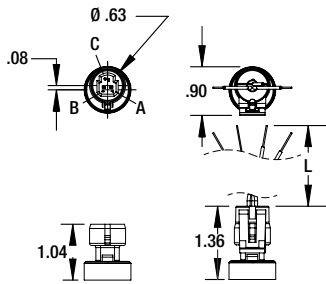

**AMP Superseal 3-Pin**

Code: AP – IP66 (NEMA 4X)  
-40°F to 185°F (-40°C to 85°C)

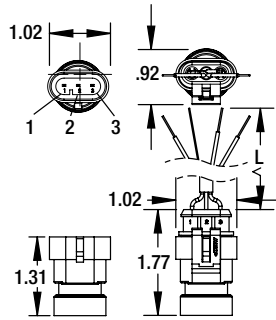

**Over-Mold Cable**

Code: FC, FV\* – IP67 (NEMA 4X)  
-40°F to 185°F (-40°C to 85°C)

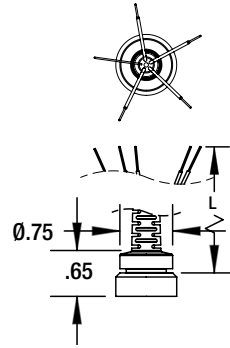

**M12 4-Pin**

Code: EW – IP66 (NEMA 4X)  
-40°F to 185°F (-40°C to 85°C)

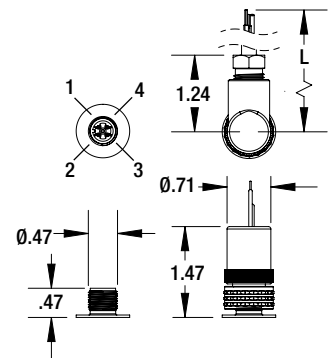

**DEUTSCH DT04 3-Pin**

Code: DT – IP66 (NEMA 4X)  
-40°F to 185°F (-40°C to 85°C)

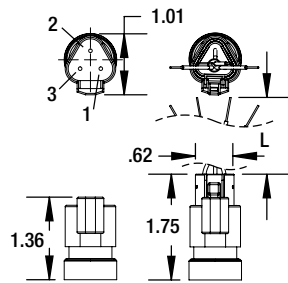

**Hirschmann EN 175301-803 Form A**

Code: DA – IP66 (NEMA 4X)  
-40°F to 185°F (-40°C to 85°C)

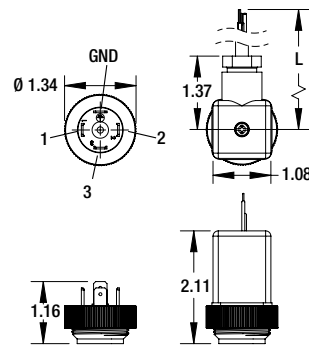

**Mini-Hirschmann**

Code: HM – IP66 (NEMA 4X)  
-40°F to 185°F (-40°C to 85°C)

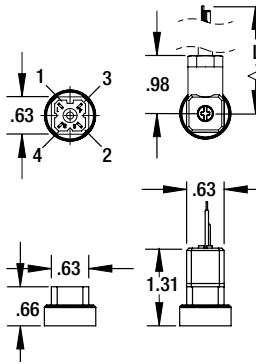

**MIL DTL 26482 8 4-Pin**

Code: B4 – No IP or NEMA rating  
-40°F to 221°F (-25°C to 105°C)

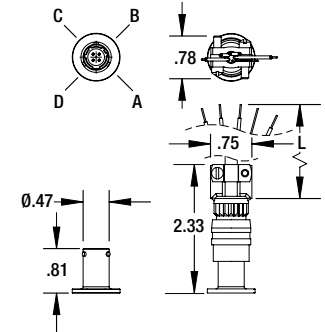

**Hirschmann EN 175301-803 Form C**

Code: DC  
IP66 (NEMA 4X)  
-40°F to 185°F (-40°C to 85°C)

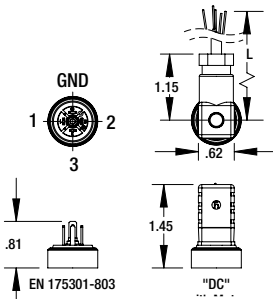

**M20 Conduit With Cable**

Code: MC, MV\*  
IP67 (NEMA 4X)  
-40°F to 257°F (-40°C to 125°C)

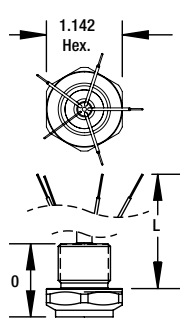

**1/2" NPT Conduit With Cable**

Code: CC, CV\*  
IP67 (NEMA 4X)  
-40°F to 257°F (-40°C to 125°C)

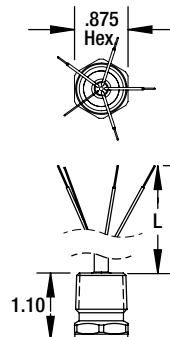

**1/2" NPT Conduit With Flying Leads**

Code: CF  
IP67 (NEMA 4X)  
-40°F to 257°F (-40°C to 125°C)

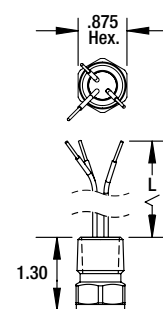

**M20 Conduit With Flying Leads**

Code: MF  
IP67 (NEMA 4X)  
-40°F to 257°F (-40°C to 125°C)

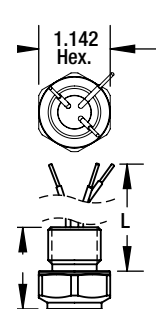

Note: \* Indicates Vented Cable

# Data Sheet

## E2G Pressure Transducer

**TABLE 5 - PRESSURE RANGES**

Vac.	PSI	bar	inHg
	VAC#	VACBR	VACIM
Compound	V&15#	V&1BR	V&30IM
	—	V&1.6BR	—
	V&30#	V&2BR	V&60IM
	V&45#	—	V&100IM
	V&60#	V&4BR	—
	—	V&6BR	—
	V&100#	—	V&200IM
	V&150#	—	—
	V&200#	—	—
	V&300#	—	—
Positive Pressure (psig)	1.5#	105MB	3IM
	5#	400MB	10IM
	—	600MB	—
	10#	—	20IM
	15#	1BR	30IM
	—	1.6BR	50IM
	30#	2BR	—
	—	2.5BR	—
	45#	—	—
	50#	—	100IM
	60#	4BR	—
	75#	—	—
	—	6BR	—
	100#	—	200IM
	150#	10BR	300IM
	200#	—	—
	—	16BR	—
	250#	—	500IM
	300#	20BR	—
	—	25BR	—
	500#	—	1000IM
	—	40BR	—
	750#	—	—
	—	60BR	—
	1000#	—	—
1500#	100BR	—	
2000#	160BR	—	
—	200BR	—	
2500#	—	—	
3000#	—	—	
—	250BR	—	
5000#	—	—	
—	400BR	—	
7500#	—	—	
—	600BR	—	
10000#	—	—	
15000#	1000BR	—	
20000#	—	—	
Absolute Pressure (psia)	15#A	1BRA	30IMA
	—	1.6BRA	50IMA
	30#A	2BRA	—
	—	2.5BRA	—
	50#A	—	100IMA
	—	4BRA	—
	—	6BRA	—
	100#A	—	200IMA
	—	10BRA	300IMA
	200#A	—	—
—	16BRA	500IMA	
—	20BRA	—	
500#A	—	—	

### DIMENSIONS

For reference only, consult Ashcroft for specific dimensional drawings

