



# Operation and Service Manual

---

## HypotULTRA<sup>®</sup> Series

Models 7800, 7804, 7820, 7850 and 7854

### Electrical Safety Compliance Analyzer

AC/DC Hipot, Insulation Resistance, Continuity and Ground Bond Test Instruments

*USB/RS-232 Interface standard on all models*

---

Serial \_\_\_\_\_

Item 39658 • Version 2.12

July 2024



\*Select models only.  
See specs for details.

# DECLARATION OF CONFORMITY



**Manufacturer:** Associated Research  
An Ikonix Brand

**Address:** 28105 North Keith Drive,  
Lake Forest, IL, 60045 USA

**Product Name:** HypotULTRA® Electrical Safety Compliance Analyzer

**Model Number:** 7800/7820/7850

## Conforms to the following Standards:

**Safety:** IEC 61010-2-030 :2010, IEC 61010-031 :2002+A1 :2008/EN 61010-031 :2002+A1 :2008  
UL 61010-1:2012, UL 61010-2-030:2012, CAN/CSA-C22.2 NO. 61010-1-12  
CAN/CSA-C22.2 NO. 61010-2-030-12, EN 61010-1:2010+A1:2019  
IEC 61010-1:2010+A1:2019, BS EN 61010-1:2010+A1:2019, EN 61010-2-030:2010  
BS EN 61010-2-030: 2010, IEC 61010-2-034: 2017, EN IEC 61010-2-034: 2021+A11  
BS EN IEC 61010-2-034:2021+A11, BS EN 61010-031:2002+A1:2008

**EMC:** EN 61326-1:2013/ BS EN 61326-1:2013 Class A  
EN 61000-3-3:2013/ IEC 61000-3-3:2013/ BS EN 61000-3-3:2013  
EN 61326-1:2013/BS EN 61326-1:2013 (Industrial Locations)  
EN 61000-4-2: 2009/ IEC 61000-4-2:2008/ BS EN 61000-4-2: 2009  
EN 61000-4-3: 2006+A1:2008+A2:2010  
IEC 61000-4-3:2006 +A1:2007+A2:2010  
BS EN 61000-4-3: 2006+A1:2008+A2:2010  
EN 61000-4-4: 2012/ IEC 61000-4-4:2012/ BS EN 61000-4-4: 2012  
EN 61000-4-5: 2014/ IEC 61000-4-5:2014/ BS EN 61000-4-5: 2014  
EN 61000-4-6: 2014/ IEC 61000-4-6:2013/ BS EN 61000-4-6: 2014  
EN 61000-4-8: 2010/ IEC 61000-4-8:2009/ BS EN 61000-4-8: 2010  
EN 61000-4-11: 2004/ IEC 61000-4-11:2004/BS EN 61000-4-11: 2004

## Supplementary Information

The product herewith complies with the requirements of the **Low Voltage Directive 2014/35/EU** and the **EMC Directive 2014/30/EU** and the **RoHS Directive 2015/863/EU** with respect to the following substances: Lead (Pb), Mercury (Hg), Cadmium (Cd), Hexavalent chromium (Cr (VI)), Polybrominated biphenyls (PBB), Polybrominated diphenyl ethers (PBDE), Bis phthalate (DEHP), Dibutyl phthalate (DBP), Benzyl butyl phthalate (BBP), Diisobutyl phthalate (DIBP), Deca-BDE included.

**Last two digits of the year in which the CE marking was affixed: 14**

The technical file and other documentation are on file with Associated Research

Adam Braverman  
President  
Ikonix  
Lake Forest, Illinois USA  
December 2022

# DECLARATION OF CONFORMITY



**Manufacturer:** Associated Research  
An Ikonix Brand

**Address:** 28105 North Keith Drive,  
Lake Forest, IL, 60045 USA

**Product Name:** HypotULTRA® Electrical Safety Compliance Analyzer

**Model Number:** 7804/7854

## Conforms to the following Standards:

**Safety:** IEC 61010-2-030 :2010, IEC 61010-031 :2002+A1 :2008/EN 61010-031 :2002+A1 :2008  
UL 61010-1:2012, UL 61010-2-030:2012, CAN/CSA-C22.2 NO. 61010-1-12  
CAN/CSA-C22.2 NO. 61010-2-030-12, EN 61010-1:2010+A1:2019  
IEC 61010-1:2010+A1:2019, BS EN 61010-1:2010+A1:2019  
EN 61010-2-030:2010, BS EN 61010-2-030: 2010, IEC 61010-2-034: 2017  
EN IEC 61010-2-034: 2021+A11, BS EN IEC 61010-2-034:2021+A11  
BS EN 61010-031:2002+A1:2008

**EMC:** EN 61326-1:2013/ BS EN 61326-1:2013 Class A,  
EN 61000-3-3:2013/ IEC 61000-3-3:2013/ BS EN 61000-3-3:2013  
EN 61326-1:2013/BS EN 61326-1:2013 (Industrial Locations)  
EN 61000-4-2: 2009/ IEC 61000-4-2:2008/ BS EN 61000-4-2: 2009  
EN 61000-4-3: 2006+A1:2008+A2:2010, IEC 61000-4-3:2006 +A1:2007+A2:2010  
BS EN 61000-4-3: 2006+A1:2008+A2:2010  
EN 61000-4-4: 2012/ IEC 61000-4-4:2012/ BS EN 61000-4-4: 2012  
EN 61000-4-5: 2014/ IEC 61000-4-5:2014/ BS EN 61000-4-5: 2014  
EN 61000-4-6: 2014/ IEC 61000-4-6:2013/ BS EN 61000-4-6: 2014  
EN 61000-4-8: 2010/ IEC 61000-4-8:2009/ BS EN 61000-4-8: 2010  
EN 61000-4-11: 2004/ IEC 61000-4-11:2004/BS EN 61000-4-11: 2004

## Supplementary Information

The product herewith complies with the requirements of the **Low Voltage Directive 2014/35/EU** and the **EMC Directive 2014/30/EU** and the **RoHS Directive 2015/863/EU** with respect to the following substances: Lead (Pb), Mercury (Hg), Cadmium (Cd), Hexavalent chromium (Cr (VI)), Polybrominated biphenyls (PBB), Polybrominated diphenyl ethers (PBDE), Bis phthalate (DEHP), Dibutyl phthalate (DBP), Benzyl butyl phthalate (BBP), Diisobutyl phthalate (DIBP), Deca-BDE included.

**Last two digits of the year in which the CE marking was affixed: 14**

The technical file and other documentation are on file with Associated Research

Adam Braverman  
President  
Ikonix  
Lake Forest, Illinois USA  
December 2022

# Warranty Policy

Ikonix, certifies that the tester listed in this manual meets or exceeds published manufacturing specifications. This tester was calibrated using standards that are traceable to the National Institute of Standards and Technology (NIST).

Your new tester is warranted to be free from defects in workmanship and material for a period of (5) years from date of shipment. We aim to provide an amazing experience and quality testers that last a long time. If you're not satisfied with your tester, return it within 45 days for a full refund. Calibrate annually with us, or one of our authorized partners, and we'll extend your warranty an additional year for the service life of your tester, and at least five years after discontinuation. If it breaks during that time, we promise to fix it for free (unless abuse or excessive damage is present). When your tester reaches the end of its service life, we'll responsibly recycle it and give you a discount on a replacement. Annual calibration and inspection must be made in each successive year starting one year after the original purchase date in order to remain eligible for extended warranty coverage beyond the standard warranty period (five years).

Ikonix recommends that your tester be calibrated on a twelve-month cycle. A return material authorization (RMA) must be obtained from Ikonix. To obtain an RMA please contact our Customer Support team at 1-847-367-4077 or visit [arisafety.com](http://arisafety.com). Damages sustained as a result of improper packaging will not be honored. Transportation costs for the return of the tester for warranty service must be prepaid by the customer. Ikonix will assume the return freight costs when returning the tester to the customer. The return method will be at the discretion of Ikonix.

Except as provided, herein Ikonix makes no warranties to the purchaser of this tester and all other warranties, expressed or implied (including, without limitation, merchantability or fitness for a particular purpose), are hereby excluded, disclaimed and waived.

Any non-authorized modifications, tampering or physical damage will void your warranty. Elimination of any connections in the earth grounding system or bypassing any safety systems will void this warranty. This warranty does not cover accessories not of Ikonix manufacture. Parts used must be parts that are recommended by Ikonix as an acceptable specified part. Use of non-authorized parts in the repair of this tester will void the warranty.

\*5 year warranty is valid on any model purchased in 2021 or after.

## Operator Modifications

Any non-authorized modifications, tampering or physical damage will void this warranty. Elimination of any connections in the earth grounding system or bypassing any safety systems will void this warranty. This warranty does not cover accessories not of Associated Research manufacture. Parts used must be parts that are recommended by Associated Research as an acceptable specified part. Use of non-authorized parts in the repair of this instrument will void the warranty.

Associated Research will not be responsible for any injuries sustained due to unauthorized equipment modifications or use of parts not specified by Associated Research Instruments returned to Associated Research with unsafe modifications will be returned to their original operating condition at your expense.

# Table of Contents

<a href="#">Safety Precautions and Warning Symbols for High Voltage Testing</a>	6
<a href="#">Front Panel Controls (7800, 7820 and 7850)</a>	7
<a href="#">Rear Panel Controls (7800, 7820 and 7850)</a>	8
<a href="#">Front Panel Controls (7804 and 7854)</a>	9
<a href="#">Rear Panel Controls (7804 and 7854)</a>	11
<a href="#">Setup Instructions</a>	13
<a href="#">Getting to Know Your Instrument</a>	14
<a href="#">Main Menu</a>	16
<a href="#">1. Setup System</a>	17
<a href="#">2. Setup Tests</a>	37
<a href="#">2.1 Setup Continuity Test</a>	38
<a href="#">2.2 Setup Ground Bond Test (7804 and 7854)</a>	39
<a href="#">2.3 Setup AC Withstand Test</a>	41
<a href="#">2.4 Setup DC Withstand Test</a>	43
<a href="#">2.5 Setup Insulation Resistance Test</a>	45
<a href="#">3. Perform Test</a>	55
<a href="#">4. Security</a>	65
<a href="#">5. FailCHEK</a>	67
<a href="#">6. MyMenu</a>	70
<a href="#">Using Remote I/O and PLC Control</a>	71
<a href="#">Appendix A - Installation and Test Operator Information</a>	74
<a href="#">Installation</a>	74
<a href="#">1. Unpacking and Inspection</a>	74
<a href="#">2. Safe Lifting and Carrying Instructions</a>	74
<a href="#">3. Contents of the Carton</a>	74
<a href="#">4. Preparation for Use</a>	75
<a href="#">5. Power Cable</a>	75
<a href="#">Operating Environment</a>	76
<a href="#">Storage and Shipment</a>	76
<a href="#">Test Operator and Safety Considerations</a>	76
<a href="#">1. Qualifications</a>	76
<a href="#">2. Safety Procedures</a>	77
<a href="#">3. Dress</a>	77
<a href="#">4. Medical Restrictions</a>	77
<a href="#">5. Test Station</a>	77
<a href="#">Appendix B - Instrument Specifications</a>	79
<a href="#">Appendix C - Options</a>	87
<a href="#">Appendix D - Remote Bus Interface</a>	108
<a href="#">Appendix E - Replacement Parts List</a>	127
<a href="#">Appendix F - Calibration Procedure</a>	129

NOTE: This is an interactive PDF, if viewing on a computer click on our [quick links](#) to jump quickly to that section. Return to the Table of Contents by simply clicking on the page number with a ▲ above it in the bottom right corner.

# Safety Precautions and Warning Symbols for High Voltage Testing

**GENERAL:** Review this product and its related documentation for familiarization with safety markings and instructions before operation.

This product is a Safety Class I instrument (provided with a protective earth terminal). Before applying power verify that the input voltage to the instrument is 115VAC±10% or 230VAC±10% and the correct fuse is installed.



Product will be marked with this symbol when it is necessary to refer to the operation and service manual in order to prevent injury or equipment damage.

S'il vous plaît se référer au manuel d'instructions de mise en garde ou information sur la prudence pour éviter des blessures ou des dommages au produit.



Product will be marked with this symbol when hazardous voltages may be present.

Avertissement des tensions dangereuses qui peuvent être présentes.



Product will be marked with this symbol at connections that require earth grounding.

Le produit sera marqué de ce symbole au niveau des connexions qui nécessitent à la terre.

## Caution and Warning Symbols

### WARNING

Calls attention to a procedure, practice, or condition that could possibly cause bodily injury or death.

Appelle l'attention sur une procédure, une pratique ou une condition qui pourrait causer des blessures corporelles ou la mort.

### CAUTION

Calls attention to a procedure, practice, or condition that could possibly cause damage to equipment or permanent loss of data.

Appelle l'attention sur une procédure, une pratique ou une condition qui pourrait causer des blessures corporelles ou la mort.

### WARNING

The HypotULTRA produces voltages and currents that can cause **harmful or fatal electric shock**. To prevent accidental injury or death, these safety procedures must be strictly observed when handling and using the test instrument.

Le HypotULTRA, des tensions et des courants qui peuvent causer des chocs électriques dangereux ou mortel. Pour éviter toute blessure ou un décès accidentels, ces procédures de sécurité doivent être strictement respectées lors de la manipulation et l'utilisation de l'appareil de contrôle.

# Front Panel Controls (7800, 7820 and 7850)

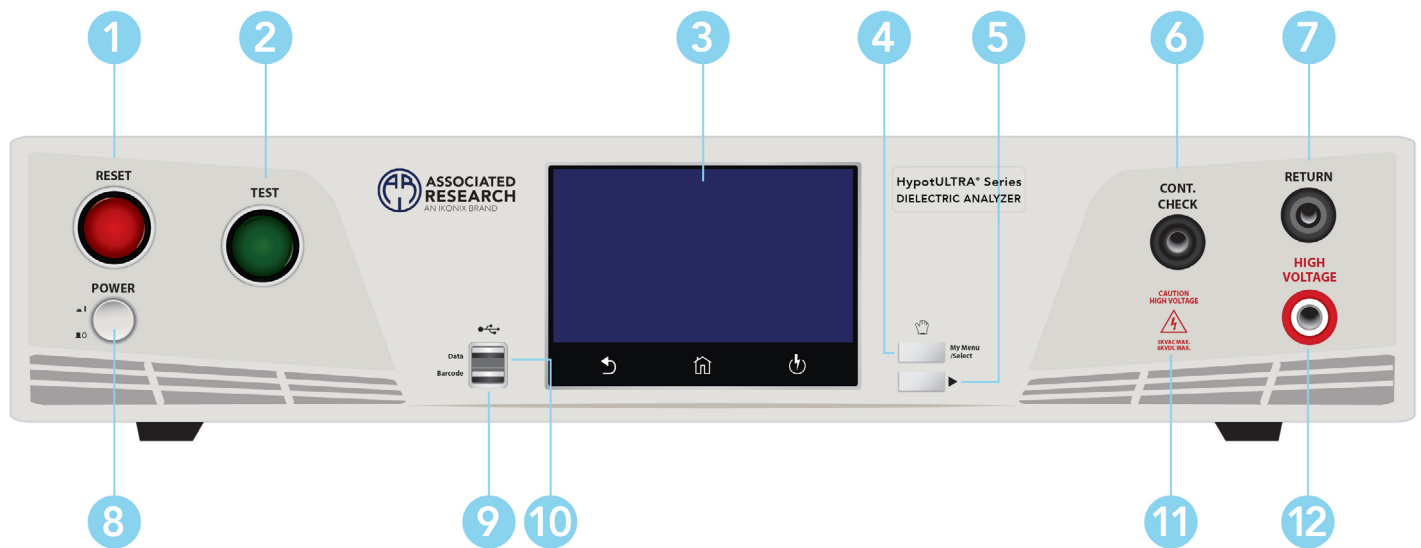

- 1 RESET BUTTON** - Resets the instrument. If a failure condition occurs during a test, pressing this button will reset the system, shut off the alarm and clear the failure condition. You must press the Reset button before performing another test or changing any of the setup parameters. This button also serves as an abort signal to stop any test in progress.
- 2 TEST BUTTON** - This is a momentary contact switch used to start a test. Press the green button to turn on the high voltage output when in test mode. The indicator lamp within the button will light when test expires with pass condition.
- 3 TOUCH SCREEN GRAPHIC LCD** - Displays all the information and allows full control of the instrument.
- 4 MY MENU** - Brings up the MyMENU screen.
- 5 TOGGLE** - This button allows you to toggle between test files if you are wearing high voltage gloves.
- 6 CONTINUITY OUTPUT TERMINAL** - Connector used to attach the return test lead, adaptor box return lead, or test fixture return lead used during Continuity testing.
- 7 RETURN TERMINAL** - Connector used to attach the return test lead, adapter box return lead or test fixture return lead to the instrument. This connection provides the return current path.
- 8 POWER SWITCH** - Powers the test instrument ON or OFF.
- 9 BARCODE USB PORT** - This USB style port allows for connecting a barcode scanner.
- 10 DATA USB PORT** - This USB style port allows for connecting a USB flash drive to extract test and system data.
- 11 HIGH VOLTAGE INDICATOR** - This indicator flashes to warn the operator that high voltage is present at the high voltage output terminal.
- 12 HIGH VOLTAGE OUTPUT TERMINAL** - Connector used to attach the high voltage test lead, adapter box high voltage lead or test fixture high voltage lead to the instrument. This connection provides the high voltage used during a Hipot test.

# Rear Panel Controls (7800, 7820 and 7850)

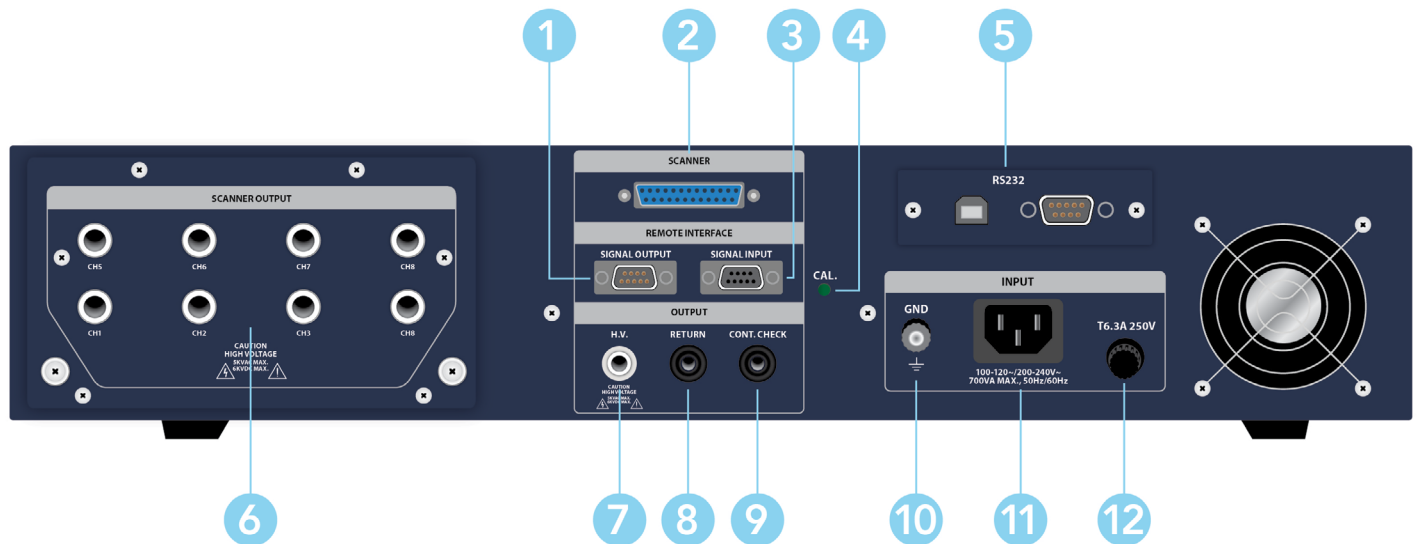

- 1 REMOTE SIGNAL OUTPUT** - 9-Pin D-type subminiature female connector for monitoring PASS, FAIL, and PROCESSING output relay signals.
- 2 SCANNER CONNECTOR** - For connection of optional external Scanner.
- 3 REMOTE SIGNAL INPUT** - 9-Pin D-type subminiature male connector for remote control of TEST, RESET, and REMOTE INTERLOCK DISABLE functions, as well as MEMORY SELECTION.
- 4 CALIBRATION BUTTON** - To put the instrument into the calibration mode push this button and turn on the power switch simultaneously.
- 5 BUS INTERFACE** - Standard connector for interconnection to the USB/RS-232 Bus interface. You can substitute an Optional IEEE 488 (GPIB) or Ethernet interface for the USB/RS-232.
- 6 SCANNER OUTPUTS** - Optional internal Scanner matrix that provides 8 HV/Continuity/Return connections. Please refer to the Options section of this manual for additional connection information.
- 7 REAR PANEL HIGH VOLTAGE OUTPUT TERMINAL** - 2nd high voltage output connector in parallel with the front panel connector.
- 8 REAR PANEL RETURN TERMINAL** - 2nd return output connector in parallel with the front panel connector.
- 9 REAR PANEL CONTINUITY OUTPUT TERMINAL** - 2nd continuity output connector in parallel with the front panel output.
- 10 CHASSIS GROUND (EARTH) CONNECTION** - Connect this terminal to a good earth ground before operation.
- 11 INPUT POWER RECEPTACLE** - Standard IEC 320 connector for connection to a standard NEMA style line power (mains) cord.
- 12 FUSE RECEPTACLE** - To change the fuse, unplug the power (mains) cord and turn the fuse receptacle counter-clockwise. This will expose the fuse compartment. Please replace the fuse with one of the proper rating.



# Front Panel Controls (7804 and 7854)

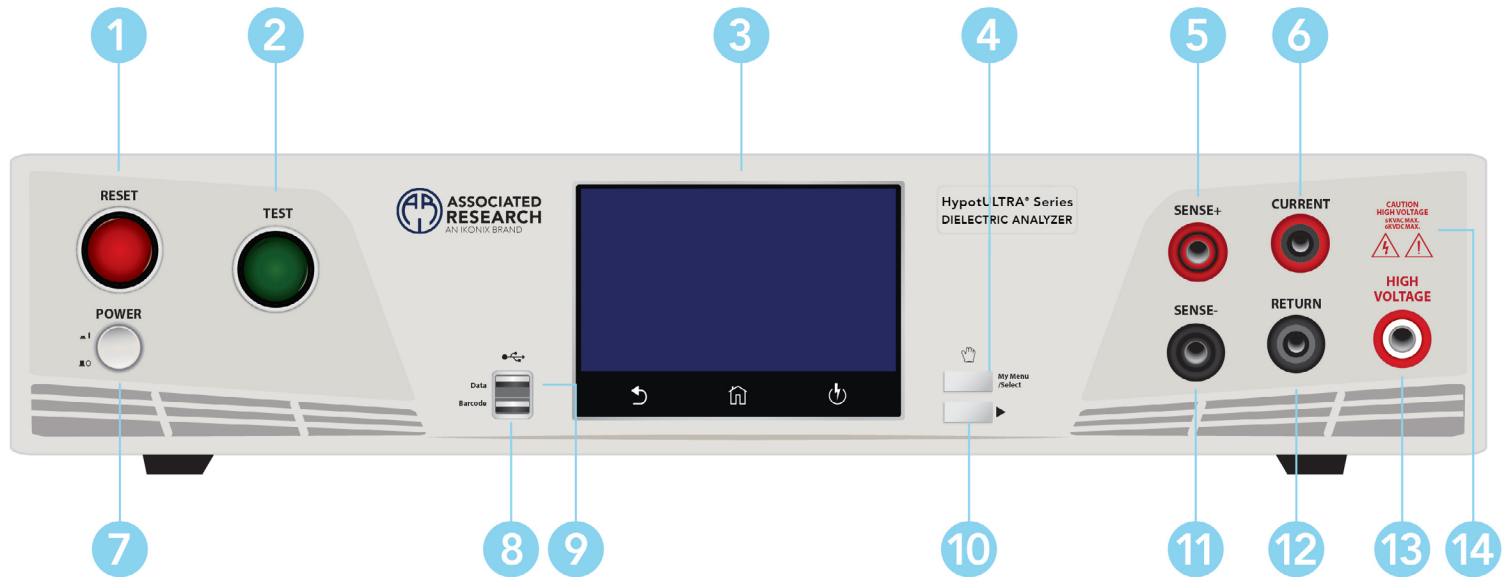

- 1 RESET BUTTON** - Resets the instrument. If a failure condition occurs during a test, pressing this button will reset the system, shut off the alarm and clear the failure condition. You must press the Reset button before performing another test or changing any of the setup parameters. This button also serves as an abort signal to stop any test in progress.
- 2 TEST BUTTON** - This is a momentary contact switch used to start a test. Press the green button to turn on the high voltage output when in test mode. The indicator lamp within the button will light when test expires with pass condition.
- 3 TOUCH SCREEN GRAPHIC LCD** - Displays all the information and allows full control of the instrument.
- 4 MY MENU** - Brings up the MyMENU screen.
- 5 SENSE+ TERMINAL** - Connector used to attach the + sense lead for 4-wire Kelvin current measurement. This connection provides for accurate current measurement during the Ground Bond test.
- 6 CURRENT OUTPUT TERMINAL** - Connector used to attach the high current output lead, adapter box high current lead or test fixture high current lead to the instrument. This connection provides the output current for the ground bond and continuity.
- 7 POWER SWITCH** - Powers the test instrument ON or OFF.
- 8 BARCODE USB PORT** - This USB style port allows for connecting a barcode scanner.
- 9 DATA USB PORT** - This USB style port allows for connecting a USB flash drive to extract test and system data.
- 10 TOGGLE** - This button allows you to toggle between test files if you are wearing high voltage gloves.

Continued on next page →

- 11 **SENSE- TERMINAL** - Connector used to attach the - sense lead for 4-wire Kelvin current measurement. This connection provides for accurate current measurement during the Ground Bond test.
- 12 **RETURN TERMINAL** - Connector used to attach the return test lead, adapter box return lead or test fixture return lead to the instrument. This connection provides the return current path.
- 13 **HIGH VOLTAGE OUTPUT TERMINAL** - Connector used to attach the high voltage test lead, adapter box high voltage lead or test fixture high voltage lead to the instrument. This connection provides the high voltage used during a Hipot test.
- 14 **HIGH VOLTAGE INDICATOR** - This indicator flashes to warn the operator that high voltage is present at the high voltage output terminal.

# Rear Panel Controls (7804 and 7854)

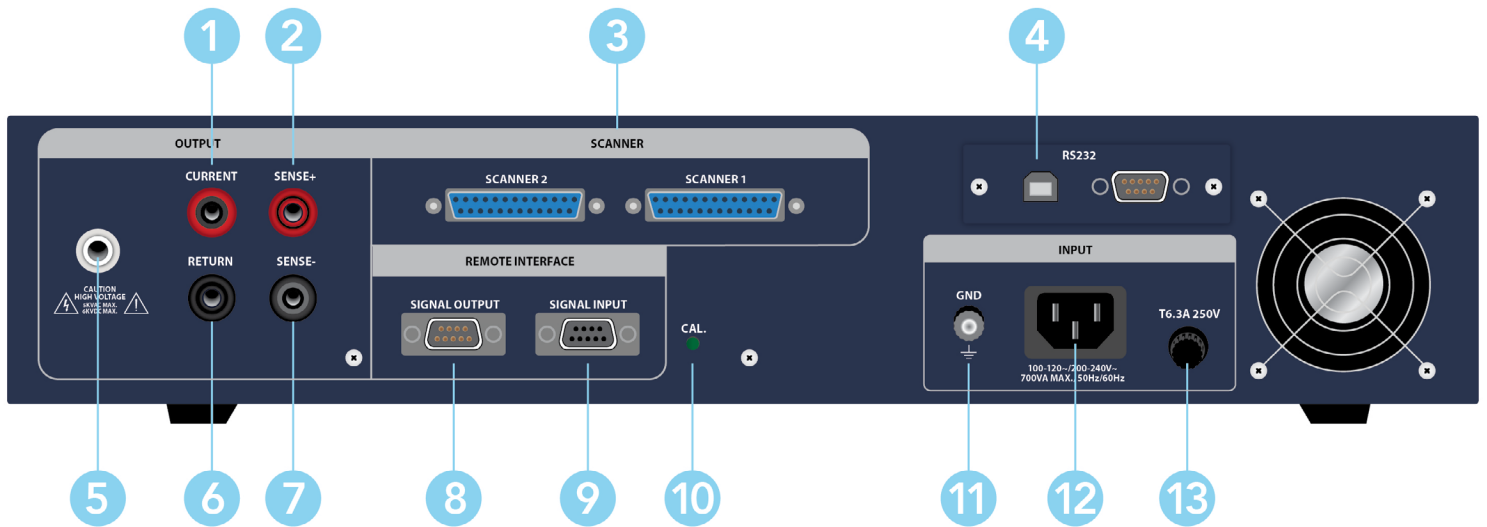

- 1 CURRENT OUTPUT TERMINAL** - Connector used to attach the high current output lead, adapter box high current lead or test fixture high current lead to the instrument. This connection provides the output current for the ground bond and continuity.
- 2 SENSE+ TERMINAL** - Connector used to attach the + sense lead for 4-wire Kelvin current measurement. This connection provides for accurate current measurement during the Ground Bond test.
- 3 SCANNER CONNECTOR** - For connection of optional external Scanner.
- 4 BUS INTERFACE** - Standard connector for interconnection to the USB/RS-232 Bus interface. You can substitute an Optional IEEE 488 (GPIB) or Ethernet interface for the USB/RS-232.
- 5 REAR PANEL HIGH VOLTAGE OUTPUT TERMINAL** - 2nd high voltage output connector in parallel with the front panel connector.
- 6 REAR PANEL RETURN TERMINAL** - 2nd return output connector in parallel with the front panel connector.
- 7 SENSE- TERMINAL** - Connector used to attach the - sense lead for 4-wire Kelvin current measurement. This connection provides for accurate current measurement during the Ground Bond test.
- 8 REMOTE SIGNAL OUTPUT** - 9-Pin D-type subminiature female connector for monitoring PASS, FAIL, and PROCESSING output relay signals.
- 9 REMOTE SIGNAL INPUT** - 9-Pin D-type subminiature male connector for remote control of TEST, RESET, and REMOTE INTERLOCK DISABLE functions, as well as MEMORY SELECTION.

Continued on next page →

- 10 **CALIBRATION BUTTON** - To put the instrument into the calibration mode push this button and turn on the power switch simultaneously.
- 11 **CHASSIS GROUND (EARTH) CONNECTION** - Connect this terminal to a good earth ground before operation.
- 12 **INPUT POWER RECEPTACLE** - Standard IEC 320 connector for connection to a standard NEMA style line power (mains) cord.
- 13 **FUSE RECEPTACLE** - To change the fuse, unplug the power (mains) cord and turn the fuse receptacle counter-clockwise. This will expose the fuse compartment. Please replace the fuse with one of the proper rating.

# Setup Instructions

## Power Up Sequence

1. Connect the power input plug into its socket on the rear panel of the instrument. Connect the male end of the plug to the outlet receptacle.

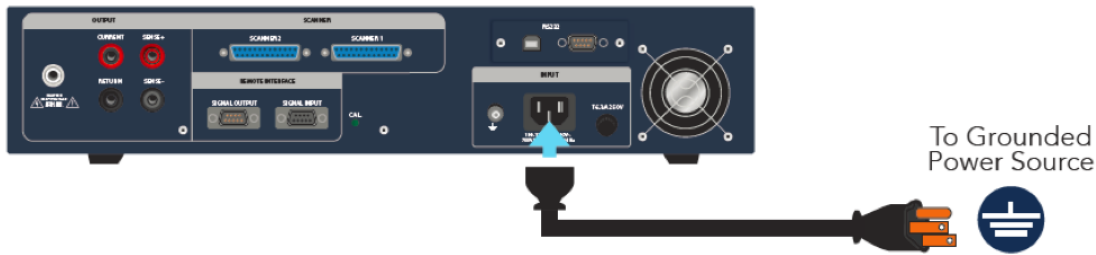

### WARNING

Only insert the main plug in a socket outlet with a protective ground (earth) contact. This protective ground must not be defeated by the use of an extension cord without a protective conductor.

La fiche principale ne doit être insérée dans une prise de courant avec une masse (terre) avec système de protection. Cette terre de protection ne doit pas être vaincu par l'utilisation d'une rallonge sans conducteur de protection.

2. Connect the Interlock Disable key to the Remote Input connector on the back panel of the instrument. This is required in order to run a test. For more information on the interlock, see section for Remote Interlock.

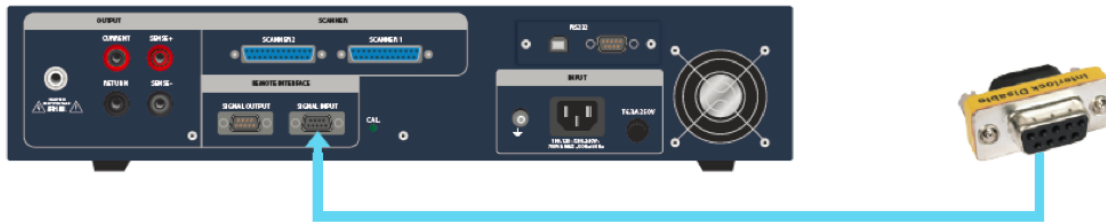

3. Turn on the POWER switch located on the lower left hand side of the front panel. Upon powering the instrument up, a POWER ON SELF TEST (POST) will automatically be performed. This test will check for the condition of the ram chips, PCB's and other critical components. The instrument screen will then default to the main menu.

The default screen is the main menu screen of the instrument. From this screen you can access all the functions and settings of the instrument:

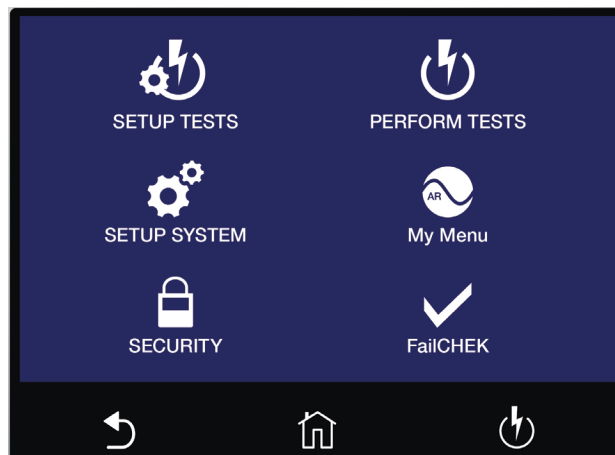

Main Menu

# Getting to Know Your Instrument

## Using the Touch Screen

The touch screen display of the HypotULTRA provides full control of the instrument. Use the touch screen to setup system and test parameters as well as security setup and calibration. HypotULTRA's touch screen functions just like any other touch screen.

## Soft Keys

The HypotULTRA touch screen has 3 functional keys: Back, Home and Perform Tests:

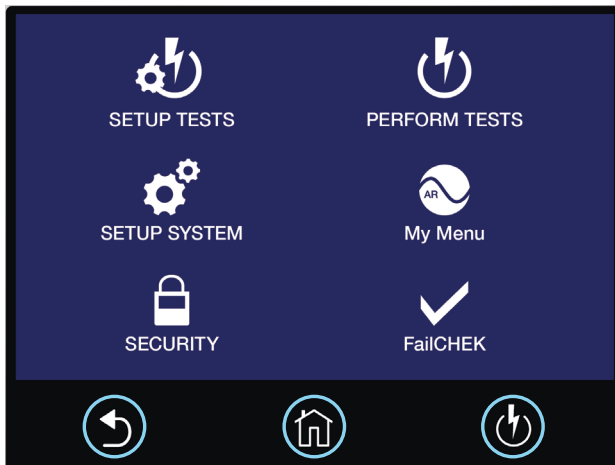

Use the **Back** key to return to a previous screen.



Use the **Home** key to return to the Main Menu.



Use the **Perform Tests** key to navigate to the Perform Tests screen.

## Touch

The various screens of the HypotULTRA will display icons and parameters. Touch the appropriate icon or parameter with the fingertip as shown in the image to the right.

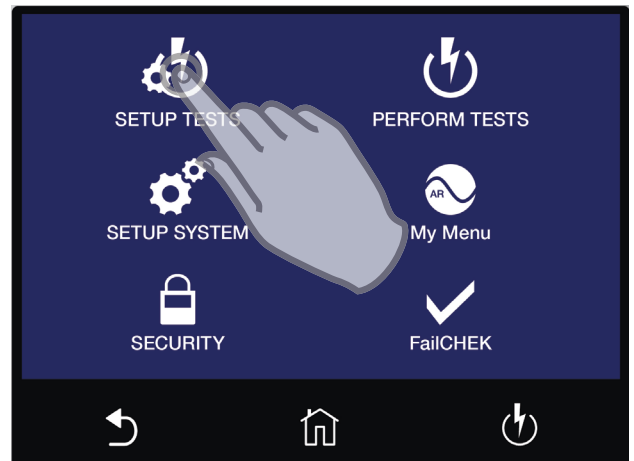

## Scroll and Swipe

A scroll bar on the right side of the screen indicates that there are additional parameters or features. To scroll up and down between parameters touch the screen anywhere scroll upward or downward. Swipe left to right in order to change parameters when setting up test or system values.

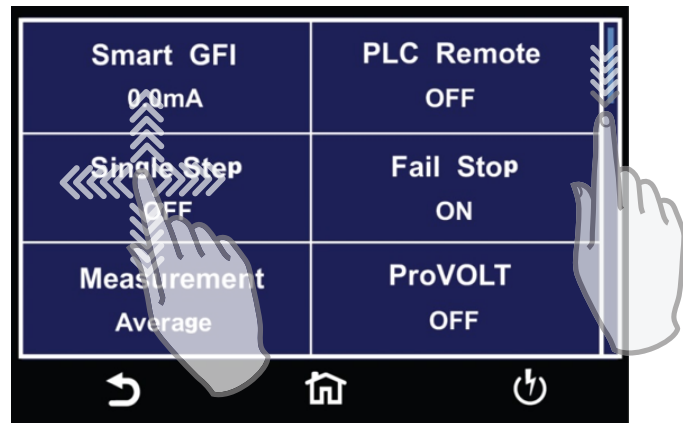

## Drag and Drop

You can drag and drop test files, steps and meters on certain HypotULTRA screens. To use this feature simply touch and hold the test file, test step or parameter. Drag the file to the appropriate location as shown in the following screen to the right.

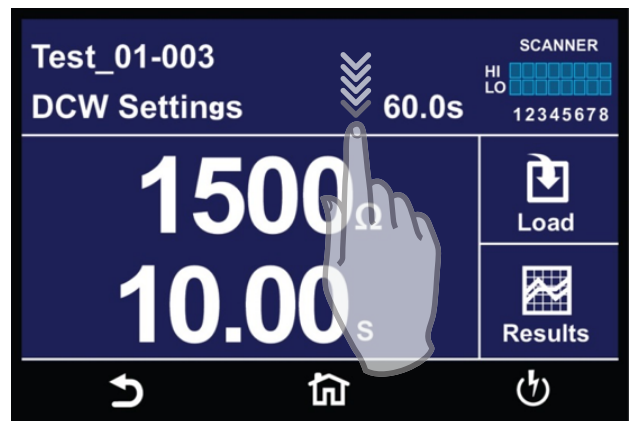

# Main Menu

Upon powering up, the instrument will default to the Main Menu. The Main Menu is also the default home screen.

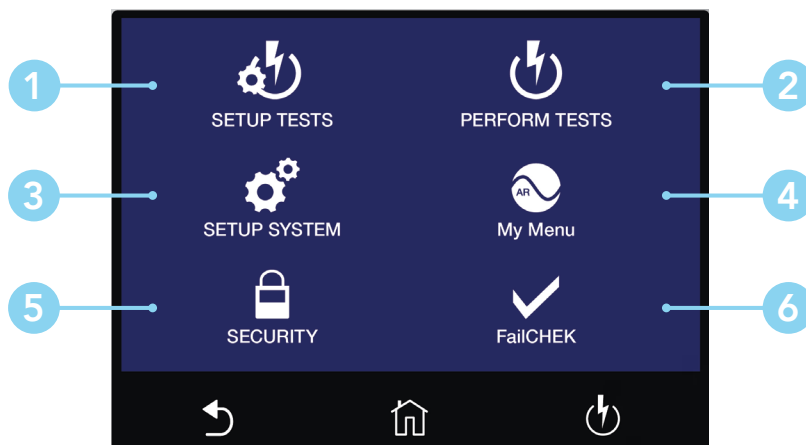

Main Menu

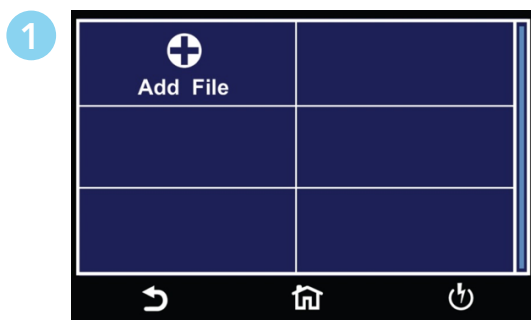

Setup Tests Screen - Create test files.

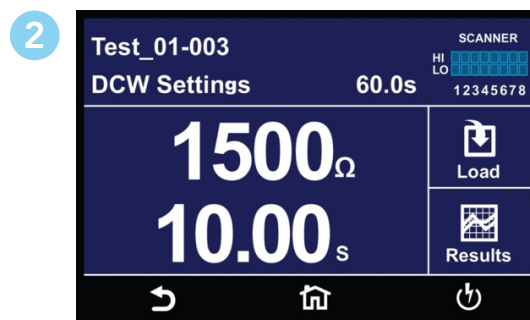

Perform Test Screen - Navigate to the Perform Tests screen in order to run a test sequence.

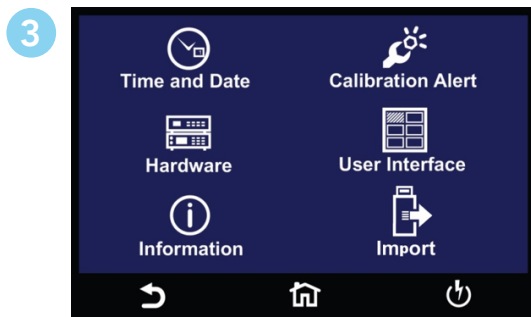

Setup System Menu - Instrument global parameters such as time and date, calibration and hardware.



My Menu Screen - User customized menu.

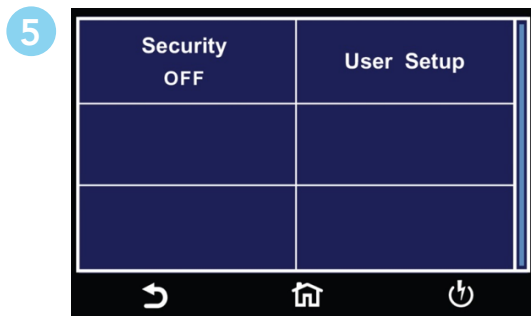

Security Menu - Access instrument lockout and security features.

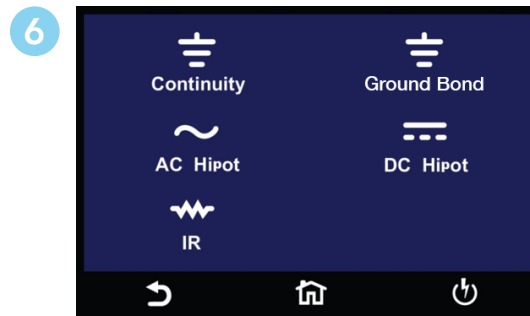

FailCHEK® Menu - Check the instrument's failure detectors.

**\*Note – Details of each system and test parameter are listed in the relevant sections of the manual.**



# 1. Setup System

From the default main menu touch the Setup System icon to enter the Setup System sub menu. This is where all System Parameters can be edited:

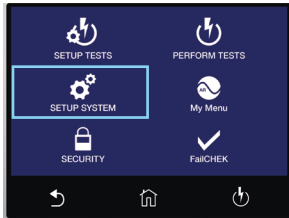

Main Menu



Setup System Menu



Time and Date Menu

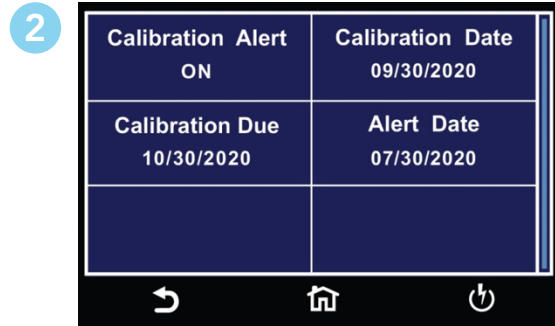

Calibration Alert Menu

Continued on next page →

## Setup System Continued

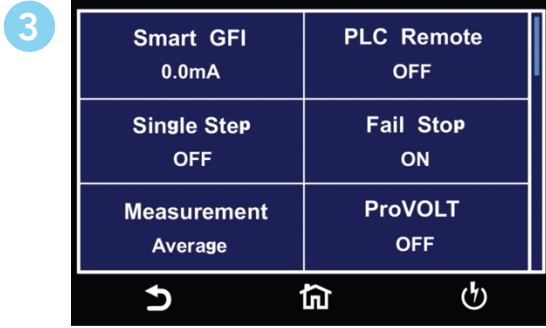

Hardware Menu

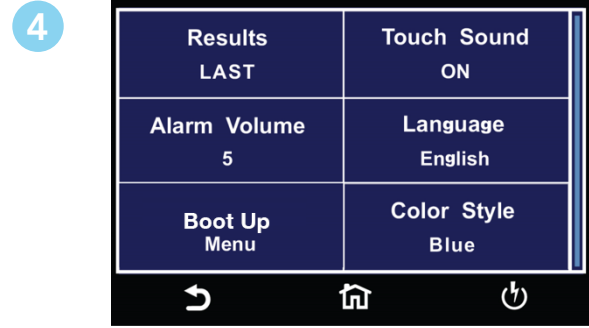

User Interface

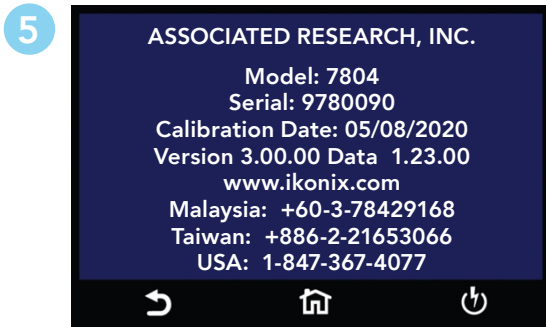

Information Screen



[Import/Export](#) Menu

## Time and Date

Time and Date menu allows the user to edit and save the System Time and Date. This time and date will be used to stamp the test results data.

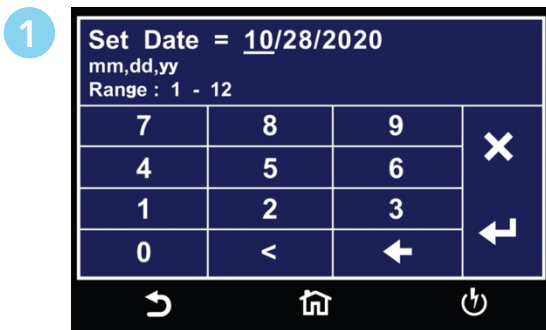
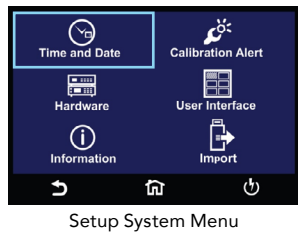

Enter the current date to set System Date.

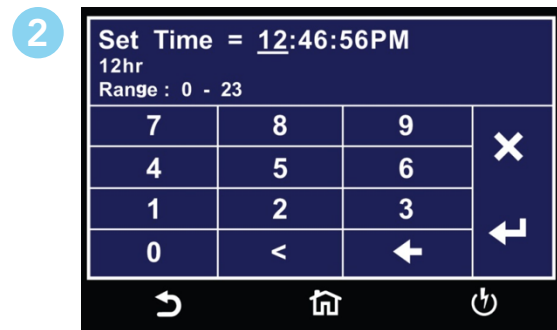

Enter current time to set System Time.

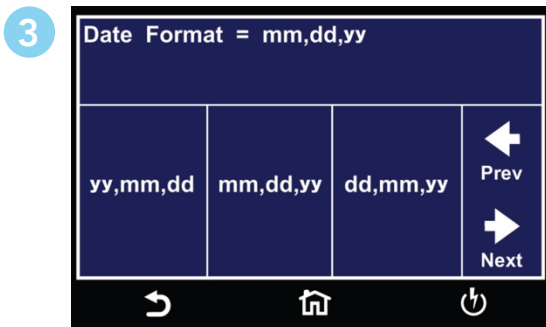

Select the Date Format for System Date.

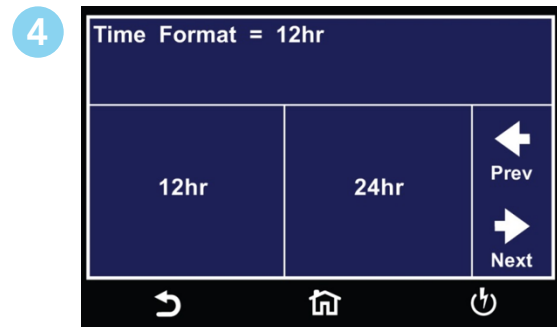

Select the Time Format for System Time.

## Calibration Alert

The Calibration Alert menu allows the user to setup alerts prior to the Calibration Due date. The user can also edit the Calibration Due date. It is not recommended that the Calibration Due date be changed once the instrument has been calibrated. Associated Research recommends annual calibrations for all models.

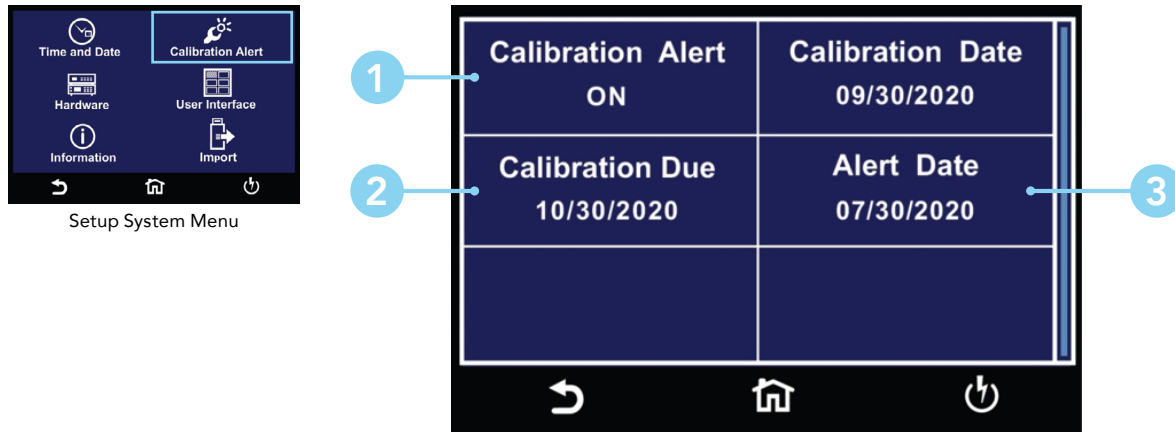

Calibration Alert Menu

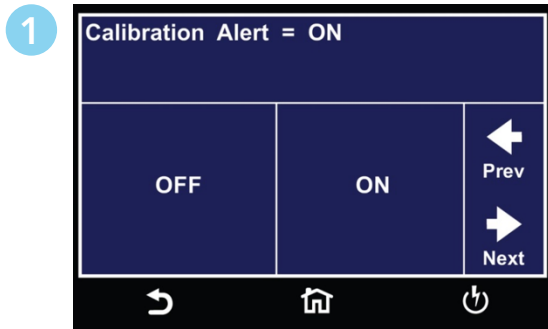

Select Calibration Alert ON or OFF.

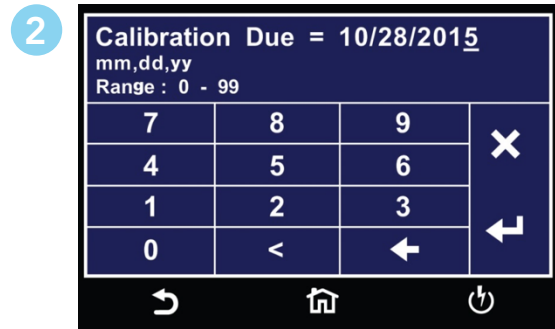

Enter a Calibration Due date.

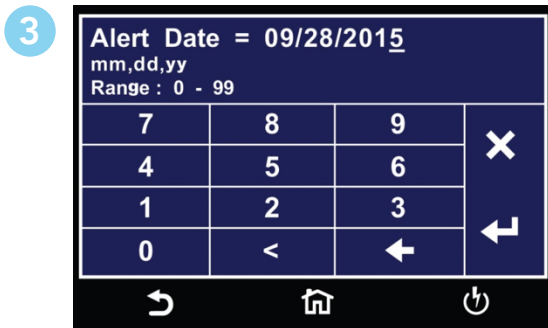

Enter a Calibration Alert Date.

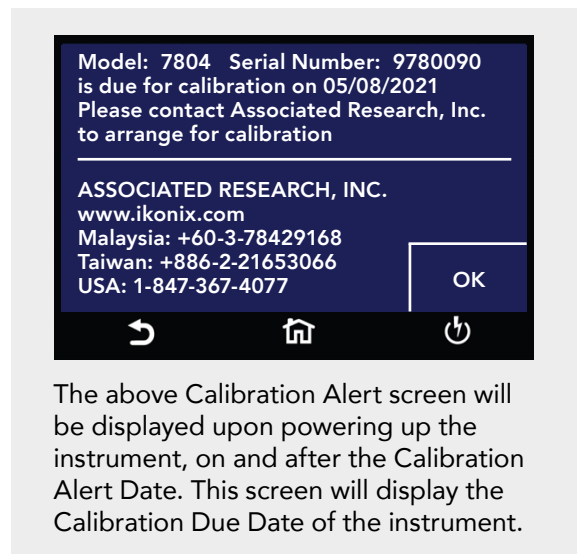

The above Calibration Alert screen will be displayed upon powering up the instrument, on and after the Calibration Alert Date. This screen will display the Calibration Due Date of the instrument.

## Information Screen

The Information screen displays all instrument information including: Model Number, Serial Number, Calibration Date, Company Information and Firmware Version.



## User Interface

The User Interface menu allows the user to edit Results, Touch Sound, Alarm Volume, Language, Home Screen, Color Style and Dual Test parameters.

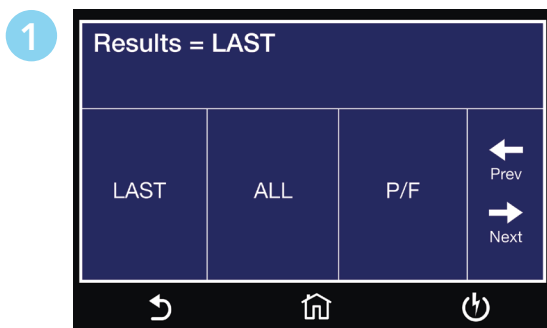
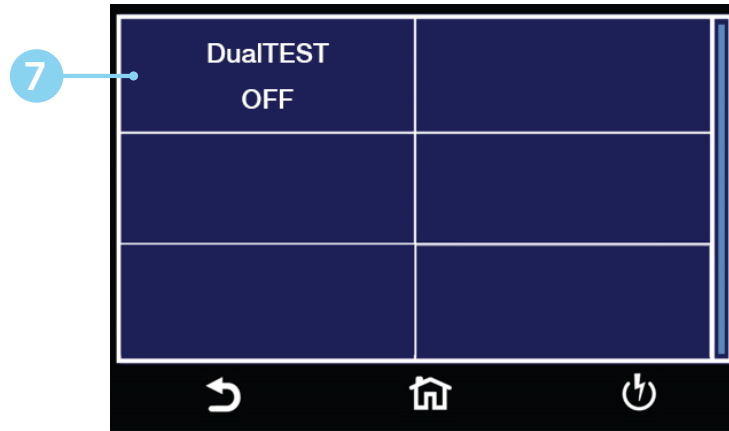
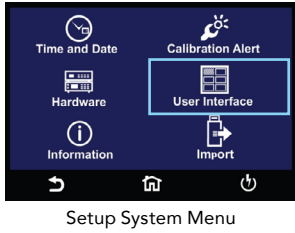

Select end of test [Result](#) Screen.

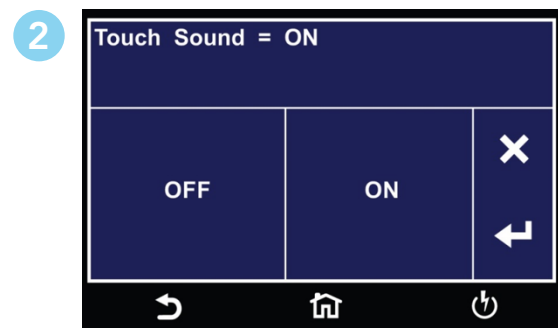

Select [Touch Sound](#) ON or OFF.

Continued on next page →

## User Interface Continued

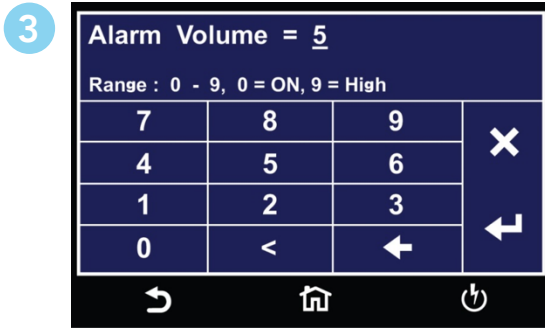

Enter Alarm [Volume level](#).



Select [System Language](#).

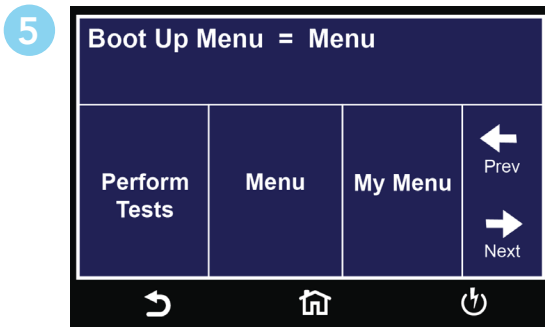

Select start up [Boot Up Menu](#).

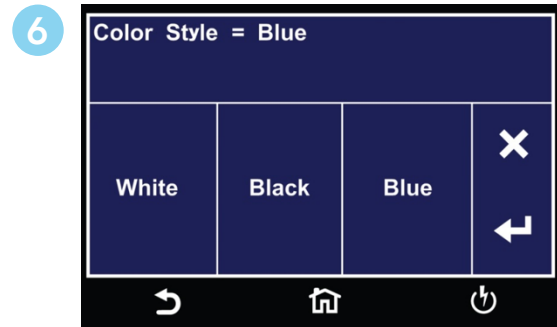

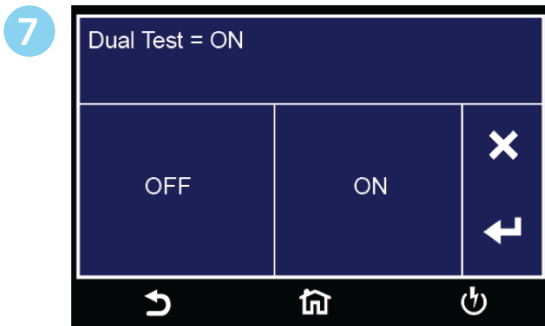

Select System [Color Style](#).



Select [Dual Test](#) ON or OFF for Dual Remote Palm Switches.

## User Interface Parameter Descriptions

Descriptions of User Interface parameters are listed in the following table:

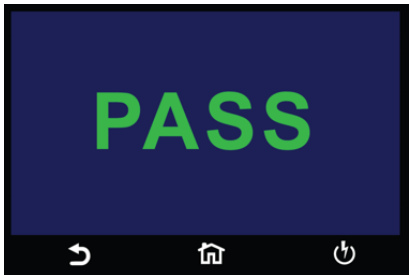
RESULT	Select how the test results will be displayed at the end of a test or test sequence.																
	<p>LAST</p> <p>The results of the last step performed will be displayed on the Perform Tests screen. There will not be a change in appearance or special screen displayed in this mode.</p>																
	<p>ALL</p> <p>Results summary screen will be displayed at the end of the test or sequence of connected steps displaying the results of all of the steps.</p>	 <table border="1" data-bbox="1024 573 1430 846"> <thead> <tr> <th>ACW</th> <th>Settings</th> <th>Results</th> </tr> </thead> <tbody> <tr> <td>Voltage:</td> <td>1000V</td> <td>1.00kV</td> </tr> <tr> <td>HI-LIMIT T:</td> <td>30.00mA</td> <td>0.005mA</td> </tr> <tr> <td>HI-LIMIT R:</td> <td>30.00mAR</td> <td>0.005mAR</td> </tr> <tr> <td>Time:</td> <td>50.0s</td> <td>23.1s</td> </tr> </tbody> </table>	ACW	Settings	Results	Voltage:	1000V	1.00kV	HI-LIMIT T:	30.00mA	0.005mA	HI-LIMIT R:	30.00mAR	0.005mAR	Time:	50.0s	23.1s
ACW	Settings	Results															
Voltage:	1000V	1.00kV															
HI-LIMIT T:	30.00mA	0.005mA															
HI-LIMIT R:	30.00mAR	0.005mAR															
Time:	50.0s	23.1s															
	<p>P/F</p> <p>Pass or Fail screen will be displayed at the end of the test.</p>																
<p>Touch Sound</p>	<p>Set the instrument to emit a short audible beep anytime the screen is touched. Select between ON or OFF.</p>																
<p>Alarm Volume</p>	<p>Set the instrument alarm volume. The numbers corresponding to the different volume settings are 0 through 9, 0 meaning the volume is off, and 9 being the loudest setting.</p>																
<p>Language</p>	<p>Set the instrument display in the desired language. The available languages on the HypotULTRA instruments are English, Chinese, Simplified Chinese, German, French, Turkish, Portuguese and Spanish.</p>																
<p>Home Screen</p>	<p>Set the default screen upon instrument power up. Choose between Perform Test, Menu or My Menu.</p>																
<p>Color Style</p>	<p>Set the color style of the touch screen.</p>																
<p>Dual Test</p>	<p>The Dual Remote Test Switch option allows you to configure dual palm switches for safe production line operation. Both PLC Remote and Dual Test must be ON in order for dual remote test switch operation below to work. The rear panel remote interface is reconfigured to allow two test switches instead of the standard reset and test inputs. The two test switches have to be pressed within 0.5 seconds to activate the test process. The two test switches must remain closed to continue the test. If either of the test switches is released, the process will be shut down immediately. The function of the Test switch on the front panel will be disabled if the dual test switches are enabled. When the Dual Test parameter is turned OFF, the Test and Reset switches on the front and rear panel behave the same as the standard instrument, and are controlled by the PLC Remote On/Off selection.</p>																



## Import/Export

Insert USB disk into Data port and the following screen will appear. Select Import/Export to use the Import/Export menu to transfer data. Select Result Data to go to Result Data settings menu. Please refer to the Results Data section of this manual.

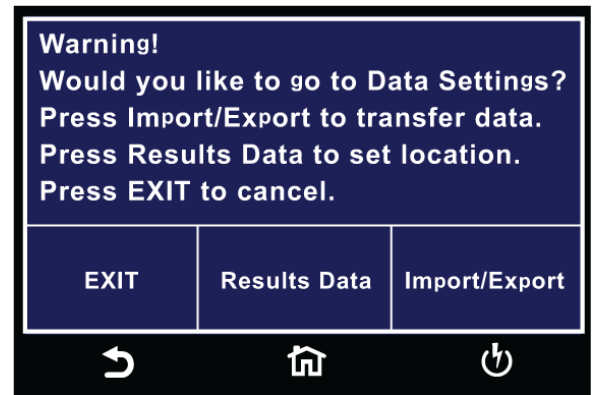

The Import/Export menu allows the user to import or export System and Test Files from a USB flash drive into the instrument memory. The Import/Export menu will only appear under the Hardware menu if a USB flash drive is inserted into the Data port on the front panel of the instrument.



Setup System Menu



Import/Export Menu



Import/Export Menu

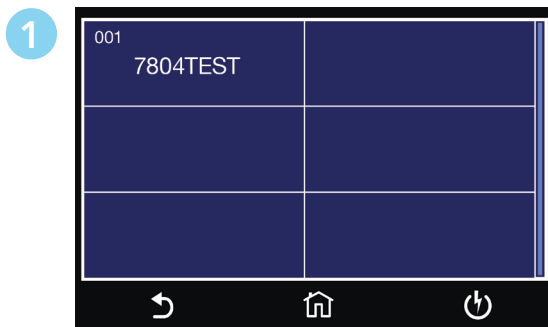

Select the Test File to export.

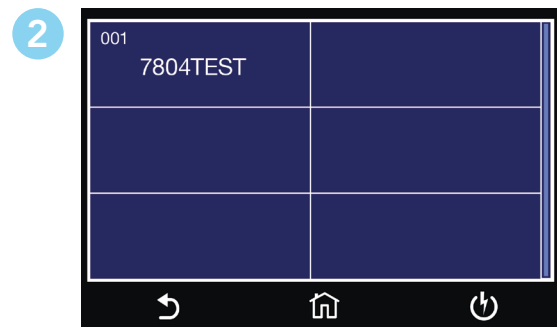

Import a single Test file.

Continued on next page →

## Import/Export Continued

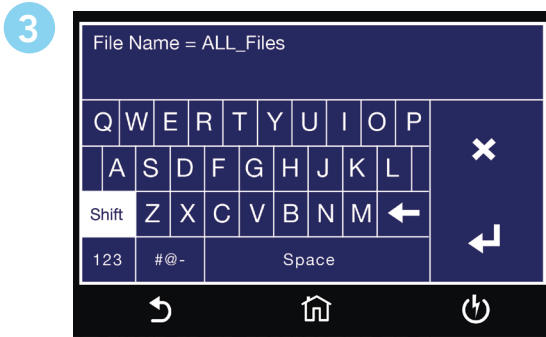

Enter file name for exporting All Files.

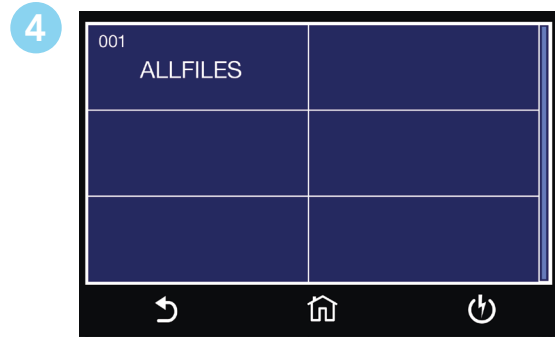

Import all Test files.

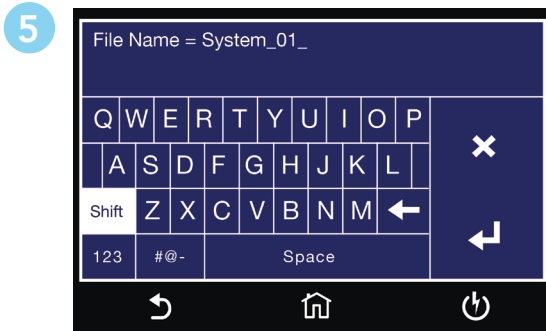

Enter file name for exporting System File.

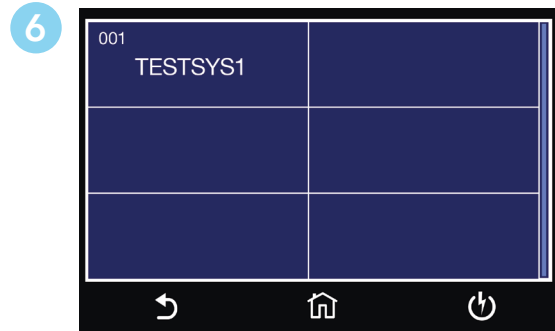

Import System file.

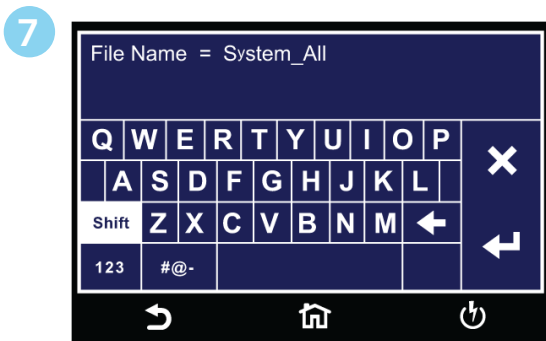

Enter file name for exporting System and All Files.

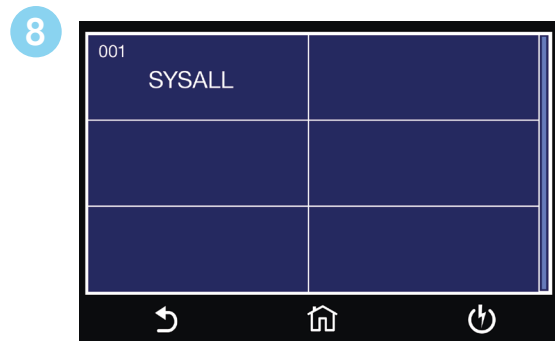

Import System and all Test files.

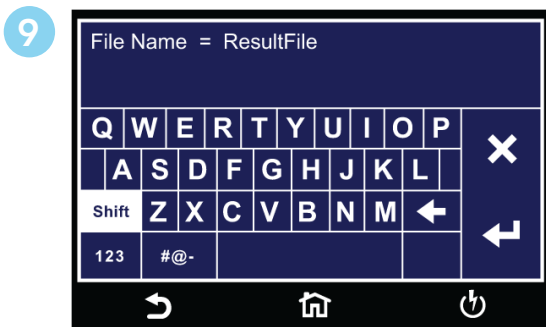

Enter file name for exporting results from internal memory.

With Result Setup Location set to Int. Memory, Transfer can be used to export result data stored on the internal memory. The number displayed shows total number of available results stored on internal memory.

# Hardware

The Hardware menu allows the user to setup hardware parameters.

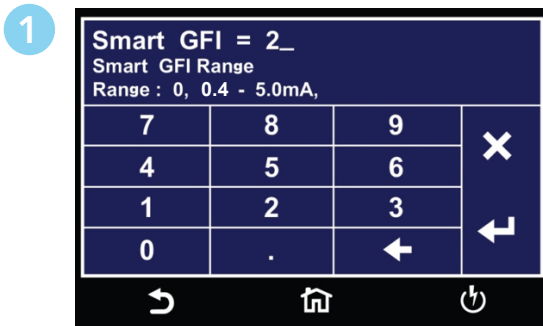
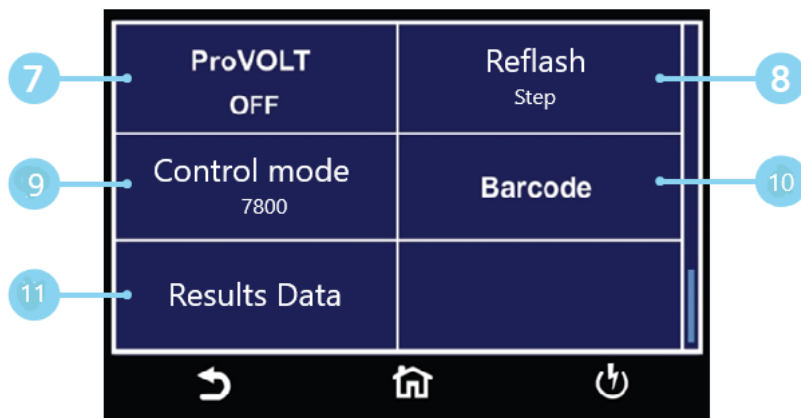
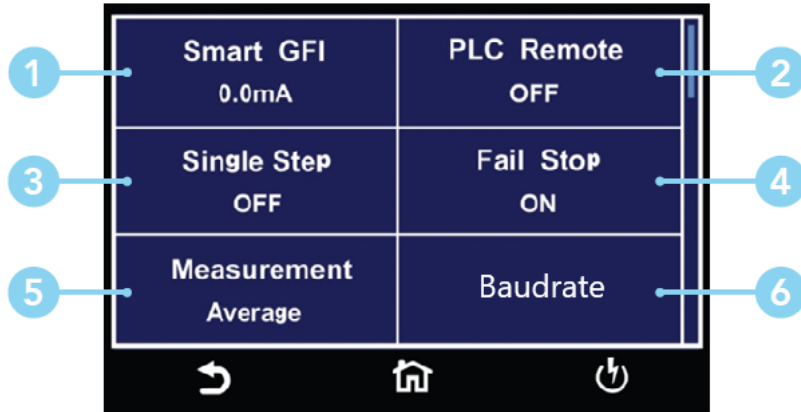
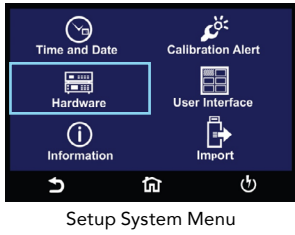

Enter **SmartGFI®** value.

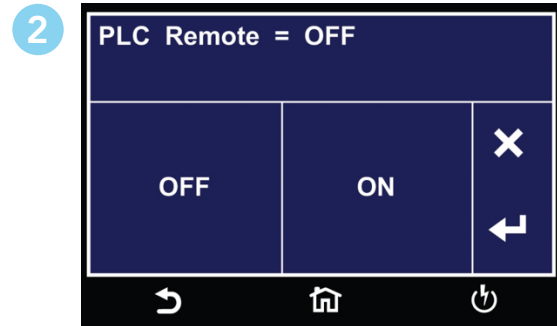

Select **PLC Remote** ON or OFF.

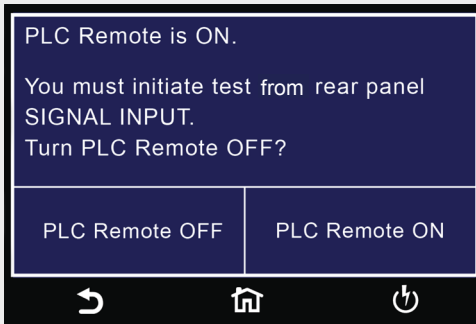

This screen comes up when pressing TEST button while PLC is ON warning customer to adjust PLC setting if need to use the TEST button.

Continued on next page →

## Hardware Continued

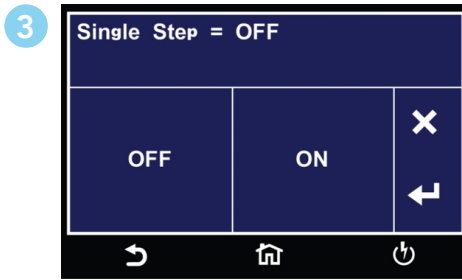

Select [Single Step](#) ON or OFF.

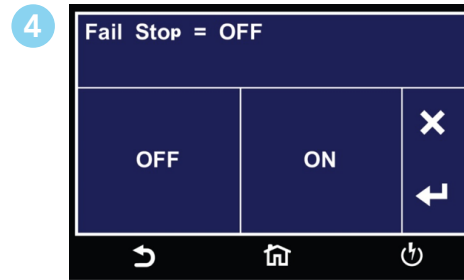

Select [Fail Stop](#) ON or OFF.

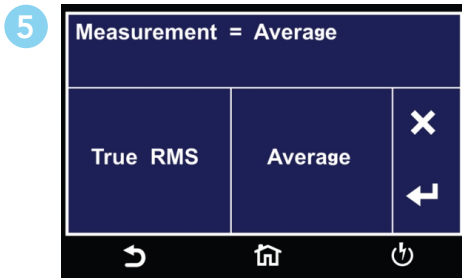

Select [Measurement](#).

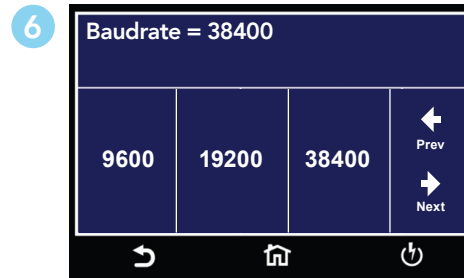

Select COM Port Baud Rate.

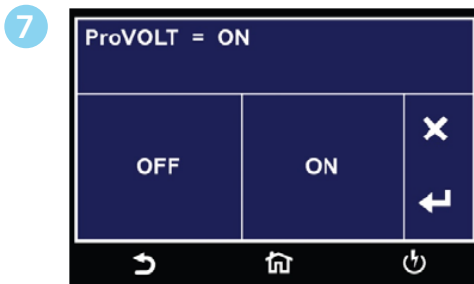

Select [Pro-VOLT](#)® ON or OFF.

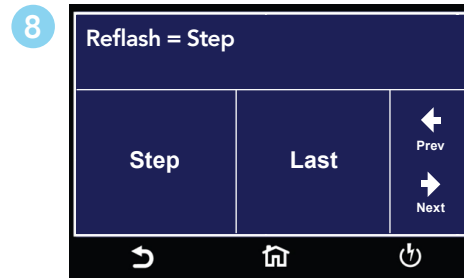

Select Reflash.

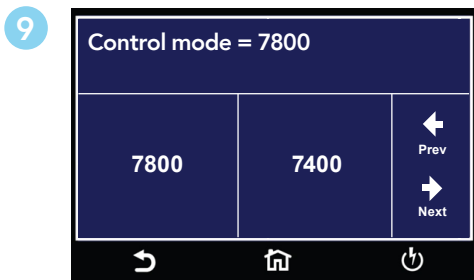

Select Control Mode.

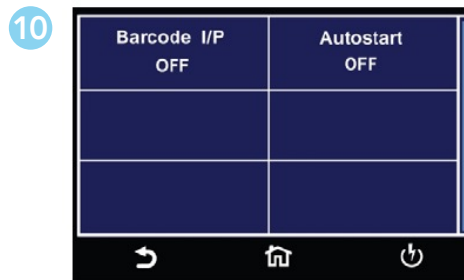

Barcode Menu.

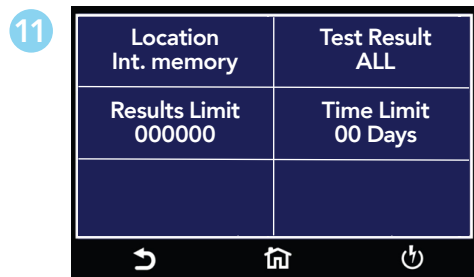

Results Data Menu.

## Hardware Parameter Descriptions

Descriptions of Hardware parameters are listed in the following table:

System Parameter	Setting	Description
Smart GFI	0 – 5 mA	<p>The high voltage power supply of the HypotULTRA is internally referenced to earth ground. Since the leakage current measuring circuit of the instrument monitors only current that flows through the return lead the possibility exists for current to flow directly from the high voltage output to earth ground without being measured. The SmartGFI (Ground Fault Interrupt) circuit monitors the current between the high voltage output and earth ground. Therefore, if you touch the high voltage lead and earth ground, the instrument will detect this hazardous condition and shut off immediately.</p> <p>SmartGFI goes beyond a standard GFI circuit by automatically determining the return configuration of the DUT (grounded or floating) and enabling or disabling depending on the situation. When the HypotULTRA's Return lead is floating, the SmartGFI circuit enables, protecting the test operator from electric shock. When the HypotULTRA's Return lead is earth grounded, the SmartGFI circuit disables and the instrument operates in a grounded return mode of operation. If the GFI were to remain active in this state, the instrument would continuously fail since all current is returning through earth ground. By disabling the SmartGFI circuit and operating in a grounded return mode, Hypot allows the user to perform tests on devices that have their chassis's earth grounded by the test fixture or test environment.</p>
PLC Remote	ON/OFF	Allows the user to initiate a test through the REMOTE INPUT on the rear panel of the instrument. If PLC Remote = ON the front panel TEST button is disabled and a test may only be started through the rear panel Remote I/O. If PLC Remote = OFF, the test must be initiated via the front panel TEST button.
Single Step	ON/OFF	Temporarily overrides the automatic connection feature. If Single Step = ON the instrument will pause after each step is completed. To continue the test sequence, press the TEST button to execute the next connected step. Each time the TEST button is pressed the next connected step will execute. If you press the RESET button before completing all connected steps, it will return the instrument to the original starting step. If a step fails and you wish to continue to the next step, do not press the RESET button but press the TEST button.
Fail Stop	ON/OFF	If Fail Stop = ON, a sequence of tests will stop if a failure occurs. If Fail Stop = OFF, the sequence of tests will continue to the end of the sequence regardless of whether or not a failure has occurred. If a failure has occurred, the red RESET button will light and alarm will sound indicating failure during the sequence. Pressing the RESET button will silence the alarm and reset the instrument.
Measurement	True RMS or Average	The Measurement function allows the user to set the instrument to either True RMS or Average measurement mode.
ProVOLT	ON/OFF	<p>The ProVOLT function allows for maintaining, stepping up or stepping down the voltage output between steps without the voltage dropping to 0V. If ProVOLT = ON, the output voltage will not drop to 0V between test steps.</p> <ol style="list-style-type: none"> <li>1. Test steps must be of the same test type (ACW, DCW, IR or –DCW). For example if an ACW test is followed by a DCW test, the ProVOLT function will not operate.</li> <li>2. If stepping up the voltage between steps, the ramp down parameter is ignored.</li> <li>3. If stepping down the voltage between steps, the ramp up parameter is ignored.</li> </ol>

<b>Baud Rate</b>	9600/19200/38400	Allows the user to select the baud rate for serial communication
<b>Reflash</b>	Step/Last	The Reflash function can be set to either STEP or LAST. If set to STEP, the display will be updated every 100ms. If set to LAST, the display will reflash when all steps have been completed. This feature cuts down the time between test steps in a multi-step test sequence by not updating the screen when a test is running WARNING – When Reflash is set to Last the screen
<b>Control Mode</b>	7800/7400	Allows user to select between AR 7800 Series and SE 7400 Series bus command structure

HypotULTRA® comes from the factory with the following default system parameters:

System Parameters		
<b>Hardware</b>	Smart GFI	0.0 mA or OFF
	PLC Remote	OFF
	Single Step	OFF
	Fail Stop	ON
	Measurement	Average
	ProVolt	OFF
	Barcode I/P	OFF
	Autostart	OFF
	Location	Int. Memory
	Test Results	ALL
	Results Limit	000000
	Time Limit	00 Days
	GPIB Port (Option 08)	8
<b>User Interface</b>	Results	Last
	Touch Sound	ON
	Alarm Volume	5
	Language	English
	Home Screen	Menu
	Color Style	Blue
	Dual TEST	OFF
<b>Security</b>	Security	OFF
<b>Cal Alert</b>	Cal Alert	ON

## Barcode

### Barcode I/P

The Barcode function allows you to connect a barcode scanner directly to the front panel of the instrument's barcode port. This is utilized to enter product and serial number information for testing.

To use this function, plug a USB type barcode reader into the barcode port on the front panel of the instrument. Once a USB barcode is plugged in, the instrument will notify you that a reader has been detected:

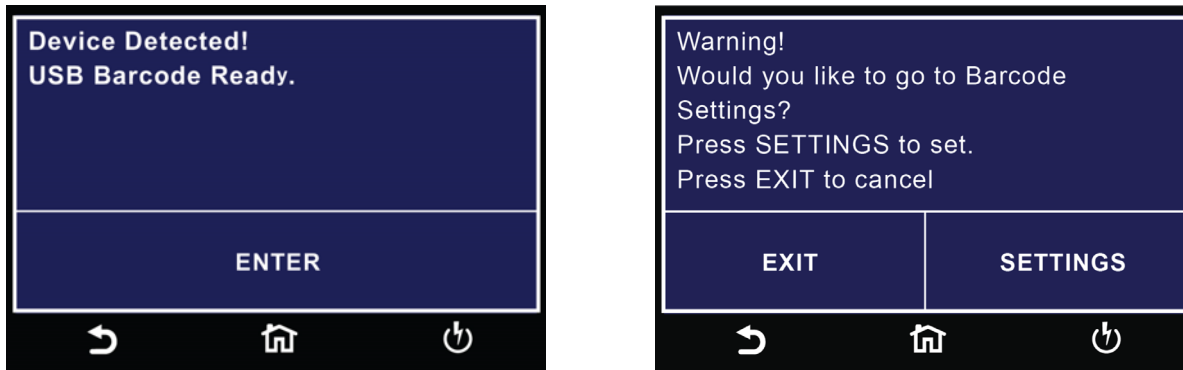

If there is a problem with the connection to the barcode reader or an incompatible device is plugged into the USB barcode port, the following message will appear:

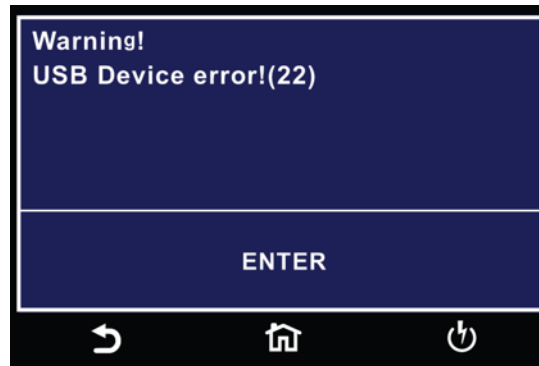

If the USB barcode device is removed while the instrument is powered on, the following message will appear:

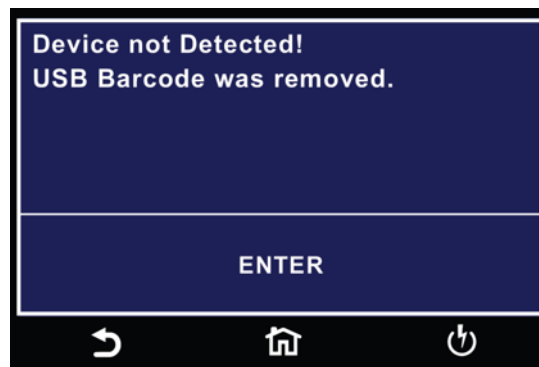

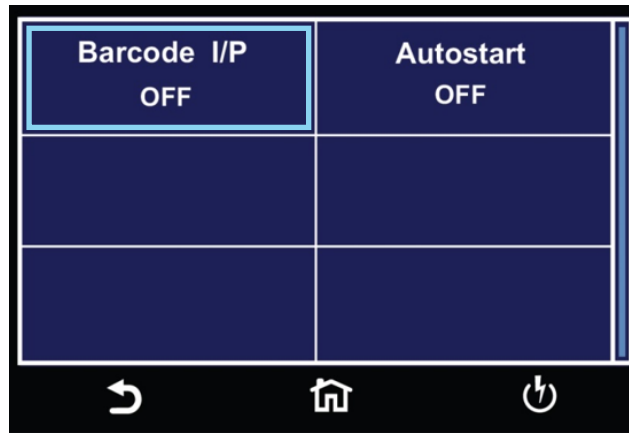

Barcode Menu

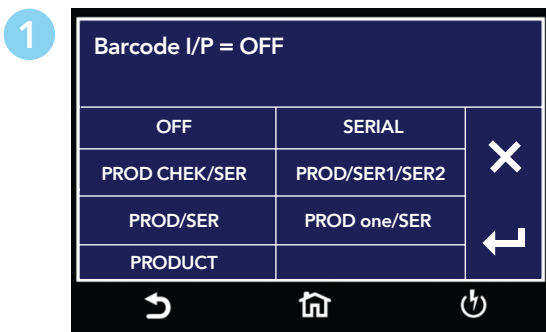

Select Barcode input option.

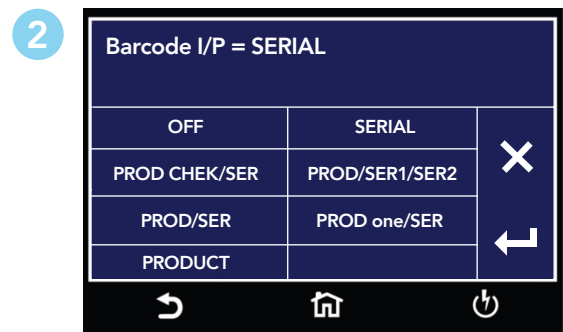

Select Barcode type.

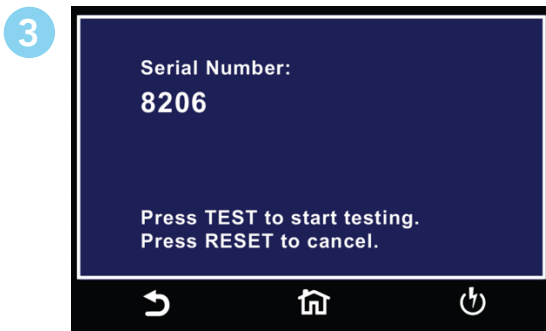

Example SERIAL # screen.

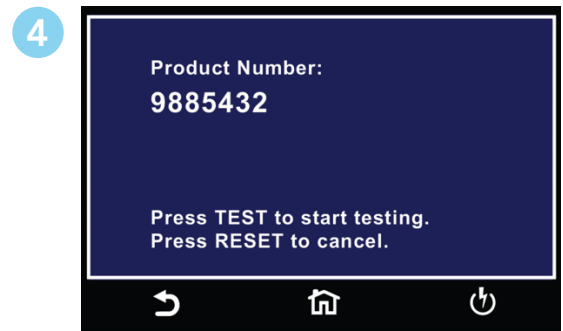

Example PRODUCT # screen.

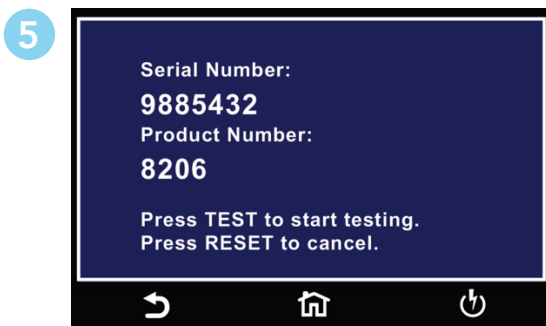

Example SER/PROD screen.



## Barcode Autostart

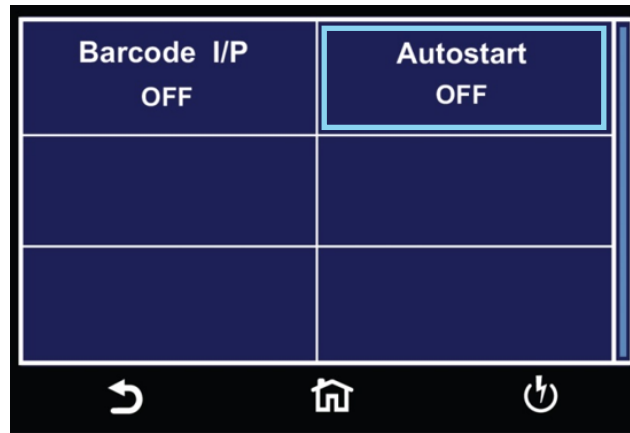

Barcode Menu

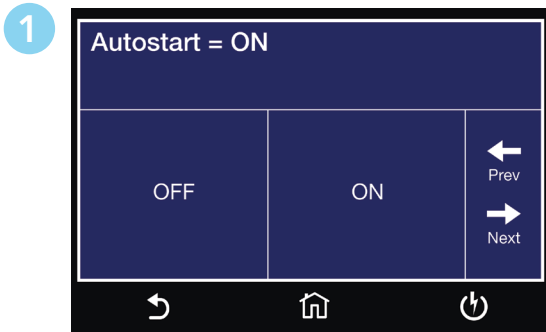

Select Autostart ON or OFF.

Mode	Autostart OFF	Autostart ON
<b>SERIAL</b>	When a serial number is scanned, user must press test. Serial number will be saved to the results.	Once serial number is scanned, previously loaded test file will automatically run. Serial number will be saved to the results.
<b>Prod CHEK/SER</b>	User will first scan product number followed by serial number. If the product number is associated with a test file, this file will be loaded. If no association exists between the product number and a test file, the unit will run previously loaded test file. The User must press test to run test. Product & serial numbers will be saved to results.	User must scan product number associated with test file or test will be aborted. User will then scan the serial number. To run a test the user will re-scan the product number. Product number and serial number will be saved to results.
<b>Prod/SER 1/SER 2</b>	User will scan product number followed by serial number 1, followed by serial number 2. If product number is associated with a test file, this file will be loaded. If no association exists between the product number and a test file, the unit will run the previously loaded test file. User must press test to run test. Product number, SER1 and SER2 will be saved to results.	User must scan product number associated with a test file or the audible beep will occur. User will then scan SER 1 then SER 2. The test will automatically begin after SER 2 is scanned. Product number, SER 1 and SER 2 will be saved to results.
<b>PROD/SER</b>	User will scan product number followed by serial number. If the product number is associated with a test file, this file will be loaded, if no association exists, the unit will run previously loaded test file. User must press test to run test. Product number and SN will be saved to results.	User must scan the product number associated with a test file or audible beep will occur. User will then scan the serial number and the test will automatically begin. Product and serial number will be saved to the results.
<b>PROD one/SER</b>	User will scan the product number once and if it is associated with a test file it will load the file permanently allowing you to just scan serial numbers. If a new product number is scanned the unit will load the test file associated with the new product number. It will wait for a serial number scan to be ready to run the test. User must press test to run test. Product number and SN will be saved to results.	User will first scan product number associated with test file to load the test file. This test file will be loaded permanently allowing you to just scan serial numbers. The test will begin immediately after a serial number is scanned. If a new product number is scanned the unit will load the new file. Product and serial number will be saved to results.
<b>PRODUCT</b>	User must scan the product number and the test file associated with the product number will be loaded. The unit will make an audible beep if the product number is not associated with a test file. The user must press test to start test. Product number will be saved to results.	User will scan the product number associated with a test file. The test will run immediately after scan. Product number will be saved to results.

The maximum length of the barcode Model/Serial number is limited to 21 characters.

## Results Setup

Select Int. memory if you wish to store the test results on the onboard instrument memory. Select USB disk if you wish to save the test results on an external USB flash drive. For best results use the USB flash drive provided by Associated Research.

Select PASS to save the results of the steps that passed. Select FAIL to save the results of the steps that failed. Select ALL to save all the test results. Selecting NONE will not save any results to the internal memory.

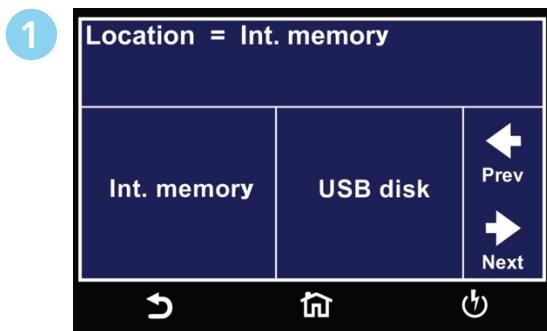
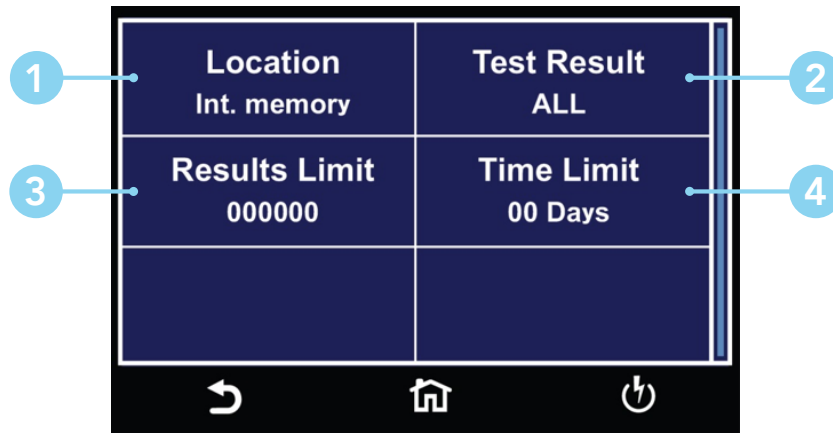
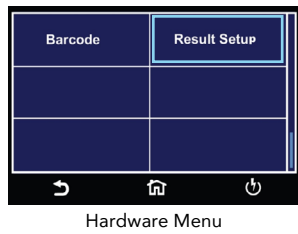

Select Location for Result Data.

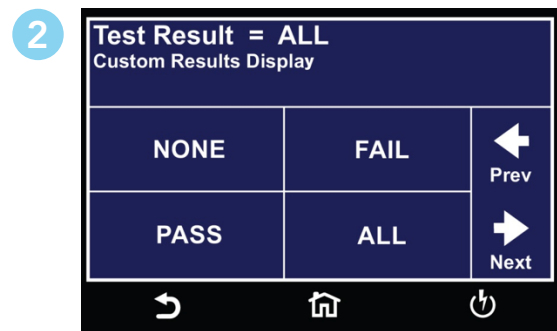

Select type of Test Results to be saved.

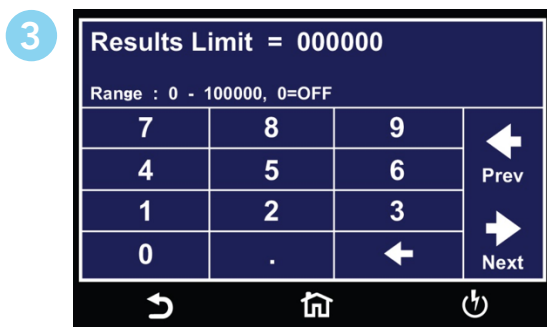

Enter Results Limit.



Enter Time Limit.

You can set the Results Limit. Select from 0 up to 100000 with 0 being OFF. Selecting 0 will set the Results limit to OFF which means you can store as many results as desired until you reach the maximum capability of 100000 results.

# Internal Memory

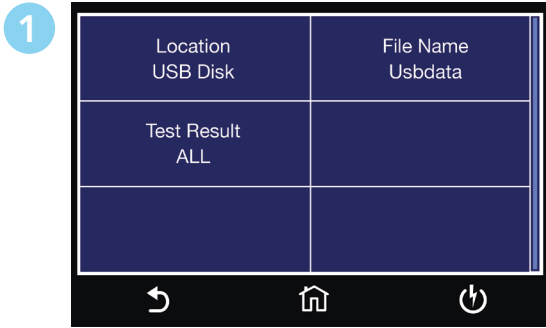

Result Setup USB DISK Menu.

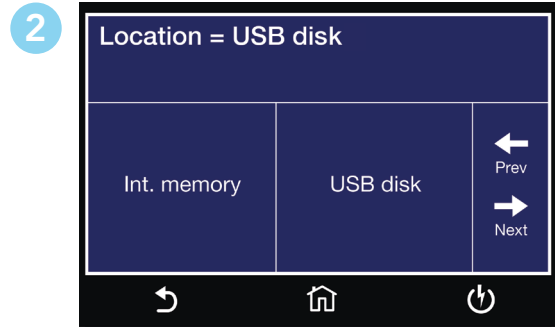

Select Location for Result Data.



Enter File Name.

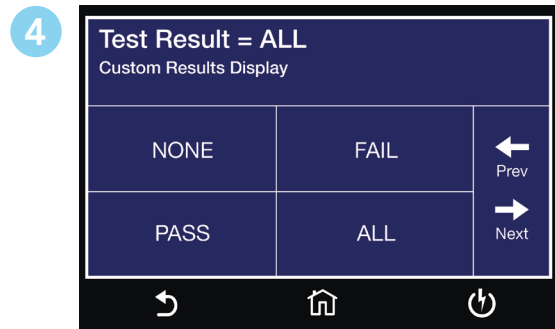

Select type of Test Results to be saved.

## 2. Setup Tests

The following sequence describes the steps necessary to create a test file, program the test parameters and save the test file:



**TAP SETUP TESTS**  
Home Screen

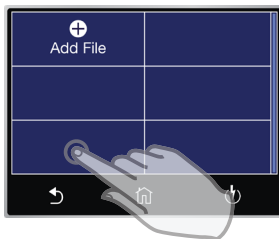

**TAP ADD FILE**  
File Screen



**ADD FILE NAME**  
Tap the ENTER (↵) key to save your selection

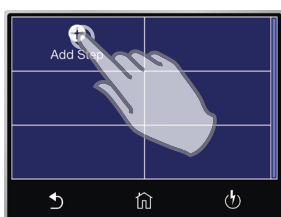

**TAP ADD STEP**  
Add Step



**TAP TEST SETTING**  
Tap the test parameter you would like to edit. Swipe up and down to scroll through test parameters.

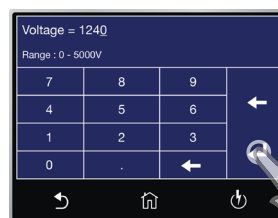

**EDIT PARAMETERS**  
Tap parameter values to edit individually. After you adjust each parameter, tap ENTER (↵) arrow key to save changes.



**ADJUST PARAMETERS**

Scroll through each parameter to adjust values based on your application.



**EXIT PARAMETERS**

Press the Test Screen button to exit out of Parameters.

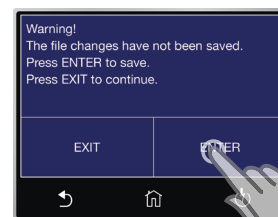

**SAVE FILE CHANGES**

Press ENTER to save your file changes. You will be redirected to the Test Screen.

## 2.1 Setup Continuity Test

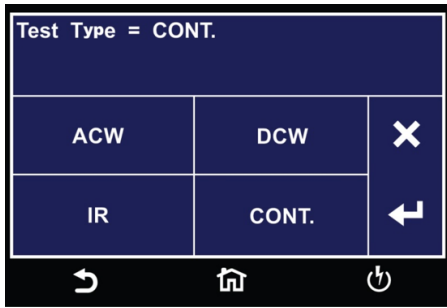

Select CONT. Test type.

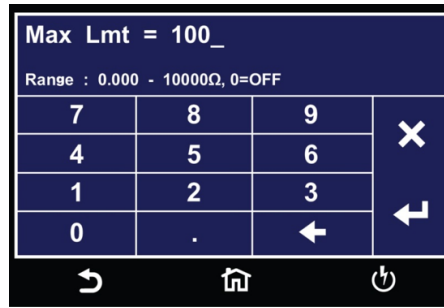

Enter **Max Limit** for resistance.

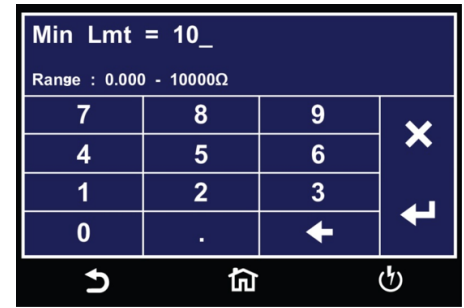

Enter **Min Limit** for resistance.

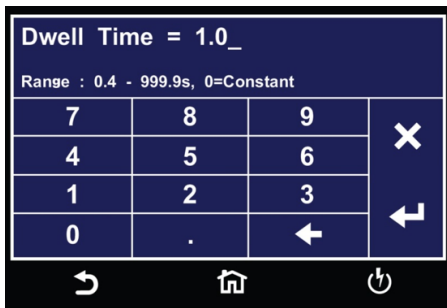

Enter test **Dwell Time**.

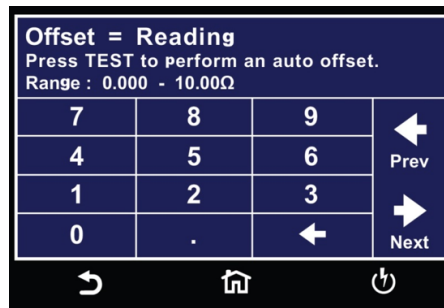

Enter **Offset** value to manually set Offset or Press TEST to perform auto offset.

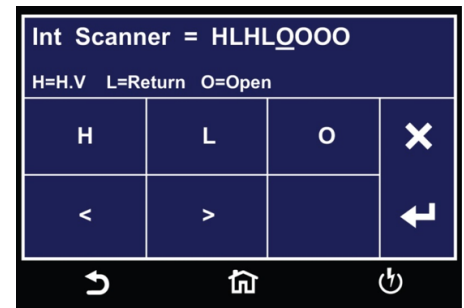

Select **Scanner** settings.



Enter text for **Prompt**.

## 2.2 Setup Ground Bond Test (7804 and 7854 only)

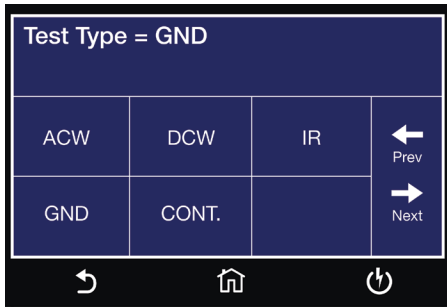

Select **GND** Test type.

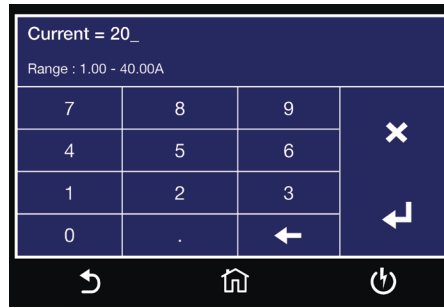

Enter test **Current** value.

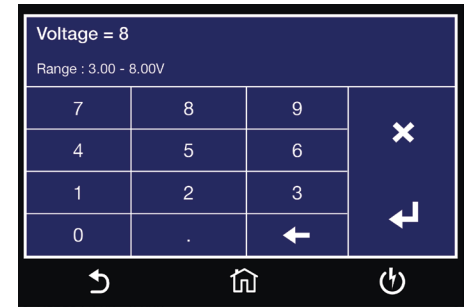

Enter test **Voltage** value.

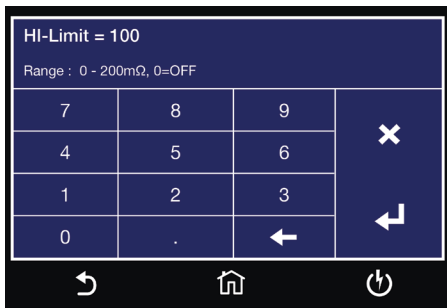

Enter **HI-Limit** for resistance.

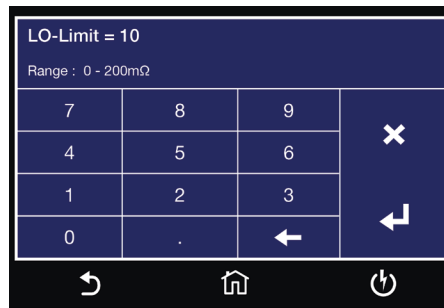

Enter **LO-Limit** for resistance.



Enter **HI-Limit** for Voltage.

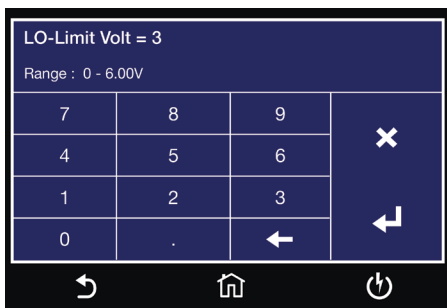

Enter **LO-Limit** for Voltage.

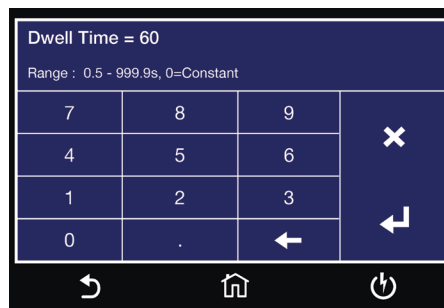

Enter test **Dwell Time**.

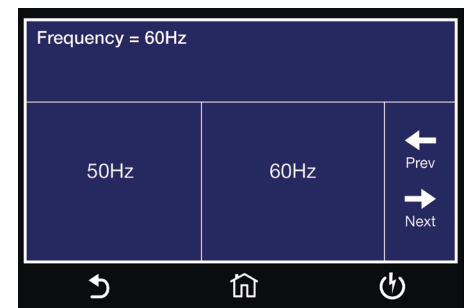

Select test **Frequency**.

Continued on next page →

## Setup Ground Bond Test Continued

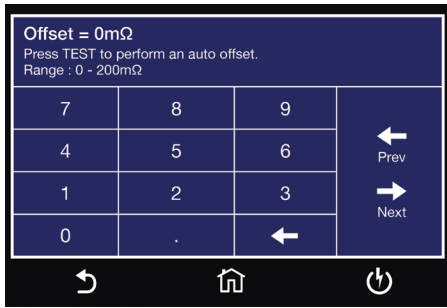

Enter **Offset** value to manually set Offset or Press TEST to perform auto offset.

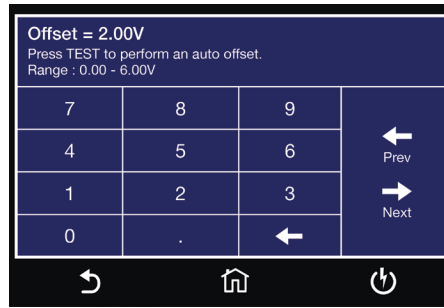

Enter **Offset** value to manually set Offset or Press TEST to perform auto offset.

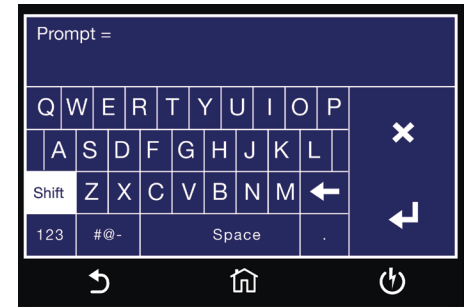

Enter text for **Prompt**.

## Offset Connections

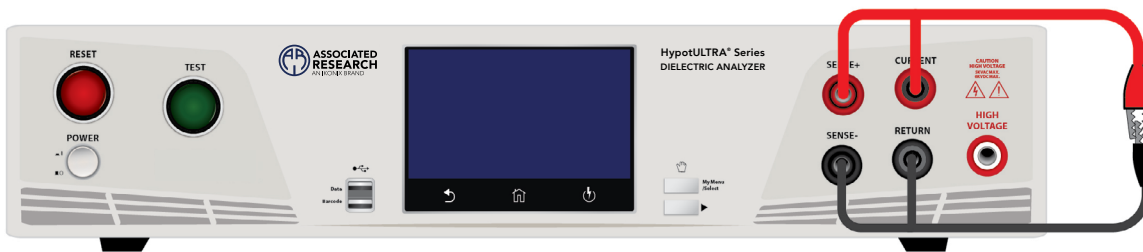

Connect the Red and Black alligator clips together.

To perform mOhms or Voltage Auto Offset short Red Current/Sense+ Lead with Black Return/Sense- Lead.



Push TEST button. The instrument will Auto Offset measurements and save the value to the test step.\*

\*Note: Performing either mOhms or Voltage Auto Offset will set two values, mOhms and Voltage offset parameters of the test step.



## 2.3 Setup AC Withstand Test

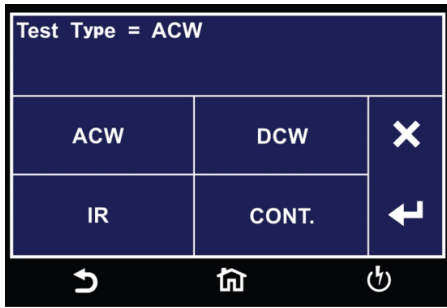

Select ACW Test type.

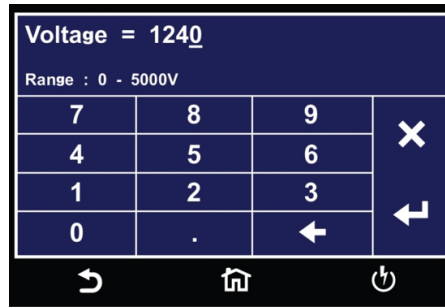

Enter AC test Voltage.

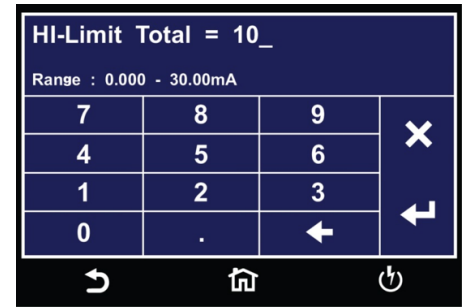

Enter HI-Limit Total.

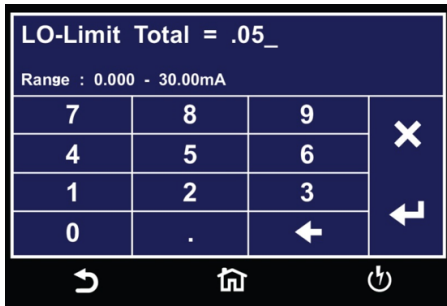

Enter LO-Limit Total.

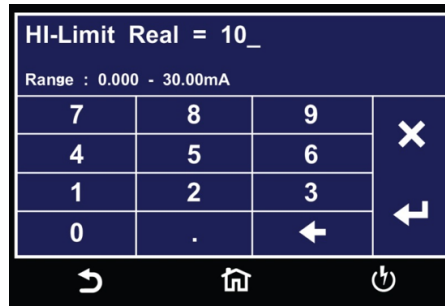

Enter HI-Limit Real.

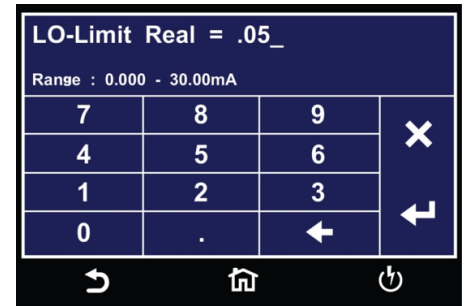

Enter LO-Limit Real.

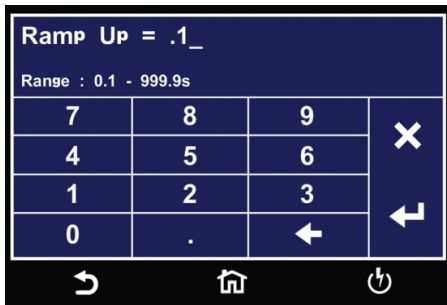

Enter test Ramp Up time.

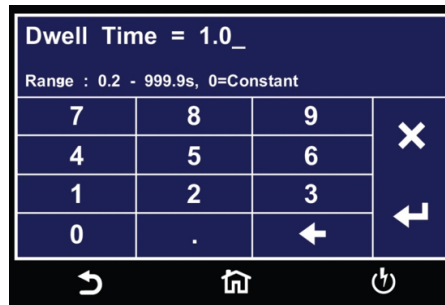

Enter test Dwell time.

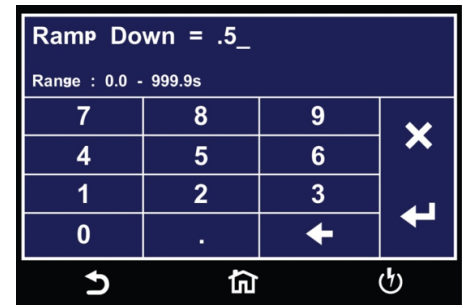

Enter test Ramp Down time.

Continued on next page →

## Setup AC Withstand Test Continued

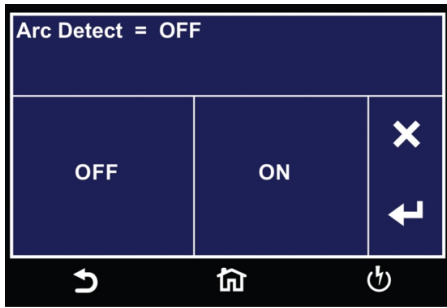

Select Arc Detect ON or OFF.

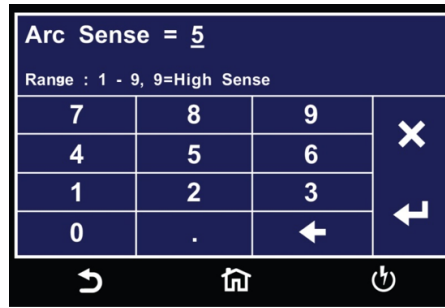

Enter Arc Sense value.

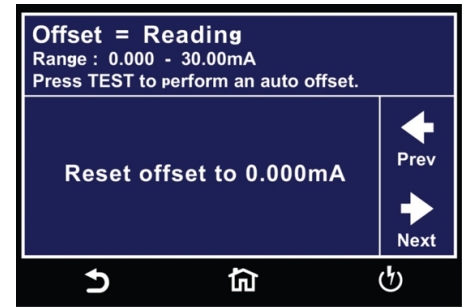

Press TEST button to perform an auto offset or select Reset offset to 0.000mA to reset Offset parameter.

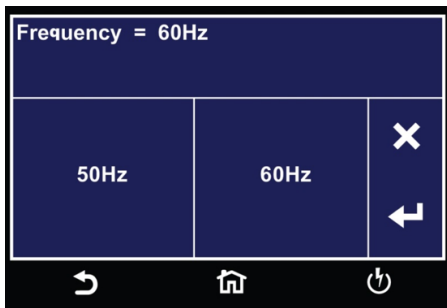

Select test Frequency.

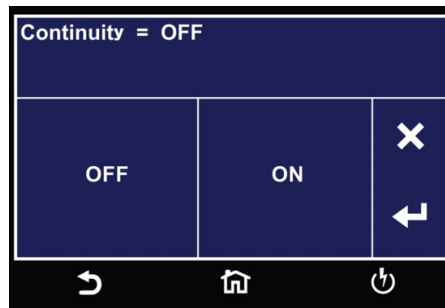

Select Continuity ON or OFF.

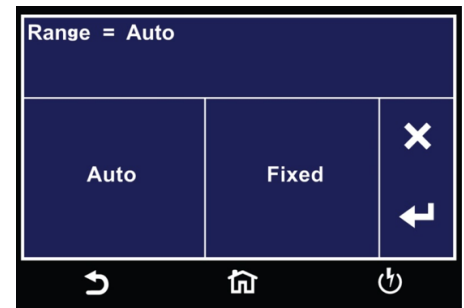

Select Range Auto or Fixed.

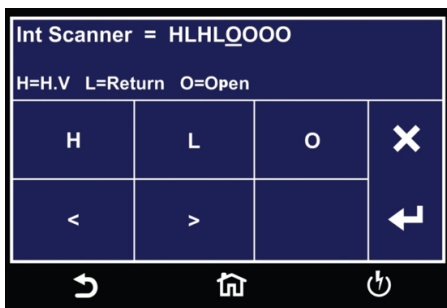

Select Scanner channel settings.

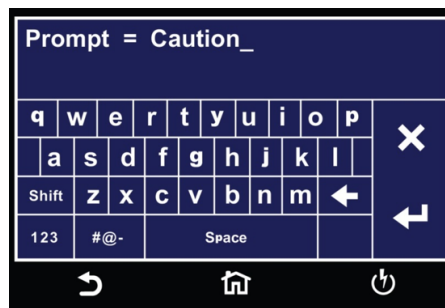

Enter text for Prompt.

## 2.4 Setup DC Withstand Test

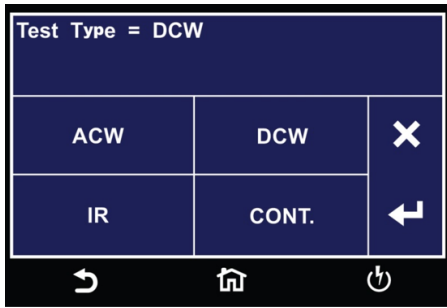

Select DCW Test type.

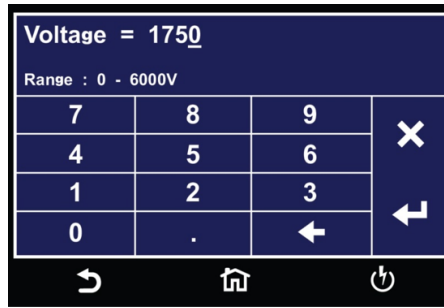

Enter DC test Voltage.

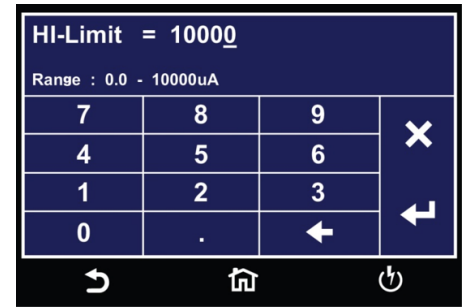

Enter HI-Limit.

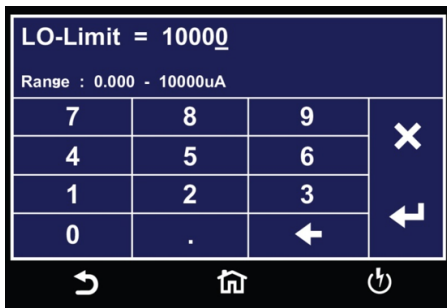

Enter LO-Limit.

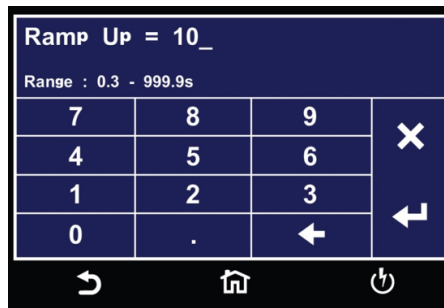

Enter test Ramp Up time.

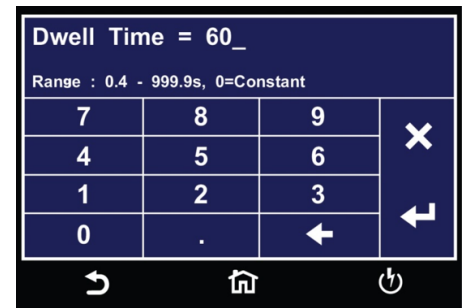

Enter test Dwell Time time.

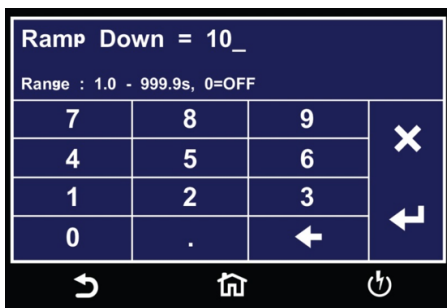

Enter test Ramp Down time.

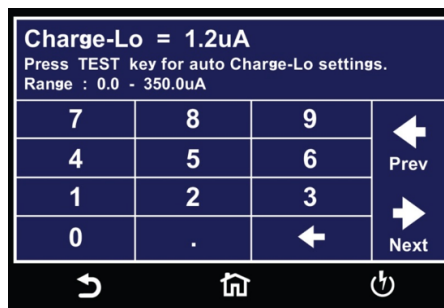

Enter Charge-LO® value to manually set Charge-LO or Press TEST to perform auto Charge-LO.

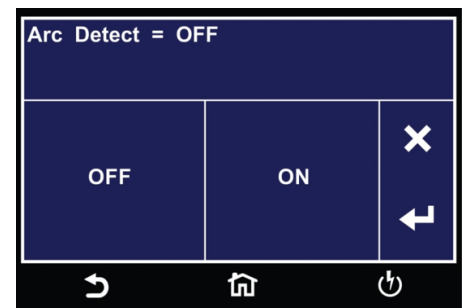

Select Arc Detect ON or OFF.

Continued on next page →

## Setup DC Withstand Test Continued

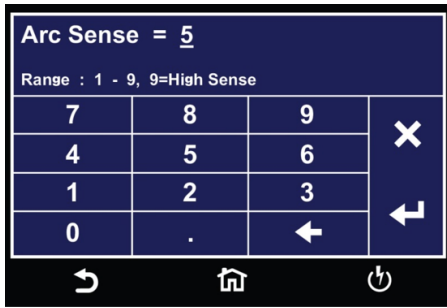

Enter **Arc Sense** value.

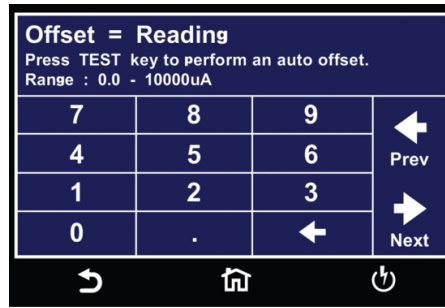

Enter Offset value to manually set Offset or Press TEST to perform auto offset.

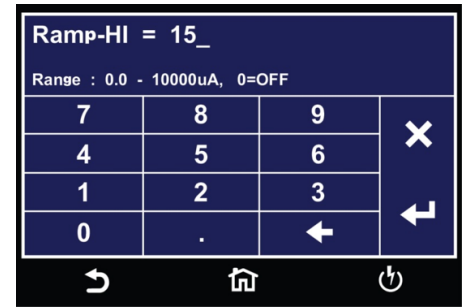

Enter **Ramp-HI**® value.

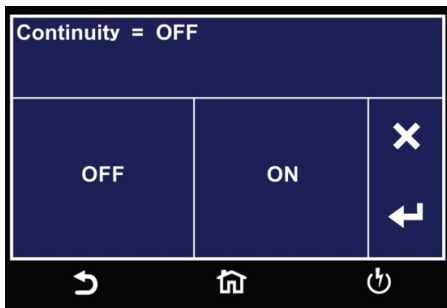

Select **Continuity** ON or OFF.

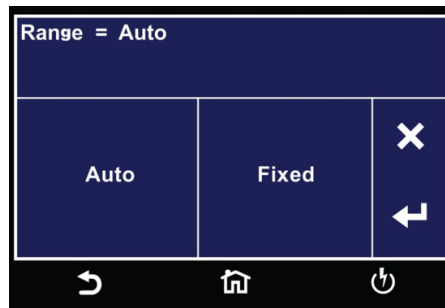

Select current Range Auto or Fixed.

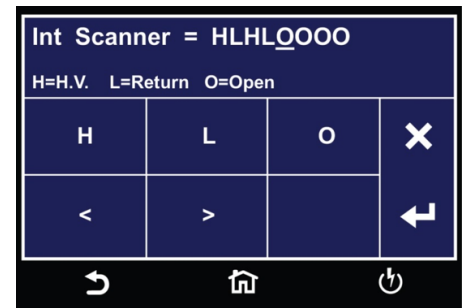

Select **Scanner** channel settings.

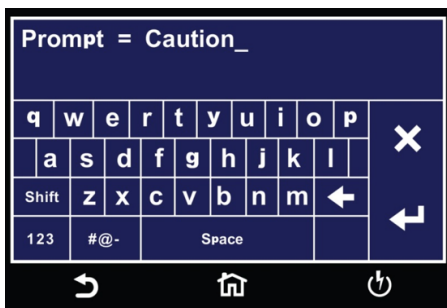

Enter text for **Prompt**.

## 2.5 Setup Insulation Resistance Test

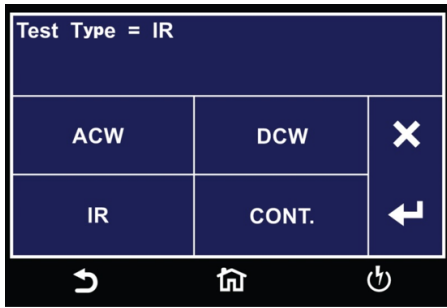

Select IR Test type.

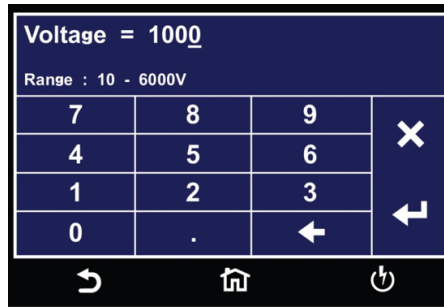

Enter IR test Voltage.

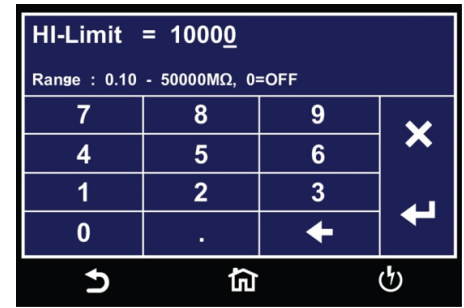

Enter HI-Limit.

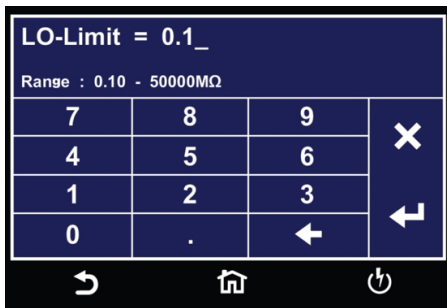

Enter LO-Limit.

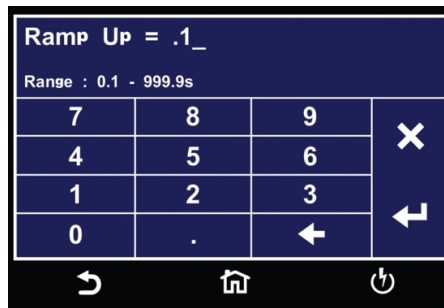

Enter test Ramp Up time.

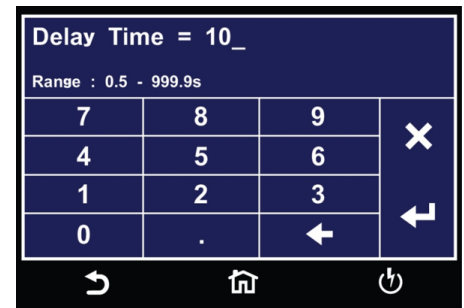

Enter test Delay Time.

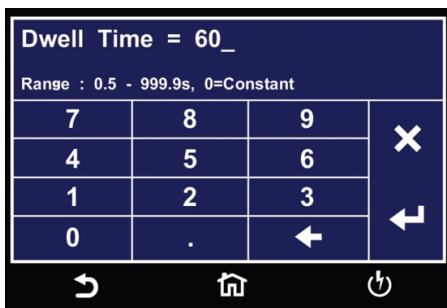

Enter test Dwell Time.

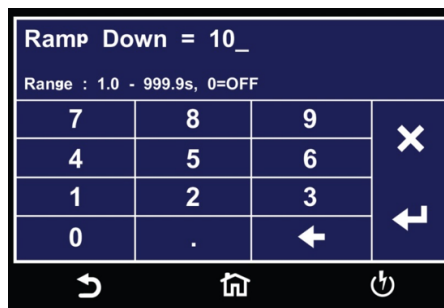

Enter test Ramp Down time.

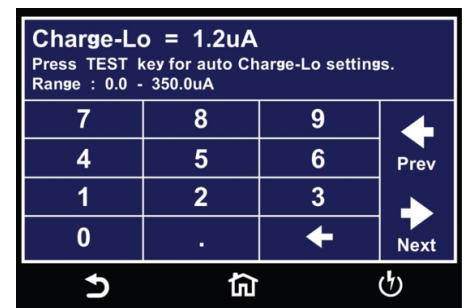

Enter Charge-Lo value to manually set Charge-Lo or Press TEST to perform auto Charge-Lo.

Continued on next page →

## Setup Insulation Resistance Test Continued

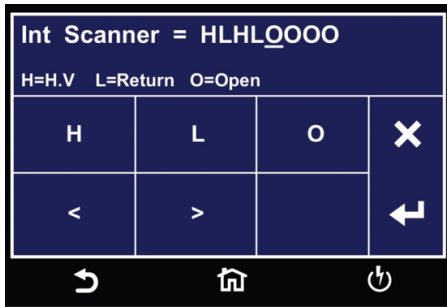

Select **Scanner** channel settings.

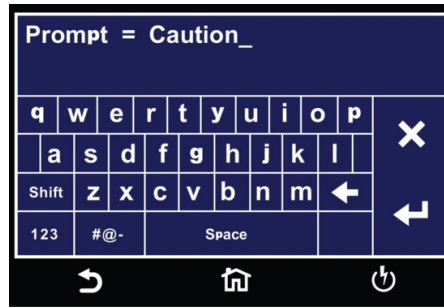

Enter text for **Prompt**.

## Default Test Parameters

Each of the test types (AC Withstand, DC Withstand, Insulation Resistance, Continuity and Ground Bond) have specific default test parameters that automatically load when you select the test from the Parameter Edit screen. The following table is a listing of the Default Parameters for each of the different types of tests that are available in the HypotULTRA. The Default Parameters are as follows:

Test Parameter	Test Type	Description
ACW	Voltage	1240V
	HI-Limit T	10.00mA
	LO-Limit T	0.000mA
	HI-Limit R	10.00mA
	LO-Limit R	0.000mA
	Ramp UP	0.1s
	Dwell	1.0s
	Ramp DN	0.0s
	Arc Detect	OFF
	Arc Sense	5
	Offset	0.000mA
	Frequency	60Hz
	Continuity	OFF
	Range	Auto
	Scanner (Option)	00000000
	Prompt	

Continued on next page →

## Default Test Parameters Continued

Test Parameter	Test Type	Description
DCW	Voltage	1500V
	HI-Limit	10000uA
	LO-Limit	0.0uA
	Ramp UP	0.4s
	Dwell Time	1.0s
	Ramp Down	0.0s
	Charge-Lo	0.0uA
	Arc Detect	OFF
	Arc Sense	5
	Offset	0.0uA
	Ramp-Hi	0.0uA
	Continuity	OFF
	Range	Auto
	Low Range	OFF
	Scanner (Option)	OOOOOOOO
	Prompt	
IR	Voltage	500V
	HI-Limit	0.00MΩ
	LO-Limit	0.10MΩ
	Ramp Up	0.1s
	Delay Time	0.5s
	Dwell Time	0.5s
	Ramp Down	0.0s
	Charge-LO	0.000uA
	Scanner (Option)	OOOOOOOO
	Prompt	
Ground Bond	Current	25.00A
	Voltage	8.00V
	HI-Limit	100mΩ
	LO-Limit	0mΩ
	HI-Limit V	6.00V
	LO-Limit V	0.00V
	Dwell Time	1.0s
	Frequency	60Hz
	Offset	0mΩ
	Offset	0.00V

Continued on next page →

## Default Test Parameters Continued

Test Parameter	Test Type	Description
CONT	Max Lmt	1000Ω
	Min Lmt	0.000Ω
	Dwell Time	1.0s
	Offset	0.000Ω
	Scanner (Option)	00000000
	Prompt	



## Test Parameters Description

Test Parameter	Test Type	Description
Voltage	ACW, DCW, IR	The voltage that is output at high voltage to return terminals during a test.
Voltage	GND	No load voltage applied between high current and return terminals during Ground Bond test.
Current	GND	The current applied during Ground Bond Test.
Hi-Limit Volt	GND	The maximum voltage drop threshold that triggers a failure when exceeded.
Lo-Limit Volt	GND	The minimum voltage drop threshold that triggers a failure when not exceeded.
HI-Limit T	ACW	Total current maximum limit. The maximum current threshold that triggers a failure when exceeded.
LO-Limit T	ACW	Total current minimum limit. The minimum current or resistance threshold that triggers a failure when not exceeded.
HI-Limit R	ACW	<p>Real current maximum limit. The maximum current or resistance threshold that triggers a failure when exceeded.</p> <p><b>Real Current</b>            The AC Real Current function allows you to monitor only the real portion of the leakage current and ignores any reactive components due to capacitance in the device under test. It is important to recognize that the total current is the vector sum of the reactive and real current, not the direct addition of the two components. As in a right triangle, the total current is the square root of the sum of the squares of the real and reactive currents.</p> <p>Since the real component is usually much smaller than the reactive current, a doubling of the real current increases the total current by only a small amount. Unless the two components are separated, a doubling of the real leakage current can go virtually undetected by a total current measurement.</p> <p>Because Real Current is installed in HypotULTRA, additional parameter selections are added to the ACW test parameters. The additional test parameters are HI-Limit R (Real Current Maximum limit), LO-Limit R(Real Current Minimum Limit) and Display. The standard total current limits have a "T" next to them indicating total current.</p> <p>The AC Real Current function allows the operator to view both real and total current simultaneously. The Display parameter allows you to select which meter will display the real and total current. When the display parameter is set for Total, the large current meter will display the total current and the small current meter display the real current. The opposite is true when you set the display for Real.</p>

Continued on next page →

## Test Parameters Description Continued

Test Parameter	Test Type	Description
LO-Limit R	ACW	Real current minimum limit. The minimum current or resistance threshold that triggers a failure when not exceeded.
HI-Limit	GND, ACW, DCW, IR	The maximum current or resistance threshold that triggers a failure when exceeded.
LO-Limit	GND, ACW, DCW, IR	The minimum current or resistance threshold that triggers a failure when not exceeded.
Max-Lmt	Continuity	The maximum resistance threshold that triggers a failure when exceeded.
Min-Lmt	Continuity	The minimum resistance threshold that triggers a failure when not exceeded.
Ramp Up	ACW, DCW, IR	The length of time that is allowed for the test voltage to climb from 0 to the programmed test voltage.
Dwell Time	GND, ACW, DCW, IR	The length of time that is allowed for the programmed test voltage to be applied.
Delay	IR	The length of time that the programmed test voltage is applied but no judgment of the set parameters is made. Judgment of the parameters is not made until the end of the delay time.
Ramp Down	ACW, DCW, IR	The length of time that is allowed for the test voltage to decay from programmed test voltage to 0.

Continued on next page →

## Test Parameters Description Continued

Test Parameter	Test Type	Description
Charge-LO	DCW, IR	<p>Use the Charge-LO function to check if the cables are connected properly at the beginning of a test. A capacitive DUT will draw charging current on the DC Withstand test when the Output is activated. If the charging current is lower than the setting, the test cables may not be connected properly. The instrument can set the Charge-LO parameter manually or automatically. To manually set the Charge-LO current, use the touchscreen keypad to enter the value. To automatically set the Charge-LO current select the Charge-LO parameter and connect all test leads to the DUT as you would when performing an actual DCW test. Press the TEST button on the front panel of the instrument.</p> <div style="border: 1px solid black; background-color: #FFD700; padding: 5px; display: inline-block; margin-bottom: 10px;"><b>CAUTION</b></div> <p>Please be aware that the program will activate high voltage on the output connector while the TEST button is pressed.</p> <p>S'il vous plaît soyez conscient que le programme va activer haute tension sur le connecteur de sortie tandis que le bouton TEST est pressé.</p> <p>The program will read the charging current of the DUT and set the Charge-LO current at approximately one half (1/2) of the reading. The instrument will beep and the new value will automatically be updated in the field. You do not need to select the ENTER key for the new parameter to be accepted.</p>
Ramp-HI	DCW	The Ramp-HI function is active during the Ramp period only. Ramp-HI will allow current higher than the normal HI-Limit current setting of the DC Withstand Voltage test to avoid false failure due to charging current.
Arc Sense	ACW, DCW	The maximum allowable threshold for arcing. The numbers 0 through 9 correspond to the different arc sensitivity levels, 1 meaning the maximum threshold of allowable arcing, 9 meaning the minimum threshold of allowable arcing, and 0 being OFF. Arc detection is not required for testing.
Frequency	ACW, GND	The frequency of the applied voltage or current.
Continuity	ACW, DCW	This function checks for a connection between the Cont. Check and Return lead. This is a basic DC continuity check that measures the continuity value but does not display it. Continuity may be turned ON or OFF.

Continued on next page →

## Test Parameters Description Continued

Test Parameter	Test Type	Description
Offset	Continuity, ACW, DCW, GND	<p>Used to factor out leakage current or resistance due to test leads or test fixture. Set manually or measure automatically. To automatically set an Offset value, set the output voltage, current, and frequency to the values you will use on the DUT and connect the test cables, test fixture, or Scanner channel with fixturing to the instrument. Next, for the Ground Bond and Continuity test, short the ends of the test cables and press the TEST button. For ACW or DCW tests leave the end of the test cable open, as this is an open leads test and press the TEST button. The instrument will beep and automatically update the new value in the field. You do not need to select the ENTER key for the new parameter to be accepted. For the Ground Bond, performing either milli-ohm or voltage auto-offset will automatically update both mill-ohm and voltage offset values.</p> <div data-bbox="846 722 1138 810" style="background-color: #FFD700; padding: 5px; display: inline-block;"><b>CAUTION</b></div> <p data-bbox="1149 722 1555 842">Please be aware that the program will activate high voltage on the output connector while the TEST button is pressed.</p> <p data-bbox="846 877 1560 972">Note: Do not connect the DUT to the instrument when performing an offset. This will create erroneous results when you perform a test.</p>
Scanner or EX Scanner	All	<p>(This parameter will only be seen on units equipped with a scanner). This parameter allows for setup of multiple Scanner channels. The three different selectable Scanner states are L (scanner channel set to the return point), H (scanner set to the high voltage point) and O (OFF).</p>
Prompt	All	<p>The Prompt function allows you to insert a short line of text in a step. The Prompt will appear on the screen before the step is initiated and remains on the screen until you press the TEST button. After you press the TEST button, the Prompt will clear and the step will initialize.</p>

### View Test Files

Once you have programmed and saved all tests, navigate to the Main Menu. Select the Setup Tests icon and select the test file that you previously created. The screen should display all test steps that you have programmed in this test file. For example:

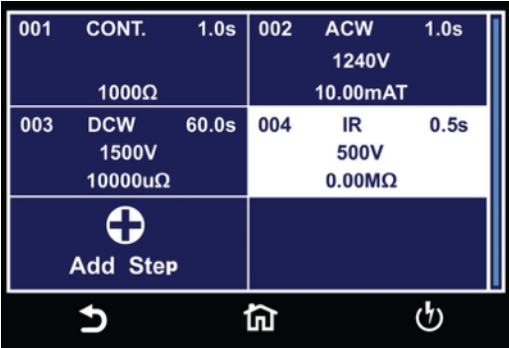

### Edit Test Files

Once you have programmed and saved all test files you can edit these files from the Setup Test menu. From the main menu select Setup Test. The next screen will display all the test files that are stored on the instrument memory.

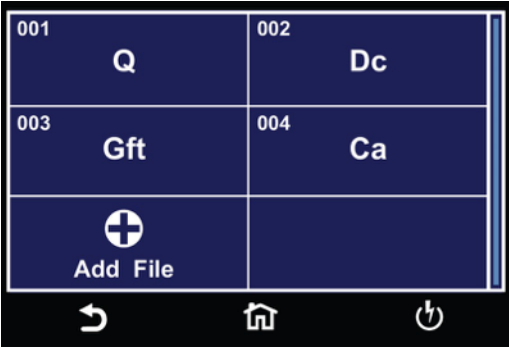

To edit test files touch and hold the screen on a test file name and the screen should change to the following:

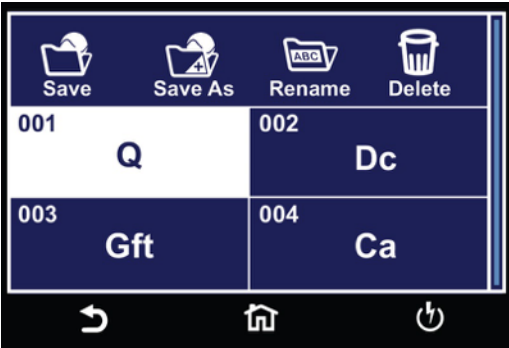

Select the test file and choose the operation you wish to perform from the following:

<b>Save</b>	Make changes to an existing test file and save the changes.
<b>Save As</b>	Edit an existing test file and save the test file with a different name.
<b>Rename</b>	Rename an existing test file.
<b>Delete</b>	Delete an existing test file.

If you choose to delete an existing test file a confirmation screen will appear as follows:



Select Exit to cancel deleting the test file or Enter to confirm the action.

### 3. Perform Tests

From the main menu select the Perform Test icon and the Perform Test screen will appear.

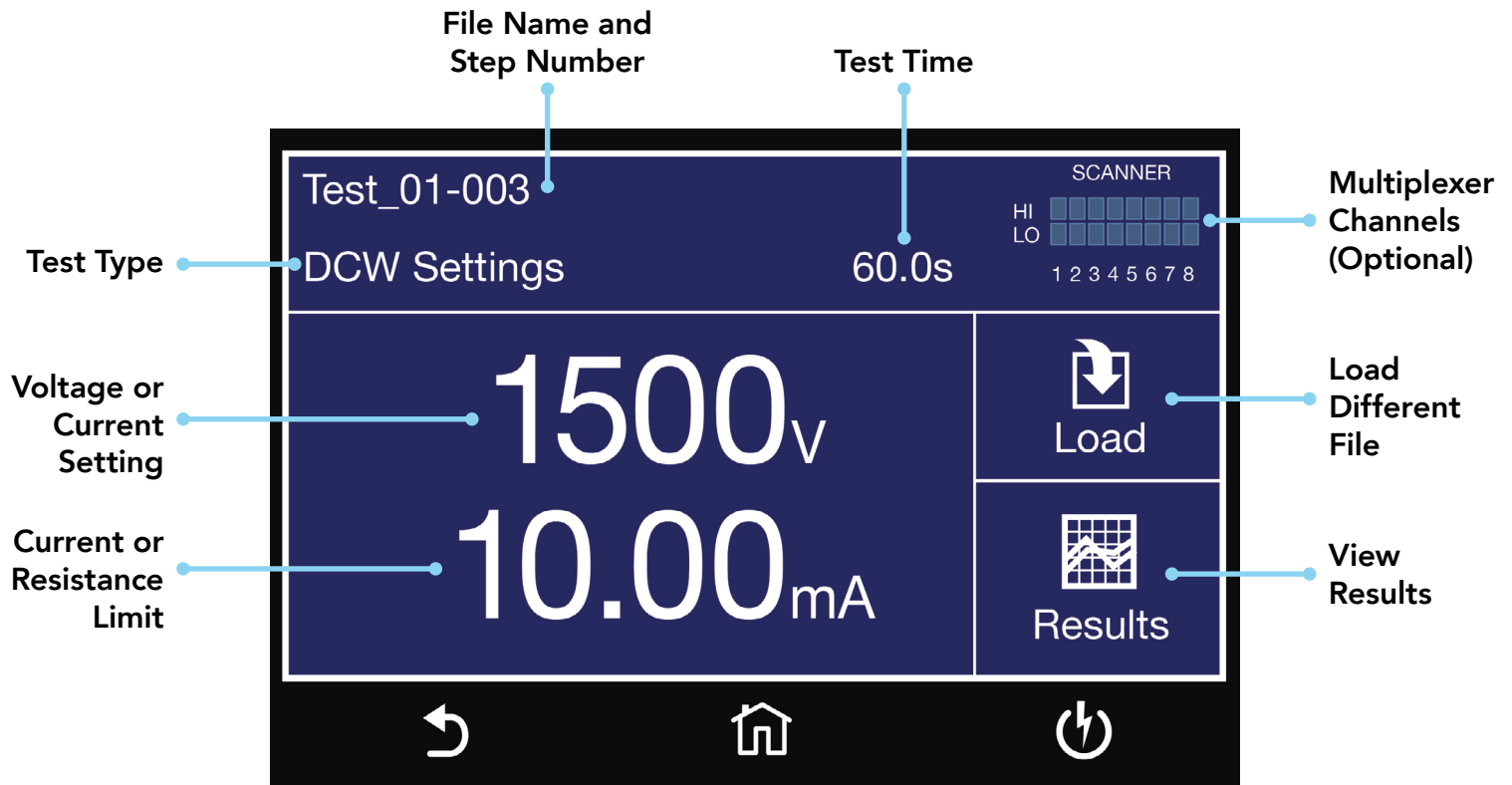

Perform Tests Screen

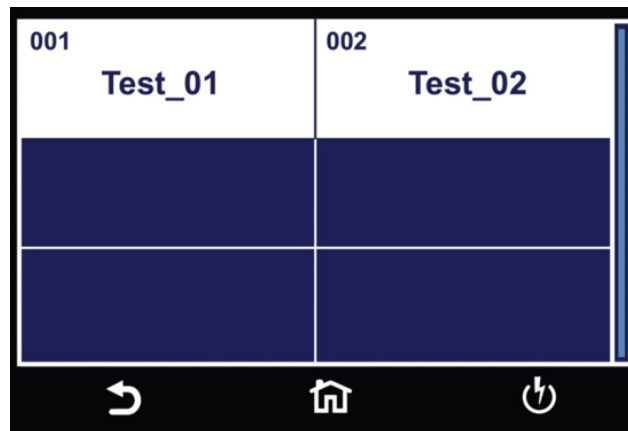

Load Test screen, if there are multiple test files saved in the instrument select the Load icon and all the test files will be displayed. You can select the test file and the first test step in the selected test file will be displayed.

## Instrument Connections

You may connect the test leads and the adaptor box to the receptacles located on the front or back of HypotULTRA. These receptacles are wired in parallel and you can use either depending upon the application.

### Test Lead Connections (7804/7854)

- 1 Plug the black return lead (P/N 38490) into the Return terminal. Plug black sense lead into the Sense (-) terminal.
- 2 Attach the clip-terminated end of the return lead to the dead metal on the chassis of the DUT.
- 3 Connect the High Voltage lead (P/N 4040A-08) into the high voltage terminal on the front panel of the instrument.
- 4 Attach the high voltage lead to the current-carrying conductors of the DUT.
- 5 Plug the sense lead into the sense (+) terminal and the high current test lead into the Current terminal. These two red leads act as the high current output.
- 6 Clip the other end to the ground pin of the DUT line cord.

### Class I Product

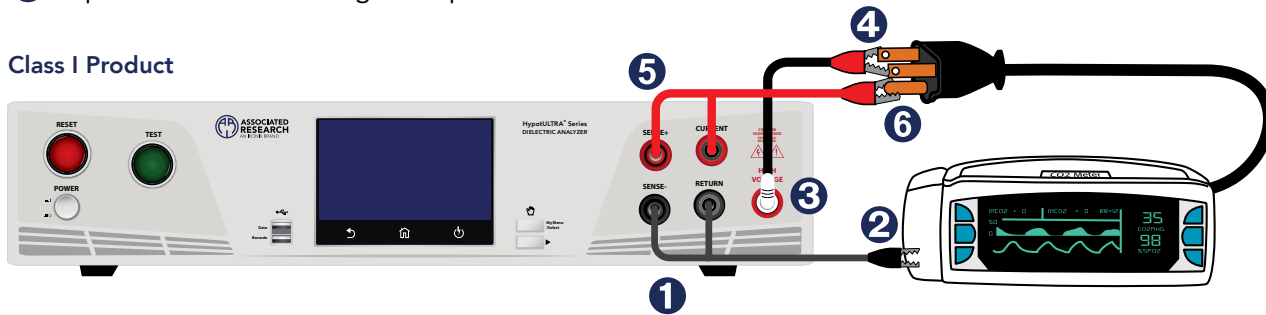

**Did you know?** If necessary, a 10 x 20 cm piece of foil can be attached to the enclosure to simulate a full hand contact to the DUT. This foil acts as the return point. The return and sense (-) terminal are attached to the foil. Always check to make sure you made a good connection between the DUT and the return clip.

### Class II Product

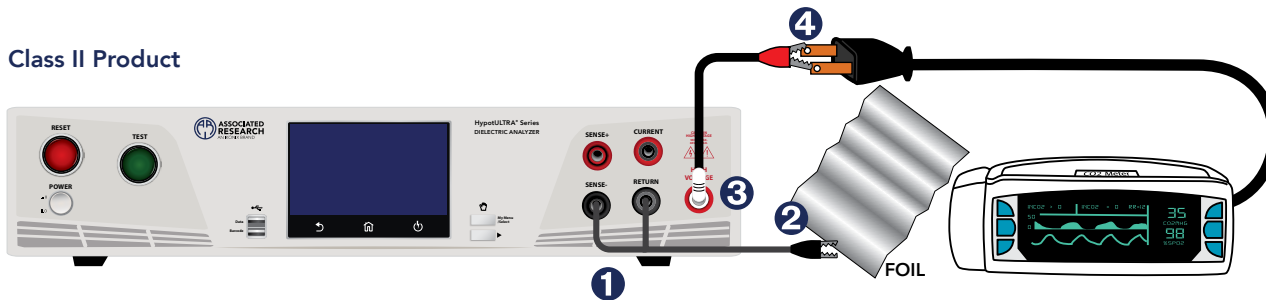

Continued on next page →



## Instrument Connections Continued

### Test Lead Connections (7820, 7850, and 7800)

If there is no ground circuit on your DUT, you may use the test leads to connect the HypotULTRA to your DUT. Turn off the Continuity function for this connection.

- 1 Plug the black ground return lead (P/N 2100A-13) into the Return terminal on the front panel of the instrument.
- 2 Connect the high voltage lead (P/N 4040A-08) into the High Voltage terminal on the front panel of the instrument.
- 3 Connect the black ground return lead (P/N 2100A-13) to the dead metal on the chassis of the DUT. Always check to be sure a good connection has been made between the DUT and the return clip.
- 4 Attach the high voltage lead (P/N 4040A-08) to the current carrying conductors of the DUT.

After you make the proper connections, you can initiate a test from the front panel of the HypotULTRA by pressing the green TEST button. Press the red RESET button to abort a test in process.

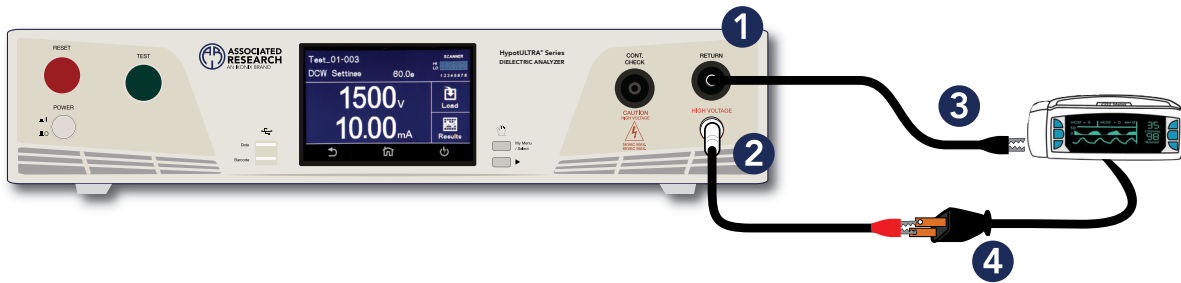

## Adapter Box Connections (7804/7854)

- 1 Connect the ground return clip (P/N 38490) to the dead metal on the chassis of the DUT. Plug the sense lead into the Sense (-) terminal. Plug the return lead into the Return terminal. Always check to make sure a good connection is made between the DUT and the return clip.
- 2 Using the output ports on the front panel, plug the black high voltage lead in the High Voltage terminal.
- 3 Plug the sense lead into the Sense (+) terminal and the high current test lead into the Current terminal. These two red leads act as the high current output.
- 4 Plug the power cord of the DUT into the adapter box receptacle.

**WARNING: DO NOT TOUCH THE DEVICE UNDER TEST ONCE YOU START THE TEST.**

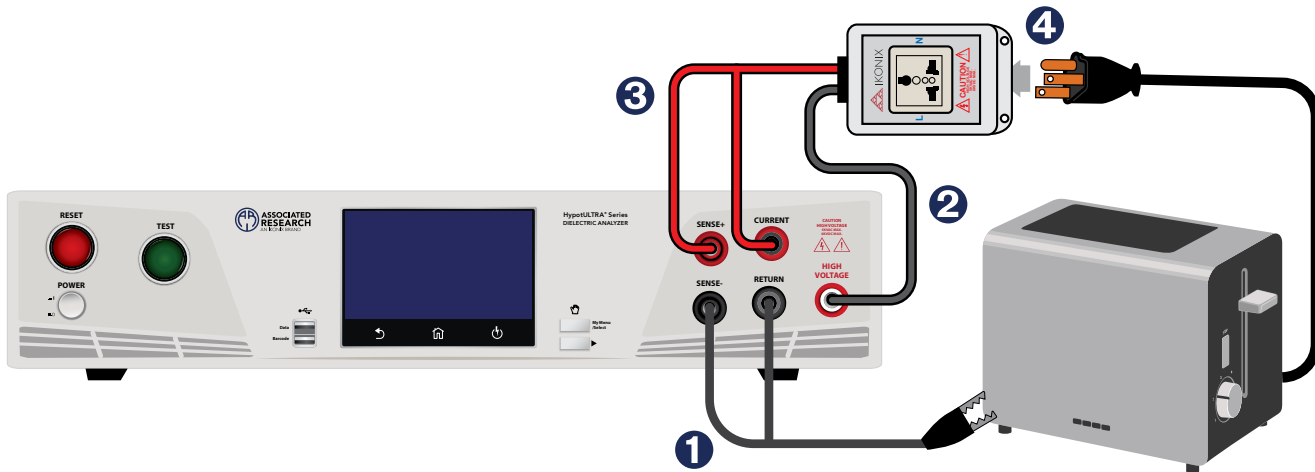

## Adapter Box Connections (7820, 7850, and 7800)

The adapter box provides an easy way to connect the HypotULTRA to a device under test (DUT) terminated in a two- or three-prong power cord. The following diagram shows how to connect the adapter box to the HypotULTRA to the DUT.

If you need to perform a Ground Continuity test, be sure you enable the Ground Continuity test type before moving forward.

- 1 Plug the black cord from the adapter box (P/N 36544) into the continuity output terminal located on the front panel.
- 2 Plug the white cord from the adapter box into the high voltage output terminal located on the front panel.
- 3 Connect the black ground return lead (P/N 2100A-13) to the front panel return output terminal and connect the other end of the lead to the dead metal on the chassis of the DUT. Always check to be sure a good connection has been made between the DUT and the return clip.
- 4 Plug the line cord of the DUT into the adapter box receptacle.

You may also use the rear output terminals on the back of the HypotULTRA instead of the front panel output terminals.

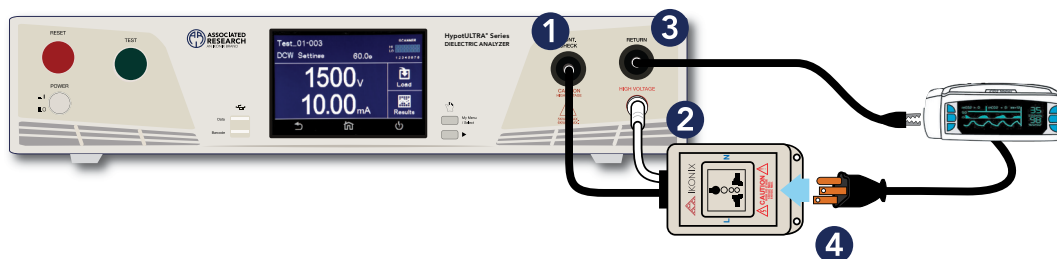

## Manual Voltage Adjustment

When HypotULTRA is performing a test, "+" and "-" icons will appear on touch screen. These icons may be used to adjust the output voltage while performing a test.



Pressing the "+" icon will increase the output voltage and pressing the "-" icon will decrease the output voltage. Manual voltage adjustment temporarily overrides the voltage setting and only remains in effect until the test is terminated by Pass, Fail, or Abort conditions. When Security feature is ON, manual voltage adjustment is disabled for users with limited access. You will not see the "+" and "-" soft key selections in this case.

## Failure Modes

Failure Message	Test Type	Description
<b>Abort</b>	All	This message appears on the display if you abort the test in process with the RESET button, PLC Reset or Opening Interlock Signal.
<b>HI-Limit</b>	GND, ACW, DCW, IR	This message appears on the display if the DUT measurement exceeds the HI-Limit setting of any parameter.
<b>LO-Limit</b>	GND, ACW, DCW, IR	This message appears on the display if the DUT measurement drops below the LO-Limit.
<b>Max-Lmt</b>	Continuity	This message appears on the display if the DUT measurement exceeds the Max-Lmt setting of any parameter.
<b>Min-Lmt</b>	Continuity	This message appears on the display if the DUT measurement drops below the Min-Lmt.
<b>CONT-Fail</b>	ACW, DCW	This message appears on the display if the DUT fails the basic continuity check performed during an AC/DC Withstand test (if Continuity is selected "ON").
<b>Arc-Fail</b>	ACW, DCW	This message appears on the display if the DUT arcing current exceeds the Arc Sense limit and Arc function is active (Arc Sense = 1..9) of the AC/DC Withstand test.
<b>Short</b>	ACW, DCW, IR	This message appears on the display if the DUT current is well beyond the metering range of the test.
<b>Charge-LO</b>	DCW, IR	This message appears on the display if the leakage current during Ramp-up falls below the Charge -LO setting.
<b>Breakdown</b>	ACW, DCW	This message appears on the display if the DUT current is well beyond the metering range of the test and the arcing condition beyond the arc sense limit.
<b>GND-Fault</b>	ACW, DCW	This message appears on the display if the SmartGFI threshold is exceeded during the test.
<b>Interlock Open</b>	All	This message appears on the display if the Remote Interlock feature is activated before or during a test. The Remote Interlock feature utilizes a set of closed contacts which will disable the instrument's output if they are opened before or during a test. You can also refer to the Remote Interlock as a remote system lockout, utilizing "fail when open" logic. You can disable the Remote Interlock feature by plugging the "Interlock Disable Key" provided into the Signal Input connector.
<b>Ramp-Hi</b>	DCW	This message appears on the display when the Ramp-Hi limit is exceeded during the test.

## Error Messages

**Output Error:** This message appears on the display if the instruments output reading does not match the setting. If the instrument has an output problem when the TEST button is pressed, the Output Error screen will appear as follows:



The RESET button is not active in this situation. Only the EXIT button will allow you to return to the Perform Test screen.

**Voltage at Return:** The HypotULTRA contains a protective circuit on the Return port. This circuit has the capability to protect the instrument from getting damaged as result of line voltage coming back into the Return circuit. If the instrument detects any line voltage on the Return circuit then the following screen will appear:

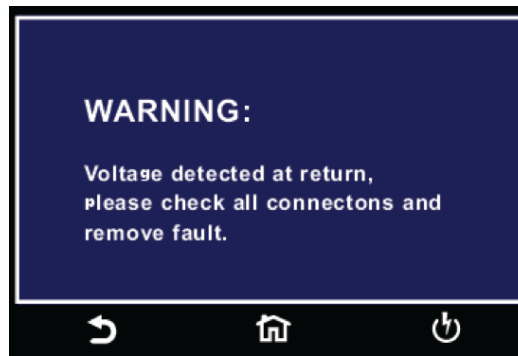

Check for any inappropriate connections to the Return line.  
The message will auto reset after built-in timer.

## Fatal Error

If the instrument has a recognizable internal corruption and the TEST button is pressed, a Fatal Error screen will appear. This type of failure permanently locks the instrument in the "Fatal Error" mode and requires that the instrument be serviced by Associated Research. Press "EXIT" on the touch screen to return to previous menu.

The following Fatal Error identification numbers will represent the type of failure that has occurred:

**Error Code 9002** will appear on the display if the instrument's System Data or the Model/Option/Serial Number Data are corrupted and do not match the settings.

**Error Code 9003** will appear on the display if the instrument's Calibration Data is corrupted.

**OTP** message will appear on the display if the instrument has overheated.

## Low or Dead Battery

The HypotULTRA contains internal battery to keep system data and time. The following message will appear on the screen once the battery voltage level falls below described value.

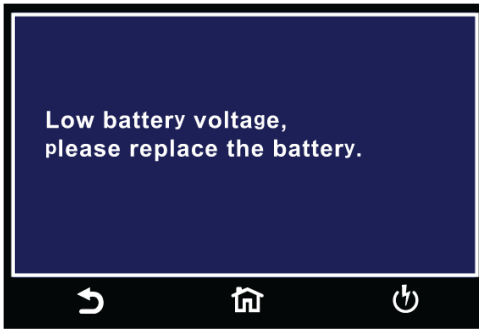

### Battery voltage below 2 Volts

*Note:* The message will appear on the screen when the internal battery voltage falls below 2 Volts. It is recommended to replace the battery during your next calibration or service request.

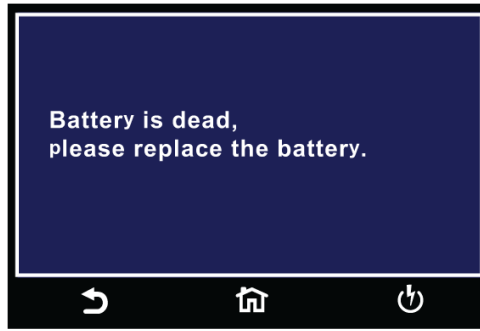

### Battery voltage below 0.5 Volts.

*Note:* When the internal clock battery dies the timestamping of results data may become corrupted. The instrument's testing capabilities are not affected by dead battery. After this message appears, the instrument will store the last known data and time for results data.

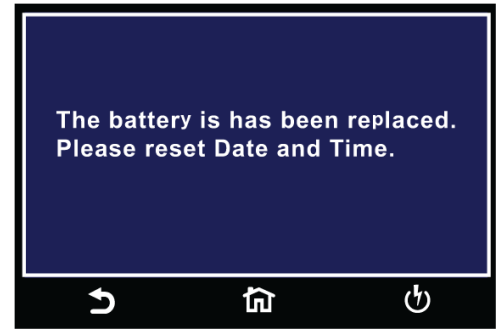

### After replacing a new battery.

*Note:* Update the System Date and Time after replacing the battery.

## Meters

The Perform Test screen of the HypotULTRA has several different meters depending on the type of test you are performing. You can arrange these meters as desired. You can also tie these meters to the user security setup. The drag and drop feature of the instrument allows you to set large and small meters. For example the following screen shot shows the Perform Test screen of the DCW test:

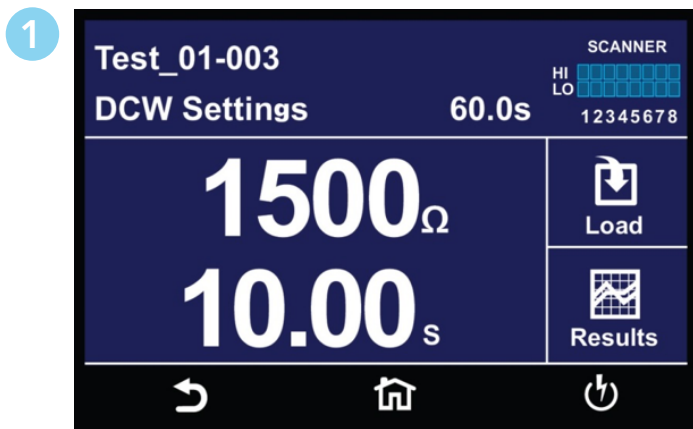

In the image above, the two large meters display the DCW test voltage and the Dwell Time.

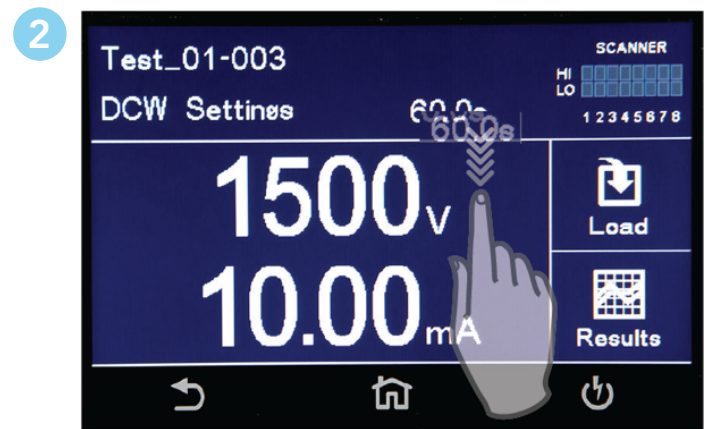

Touch and hold the display on any of the meters and drag it on to the location of a different meter and the two meters will be swapped.

## Viewing Test Results

After a test has completed the Results icon will be available on the screen. For example:

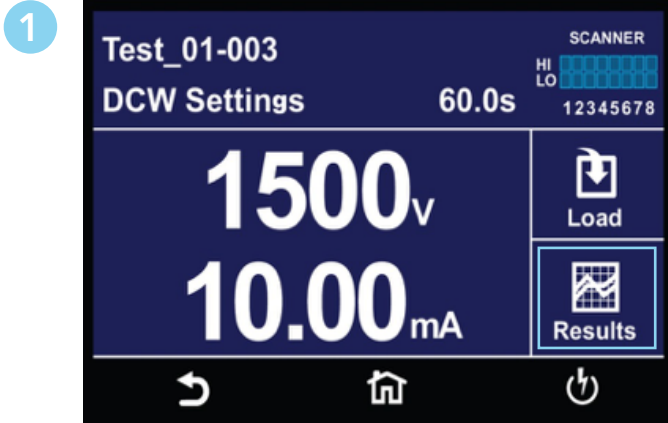

Select the Results icon to enter the results screen.

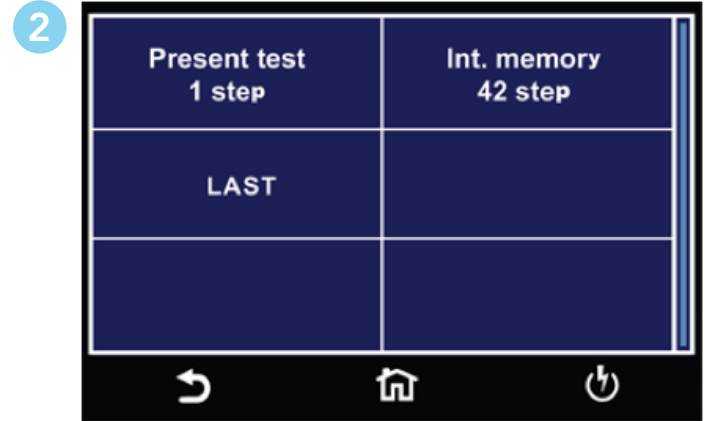

The Results screen will appear. The Results screen allows you to view the results of the last test step the instrument performed and the results of the previously performed tests.

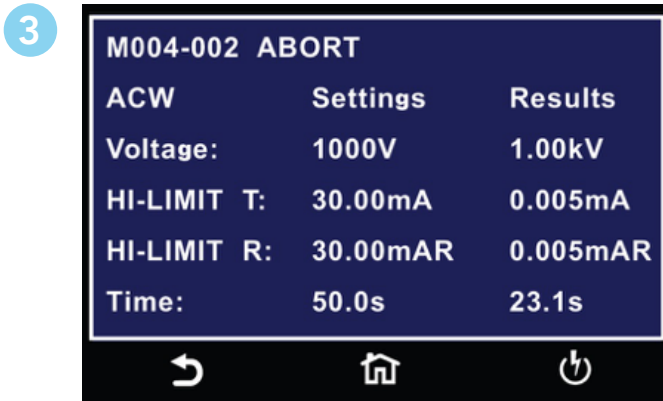

Select Present Test to view test results from the current test sequence that was executed. Select any test step to view more details regarding the test.

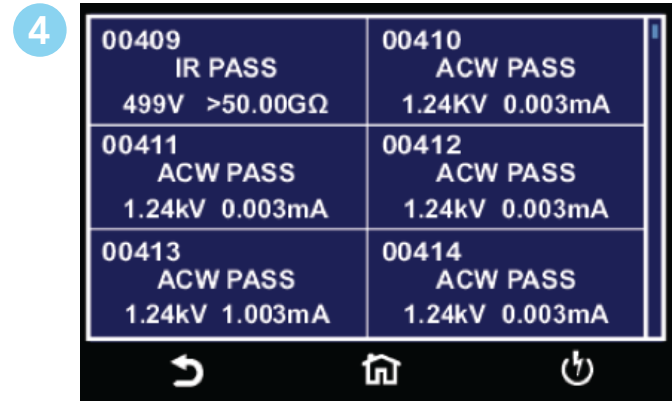

Select Int. Memory to view all the test results stored on the internal memory of the instrument. Scroll down to view all the test results.

## Transfer Test Results

Touch and hold any test step result on the previous screen and a new screen will pop up:

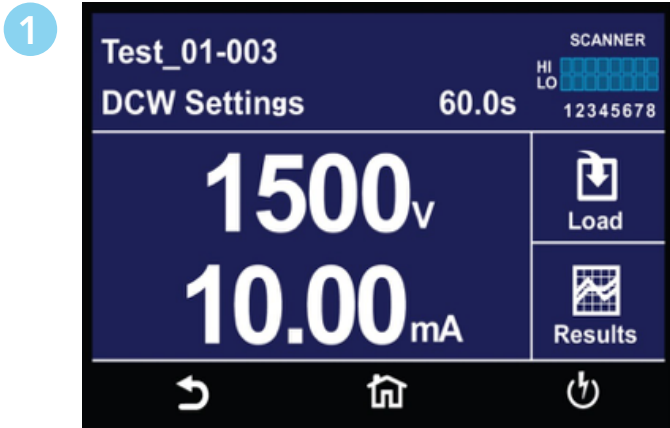

Perform Test Screen.

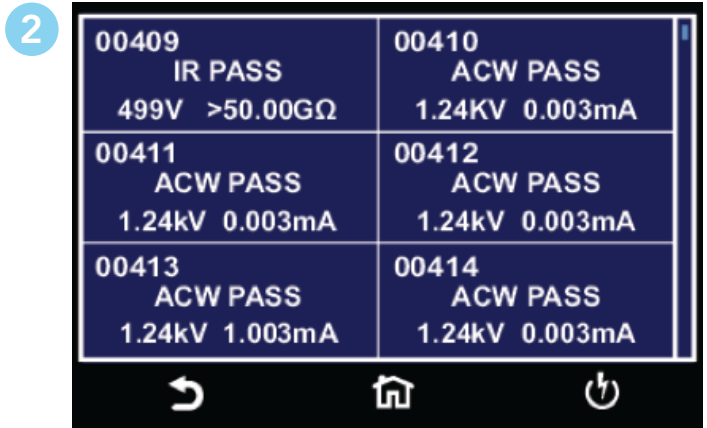

Tap Results icon.

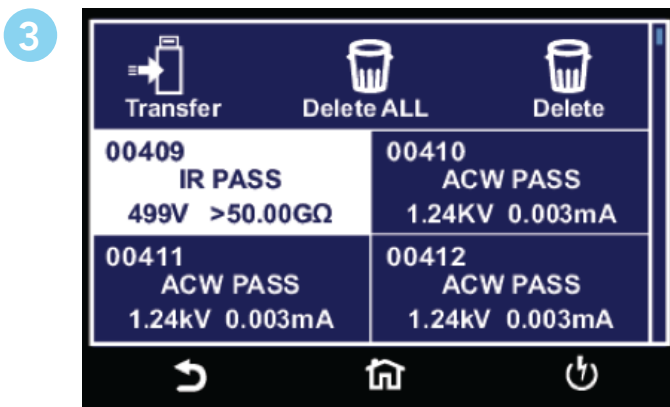

Select Result(s) to transfer or delete.

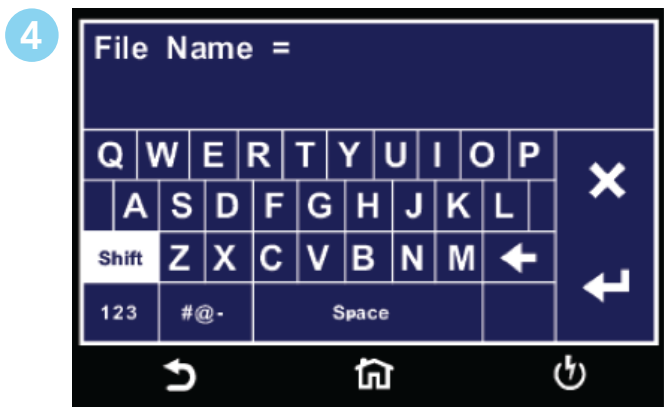

Enter name for Results File.

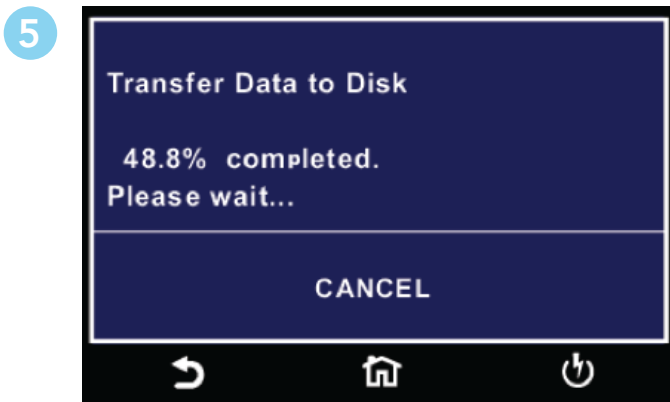

Transfer results progress.

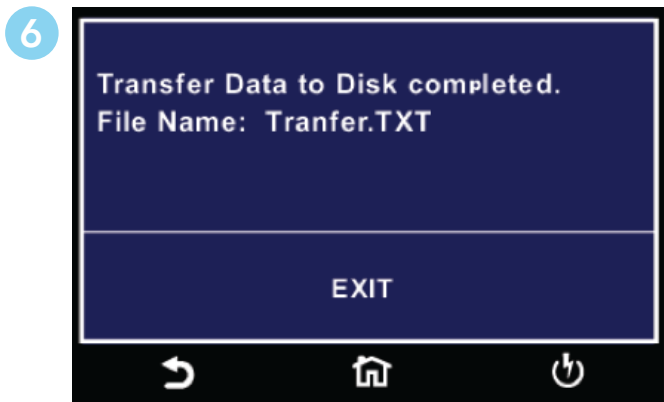

Transfer results complete.

From this screen you can transfer All results to a USB disk, delete All results or delete a single result. Selecting Delete ALL will delete all the test results from the internal memory. Selecting delete will delete a selected step.

To transfer results to a USB disk select the Transfer icon and a new pop up screen will appear where a file name must be entered for the results file. The results will be saved on the USB disk.

Once the results file transfer is complete a message will appear on the screen confirming the successful transfer along with the results file name that was previously assigned.



# 4. Security

Instrument security and user setup screen. The first option under Security allows you to set Security to ON or OFF.

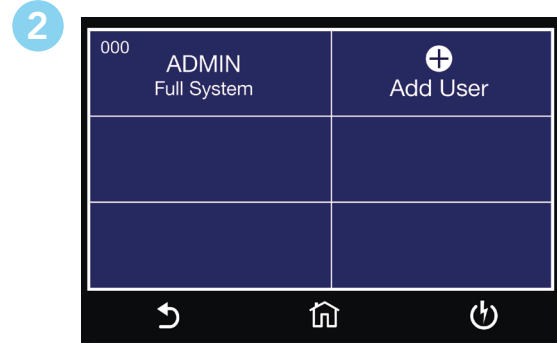
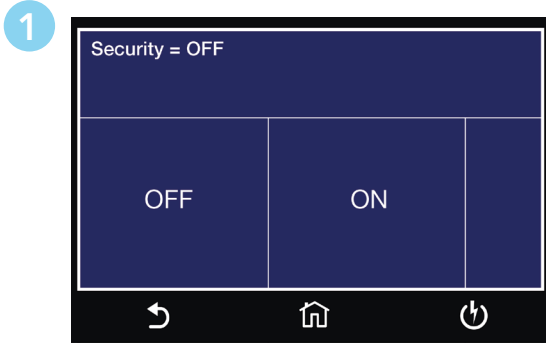
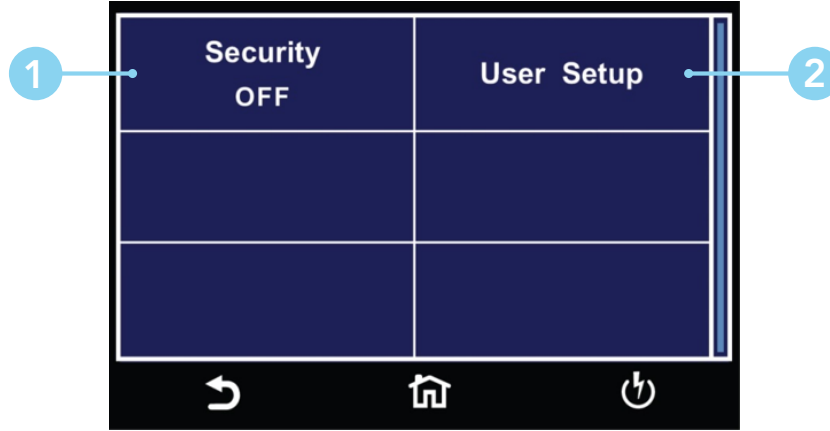

## User Setup

The next option under security is User Setup where multiple users can be added and assigned different privileges.

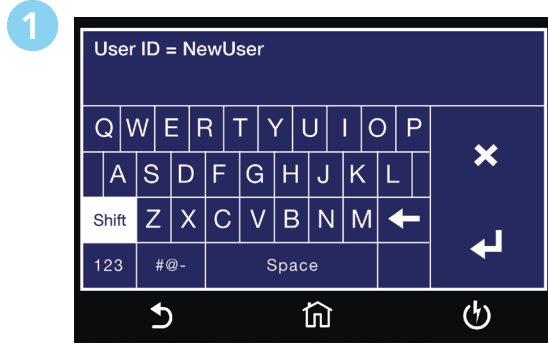

Enter New User ID.

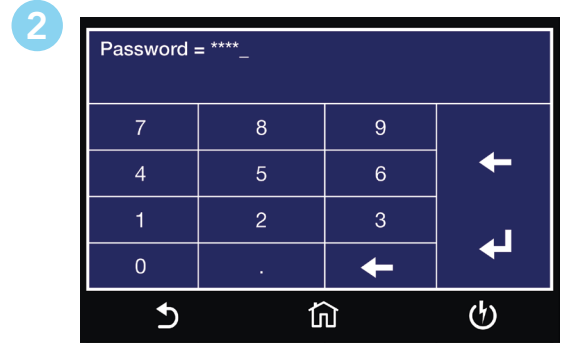

Enter Password.

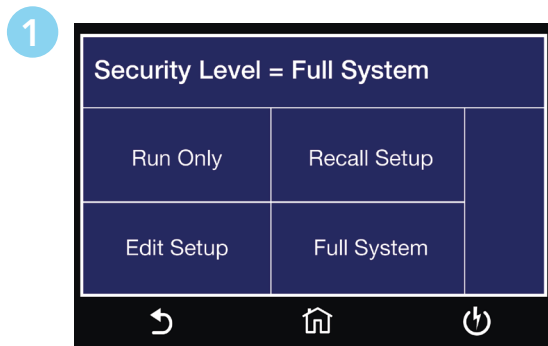

Select Security Level.

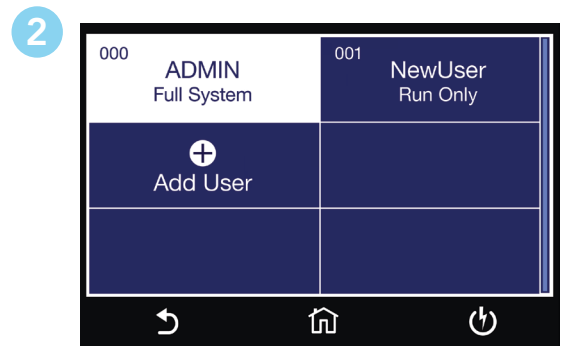

User Setup Menu updated.

Security Level	Description
<b>Full System</b>	In this mode you have full access level to all instrument setup parameters as well as system configuration and security levels. Access at this level should be restricted to System Administrators.
<b>Edit Setup</b>	In this mode you can load files and edit test parameters.
<b>Recall Setup</b>	This mode allows you to load previously configured test files but it does not allow any editing of the parameters. In this mode you are restricted from access to the "Setup Test Parameters" screen.
<b>Run Only</b>	This is the most restricted mode of user access. You can only initiate a test, reset a failure or abort a test from the Perform Tests screen.  <b>NOTE:</b> whenever your security level is Run Only, you may only start at test step 1.

### Security – Forgotten Password

If you have forgotten your password you may access all security functions by typing in the number "8000" into the password field. The old password cannot be recovered and a new password needs to be entered.

## 5. FailCHEK

FAILCHEK is the process by which an instrument's failure detectors are proven to be functioning properly. Safety agencies such as CSA, UL and TÜV require checking the failure detection circuitry of the electrical safety instrument. To perform FAILCHEK touch the test icon and follow instructions on the instrument screen.

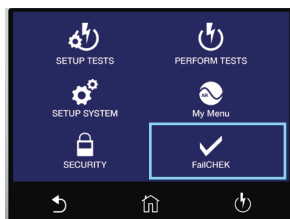

Main Menu

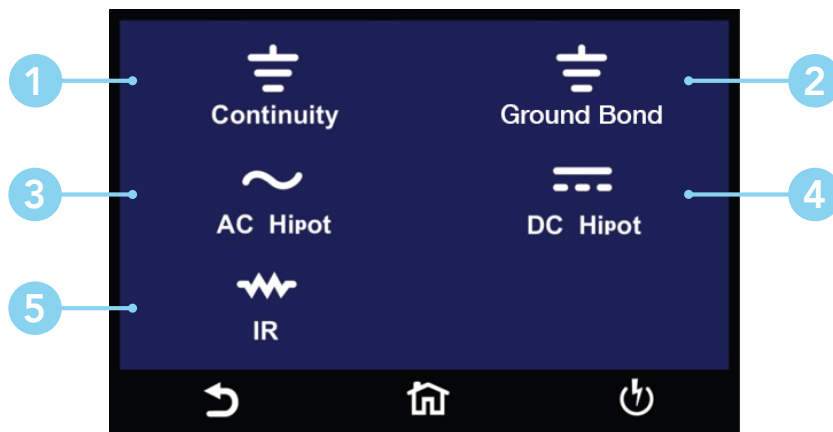

FailCHEK Menu

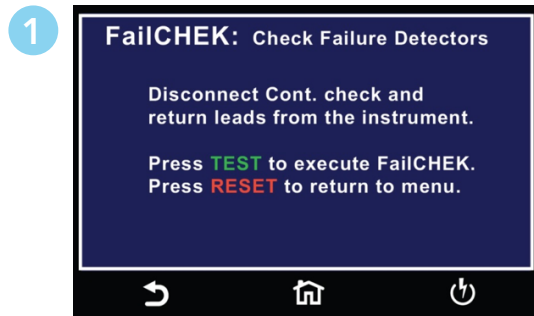

Continuity FailCHEK screen

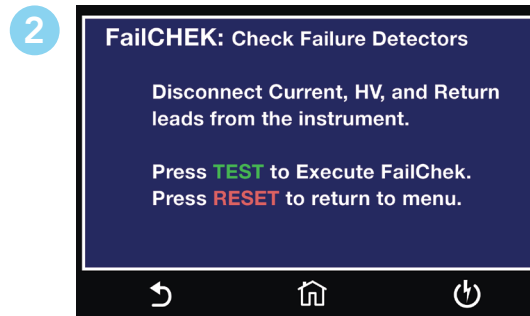

Ground Bond FailCHEK screen

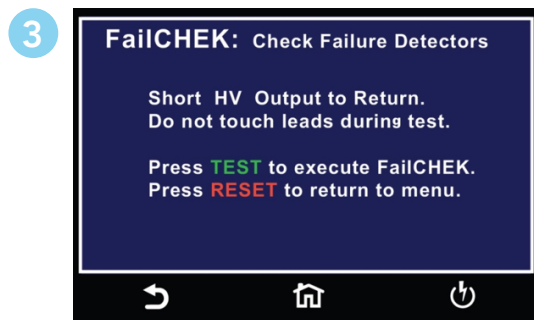

AC Hipot FailCHEK screen

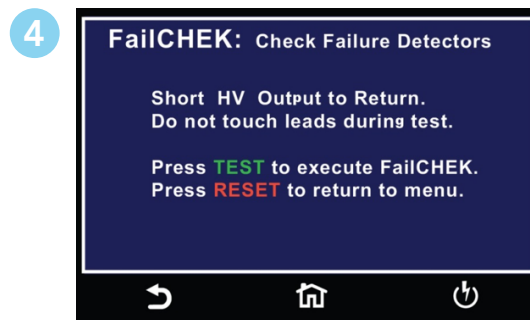

DC Hipot FailCHEK screen

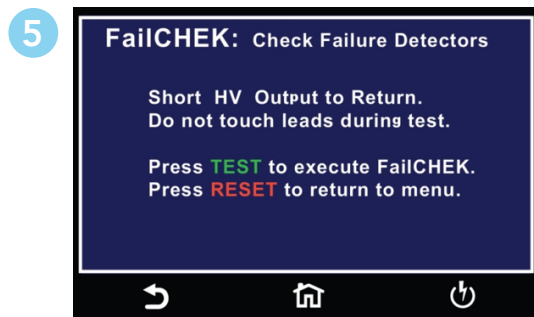

IR FailCHEK screen

## FailCHEK Continuity

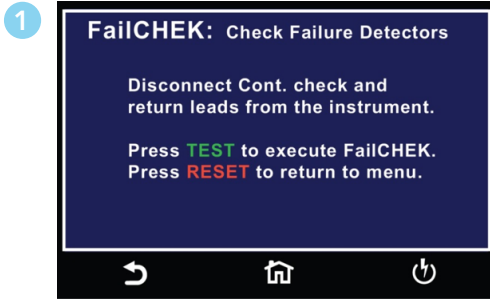

To perform Continuity FailCHEK follow on-screen instructions.



Continuity Fail Detectors OK screen.

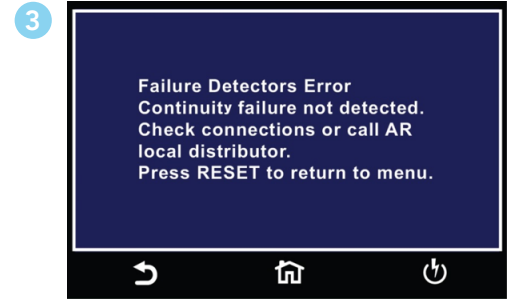

Continuity Fail Detectors ERROR screen.

## FailCHEK Ground Bond

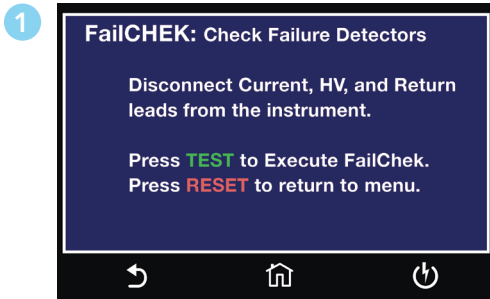

To perform Continuity FailCHEK follow on-screen instructions.

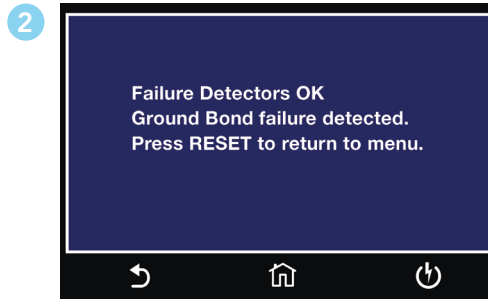

Ground Bond Fail Detectors OK screen.

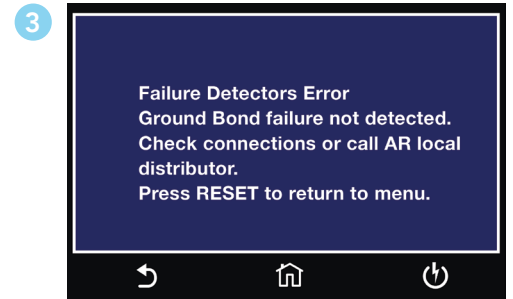

Ground Bond Fail Detectors ERROR screen.

## FailCHEK AC Hipot

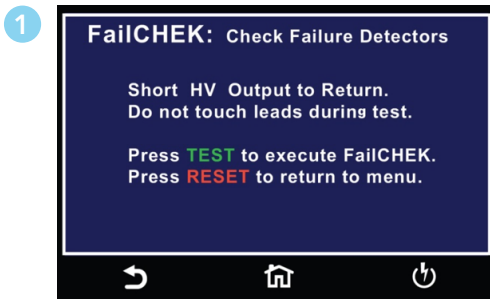

To perform AC Hipot FailCHEK follow on screen instructions.

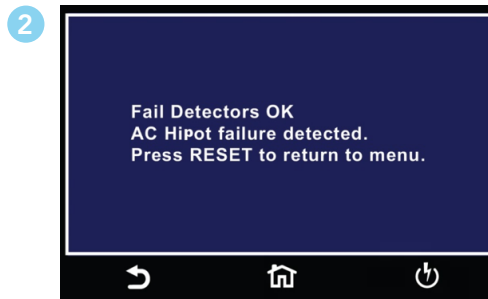

AC Hipot Fail Detectors OK screen.

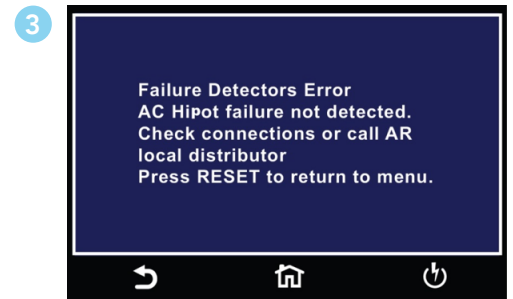

AC Hipot Fail Detectors ERROR screen.

## FailCHEK DC Hipot

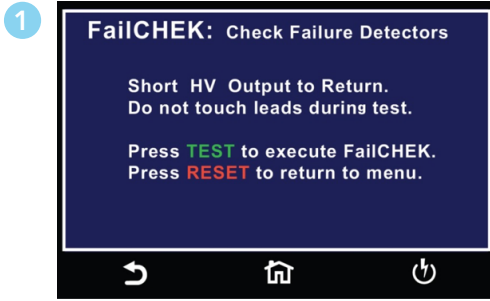

To perform DC Hipot FailCHEK follow on screen instructions and press Green TEST Button or Red RESET to return to previous menu.

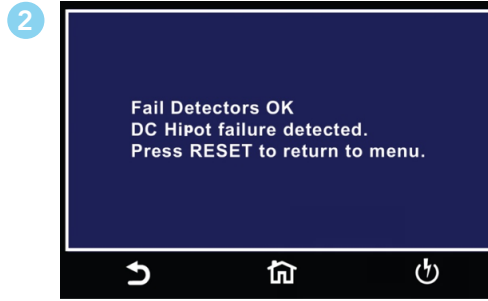

DC Hipot Fail Detectors OK screen.

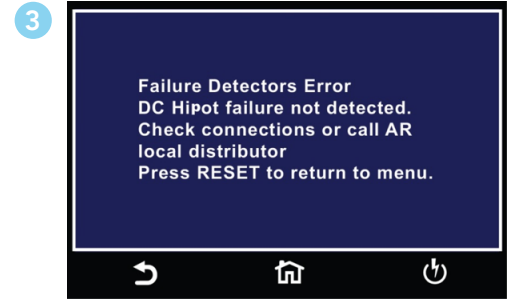

DC Hipot Fail Detectors ERROR screen.

## FailCHEK Insulation Resistance

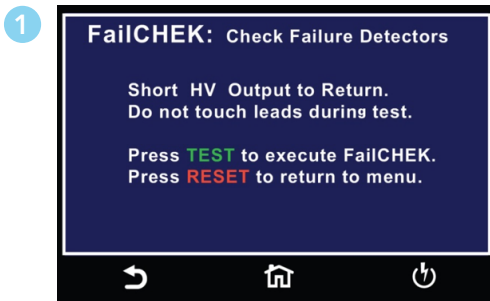

To perform IR Hipot FailCHEK follow on screen instructions and press Green TEST Button or Red RESET to return to previous menu.

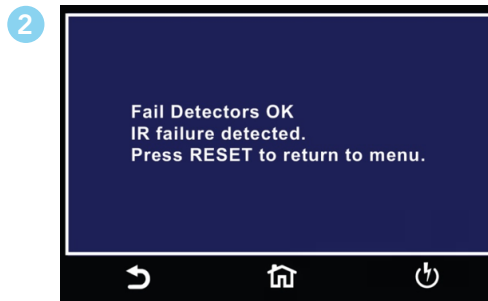

IR Fail Detectors OK screen.

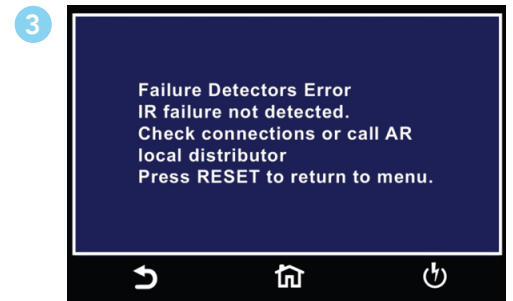

IR Fail Detectors ERROR screen.

## 6. MyMenu

The MyMenu function allows the user to configure a custom menu. User can store the desired test files under MyMenu and access the files with a single touch.



Main Menu



Select Add New to add test file to MyMenu



Select file to be added to MyMenu.

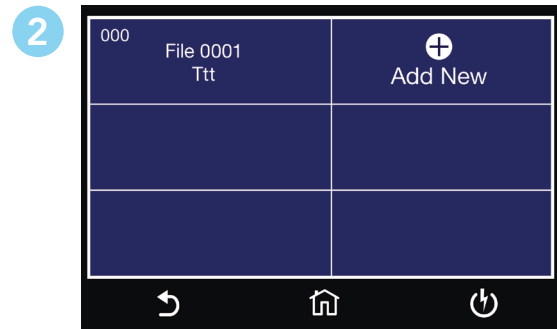

MyMenu Screen.

# Using Remote I/O and PLC Control

Two 9-pin "D" type connectors mounted on the rear panel provide REMOTE-INPUT-OUTPUT control and information.

- These connectors mate with a standard 9 pin D-sub-miniature connector provided by the user.
- The output mates to a male (plug) connector while the input mates to a female (receptacle) connector.
- For best performance, you should use a shielded cable. To avoid ground loops you should not ground the shield at both ends of the cable.

## Suggested AMP part numbers for interconnecting to the Remote I/O

Part Number	Description
205204-4	Plug shell with ground indents
205203-3	Receptacle shell
745254-7	Crimp snap-in pin contact (for plug)
745253-7	Crimp snap-in socket contact (for receptacle)
745171-1	Shielded cable clamp (for either plug or receptacle)
747784-3	Jackscrew set (2)

## Remote I/O Pinouts

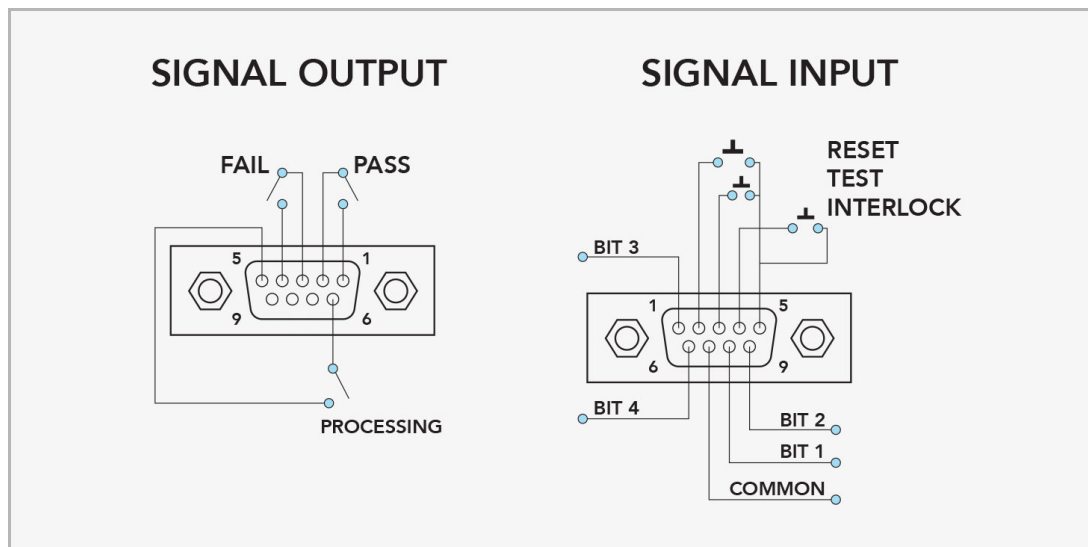

## Signals on Remote I/O

### REMOTE INPUT/OUTPUT

<b>Remote Output</b>		<b>The rear panel connector provides three output signals to remotely monitor PASS, FAIL, and PROCESSING conditions. The monitoring signals are provided by three normally open internal relays that toggle ON and OFF to indicate the condition of the instrument. These are normally open free contacts and will not provide any voltage or current.</b>
Output Signal	Pins	Description
PASS	1 and 2	The relay contact closes after detecting that the device under test passed all tests. The connection is opened when the next test is initiated or the reset function is activated.
FAIL	3 and 4	The relay contact closes after detecting that the device under test failed any test. The connection is opened when the next test is initiated or the reset function activated.
PROCESSING	5 and 6	The relay contact closes while the tester is performing a test. The connection is opened at the end of the test.

*These are normally open free contacts and will not provide any voltage or current. The ratings of the contacts are 1 AAC / 125 VAC (0.5 ADC / 30 VDC). When a terminal becomes active, the relay closes thereby allowing the external voltage to operate an external device.*

<b>Remote Input</b>		<b>The HypotULTRA remote connector enables remote operation of the TEST, RESET, and REMOTE INTERLOCK functions, and allows you to select one of 10 pre-programmed test files.</b>
Output Signal	Pins	Description
TEST	3 and 5	A normally open momentary switch can be wired across pins 3 and 5 to allow remote operation of the TEST function. A minimum pulse width or contact closure of 20mS is required to guarantee a test start.
RESET	2 and 5	A normally open momentary switch can be wired across pins 2 and 5 to allow remote operation of the RESET function. For safety, the front panel RESET button remains active even when a remote reset switch is connected so that high voltage can be shut down from either location. A minimum pulse width or contact closure of 50mS is required to guarantee that a running test will abort.
INTERLOCK	4 and 5	<p>Remote Interlock utilizes a set of closed contacts to enable the tester's output. The output of the tester will be disabled under the following conditions:</p> <ul style="list-style-type: none"> <li>• If the Interlock contacts are open and the TEST button is pushed.</li> <li>• If the interlock contacts are opened during a test (test will automatically abort).</li> </ul> <p>A pop-up message will be displayed on the screen:</p>  <p>The tester can still be used without the external interlock device as long as the Interlock Connector (P/N # 38075 provided with unit) is plugged into the Remote Interface, Signal Input port. If there is nothing connected to the Remote Interface, Signal Input port to provide a connection to the interlock, the tester will not perform tests.</p>

*When the PLC Remote mode is ON, the tester will respond to simple switch or relay contacts closures. When the PLC Remote function is ON the TEST button on the front panel will be disabled.*



## Remote Signal Inputs and File Access

- The Remote File Select function gives you the capability to quickly select and initiate a test remotely.
- You can access first ten (10) pre-programmed test files by connecting pins 1, 6, 8 and 9 to the common pin 7, in different combinations.
- The memory select bits should be set simultaneously and remain set for a minimum of 20ms to guarantee the correct test file will be selected.
- The memory select bits may be set in sequential manner, provided that the time delay between each bit is less than 4ms.
- When the desired bit pattern has been established it should remain set for a minimum of 20ms to guarantee that the correct memory will be selected.
- It may be necessary to "OR" the momentary switches (relay contacts) to prevent incorrect program selection due to timing errors.

### DID YOU KNOW...

The Remote Signal Input connector may be used with various accessories, including light curtains, foot switches, and safety probes. Contact Associated Research for more information.

REMOTE FILE SELECT TRUTH TABLE

BIT 4	BIT 3	BIT 2	BIT 1	FILE #
0	0	0	1	01
0	0	1	0	02
0	0	1	1	03
0	1	0	0	04
0	1	0	1	05
0	1	1	0	06
0	1	1	1	07
1	0	0	0	08
1	0	0	1	09
1	0	1	0	10

1= Momentary Contact closure between BIT and COMMON  
0= No Contact closure between BIT and COMMON

### WARNING

Activating remote file select functions through the remote connector, selects and runs the test which is preprogrammed into that file location.

Activation des fonctions de mémoire programme via le connecteur remote, sélectionne le programme et lance le test qui est préprogrammé dans cette mémoire.

### CAUTION

Do not connect voltage or current to the signal inputs, this could result in damage to the control circuitry.

Ne pas connecter tension ou de courant aux entrées de signal, cela pourrait provoquer des dommages au circuit de contrôle.

# Appendix A - Installation and Test Operator Information

## Installation

### 1. Unpacking and Inspection

Your instrument ships in a custom foam insulated container. If the shipping carton is damaged, inspect the contents for visible damage such as dents, scratches or a broken display. If the instrument is damaged, notify the carrier and Associated Research's customer care department. Please save the shipping carton and packing material for the carrier's inspection. Our customer care department will assist you in the repair or replacement of your instrument. Please do not return your product without first notifying us and receiving an RMA (return material authorization) number. To receive an RMA number, please contact our customer care department at **1-800-858-TEST (8378)**.

### 2. Safe Lifting and Carrying Instructions

Proper methods of lifting and carrying can help to protect against injury. Follow the recommendations below to ensure that instruments are handled in a safe manner.

- Determine if the instrument can be lifted by one individual or requires additional support.
- Make sure that your balance is centered and your feet are properly spaced, shoulder width apart behind the instrument.
- Bend at the knees and make sure your back is straight.
- Grip the instrument with your fingers and palms and do not lift unless your back is straight.
- Lift up with your legs, not your back.
- Keep the instrument close to your body while carrying.
- Lower the instrument by bending your knees. Keep you back straight.

### 3. Contents of the Carton

DESCRIPTION	AR PART NUMBER	DESCRIPTION	AR PART NUMBER
<b>HypotULTRA® Instrument</b>	<b>7820, 7850, 7800</b>	<b>HypotULTRA® Instrument</b>	<b>7804, 7854</b>
High Voltage Cable	04040A-08	High Voltage Cable	04040A-08
Return Cable	02100A-13 (Qty.2)	High Current Output Cable	38489
USB Cable AB-Type 1.8m	39066	High Current Return Cable	38490
Fuse	37780 (7804/7820/7850) 37999 (7800/7854)	Fuse	37780 (7804/7820/7850) 37999 (7800/7854)
Line Cord*	33189 Standard	USB Cable AB-Type 1.8m	39066
Adapter Box*	36544 Standard	Line Cord*	33189 Standard
2U Rack Mount Handle (Qty 2)	38794	Adapter Box*	38482 Standard
2U Rack Mount Bracket (Qty 2)	38793	Interlock Connector	38075
Screw M4 x 12mm FHMS (Qty 4)	38549 For Rack Mount Handle	2U Rack Mount Handle (Qty 2)	38794
Interlock Connector	38075	2U Rack Mount Bracket (Qty 2)	38793
8GB USB Flash Drive	39571	Screw M4 x 12mm FHMS (Qty 4)	38549 For Rack Mount Handle

\*The Line Cord listed is American. Other combinations of the Line Cord are available upon request.

## WARNING

Use only accessories that meet the manufacturer's specification.

Utiliser uniquement des accessoires conformes aux spécifications du fabricant.

## 4. Preparation for Use

### Power Requirements

This instrument requires a power source of either 115 volts AC  $\pm$  10%, 50/60 Hz single phase or 230 volts AC  $\pm$ 10%, 50/60 Hz single phase. See section for Rear Panel Controls for an image of the rear panel.

## CAUTION

Do not replace the power supply cord with an improperly rated cord. For North American: A UL listed and CSA labeled power cord must be used with the instrument in the United States and Canada. The power cord must include a NEMA5-15 style male plug, SVT or SJT cord sets, and be rated for at least 125VAC, 10A, number 16 gauge (or 125VAC, 15A, number 14 gauge) wire or larger, and the length of the cord does not exceed 2 m must be used. For European: A certified power supply cord not lighter than light PVC sheathed flexible cord according to IEC 60227, designation H03 VV-F or H03 VVH2-F (for equipment mass not exceeding 3 kg), or H05 VV-F or H05 VVH2-F2 (for equipment mass exceeding 3 kg), and be rated for at least 3G 0.75 mm<sup>2</sup> (for rated current up to 10 A) or 3G 1.0mm<sup>2</sup> (for rated current over 10 A up to 16 A) wire or larger, and the length of the cord does not exceed 2 m must be used.

Ne remplacez pas le cordon d'alimentation avec un cordon mal classé . Pour l'Amérique du Nord: Une UL et CSA marqué cordon d'alimentation doit être olariz avec l'instrument aux États-Unis et Canada . Le cordon d'alimentation doit comporter une fiche mâle NEMA5-15 de style , SVT ou ensembles SJT de la moelle , et être classé pendant au moins 125VAC , 10<sup>a</sup> , numéro de calibre 16 ( ou 125VAC , 15<sup>a</sup> , numéro de calibre 14 ) fil ou plus, et la longueur de le cordon ne dépasse pas 2 m doit être utilisé . Pour européenne : Un cordon d 'alimentation certifié , pas plus léger que le PVC lumière câbles souples sous gaine selon la norme IEC 60227 , la désignation H03 VV- F ou H03 VVH2 – F ( pour la masse de l'équipement ne dépassant pas 3 kg ) , ou H05 VV- F ou H05 VVH2 – F2 (masse d' équipement de plus de 3 kg) , et être prévus pour au moins 3G 0,75 mm <sup>2</sup> ( pour courant nominal jusqu'à 10 A ) ou 3G 1.0mm<sup>2</sup> ( pour fil nominale ou plus actuelle plus de 10 A à 16 A ) , et la longueur du cordon ne doit pas excéder 2 m doit être utilisé.

## WARNING

The HypotULTRA must be connected to a good ground. Be certain that the power wiring is properly polarized and the proper low resistance bonding to ground is in place.

L'HypotULTRA doit être relié à un bon sol. Assurez-vous que le câblage d'alimentation est correctement polarisé et que la bonne résistance à la terre est en place.

## 5. Power Cable

The instrument is shipped with a line cord containing a protective earth ground. When the line cord is connected to an appropriate AC power source the cable will connect the chassis to earth ground.

## WARNING

Only insert the main plug in a socket outlet with a protective ground (earth) contact. This protective ground must not be defeated by the use of an extension cord without a protective conductor.

La fiche principale ne doit être insérée dans une prise de courant avec une masse (terre ) avec système de protection . Cette terre de protection ne doit pas être vaincu par l'utilisation d' une rallonge sans conducteur de protection.

This instrument is shipped with a three-wire power cable. When this cable is connected to an appropriate AC power source, this cable connects the chassis to earth ground. The type of power cable shipped with each instrument depends on the country of destination.

## Operating Environment

This equipment is intended for indoor use only. The equipment has been evaluated according to Installation Category II and Pollution Degree 2 as specified in IEC 664.

Operate this instrument in environments with the following limits:

Temperature ..... 41° - 104° F (5° - 40°C)

Relative humidity ..... 0 – 80%

Altitude ..... 6560 feet (2,000 meters)

### WARNING

Do not block any ventilation openings to prevent over heating of the equipment. Keep the ventilation slits uncovered during operation. Failure to do so could cause the instrument to overheat and may damage internal components.

Ne pas bloquer les ouvertures de ventilation pour éviter la surchauffe de l'équipement. Gardez les fentes de ventilation découvertes au cours de l'opération. Ne pas le faire pourrait entraîner l'instrument de surchauffer et endommager les composants internes.

## Storage and Shipment

Store or ship this instrument in environments with the following limits:

Temperature ..... -40° - 167° F (-40° - 75°C)

Altitude ..... 50,000 feet (15,240 meters)

Also protect this instrument against temperature extremes that may cause condensation within the instrument.

### CAUTION

Failure to operate this instrument within the specified conditions could result in damage.

L'incapacité à manipuler cet instrument dans les conditions spécifiées peuvent entraîner des dommages.

If the instrument is used in a manner not specified by the manufacturer, the protection provided by the instrument may be impaired.

### More Information

For more information on test operator and workstation safety please visit the Events and Training section of our website at [www.arisafety.com](http://www.arisafety.com)

## Test Operator and Safety Considerations

### 1. Qualifications

### WARNING

This instrument generates voltages and currents that can cause harmful or fatal electric shock and must only be operated by a skilled worker trained in its use. The operator should understand the electrical fundamentals of voltage, current, and resistance.

Cet instrument produit des tensions et des courants qui peuvent causer des chocs électriques dangereux ou mortel et ne doivent être exploitées par un travailleur qualifié formé à son olarize ve . L'opérateur doit comprendre les principes fondamentaux électriques de tension, courant et la résistance.

### WARNING

Do not touch the device under test, high voltage test lead, alligator clip, or clip insulator once the test has been started.

Ne touchez pas l'appareil sous test, le fil de test haute tension, le crocodile ou l'isolateur de clip une fois le test lancé.

## WARNING

Do not touch the front panel when testing or after a malfunction has occurred.

Ne olariz pas la face avant lors de l'essai ou après un dysfonctionnement s'est produit.

*The operator should understand the electrical fundamentals of voltage, current, and resistance.*

## 2. Safety Procedures

Operators should be thoroughly trained to follow these and all other applicable safety rules and procedures before they begin a test. Defeating any safety system should be treated as a serious offense and should result in severe penalties, such as removal from the Hipot testing job. Allowing unauthorized personnel in the area during a test should also be dealt with as a serious offense.

Refer to the following standards for more information:

- NFPA 70E
- OSHA 1910 subpart (S)
- EN50191

## 3. Dress

### WARNING

Operators should not wear jewelry that could accidentally complete a circuit.

Do not observe ESD protocols while performing electrical safety tests. Intentionally grounding the test operator could lead to a harmful or fatal electric shock.

Protocoles de l'EDD ne devraient pas être respectés lors de l'exécution des tests de sécurité électrique. Intentionnellement à la terre à l'opérateur de test pourrait conduire à un choc électrique dangereux ou mortel.

## 4. Medical Restrictions

Inform personnel with heart ailments or devices such as pacemakers, the voltages and currents generated by the instrument are very dangerous. If contacted, the instrument may cause heart-related problems. Please have the test operator consult a physician for recommendations.

## 5. Test Station

### Location

Select an area away from the main stream of activity which employees do not walk through in performing their normal duties. If this is not practical because of production line flow, then the area should be roped off and marked for HIGH VOLTAGE TESTING. No employees other than the test operators should be allowed inside. If benches are placed back-to-back, be especially careful about the use of the bench opposite the test station. Signs should be posted: "DANGER - HIGH VOLTAGE TEST IN PROGRESS - UNAUTHORIZED PERSONNEL KEEP AWAY."

### WARNING

The mains plug is used as the disconnecting device and shall remain readily operable. The socket-outlet shall be installed. Near the equipment and shall be easily accessible.

La fiche secteur est utilisée comme dispositif de déconnexion et doit rester facilement opérationnelle. La prise de courant doit être installée. Près de l'équipement et doit être facilement accessible.

## Work Station

Perform the tests on a non-conducting table or workbench, if possible.

There should not be any metal in the work area between the operator and the location where products being tested will be positioned.

Position the instrument so the operator does not have to reach over the product under test to activate or adjust the instrument. If the product or component being tested is small, it may be possible to construct guards or an enclosure, made of a non-conducting material such as clear acrylic, such that the item being tested is within the guards or enclosure during the test, and fit them with switches so that the instrument will not operate unless the guards are in place or the enclosure closed. The outlet which is used to provide power to the instrument should be easily accessible.

Keep the area clean and uncluttered. All test equipment and test leads not absolutely necessary for the test should be removed from the test bench and put away. It should be clear to both the operator and to any observers which product is being tested, and which ones are waiting to be tested or have already been tested. If the instrument is used in a matter not specified by Associated Research the protection provided by the instrument may be impaired.

Do not perform Hipot tests in a combustible atmosphere or in any area where combustible materials are present.

### KEY SAFETY POINTS TO REMEMBER

- Keep unqualified and unauthorized personnel away from the test area.
- Arrange the test station in a safe and orderly manner.
- Never touch the product or connections during a test.
- In case of any problem, turn off the high voltage first.
- Properly discharge any item tested with DC before touching connections.

# Appendix B – Instrument Specifications

## Models 7800, 7804, 7820, 7850 and 7854 Functional Specifications

Unless otherwise stated, accuracy's are relative to a laboratory standard measurement.

INPUT			
Voltage	100 - 120VAC / 200 - 240VAC±10% Auto Range		
Frequency	50/60Hz ± 5%		
Fuse	7804, 7820 and 7850: 6.3A / 250VAC Slow-Blow 7800 and 7854: 15A / 250VAC Fast- Blow		
AC WITHSTAND VOLTAGE (All HypotULTRA Models)			
	Range	Resolution	Accuracy
Output Voltage, AC	0 - 5000	1	± (1.5% of setting + 5V)
Output Frequency	50Hz/60Hz ± 0.1% , User Selection,		
Output Waveform	Sine Wave , Crest Factor = 1.3 - 1.5		
Short Circuit Protection	7804, 7820 and 7850: minimum current 33mA RMS at short circuit, Response time < 2ms 7800 and 7854: Output short Circuit current >200mA		
Output Regulation	± (1% of output + 5V), From no load to full load and Low Line to High Line (combined regulation)		
SETTINGS			
Auto Range			
HI and LO-Limit (Total), current, mA	0.000 - 9.999	0.001	7820, 7850 & 7804: ± (2% of setting + 2 counts)
	10.00 - 40.00 10 - 99.99 (Models 7800 & 7854)	0.01	7800 & 7854: ± (2% of setting + 6 counts)
HI and LO-Limit (Real), current, mA	0.000 - 9.999	0.001	± (3% of setting + 50µA)
	10.00 - 40.00 10 - 99.99 (Models 7800 & 7854)	0.01	
Ramp-Up Timer, second	0.1 - 999.9	0.1	± (0.1% + 0.05 sec)
Ramp-Down Timer, second	0.0 - 999.9		
Dwell Timer, second	0, 0.2 - 999.9 (0=continuous)		
Ground Continuity Current	Current: DC 0.1 A ± 0.01A, fixed		
	Max. Ground Resistance: 1.0 Ω ± 0.1Ω		
Current Offset	7820, 7850 & 7804: 0.000 - 40.00mA (PF=0.00 - 1.00) *(Total current + current offset ≤40.00mA) 7800 & 7854: 0.000 - 100.00mA (PF=0.00 - 1.00) *(Total current + current offset ≤100mA)		
Arc Detection	1 - 9 ranges (9 = highest sensitivity)		

Continued on next page →

Fixed Range			
	Range	Resolution	Accuracy
HI and LO-Limit (Total), current, mA	0.000 - 3.500	0.001	± (2% of setting + 2 counts)
	3.51 - 40.00	0.01	
	3.51 - 99.99	0.01	± (2% of setting + 6 counts)
DC WITHSTAND VOLTAGE (Models 7800, 7804, 7850 and 7854)			
Output Voltage, DC	0 - 6000	1	± (1.5% of setting + 5V)
DC Output Ripple	<4 % (6KV/10mA at Resistive Load)		
Short Circuit Protection	Minimum current 11mA AVG at short circuit, Response time < 2ms		
SETTINGS			
Auto Range			
HI and LO-Limit, current, µA	0.0000 - 0.9999	0.0001	± (2% of setting + 10 counts) Low Range is ON
	1.000 - 9.999	0.001	
	10.00 - 99.99	0.01	
	100.0 - 999.9, Low Range = ON 0.0 - 999.9 Low Range = OFF	0.1	± (2% of setting + 2 counts)
	1000 - 10000 (Models 78X0) 1000 - 20000 (models 78X4)	1	
Ramp-Up Timer, second	0.4 - 999.9, Low Range = OFF 0.5 - 999.9, Low Range = ON	0.1	± (0.1% + 0.05 sec)
Ramp-Down Timer, second	0.0, 1.0-999.9		
Dwell Timer, second	0, 0.4 - 999.9, (0=continuous) and 0, 1.0 - 999.9 when low current range is selected		
Ramp-HI, current, µA	0.0000 - 0.9999	0.0001	± (2% of setting + 10 counts) Low Range is ON
	1.000 - 9.999	0.001	
	10.00 - 99.99	0.01	
	100.0 - 999.9, Low Range = ON 0.0 - 999.9 Low Range = OFF	0.1	± (2% of setting + 2 counts)
	1000 - 10000 (Models 78X0) 1000 - 20000 (models 78X4)	1	
Charge-LO, current	0.0 - 350.0 µA DC or Auto Set, When current range is 3 ranges. 0.00 - 35.00 µA DC or Auto Set, When current range is 6 ranges.		
Discharge Time	≤ 50 ms for no load, < 100 ms for capacitor load (all capacitance values in MAX load spec below)		
Maximum Capacitive Load DC Mode	1µF < 1KV    0.08µF < 4KV		
	0.75µF < 2KV    0.04µF < 5KV		
	0.5µF < 3KV    0.015µF < 6KV		
Ground Continuity Current	Current: DC 0.1 A ± 0.01A, fixed		
	Max. Ground Resistance: 1.0Ω ± 0.1Ω		

Continued on next page →



	Range	Resolution	Accuracy
Current Offset, $\mu\text{A}$	0.0 - 10000 *(Total current + current offset $\leq 10\text{mA}$ ) 0.0 - 20000 $\mu\text{A}$ *(Total current + current offset $\leq 20\text{mA}$ )		
Arc Detection	1 - 9 ranges (9 = Highest sensitivity)		
<b>Fixed Range</b>			
DC Current, $\mu\text{A}$	0.0000 - 0.3500	0.0001	$\pm$ (2% of setting + 10 counts) Low Range is ON
	0.351 - 3.500	0.001	
	3.51 - 35.00	0.01	
	35.1 - 350.0 Low Range = ON 0.0 - 350.0 Low Range = OFF	0.1	$\pm$ (2% of setting + 2 counts)
	351 - 3500	1	
	350 - 20000	1	
<b>INSULATION RESISTANCE (Models 7800, 7804, 7850 and 7854)</b>			
Output Voltage, DC	10 - 1000	1	$\pm$ (1.5% of setting + 2 counts)
	1001 - 6000	1	$\pm$ (1.5% of setting + 5V)
Charging Current	Maximum > 20mA peak		
<b>SETTINGS</b>			
HI and LO-Limit, resistance, $\text{M}\Omega$	0.10 - 99.99 (HI - Limit: 0 = OFF)	0.01	0.10 - 999.9, $\pm$ (2% of setting + 2 counts)
	1.00 - 99.99 when voltage > 1000V		
	100.0 - 999.9	0.1	1000 - 9999, $\pm$ (5% of setting + 2 counts)
	1000-50000	1	10000 - 50000, $\pm$ (15% of setting + 2 counts)
Ramp-Up Timer, second	0.1 – 999.9	0.1	$\pm$ (0.1% + 0.05 sec)
Ramp-Down Timer, second	0.0, 1.0-999.9		
Dwell Timer, second	0, 0.5 - 999.9 or 0 (0=continuous)		
Delay Timer, second	0.5 - 999.9		
Charge-LO, current, $\mu\text{A}$	0.00 - 3.50 or Auto Set		
<b>GROUND BOND (Models 7804, 7854)</b>			
Output AC Current, A	1.00 - 40.00	0.01	$\pm$ (2 % of setting + 2 counts)
Output Voltage, Vac Open Circuit Mode	3.00 - 8.00	0.01	$\pm$ (2 % of setting + 3 counts) O.C.
Output Frequency, Hz	50Hz/60Hz $\pm$ 0.1%, User Selection		
Output Regulation	$\pm$ (1% of output + 0.02A), Within maximum load limits, and over input voltage range.		

Continued on next page →

<b>Maximum Loading</b>	1.00 - 10.00A/0 - 600mΩ		
	10.01 - 30.00A/0 - 200mΩ		
	30.01 - 40.00A/0 - 150mΩ		
<b>SETTINGS</b>			
	<b>Range</b>	<b>Resolution</b>	<b>Accuracy</b>
<b>Lead Resistance Offset, mΩ</b>	0 - 200	1	± (2 % of setting + 2 counts )
<b>HI and LO-Limit Resistance, mΩ</b>	0 - 150 (30.01-40.00A), 0 = OFF		6.00 - 40A, ± (2 % of setting + 2 counts )
	0 - 200 (10.01-30.00A), 0 = OFF		
	0 - 600 (6.00-10.00A), 0 = OFF		
	0 - 600 (1.00-5.99A) , 0 = OFF		
<b>Dwell Timer, second</b>	0, 0.5 - 999.9 (0 = continuous)	0.1	± (0.1% + 0.05 sec)
<b>HI and LO-Limit Voltage, V</b>	0 - 6.00 , 0 = OFF	0.01	± (2 % of setting + 2 counts )
<b>Offset, V</b>	0.00-6.00	0.01	± (2 % of setting + 2 counts )
<b>CONTINUITY TEST (All HypotULTRA Models)</b>			
<b>Output Current, DC</b>	1A for 0.000 - 1.000Ω		
	0.1A for 1.01 - 10.00Ω		
	0.01A for 10.1 - 100.0Ω		
	0.001A for 101 - 1000Ω		
	0.0001A for 1001 - 10000		
	1A is Max		
<b>SETTINGS</b>			
<b>Max-Lmt, Ω</b>	0.000 - 1.000	0.001	± (1% of setting + 3 counts)
	1.01 - 10.00	0.01	
	10.1 - 100.0	0.1	
	101 - 1000	1	
	1001 - 10000	1	± (1% of setting + 10 counts)
<b>Min-Lmt, Ω</b>	0.000 - 1.000	0.001	± (1% of setting + 3 counts)
	1.01 - 10.00	0.01	
	10.1 - 100.0	0.1	
	101 - 1000	1	
	1001 - 10000	1	± (1% of setting + 10 counts)
<b>Dwell Timer, second</b>	0.0, 0.4 - 999.9 (0=continuous)	0.1	± (0.1% + 0.05 sec)

Continued on next page →

Resistance Offset, $\Omega$	0.000 - 10.00	0.001 / 0.01	$\pm$ (1 % of setting + 3 counts)
<b>MEASUREMENT</b>			
Voltage, KV(AC/DC)	0.00 - 6.00	0.01	$\pm$ (1.5% of reading +1 count)
Voltage, Vdc (IR only)	1001 - 6000	0.01	$\pm$ (1.5% of reading + 5V)
	0 - 1000	1	$\pm$ (1.5% of reading + 2 counts)
	<b>Range</b>	<b>Resolution</b>	<b>Accuracy</b>
<b>Accuracy for AUTO range</b>			
AC Current (Total), mA	0.000 - 4.000 RMS (0.000 - 5.657 Peak)	0.001	$\pm$ (2% of reading + 2 counts)
	3.50 - 40.00 RMS (4.95 - 42.42 Peak)	0.01	
	3.50 - 99.99 RMS (7800/7854)	0.01	$\pm$ (2% of reading + 6 counts)
AC Current (Real), mA	0.00 - 9.999	0.001	$\pm$ (3% of reading + 50 $\mu$ A) All Ranges PF > 0.1 , V > 250VAC
	10.00 - 40.00 10.00 - 99.99 (7800/7854)	0.01	
DC Current, nA	0.0 - 400.0 DC (0.000 - 565.7 Peak)	0.1	$\pm$ (2% of reading + 10 counts) Low Range is ON
DC Current, $\mu$ A	0.350 - 4.000 DC (0.380 - 5.657 Peak)	0.001	
	3.50 - 40.00 DC (4.24 - 56.57 Peak)	0.01	
DC Current, mA	35.0 - 400.0 DC, Low Range = ON  (38.0 - 565.7 Peak) 0.0 - 400.0 DC, Low Range = OFF  (0.0 - 565.7 Peak)	0.1	$\pm$ (2% of reading + 2 counts)
	0.300 - 4.000 DC (0.424 - 5.657 Peak)	0.001	
	3.50 - 10.00 DC (3.80 - 14.14 Peak)	0.01	
DC Current, mA	3.00 - 20.00 DC (4.24 - 28.28 Peak)		
	AC Current, A (GB)	0.00 - 40.00	0.01

Continued on next page  $\rightarrow$

<b>Resistance, M<math>\Omega</math> (IR)</b>	10 - 499V	500 - 6000V		10 - 29V 0.05 - 999.9, ± (15% of reading + 2 counts)
				30 - 499V 0.05 - 999.9, ± (7% of reading + 2 counts)
	0.10 - 1.999	0.10 - 9.999 (1.00 - 9.999 V setting > 1000V)	0.001	500 - 6000V
	2.00-19.99	10.00 - 99.99	0.01	0.05 - 999.9, ± (2% of reading + 2 counts)
	20.00 - 199.9	100.00 - 999.9	0.1	1000 - 9999, ± (5% of reading + 2 counts)
	200 - 50000	1000 - 50000	1	10000 - 50000, ± (15% of reading + 2 counts)
	<b>Range</b>	<b>Resolution</b>	<b>Accuracy</b>	
<b>Resistance, <math>\Omega</math> (Continuity)</b>	0.00 - 1.000		0.001	± (1 % of reading + 3 counts)
	1.01 - 10.00		0.01	
	10.1 - 100.0		0.1	
	101 - 1000		1	
	1001 - 10000		1	± (1 % of reading + 10 counts)
<b>Resistance, m<math>\Omega</math> (GB)</b>	0-600		1	6.00 - 10.00 A, ± (2% of reading + 2 counts) 1.00 - 5.99 A, ± (3% of reading + 3 counts)
	0-200		1	10.01 - 30.00 A, ± (2% of reading + 2 counts)
	0-150		1	30.01 - 40.00 A, ± (2% of reading + 2 counts)
<b>Accuracy for Fixed range</b>				
<b>AC Current (Total), mA</b>	0.00 - 3.500		0.001	± (2% of reading + 2 counts)
	0.00 - 40.00		0.01	± (2% of reading + 2 counts) Additional error when reading < 6% of range ± (0.1% of range)
	0.00 - 99.99 (Model 7800 & 7854)		0.01	± (2% of reading + 2 counts) Additional error when reading < 3% of range ± (0.1% of range)
<b>DC Current, nA</b>	0.0 - 350.0		0.1	± (2% of reading + 10 counts) Low Range is ON

Continued on next page →

DC Current, $\mu$ A	0.000 - 3.500	0.001	$\pm$ (2% of reading + 10 counts) Low Range is ON Additional error when reading < 6% of range $\pm$ (0.1% of range)
	0.00 - 35.00	0.01	$\pm$ (2% of reading + 2 counts) Additional error when reading < 6% of range $\pm$ (0.1% of range)
	00.0 - 350.0	0.1	$\pm$ (2% of reading + 2 counts)
DC Current, mA	0.000 - 3.500	0.001	$\pm$ (2% of reading + 2 counts) Additional error when reading < 6% of range $\pm$ (0.1% of range)
	0.00 - 10.00 0.00 - 20.00	0.01	$\pm$ (2% of reading + 2 counts) Additional error when reading < 6% of range $\pm$ (0.2% of range)

## GENERAL SPECIFICATIONS

Safety Agency Listing	CE, cTUVus, RoHS 3
PLC Remote Control	Input: Test, Reset, Interlock, Recall File 1 through 3(Standard), Recall Test Files Hardware Interlock- Direct control sine wave and amplifier relay off when Interlock signal is disable.  Output:- Pass, Fail, Test-in-Process (Output relay contact ratings is 1AAC/125VAC, 0.5ADC/30VDC)
Memory	2000 steps 200 steps per memory max
Color LCD	4.3" Color Display (Touch Panel)
GFI	Built-in Smart GFI circuit, GFI trip current 0.4 – 5.0mA max, 0 = OFF. Resolution of 0.1 mA, HV shut down speed: <1mS Accuracy: +/- 0.1mA( on DC/50/60Hz and test under 1000V)
Multinational language	User interface available in English, Traditional Chinese, Simplified Chinese, Turkish, Portuguese, Spanish, German, French
Interface	Standard: USB/RS232 Optional: GPIB (IEEE-488.2), RS232/Ethernet or USB Printer
Security (Standard Password Protection)	Programmable User ID and Password capability to avoid unauthorized access to test set-up program.
Alarm Volume Setting	Range: 0 - 9 ; 0 = OFF, 1 is softest volume, 9 is loudest volume
Calibration	Software and adjustments are made through the front panel. Automatic Calibration alert function to signal operator when the next calibration is due.
Environment	Temperature: 0 - 40°C, Humidity: 20 - 80%
Dimension	Bench or rack mount (2U height) with tilt up front feet Dimensions (W x H x D) 16.92 x 3.50 x 15.75in (430 x 88.1 x 400 mm)

Continued on next page →

<b>Weight</b>	7800 = 45lb (20.4kg) 7804 = 41lb (18.6kg) 7820 = 34lb (15.4kg) 7850 = 35lb (15.9kg) 7854 = 46.3lb (21kg)
---------------	--

### **Why use the term "Counts"?**

Associated Research publishes some specifications using COUNTS which allows us to provide a better indication of the instrument's capabilities across measurement ranges. A COUNT refers to the lowest resolution of the display for a given measurement range. For example, if the resolution for voltage is 1V then 2 counts = 2V.

# Appendix C - Options

## Introduction

This section contains a list and descriptions of available factory installed options at the time of this printing. The list of options contains an option code number which can be referenced on the model option label on the rear panel of the unit when options are present.

## Model Option Label

On the rear panel of the instrument, you will find a label that contains the option code.

For example, your options code will appear as follows:

fitted with option 01 OPT: 01

fitted with option 01 and 02 OPT: 0102

## HypotULTRA Options

CODE	DESCRIPTION
01	Internal 8 Channel Scanner with Continuity (7820 & 7850 only)
02	Internal 4 Channel Scanner with Continuity (7820 & 7850 only)
04	3mA AC/DC Output (7804, 7820 & 7850 only)
05	5mA AC/DC Output (7804, 7820 & 7850 only)
07	Printer Port (Discontinued)
08	GPIB Card (all models)
09	Ethernet Card (all models)
10	Burn Hipot Test (7820, 7850 & 7804 only)
12	Negative DCW/IR (7850, 7800, 7804, 7854)
13	400/800 Hz AC Hipot Output (7820, 7850 & 7804 only)
15	DCW 6kV/50mA with Discharge Circuit (model 7800 only)
16	Advanced ARC Detection

### 01 Internal 8 Channel Scanner with Continuity

The Scanner option provides 8 high voltage/continuity channels on the rear panel of the HypotULTRA. The high voltage/continuity channels can be set to a High (H) or Low (L) level giving the operator the capability to test from one channel to another channel or from any channel to a common Low or Return point. The channels can be connected in parallel if desired but there is only one leakage current measurement for all channels.

### 02 Internal 4 Channel Scanner with Continuity

This option is the same as Option 01, 8 Channel Scanner with Continuity, with the exception that the numbers of channels are limited to 4. The Scanner functions the same as the 8-channel option but the Scanner status display will only indicate the status of channels 1-4, even though all 8 channel indicators are displayed.

### 04 3mA AC/DC Output

The 3 mA AC Output option limits the AC Dielectric Withstand Mode output current with software control. The trip points are adjusted to a maximum of 3 mA and the software has been modified so the high-speed maximum current shutdown is fixed at 3 mA. The following table shows the specifications for this option:

3mA AC / DC Output			
AC WITHSTAND VOLTAGE			
SETTINGS			
HI and LO-Limit (Total), current, mA	0.000-3.000	0.001	± (2% of setting + 6 counts)
HI and LO-Limit (Real), current, mA	0.000-3.000	0.001	± (3% of setting + 50µA)
MEASUREMENT			
HI and LO-Limit (Total), current, mA	0.000-3.000	0.001	± (2% of setting + 2 counts)
HI and LO-Limit (Real), current, mA	0.000-3.000	0.001	± (3% of setting + 50µA)
Current Offset	0.000 - 3.000mA (PF=0.00-1.00) *(Total current + current offset ≤3.000mA)		
Short Circuit Protection	Minimum current 3.5mA RMS at short circuit, Response time < 2ms		
DC WITHSTAND VOLTAGE			
SETTINGS			
HI and LO-Limit, current, nA	0.0-999.9	0.1	± (2% of setting + 10 counts) Low Range is ON
	1000 - 9999	1	
HI and LO-Limit, current, µA	10.00 - 99.99	0.01	± (2% of setting + 2 counts)
	100.0 - 999.9 , Low range = ON	0.1	
	0.0 - 999.9 , Low range = OFF		
	1000 - 3000	1	

Continued on next page →



MEASUREMENT			
DC Current, nA	0.0 - 400.0 DC (0.000 - 565.7 Peak)	0.1	± (2% of setting + 10 counts) Low Range is ON
DC Current, µA	0.350 - 4.000 DC (0.380 - 5.657 Peak)	0.001	
	3.50 - 40.00 DC (3.80 - 56.57 Peak)	0.01	
	35.0 - 400.0 DC, Low Range = ON (38.0 - 565.7 Peak)	0.1	± (2% of setting + 2 counts)
0.0 - 400.0 DC, Low Range = OFF (0.0 - 565.7 Peak)			
DC Current, mA	0.300 – 3.000 DC (0.424 - 4.242 Peak)	0.001	
Current Offset	0.000 - 3.000mA (PF=0.00-1.00) *(Total current + current offset ≤ 3.000mA)		
Short Circuit Protection	Minimum current 3.5mA DC at short circuit, Response time < 2ms		

### 05 5mA AC/DC Output

The 5mA Output option limits the output current with software control. The trip points are adjusted to a maximum of 5mA and the software has been modified so the high-speed maximum current shutdown is fixed at 5mA. The following table shows the specifications for this option:

5mA AC / DC Output			
AC WITHSTAND VOLTAGE			
SETTINGS			
HI and LO-Limit (Total), current, mA	0.000-5.000	0.001	± (2% of setting + 6 counts)
HI and LO-Limit (Real), current, mA	0.000-5.000	0.001	± (3% of setting + 50µA)
MEASUREMENT			
HI and LO-Limit (Total), current, mA	0.000-3.500 RMS (0.000 - 5.657 Peak)	0.001	± (2% of setting + 2 counts)
	3.00-5.00 mA RMS (4.24 - 7.07 Peak)	0.01	
HI and LO-Limit (Real), current, mA	0.000-3.500	0.001	± (3% of setting + 50µA)
	3.00- 5.00	0.01	
Current Offset	0.000 - 5.00mA (PF=0.00-1.00) *(Total current + current offset ≤ 5.00mA)		
Short Circuit Protection	Minimum current 5.8mA RMS at short circuit, Response time < 2ms		

Continued on next page →

## DC WITHSTAND VOLTAGE

### SETTINGS

HI and LO-Limit, current, nA	0.0-999.9	0.1	± (2% of setting + 10 counts) Low Range is ON
	1000 - 9999	1	
HI and LO-Limit, current, uA	10.00 - 99.99	0.01	± (2% of setting + 2 counts)
	100.0 - 999.9 , Low range = ON	0.1	
	0.0 - 999.9 , Low range = OFF		
	1000 - 5000	1	

### MEASUREMENT

DC Current, nA	0.0 - 400.0 DC (0.000 - 565.7 Peak)	0.1	± (2% of setting + 10 counts) Low Range is ON
DC Current, uA	0.350 - 4.000 DC (0.380 - 5.657 Peak)	0.001	
	3.50 - 40.00 DC (3.80 - 56.57 Peak)	0.01	
	35.0 - 400.0 DC, Low Range = ON (38.0 - 565.7 Peak)	0.1	± (2% of setting + 2 counts)
	0.0 - 400.0 DC, Low Range = OFF (0.0 - 565.7 Peak)		
DC Current, mA	0.300 – 4.000 DC (0.424 - 5.657 Peak)	0.001	
	3.50 - 5.00 RMS (3.80 - 7.07 Peak)	0.01	
Current Offset	0.000 - 3.000mA (PF=0.00-1.00) *(Total current + current offset ≤3.000mA)		
Short Circuit Protection	Minimum current 5.8mA DC at short circuit, Response time < 2ms		

## 07 Printer Port (Discontinued)

This option allows the instrument to generate a hard copy printout of the test results. The printout can be configured to print automatically with each test or manually by pressing a front panel key. There is also the capability to enter a device ID number for each test that will increment automatically after each test is performed. The test can be further configured to print only results from tests that have failed or to print all test results from every test performed.

The Printer Port is a USB interface and should be compatible with most USB printers. The printer port output uses simple ASCII characters and control codes. Simply connect the printer to the HypotULTRA and configure the printer output using the Setup Systems menu. Once the Printer Port option is installed select the Setup System screen and the Print Format icon will now be displayed:



Select the Print Format icon and the next screen will display all the parameters for this option:

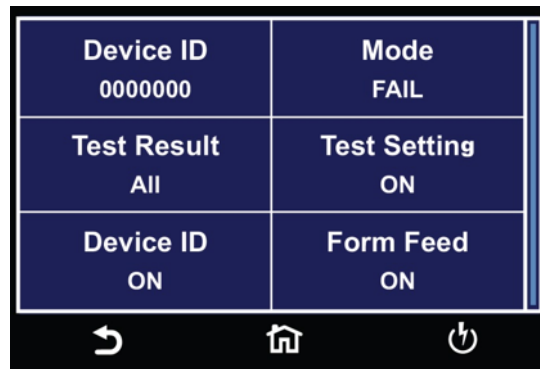

From the Print Format setting screen, six different parameters may be accessed; Device ID number, Mode, Test Result, Test Setting, Device ID, and Form Feed.

### Mode

From the Print Format setting screen, select "Mode" and the following screen will appear:

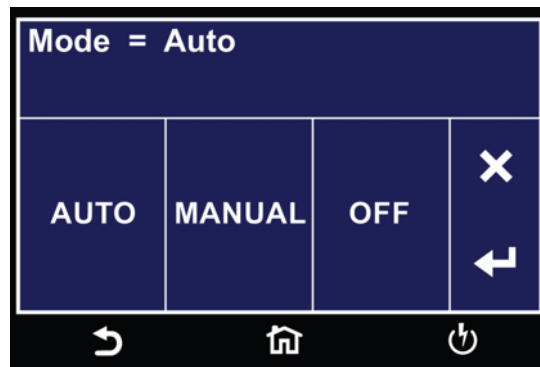

The three modes available are Auto, Manual and OFF. In the Auto mode, the HypotULTRA will automatically send the test results to the printer at the end of every complete test. If Manual mode is selected, at the end of the test you will need to select the Results icon to view the results. Under Results you will then select Present test. The next screen will display the results of the present test along with an option of Print Results. You can then select Print Results to send the test results to a printer.

OFF mode disables the printer card and printer menu.

### Test Result

From the Print Format Setting screen, select "Test Result":

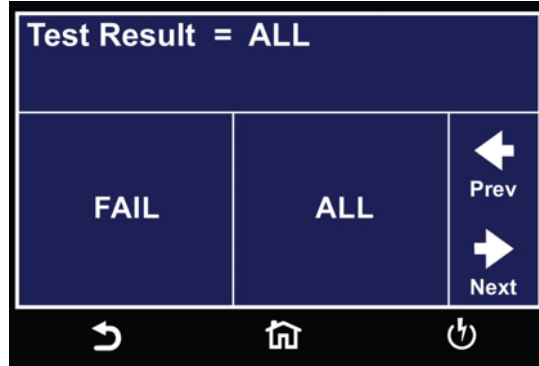

The two options available for Test Result are "All" and "Fail". This option allows you to select which test results will be printed. "All", selects printing all test results and "Fail only", selects printing only failed test results.

### Test Setting

From the Print Format setting screen you can turn the Test Setting print enable ON and OFF. This parameter selects printing the test parameters as well as the test results:

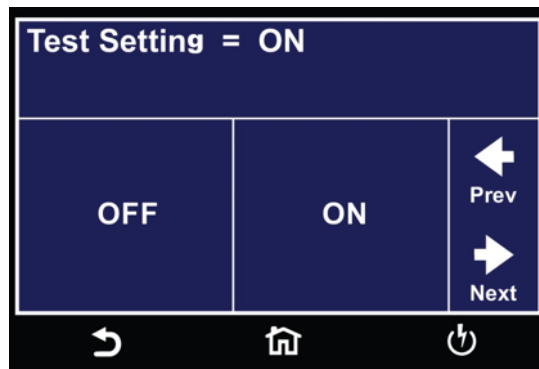

### Device ID

The Device ID parameter appears twice in under the Print Format option. The first parameter allows you to set the Device ID to ON or OFF:

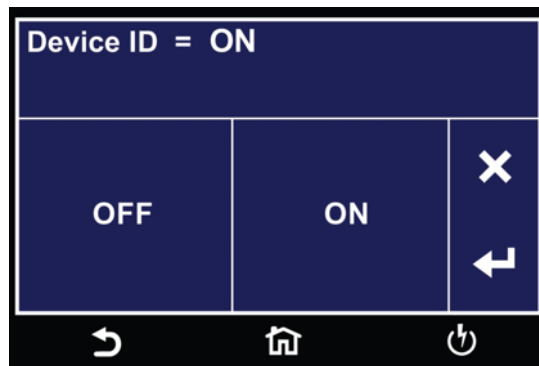

The Device ID number is a counter that increments once every time a test is performed. The number can be set to match the exact serial number or some portion of the actual serial number of the item under test, or just used as an identifier or tracking number. From the Print Format Setting screen select Device ID:

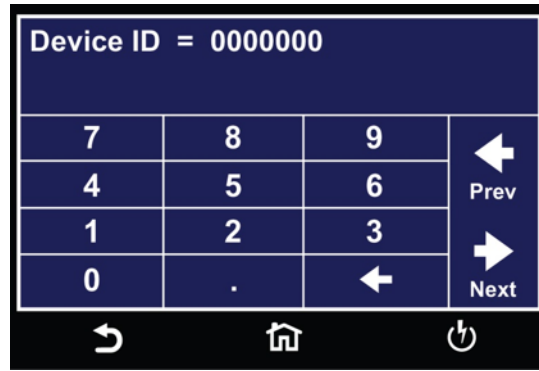

The Device ID number can be entered and saved using the touchscreen keypad.

### Form Feed

From the Print Format Setting screen, you may turn the Form Feed ON and OFF by selecting the "Form Feed". This parameter forces a form feed after each complete test sequence. When the form feed is turned OFF, the signature line will not appear. When the form feed is turned ON the pages will break whenever the page is determined to be full by the printer:

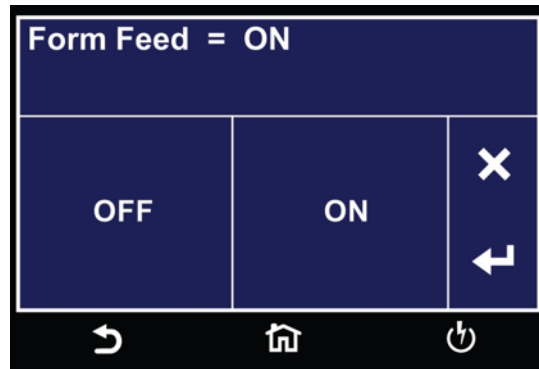

### 08 GPIB Card

This option may be substituted for the RS232 interface. This option provides all of the function control of the RS232 interface with the addition of SRQ functions. All commands can be found in section 7. Bus Remote Interface GPIB/USB/RS-232 of this manual.

### 09 Ethernet Card

The Ethernet Card option provides RS-232 and Ethernet communication interfaces, as well as barcode scanning capability.

The Ethernet Card has three input/output ports, shown in the following figure:

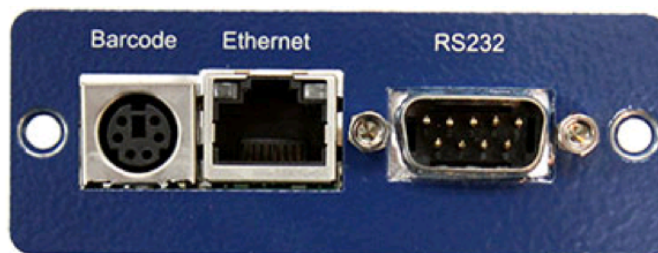

The port labeled "Barcode" is a PS/2-type connector that is used for the connection of a barcode scanner. The Ethernet port is for use with a standard CAT-5 Ethernet cable and may be connected to any compatible PC. The 9-pin D-type subminiature connector labeled "RS232" is for connection of the HypotULTRA to an RS-232 communication bus.

**RS-232 Interface**

The protocol for interfacing and communicating using the RS-232 interface can be found in section 8. Bus Remote Interface GPIB/USB/RS-232 of this manual.

**Ethernet Interface**

The Ethernet interface provides all of the function control of the standard RS-232 interface. Some commands are only exclusive to GPIB control.

**Default Settings**

The default settings for the Ethernet interface are as follows:

IP Setup: AUTO  
IP Address: 010.000.000.000  
Gateway IP: 000.000.000.000  
Subnet Mask: 255.000.000.000

The source port number for the **Ethernet Card in TCP connections is 10001.**

**Ethernet Card Setup**

In order to setup the Ethernet card, the operator will need information from the local network administrator. Please have your network administrator fill out the required information on the next page and keep it for your records:

**Associated Research  
Ethernet Card Communications Information**  
*(To be completed by Network Administrator)*

Ethernet Card Address: \_\_\_\_\_:\_\_\_\_\_:\_\_\_\_\_:\_\_\_\_\_:\_\_\_\_\_

Device Name: \_\_\_\_\_

Device IP Address: \_\_\_\_\_.

Gateway IP Address: \_\_\_\_\_.

Subnet Mask: \_\_\_\_\_.

### Saving New Settings

Any time you edit one of the Ethernet Card parameters and exit the Ethernet Card Settings menu, HypotULTRA displays the following message:

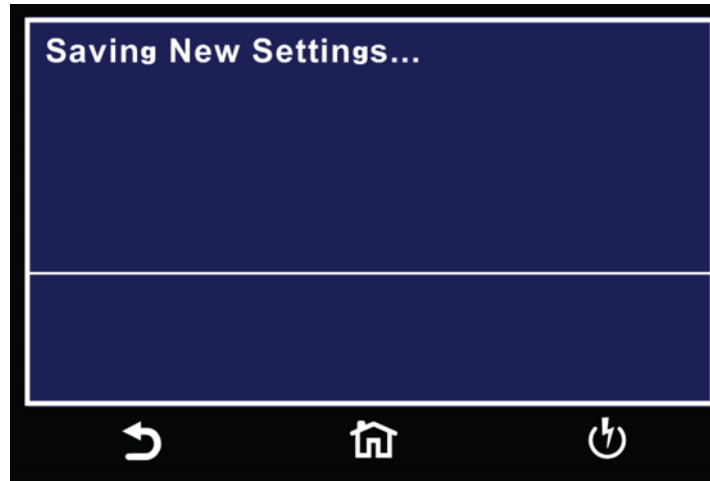

The Ethernet Card will attempt to re-establish a connection with the server anytime you modify a parameter and exit the Ethernet Card Parameters Menu or use the command set at the end of this option description. Thus, if the IP Setup is set to AUTO, the Ethernet Card will request a new IP Address every time a parameter is edited and, as a result, the "Requesting IP Address. . ." message will appear.

### Power Up

The Ethernet Card will be installed with the default options listed above. After the HypotULTRA initially powers up, the following pop-up message will appear:

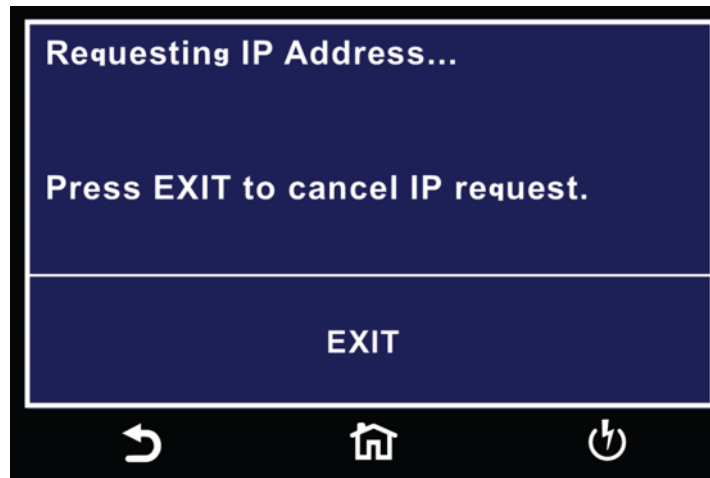

**NOTE:** The "Requesting IP Address..." pop-up message only appears at power up when the Ethernet Card has its IP Setup configured to AUTO.

There are two options to choose from this screen. Select the EXIT key to escape from this screen and stop the HypotULTRA from requesting an IP address or allow the HypotULTRA to request an IP address automatically from the network to which it is connected.

The Ethernet Card will wait for an IP Address for approximately 20 seconds. If the HypotULTRA successfully receives an IP Address from the server the following pop-up message will be displayed:



If the HypotULTRA® fails to receive an IP Address after approximately 20 seconds, the following pop-up message will be displayed:

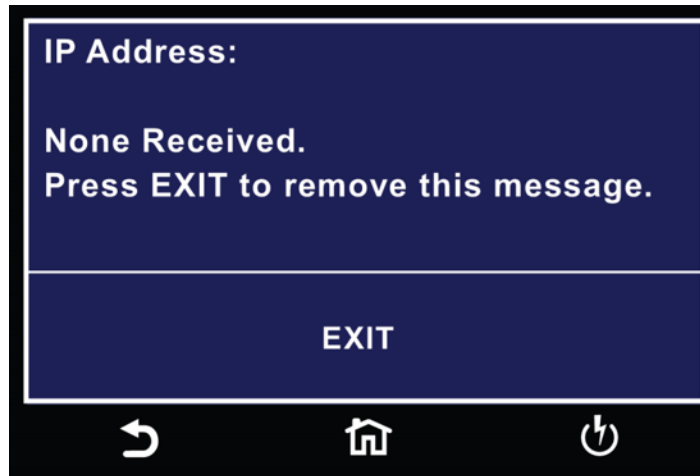

Select the EXIT key to remove the pop-up message.



## Ethernet Card Menu

When the Ethernet Card option is installed, the "Ethernet Card" icon will appear in the System Settings menu.

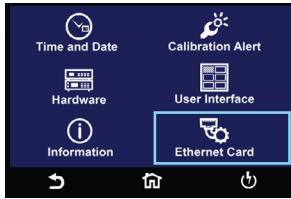

System Menu

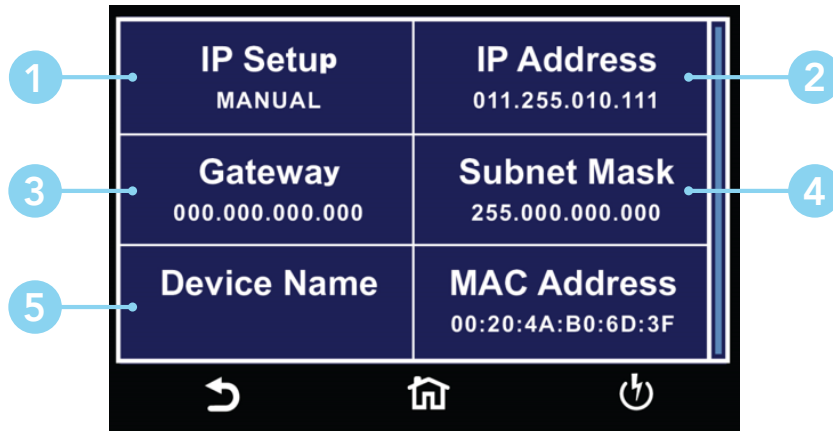

Ethernet Card Menu

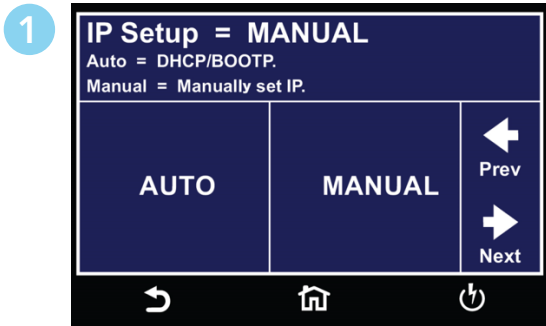

Select IP Setup Manual or Auto.

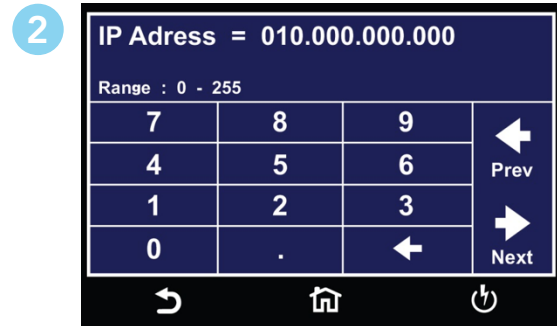

Enter IP Address.

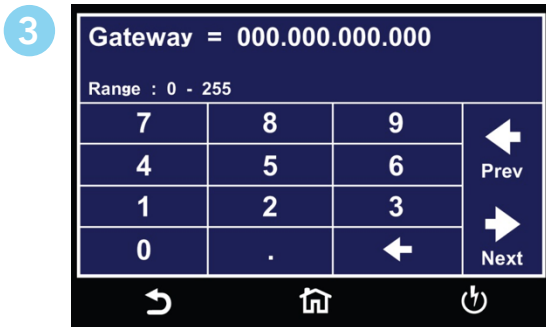

Enter Gateway IP Address.

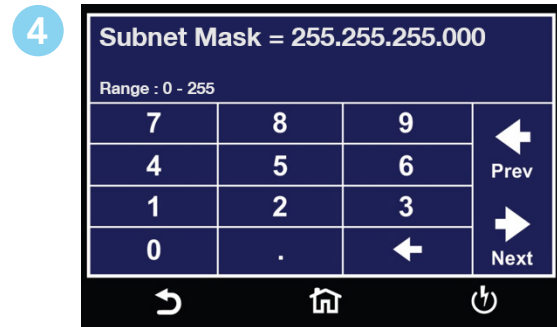

Enter Subnet Mask.



Enter Device Name.

<b>IP Setup</b>	IP Setup is used to determine how the HypotULTRA will request an IP address from the server to which it is connected. When AUTO is selected, the HypotULTRA will attempt to automatically request an IP Address from the server upon power up. To resolve the IP Address automatically, the HypotULTRA will use DHCP or BOOTP protocols. When MANUAL is selected, the HypotULTRA will request a specific IP Address from the server. The IP Address that will be requested must be entered in the subsequent IP Address parameter field.
<b>IP Address</b>	A specific IP Address must be entered into this field if the IP Setup parameter is configured to MANUAL. Enter the IP Address that you wish using the numeric keypad. The IP Address must be entered in the following format: XXX.XXX.XXX.XXX. A valid IP Address must be entered. Users may not use the following IP Addresses:  255.255.255.255 000.000.000.000
<b>Gateway IP</b>	A specific Gateway IP must be entered into this field if the IP Setup parameter is configured to MANUAL. Enter the Gateway IP using the touchscreen keypad. The Gateway IP must be entered in the following format: XXX.XXX.XXX.XXX.
<b>Subnet Mask</b>	Select the Subnet Mask parameter using the touchscreen. A specific Subnet Mask must be entered into this field if the IP Setup parameter is configured to MANUAL. Enter the Subnet Mask using the touchscreen keypad. The Subnet Mask must be entered in the following format: XXX.XXX.XXX.XXX.  If the IP Setup parameter is set to AUTO, you do not need to enter a Subnet Mask manually.
<b>Device Name</b>	The Device Name is used to identify the HypotULTRA on your server and may be used in place of a dedicated IP Address.  The Device Name parameter is only active when the IP Setup is set to AUTO.
<b>Mac Address</b>	View the MAC address of the Ethernet Card. This parameter is not adjustable.

## Ethernet Card Settings Commands and Companion Queries

COMMAND	NAME	VALUE
SIM {1 0} SIM?	Set IP Mode	1=Manual, 0=Auto
SIA <value> SIA?	Set IP Address	Dotted decimal form. Ex. 192.168.1.50
SGA <value> SGA?	Set Gateway IP Address	Dotted decimal form
SSM <value> SSM?	Set Subnet Mask	Dotted decimal form
SDN <value> SDN?	Set Device Name	Any word
MAC?	MAC Address Query	Example response: 00:20:4A:8B:B4:30
<b>Mimic HU3 Command Set (Discontinued)</b>		
SBI {4 3 2 1 0} SBI?	Set Barcode Input	0=Off, 1=Serial# and Product#, 2=Serial# Only, 3=Product# Only, 4=Run File
SAS {1 0} SAS?	Set Autostart	1=On, 0=Off

### Communication Considerations

- All of the above commands (excluding the query commands) will respond with the 06 hex (6 decimal) Acknowledge (ACK) ASCII control code if the transfer was recognized by the instrument.
- If there was an error with the command string, the instrument will respond with 15 hex (21 decimal), the Not Acknowledge (NAK) ASCII control code.
- However, the presence of this response does not mean that the instrument (in the case of these commands only) completed the command. These commands require a restarting of the hardware that controls the Ethernet Protocols. Because of this, you must wait before the Ethernet Card will respond to another command. See the table below for the approximate wait times necessary after one of the commands in the table is sent. In addition, the current socket connection between you terminal and the Ethernet Card is no longer valid, and you will need to close their current connection and establish a new one.

### Ethernet Card Settings Command Wait Times

IP MODE	COMMAND	WAIT TIME AFTER COMMAND IS SENT*
<b>Manual</b>	SIA, SGA, SSM	8 seconds
	SIM 0	14 seconds
<b>Auto</b>	SDN	14 seconds
	SIM 1	8 seconds

\*Wait times are approximate and can vary based on the user's network.

## 10 Burn Hipot Test

The Burn Hipot Test option allows you to repeat two ACW test periods during one step which yields a single test result. The first test of the step performs the Burn function and the second test performs the standard AC Withstand test. The Burn part of the test can also be deactivated by setting the Burn to OFF in the Edit menu of each step. When Burn is set to OFF the test will not be repeated, therefore only one ACW test will be performed. To activate the Burn mode, be sure that the Burn setting is set to ON for each step of the memory that the Burn period is required.

### CAUTION

During the Burn period visual arcing or short circuit conditions that would typically disable the high voltage will cause the high voltage to be reactivated.

During the Burn period of the test the Max\Min Limits and ARC failures are disabled. If a Breakdown or Short occurs during the Burn function that exceeds 30mA the Burn test will be discontinued and proceed to the standard ACW test period. If the current remains below 30mA, the Burn test will continue for the full time that has been programmed before restarting the ACW test period.

The Burn Hipot Test option reduces the standard minimum Dwell time from 0.4 seconds to 0.1 seconds. The option optimizes the single test cycle time and results in a fast overall test cycle time of two tests in less than 600ms; measured from the Remote Test input to the Remote Pass output.

The Ramp UP, Dwell, and Ramp DN cycle times as well as the Test Voltage settings apply to both the Burn and standard ACW portions of the test. To minimize the cycle time and achieve the 600ms overall test time the Ramp UP and Dwell times must be set to the minimum of 0.1s and Ramp DN should be disabled by setting it to 0.0s.

In order to provide the decreased cycle time some of the instruments normal functions have been limited or disabled. If the Dwell time is set to less than 0.4 seconds the Real current meter, auto-ranging, and the Results selection in the System Menu will all be disabled. The current meter range will be determined by the Max Limit setting of the tests. The meter will be set to a fixed range so that it can accurately measure the current to perform the Max limit judgment during the ACW period. The Results selection will be preset to "Last" and the "All" and "P/F" settings (Pass/Fail) will not be available.

The following specifications will be altered by the installation of the Burn Hipot Test option, all other specifications will remain the same.

### BURN SPECIFICATIONS

<b>Dwell Timer</b>	Range: 0.0, 0.1 – 999.9 sec (0 = Continuous) Resolution: 0.1 sec Accuracy: ± (0.1% + 0.05 sec)
<b>HI-Limit and LO-Limit AC Real</b>	Disabled for Dwell time settings of < 0.4 seconds
<b>Current Display AC Real</b>	Disabled for Dwell time settings of < 0.4 seconds

## 12 Negative DCW/IR

The Negative DCW/IR option, when activated, adds an additional test parameter "Output Polarity" with two selections, + and -. Set this parameter to "-" to apply DC voltage in negative polarity during the DCW or IR tests. Set this parameter to "+" to apply DC voltage in normal/positive polarity. The following table shows the specifications for this option:

Test Type DCW	Voltage 1500V
Output Polarity +	HI-Limit 20000uA
LO-Limit 0.0uA	Ramp Up 0.4s

NEGATIVE DCW			
Output Voltage, DCV	0 - (-6000)	1	± (1.5% of setting + 5V)
DC Output Ripple	<4 % (-6KV/10mA at Resistive Load)		
SETTINGS			
Auto Range			
	Range	Resolution	Accuracy
HI and LO-Limit, current, uA	0.0000-0.9999	0.0001	± (2% of setting + 10 counts) Low Range is ON
	1.000 - 9.999	0.001	
	10.00 - 99.99	0.01	
	100.0 - 999.9 , Low range = ON 0.0 - 999.9 , Low range = OFF	0.1	± (2% of setting + 2 counts)
	1000 - 10000	1	
Ramp-Up Timer, second	0.4 - 999.9	0.1	± (0.1% + 0.05 sec)
Ramp-Down Timer, second	0.0, 1.0-999.9 0, 0.4 - 999.9 ,(0=continuous) and 0, 1.0 - 999.9 when it be selected low current range.		
Ramp-HI, current , uA	0.0000-0.9999	0.0001	± (2% of setting + 10 counts) Low Range is ON
	1.000 - 9.999	0.001	
	10.00 - 99.99	0.01	
	100.0 - 999.9	0.1	± (2% of setting + 2 counts)
	1000 - 10000	1	
Charge-LO, current	0.0 - 350.0 µA DC or Auto Set, When current range is 3 ranges. 0.00 - 35.00 uA DC or Auto Set, When current range is 6 ranges.		
Discharge Time	≤ 50 msec for no load, < 100 msec for capacitive load		
Maximum Capacitive Load DC Mode	1µF < 1KV 0.08µF < 4KV		
	0.75µF < 2KV 0.04µF < 5KV		
	0.5µF < 3KV 0.015uF < 6KV		

Continued on next page →

<b>Ground Continuity Current</b>	Current: DC 0.1 A $\pm$ 0.01A, fixed		
	Max. Ground Resistance: 1.0 $\Omega$ $\pm$ 0.1 $\Omega$		
<b>Current Offset (like U3)</b>	0.0 - 10000 $\mu$ A *(Total current + current offset $\leq$ 10mA)		
<b>Arc Detection</b>	1 - 9 ranges (9 is the most sensitivity)		
<b>Fixed Range</b>			
	<b>Range</b>	<b>Resolution</b>	<b>Accuracy</b>
<b>DC Current, <math>\mu</math>A</b>	0.0000 - 0.3500	0.0001	$\pm$ (2% of setting + 10 counts) Low Range is ON
	0.351 - 3.500	0.001	
	3.51 - 35.00	0.01	
	35.1 - 350.0 , Low range = ON 0.0 - 350.0 , Low range = OFF	0.1	$\pm$ (2% of setting + 2 counts)
	351 - 3500	1	
	3501 - 10000	1	
<b>Measurement</b>			
<b>Voltage, KV(AC/DC)</b>	0.00-(-6.00)	0.01	$\pm$ (1.5% of reading +1 count)
<b>Accuracy for Auto Range</b>			
<b>DC Current, nA</b>	0.0 - 400.0 DC (0.000 - 565.7 Peak)	0.1	$\pm$ (2% of reading + 10 counts) Low Range is ON
	0.350 - 4.000 DC (0.380 - 5.657 Peak)	0.001	
	3.50 - 40.00 DC (3.80 - 56.57 Peak)	0.01	
	35.0 - 400.0 DC, Low Range = ON (38.0 - 565.7 Peak)	0.1	$\pm$ (2% of reading + 2 counts)
	0.0 - 400.0 DC, Low Range = OFF (0.0 - 565.7 Peak)		
<b>DC Current, mA</b>	0.300 - 4.000 DC (0.424 - 5.657 Peak)	0.001	$\pm$ (2% of reading + 2 counts)
	3.50 - 10.00 DC (3.80 - 14.14 Peak)	0.01	
<b>Accuracy for Fixed Range</b>			
<b>DC Current, nA</b>	0.0 - 350.0	0.1	$\pm$ (2% of reading + 10 counts) Low Range is ON
<b>DC Current, <math>\mu</math>A</b>	0.000 - 3.500	0.001	$\pm$ (2% of reading + 10 counts) Low Range is ON
	0.00 - 35.00	0.01	Additional error when reading < 6% of range $\pm$ (0.1% of range)
	00.0 - 350.0	0.1	

Continued on next page  $\rightarrow$

	Range	Resolution	Accuracy
DC Current, mA	0.000 – 3.500	0.001	± (2% of reading + 2 counts)  Additional error when reading < 6% of range  ± (0.1% of range)
	0.00 - 10.00	0.01	± (2% of reading + 2 counts)  Additional error when reading < 6% of range  ± (0.2% of range)

## NEGATIVE IR

Output Voltage, DC V	(-1001) - (-6000)	1	± (1.5% of setting + 5V)
	(-100) -(-1000)	1	± (1.5% of reading + 2 counts)
Charging Current	Maximum >10mApeak		

## SETTINGS

HI and LO-Limit, resistance, MΩ	0.10 - 99.99 (HI – Limit: 0 = OFF) 1.00 - 99.99 when voltage > 1000V	0.01	0.10–999.9, ±(2% of setting+2 counts)
	100.0-999.9	0.1	1000–9999, ±(5% of setting+2 counts)
	1000-50000	1	10000–50000, ±(15% of setting+2 counts)
Ramp-Up Timer, second	0.1 – 999.9	0.1	± (0.1% + 0.05 sec)
Ramp-Down Timer, second	0.0, 1.0-999.9		
Dwell Timer, second	0, 0.5 - 999.9 or 0		
Delay Timer, second	0.5 - 999.9		
Charge-LO, current, μA	0.000 - 3.500 or Auto Set		

MEASUREMENT			
Voltage, KV(AC/DC)	0.00-(-6.00)	0.01	± (1.5% of reading +1 count)
Voltage, Vdc (IR only)	(-1001) - (-6000)	0.01	± (1.5% of setting + 5V)
	(-100) - (-1000)	1	± (1.5% of reading + 2 counts)
Accuracy for AUTO range			
DC Current, nA	0.0 - 400.0 DC (0.000 - 565.7 Peak)	0.1	± (2% of setting + 10 counts) Low Range is ON.
DC Current, µA	0.350 - 4.000 DC (0.380 - 5.657 Peak)	0.001	
	3.50 - 40.00 DC (3.80 - 56.57 Peak)	0.01	
	35.0 - 400.0 DC, Low Range = ON (38.0 - 565.7 Peak) 0.0 - 400.0 DC, Low Range = OFF (0.0 - 565.7 Peak)	0.1	± (2% of reading + 2 counts)

DC Current, mA	0.300 – 4.000 DC (0.424 - 5.657 Peak)		0.001		
	3.50 - 10.00 DC (3.80 - 14.14 Peak)		0.01		
Resistance, MΩ (IR)	(-10) - (-499)V	(-500) - (-6000)V		(-10) - (-29)V	
				0.05–999.9, ±(15% of reading+2 counts)	
				(-30) - (-499)V	
					0.05–999.9, ±(7% of reading+2 counts)
	0.100-1.999	0.100-9.999 (1.000-9.999 V set- ting>-1000V)	0.001		(-500) - (-6000)V
	2.00-19.99	10.00-99.99	0.01		0.05–999.9, ±(2% of reading+2 counts)
	20.0-199.9	100.0-999.9	0.1		1000–9999, ±(5% of reading+2 counts)
200-50000	1000-50000	1		10000–50000, ±(15% of reading+2 counts)	



Accuracy for Fixed range			
DC Current, nA	0.0 - 350.0	0.1	± (2% of setting + 10 counts) Low Range is ON.
DC Current, µA	0.000 -3.500	0.001	± (2% of setting + 10 counts) Low Range is ON. Additional error when reading < 6% of range. ± (0.1% of range)
	0.00 - 35.00	0.01	
	00.0 - 350.0	0.1	± (2% of reading + 2 counts)
DC Current, mA	0.000 – 3.500	0.001	± (2% of reading + 2 counts) Additional error when reading < 6% of range. ± (0.1% of range)
	0.00 - 10.00	0.01	± (2% of reading + 2 counts) Additional error when reading < 6% of range. ± (0.2% of range)

## Test Parameter Editing Commands and Companion Queries

These additional commands are used to modify the DCW/IR test parameter with Option 12 Negative DCW/IR. All previous listed commands for DCW and IR test also apply to Negative DCW and IR when Option 12 is installed. These commands require a parameter value to be included with the command. The companion query command will read the parameter. The writing of the parameter requires that the unit not be included with the value, only the numeric value should be included with the command. Also, when the query commands are used the response will not include the unit's characters. Many of the commands will function the same way for multiple test types; however, the input range may be different and therefore used a different possible set of values.

COMMAND	NAME	TEST TYPES	VALUE
EPO n EPO?	Output Polarity	DCW IR	n= 0-1 0 = "+" (Positive) 1 = "-" (Negative)

### ADD3 <n, p1,p2,p3...>

This command adds a step with all parameters to the current file. See the command summary tables below to see the specific test type for each of these commands

The parameter <n> indicates the test type. The values DCW or IR must be used. The parameters <p1,p2> etc. indicate the individual settings for each parameter of the test. All parameters must be included with the command and should appear in the same order that is shown in the table below. Also, like the individual parameter editing commands, the unit should not be included with the value; only the numeric value should be included in the command string. When the scanners are being used they should be appended to the end of the string, with the internal scanner first if installed, followed by the external scanner if connected to the rear panel scanner control port.

The parameter values for file editing commands should use complete text (i.e. "ON" and "OFF" or "Real" and "Total") and not use the coded values that are associated with the test parameter setting commands discussed in Test Parameter Editing Commands and Companion Queries. The LS3? companion command will also list all parameters in complete text in the order as they appear in the following table, preceded by the step number. The following table shows examples of the ADD3 and LS3 commands:

ADD3 all parameters for one STEP	
ADD3 DCW	Voltage,Output Polarity,HI-Limit,LO-Limit,Ramp Up,Dwell Time,Ramp Down,Charge LO,Arc Sense,Offset,Ramp-HI,Arc Detect,Continuity, Range,Low Range,Scanner Setup
ADD3 IR	Voltage,Output Polarity,HI-Limit,LO-Limit,Ramp UP,Delay Time,Dwell Time,Ramp Down,Charge LO,Scanner Setup
LS3? & LS3 nn?	Response Data format
Step number, DCW	Voltage,Output Polarity,HI-Limit,LO-Limit,Ramp Up,Dwell Time,Ramp Down,Charge LO,Arc Sense,Offset,Ramp-HI, Arc Dectect,Continuity,Range,Low Range,Scanner Setup
Step number, IR	Voltage,Output Polarity,HI-Limit,LO-Limit,Ramp UP,Delay Time, Dwell Time,Ramp Down,Charge LO,Scanner Setup

	-DCW	-IR
1	Voltage	Voltage
2	Output Polarity	Output Polarity
3	HI-Limit	HI-Limit
4	LO-Limit	LO-Limit
5	Ramp Up	Ramp Up
6	Dwell Time	Delay Time
7	Ramp Down	Dwell Time
8	Charge-LO	Ramp Down
9	Arc Sense	Charge-LO
10	Ramp-HI	Internal Scanner (opt)
11	Arc Detect (ON/OFF)	External Scanner (opt)
12	Continuity (ON/OFF)	
13	Internal Scanner (opt)	
14	External Scanner (opt)	

## ADD3 Command String Examples

Use the following ADD3 command string to setup a corresponding test with the listed parameters. The command string below can be copied exactly as it appears. The parameters can be edited and sent to the tester via BUS command.

### DCW Test

Test	Voltage	Polarity	Hi-Limit	LO-Limit	Ramp Up	Dwell Time	Ramp Down	Charge LO	Arc Sense	Offset	Ramp-Hi	Arc Detect	Continuity	Range	Low Range	Scanner (Optional)
DCW	1500	-	10000	0.0	0.4	1.0	0.0	0.0	5	0.0	0.0	OFF	OFF	AUTO	OFF	Optional

ADD3 DCW,1500,-,10000,0.0,0.4,1.0,0.0,0.0,5,0.0,0.0,OFF,OFF,Auto,OFF

### Insulation Resistance Test

Test	Voltage	Polarity	Hi-Limit	Lo-Limit	Ramp Up	Delay Time	Dwell Time	Ramp Down	Charge-LO	Scanner (Optional)
IR	500	+	0.00	0.10	0.1	0.5	0.5	0.0	0.000	Optional

ADD3 IR,500,+,0.00,0.10,0.1,0.5,0.5,0.0,0.000

Use the following example command string with tester that includes optional scanners channels. The BUS command follows similar structure to the ADD3 command string mentioned above.

ADD3 DCW,1500,-,10000,0.0,0.4,1.0,0.0,0.0,5,0.0,0.0,OFF,OFF,Auto,OFF,OOOOOOOOOOOOOOOOOO

ADD3 IR,500,+,0.00,0.10,1.0,2.0,3.0,4.0,3.500,OOOOOOOOOOOOOOOOOO

### 13 400/800 Hz Hipot Output

Perform ACW test at 400Hz or 800Hz.

### 15 DCW 6kV/50mA with Discharge Circuit (model 7800 only)

This option adds increased current capacity for the DCW test along with a discharge circuit to ensure proper discharge of energy. With this option the current capacity goes up to 50mA. This option is only available on model 7800. This option allows for testing capacitive loads up to 1200uF. Ramp times must be carefully adjusted to ensure proper function of the test with this option.

We recommend the following formula to calculate the minimum Ramp times for testing: Ramp Time = C\*V/I (Where C is the DUT capacitance in micro-Farads, V is the test voltage, and I is the current. For example: DUT Capacitance = 100uF, Test Voltage = 1000V Ramp Time = (100uF)\*(1000V)/50mA = 2seconds \*The above is a suggestion and some test applications may require the Ramp times to be raised as appropriate. The table below shows the specifications that apply when this option is installed:

DCW 6kV/50mA with Discharge Circuit			
Output Voltage, DCV	0 - (6000)	1	± (1.5% of setting + 5V)
DC Output Ripple	<4 % {6KV/50mA at Capacitive Load}		
SETTINGS			
Auto Range			
HI and LO-Limit, current, uA	0.0000-0.9999	0.0001	± (2% of setting + 10 counts) Low Range is ON.
	1.000 - 9.999	0.001	
	10.00 - 99.99	0.01	
	100.0 - 999.9, Low range = ON 0.0 - 999.9, Low range = OFF	0.1	± (2% of setting + 2 counts)
	1000 - 50000	1	
Ramp-Up Timer, second	0.4 - 999.9	0.1	± (0.1% + 0.05 sec)
Ramp-Down Timer, second	0.0, 1.0-999.9		
Dwell Timer, second	0, 0.4 - 999.9, (0=continuous) and 0, 1.0 - 999.9 when it be selected low current. range.		
Ramp-HI, current, uA	0.0000-0.9999	0.0001	± (2% of setting + 10 counts) Low Range is ON.
	1.000 - 9.999	0.001	
	10.00 - 99.99	0.01	
	100.0 - 999.9	0.1	± (2% of setting + 2 counts)
	1000 - 50000	1	
Charge-LO, current	0.0 - 350.0 µA DC or Auto Set, when current range is 3 ranges. 0.00 - 35.00 uA DC or Auto Set, when current range is 6 ranges.		
Discharge Time	< 50 msec for no load		
Maximum Capacitive Load	≤ 1200uF		
Ground Continuity Current	Current: DC 0.1 A ± 0.01A, fixed		
	Max. Ground Resistance: 1.0 Ω ± 0.1Ω		
Current Offset	0.0 - 50000uA *(Total current + current offset =<50mA)		
Fixed Range			
DC Current, µA	0.0000 - 0.3500	0.0001	± (2% of setting + 10 counts) Low Range is ON.
	0.351 -3.500	0.001	
	3.51 - 35.00	0.01	
	35.1 - 350.0, Low range = ON 0.0 - 350.0, Low range = OFF	0.1	± (2% of setting + 2 counts)
	351 – 3500	1	
	3501 - 50000	1	

MEASUREMENT			
Voltage, KV(DC)	0.00- (6.00)	0.01	± (1.5% of reading +1 count)
Accuracy for AUTO range			
DC Current, nA	0.0 - 400.0 (0.000 - 565.7 Peak)	0.1	± (2% of setting + 10 counts) Low Range is ON.
DC Current, µA	0.350 - 4.000 (0.380 - 5.657 Peak)	0.001	
	3.50 - 40.00 (3.80 - 56.57 Peak)	0.01	
DC Current, mA	35.0 - 400.0, Low Range = ON (38.0 - 565.7 Peak) 0.0 - 400.0, Low Range = OFF (0.0 - 565.7 Peak)	0.1	± (2% of reading + 2 counts)
	0.300 – 4.000 (0.424 - 5.657 Peak)	0.001	
	3.50 - 10.00 (3.80 - 14.14 Peak)	0.01	
Accuracy for Fixed range			
DC Current, nA	0.0 - 350.0	0.1	± (2% of setting + 10 counts) Low Range is ON.
DC Current, µA	0.000 -3.500	0.001	± (2% of setting + 10 counts) Low Range is ON Additional error when reading < 6% of range.
	0.00 - 35.00	0.01	
	00.0 - 350.0	0.1	± (2% of reading + 2 counts)
DC Current, mA	0.000 – 3.500	0.001	± (2% of reading + 2 counts) Additional error when reading < 6% of range.
			± (0.1% of range)
	0.00 - 50.00	0.01	± (2% of reading + 2 counts) Additional error when reading < 6% of range. ± (0.2% of range)

## 16 Advanced ARC Detection

This option adds the 10-30kHz and 10-150kHz frequency selection for the Arc Detection function. It is user selectable in the menu.

# Appendix D - Remote BUS Interface:

This section provides information on the proper use and configuration of the bus remote interface. The USB/RS-232 remote interface is standard on the HypotULTRA but the GPIB (IEEE-488) or ENET interface option can be substituted for the USB/RS-232 interface. Please refer to Options for details on the HypotULTRA options. The USB/RS232, ENET interface uses the same command set as the GPIB interface for setting test parameters; however, many functions of the GPIB 488.2 interface are not available through USB/RS-232/ENET. The IEEE-488 interface included with the HypotULTRA conforms to the requirements of the IEEE-488.2 standard.

The USB/RS-232 interface card requires you to download a driver in order for the instrument to recognize the USB interface. The driver can be found on the Associated Research website:

<http://www.arisafety.com/products/software/USB-driver.aspx>

Click on "USB/RS-232 Driver" to download the driver. This link contains an automatic extract and install program. Follow the instructions of the installation program to initialize the driver install. NOTE: The USB port acts as a USB to RS-232 converter. As a result, the PC will recognize the USB port as a virtual COM port.

## USB/RS-232 Interface

This interface provides all of the control commands and parameter setting commands of the GPIB interface with the exception of some of the 488.2 Common Commands and SRQ capability. All commands can be found in USB/RS-232/GPIB/ENET Command List. The identification command \*IDN and the Status Reporting commands are also available through USB/RS-232/ENET.

### RS-232 Connector

The RS-232 cabling should be configured as follows for a 9-pin serial port interface:

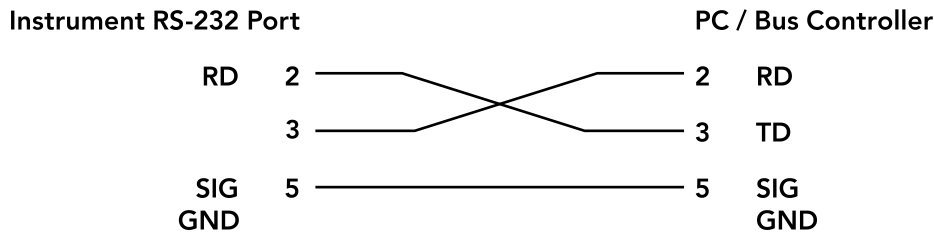

### Communications Port Configuration

The COM port should have the following configuration:

- 38400 baud
- 8 data bits
- 1 stop bit
- No parity

This interface does not support XON/XOFF protocol or any hardware handshaking. The controller should be configured to ignore the handshaking lines DTR (pin 4), DSR (pin 6) CTS (pin 8) and RTS (pin 7). If the port cannot be configured through software to ignore these lines the handshake lines should be jumpered together in two different sets. Pins 4 and 6 should be jumpered together and pins 7 and 8 should be jumpered together at the controller end of the cable.

## Disconnect Communication Icon

Once the communication to the instrument is established the front panel touch screen operations will be restricted and a new icon will appear on the bottom right of the screen. To regain access to the front panel touch screen, first stop any active communication from a PC and next touch the Disconnect RS-232/ENET/GPIB icon. This icon will reappear if there is an active communication via the USB/RS-232/ENET/GPIB port.

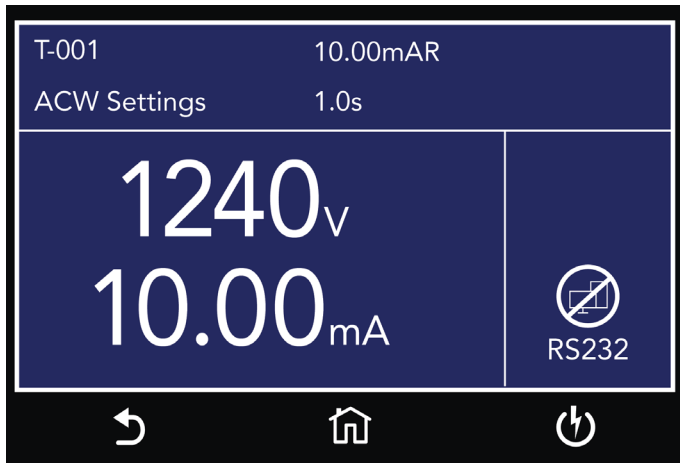

## Sending and Receiving Commands

### Sending Data

Once a command is sent to the instrument over the USB/RS-232/ENET bus the instrument will send one of two responses. If the transfer was recognized and completed the instrument will return with 06 hex or 6 decimal, the Acknowledge (ACK) ASCII control code. If there is an error with the command string that is sent, the instrument will respond with 15 hex or 21 decimal, the Not Acknowledge (NAK) ASCII control code. The ACK or NAK response allows for software handshaking to monitor and control data flow.

### Receiving Data

When requesting data from the instrument it will automatically send the data back to the controller input buffer. The controller input buffer will accumulate data being sent from the instrument, including the ACK and NAK response strings, until it has been read by the controller.

## GPIB Interface

### GPIB Connector

Connection is usually accomplished with a 24-conductor cable with a plug on one end and a connector at the other end. Devices may be connected in a linear, star or a combination configuration.

The standard connector is the Amphenol or Cinch Series 57 Microribbon or AMP CHAMP type. The GPIB uses negative logic with standard transistor-transistor logic (TTL) levels. When DAV is true, for example, it is a TTL low level ( $\leq 0.8$  V), and when DAV is false, it is a TTL high level ( $\geq 2.0$  V).

### Restrictions and Limitations on the GPIB

- A maximum separation of 4 m between any two devices and an average separation of 2 m over the entire bus.
- A maximum total cable length of 20 m.
- No more than 15 device loads connected to each bus, with no less than two-thirds powered on. For example 1 GPIB controller and a maximum of 14 GPIB instruments.

**NOTE:** A bus extender, which is available from numerous manufacturers, is available to overcome these limitations.

### GPIB Address

Each device on the GPIB (IEEE-488) interface must have a unique address. You can set the address of the HypotULTRA to any value between 0 and 30. The address can only be set from the front panel. The address is stored in non-volatile memory and does not change when the power has been off or after a remote reset.

- The address is set to 8 when the instrument is shipped from the factory.

### Interface Functions

The capability of a device connected to the bus is specified by its interface functions. These functions provide the means for a device to receive, process, and send messages over the bus. The interface functions are listed in the chart on the next page.



## GPIB 488.1 Interface Functions

INTERFACE FUNCTION	SUBSET	DESCRIPTION
Source Handshake	SH1	Complete Source handshake capability
Acceptor Handshake	AH1	Complete Acceptor handshake capability
Talker	T6	Talker functions (unaddress if MLA)
Listener	L4	Listener functions (unaddress if MTA)
Service Request	SR1	Complete Service request capability
Remote Local	RL0	No remote/local capability
Parallel Poll	PP0	No parallel poll capability
Device Clear	DC1	Complete Device clear capability
Device Trigger	DT0	No device trigger capability
Controller	C0	No controller capability
Electrical Interface	E2	Three-state drivers
Controllable Items	Test and Reset control	
	Setting of test parameters for tests	
	Reading of instrument status and test results	
Data Codes	ASCII	
Delimiter	NL (+ EOI)	

## USB/RS-232/GPIB/ENET Interface Command List

### USB/RS-232 Responses

The USB/RS-232/ENET bus will automatically send any response back to the controller's input buffer.

### GPIB Queries and Responses

The HypotULTRA GPIB bus will not send any data to the controller without being queried. A GPIB read command must be sent after a command string to retrieve any data from a query command (?).

### Rules for Sending Commands to the Instrument

The following conventions are used to describe the commands syntax for HypotULTRA:

- Braces ( { } ) enclose each parameter for a command string.
- Triangle brackets ( < > ) indicate that you must substitute a value for the enclosed parameter.
- The Pipe ( | ) is used to separate different parameter options for a command.
- The command and the parameter data must be separated with a space.
- Each command string should be terminated by the ASCII control code, New Line (NL), (OAh) or the end of line (EOL) message for GPIB.
- All commands that end with a question mark (?) are query commands and required an IEEE-488 read command to retrieve the data from the device's output buffer.

## Test Execution Commands

The following commands are used to control actual output voltage and current from the instrument. Please observe all safety precautions.

COMMAND	DESCRIPTION
TEST	Execute a Test
RESET	Abort a test in Process or Reset Failures
SAO	Set Auto-Offset
SACG	Set Auto-Charge-LO

### TEST

Starts the test sequence at the selected step loaded into memory (RAM).

### RESET

Stop or abort a test. Also used to reset a latched failure condition.

### SAO

Set the offset for the Continuity test. The cables and any test fixture should be connected before executing the command. This command will perform an actual test and all safety precautions should be observed when using this command.

### SACG

Set the Charge-LO parameter for the DCW or IR test. The cables and any test fixture should be connected before executing the command. The test parameters that are set for the step will be used when performing the auto setting. This command will perform an actual test and all safety precautions should be observed when using this command.

## File Editing Commands

The following commands are used to create or modify Test Setup Files.

- Commands should be separated from parameters by a space.
- If multiple parameters are entered, they should be separated by commas.

COMMAND	DESCRIPTION	VALUE
FL <memory number>	File Load	memory number = 001-2000
FN nn,xxxx	File Name	nn=01-2000, xxxx=name (Max 8 Characters)
FD	File Delete	Current file in use
FD nn	File Delete nn	nn=1-2000
FS	File Save	Current file in use
FSA nn,xxxx	File Save As	nn=1-2000, xx=Name
FT?	File Total	
ST?	Step Total	
SS <step number>	Step Select step number	step number = 1-30
SS?	Step Select ?	
SAA	Step Add ACW test	
SAD	Step Add DCW test	
SAI	Step Add IR test	
SAC	Step Add CONT test	
SAG	Step Add GB Test	
ADD2 <n,p1,p2,p3...>	Add all parameters of a test step	n=test type, p=parameters
SD	Step Delete current	
SD nn	Step Delete nn	nn=01-200
SP <prompt mes-sage>	Step Prompt Create	Prompt message = Valid ASCII (1) Maximum 32 characters
SP	Step Prompt Delete	
LP?	List Prompt	
LP nn	List Prompt current	

(1) "Valid ASCII" is the character set that is available from the front panel LCD user interface. Consisting of upper case alphabet (A-Z), numbers (0-9) and decimal point (.), asterisk (\*), dash (-), under bar (\_), tilde (~) and space (SP).

#### **FL <file location>**

Load a file by file number from non-volatile memory into random access memory RAM.

#### **FN <file name>**

Creates a new file name for the active memory loaded into RAM.

#### **SS <step number>**

Selects the active selected step to load into RAM. The step must first be selected before any specific parameters can be edited.

#### **SAA, SAD, SAI, SAC, SAG**

These commands add the appropriate test type within the test file at the step location that has been selected.

#### **ADD2 <n, p1,p2,p3...>**

This command adds a step with all parameters to the current file. See the command summary tables below to see the specific test type for each of these commands.

The parameter <n> indicates the test type. The values ACW, DCW, IR, GND, or CONT. must be used. The parameters <p1,p2> etc. indicate the individual settings for each parameter of the test. All parameters must be included with the command and should appear in the same order that is shown in the table below. Also, like the individual parameter editing commands, the unit should not be included with the value; only the numeric value should be included in the command string. When the scanners are being used they should be appended to the end of the string, with the internal scanner first if installed, followed by the external scanner if connected to the rear panel scanner control port.

The list of parameters can also be found in the default parameters section of the manual, or refer to Test Parameter Editing Commands and Companion Queries for the proper values.

The parameter values for file editing commands should use complete text (i.e. "ON" and "OFF" or "Real" and "Total") and not use the coded values that are associated with the test parameter setting commands discussed in Test Parameter Editing Commands and Companion Queries. The LS2? companion command will also list all parameters in complete text in the order as they appear in the following table, preceded by the step number. The following table shows examples of the ADD2 and LS2 commands:

#### **ADD2 all parameters for one STEP**

ADD2 ACW,Voltage,HI-Limit T,LO-Limit T,Ramp Up,Dwell Time,Ramp Down,Arc Sense,HI-Limit R,LO-Limit R,Offset(NOT EDIT-ABLE must be 0),Frequency,Arc Detect,Continuity,Range,Scanner Setup

ADD2 DCW,Voltage,HI-Limit,LO-Limit,Ramp Up,Dwell Time,Ramp Down,Charge LO,Arc Sense,Offset,Ramp-HI,Arc Detect,-Continuity, Range,Low Range,Scanner Setup

ADD2 DCW-,Voltage,HI-Limit,LO-Limit,Ramp Up,Dwell Time,Ramp Down,Charge LO,Arc Sense,Offset,Ramp-HI,Arc Detect,-Continuity, Range,Low Range,Scanner Setup

ADD2 IR,Voltage,HI-Limit,LO-Limit,Ramp UP,Delay Time,Dwell Time,Ramp Down,Charge LO,Scanner Setup

ADD2 CONT.,HI-Limit,LO-Limit,Dwell Time,Offset,Scanner Setup

ADD2 GND ,Current,Voltage,HI-Limit,LO-Limit,HI-Limit V,LO-Limit V,Dwell Time,Offset,Offset V,Frequency,Scanner Channel

## LS2? & LS2 nn? Response Data format

Step number,ACW,Voltage,HI-Limit T,LO-Limit T,Ramp UP,Dwell, Ramp Down,Arc Sense,HI-Limit R,LO-Limit R,Offset,Frequency,Arc Detect,Continuity,Range,Scanner Setup

Step number,DCW,Voltage,HI-Limit,LO-Limit,Ramp Up,Dwell Time, Ramp Down,Charge LO,Arc Sense,Offset,Ramp-HI, Arc Detect,Continuity,Range,Low Range,Scanner Setup

Step number,-DCW,-Voltage,-Hi-Limit,-LO-Limit,Ramp Up,Dwell Time, Ramp Down,-Charge LO,Arc Sense,Offset,-Ramp-HI,Arc Detect,Continuity,Range,Low Range,Scanner Setup

Step number, IR,Voltage,HI-Limit,LO-Limit,Ramp UP,Delay Time, Dwell Time,Ramp Down,Charge LO,Scanner Setup

Step number,CONT.,HI-Limit,LO-Limit,Dwell Time,Offset, Scanner Setup

Step number,CONT,HI-Limit,LO-Limit,Delay,Offset,Scanner Setup

Step number,GND,Current,Voltage,HI-Limit,LO-Limit,HI-Limit V,LO-Limit V,Dwell Time,Offset,Offset V,Frequency,Scanner Channel

	ACW	DCW	-DCW	IR	CONT	GND
1	Voltage	Voltage	-Voltage	Voltage	Max-Limit	Current
2	HI-Limit Total	HI-Limit	-HI-Limit*	HI-Limit	Min-Lmt	Voltage
3	LO-Limit Total	LO-Limit	-LO-Limit	LO-Limit	Dwell	HI-Limit
4	Ramp Up	Ramp Up	Ramp Up	Ramp Up	Offset	LO-Limit
5	Dwell Time	Dwell Time	Dwell Time	Delay Time	Internal Scanner (opt)	HI-Limit V
6	Ramp Down	Ramp Down	Ramp Down	Ramp Down	External Scanner (opt)	LO-Limit V
7	Arc Sense	Charge-LO	-Charge-LO*	Charge-LO		Dwell Time
8	HI-Limit Real	Arc Sense	Arc Sense	Internal Scanner (opt)		Offset
9	LO-Limit Real	Ramp-HI	-Ramp-HI*	External Scanner (opt)		Offset V
10	Offset (Not Editable) (0)	Arc Detect (ON/OFF)	Arc Detect (ON/OFF)			Frequency
11	Frequency (50/60)	Continuity (ON/OFF)	Continuity (ON/OFF)			External Scanner 1 (opt)
12	Arc Detect (ON/OFF)	Internal Scanner (opt)	Internal Scanner (opt)			External Scanner 2 (opt)
13	Continuity (ON/OFF)	External Scanner (opt)	External Scanner (opt)			
14	Range (AUTO/FIXED)					
15	Internal Scanner (opt)					
16	External Scanner (opt)					

\*Use negative symbol (-) for non-zero values in -DCW mode.

## ADD2 Command String Examples

Use the following ADD2 command string to setup a corresponding test with the listed parameters. The command string below can be copied exactly as it appears. The parameters can be edited and sent to the tester via BUS command. When the scanners are being used they should be appended to the end of the string, with the internal scanner first if installed, followed by the external scanner if connected to the rear panel scanner control port.

### ACW Test

Test	Voltage	Hi-Limit T	LO-Limit T	Ramp Up	Dwell Time	Ramp Down	Arc Sense	Hi-Limit R	LO-Limit R	Offset (Not Editable)	Frequency	Arc Detect	Continuity	Range
ACW	1240	10.00	0.000	0.1	1.0	0.0	5	10.00	0.000	0.000	60	OFF	OFF	Auto

ADD2 ACW,1240,10.00,0.000,0.1,1.0,0.0,5,10.00,0.000,0.000,60,OFF,OFF,Auto

### DCW Test

Test	Voltage	Hi-Limit	LO-Limit	Ramp Up	Dwell Time	Ramp Down	Charge LO	Arc Sense	Offset	Ramp-Hi	Arc Detect	Continuity	Range	Low Range
DCW	1500	10000	0.0	0.4	1.0	0.0	0.0	5	0.0	0.0	OFF	OFF	AUTO	OFF

ADD2 DCW,1500,10000,0.0,0.4,1.0,0.0,0.0,5,0.0,0.0,OFF,OFF,Auto,OFF

### -DCW Test

Test	Voltage	Hi-Limit	LO-Limit	Ramp Up	Dwell Time	Ramp Down	Charge LO	Arc Sense	Offset	Ramp-Hi	Arc Detect	Continuity	Range	Low Range
DCW	1500	-10000	0.0	0.4	1.0	0.0	0.0	5	0.0	0.0	OFF	OFF	AUTO	OFF

ADD2 -DCW,-1500,-10000,0.0,0.4,1.0,0.0,0.0,5,0.0,0.0,OFF,OFF,Auto,OFF

Continued on next page →

### Insulation Resistance

Test	Voltage	Hi-Limit	Lo-Limit	Ramp Up	Delay Time	Dwell Time	Ramp Down	Charge-LO
IR	500	0.00	0.10	0.1	0.5	0.5	0.0	0.000

ADD2 IR,500,0.00,0.10,0.1,0.5,0.5,0.0,0.000

### Continuity Test

Test	Max-Lmt	Min-Lmt	Dwell Time	Offset
CONT.	1000	0.000	1.0	0.00

ADD2 CONT.,1000,0.000,1.0,0.00

### Ground Bond

Test	Current	Voltage	HI-Limit	LO-Limit	HI-Limit V	LO-Limit V	Dwell Time	Offset	Offset V	Frequency
GND	35.00	8.00	100	0	6.00	0.00	1.0	0	0.00	60

ADD2 GND,35.00,8.00,100,0,6.00,0.00,1.0,0,0.00,60

**SP <prompt message>**

Adds or edits a prompt message for the active step.

**SP**

Removes or deletes the prompt that had been created for the active step.

**Test Parameter Editing Commands and Companion Queries**

These commands are used to modify the test parameter within each step. These commands require a parameter value to be included with the command. The companion query command will read the parameter. The writing of the parameter requires that the unit not be included with the value, only the numeric value should be included with the command. Also, when the query commands are used the response will not include the unit's characters. Many of the commands will function the same way for multiple test types; however, the input range may be different and therefore used a different possible set of values.

COMMAND	NAME	TEST TYPES	VALUE
ECC {1 0} ECC?	Edit Connect	ALL	1= On, 0=Off
ED {1 0} ED?	Edit Current Meter Display	ACW	1 = Real, 0 = Total
EV <value> EV?	Edit Voltage	ACW DCW IR	0 - 5000V 0 - 6000V 10 - 6000V
EC nnnn EC?	Edit Current	GB	0 – 40A
ECG < value > ECG?	Edit Charge-Lo	DCW IR	0.0 - 350.0uA 0.000 - 3.500uA
ECT {1 0} ECT?	Edit Continuity	ACW DCW	1= On, 0=Off
ERU < value> ERU?	Edit Ramp-Up	ACW DCW IR	0.1 - 999.9s 0.4 - 999.9s 0.1 - 999.9s
ERD <value > ERD?	Edit Ramp-Down	ACW DCW IR	0.0 - 999.9s 0, 1.0 - 999.9s 0, 1.0 - 999.9s
ERH n ERH?	Edit Ramp-Hi n	DCW	n=0-10000uA
EDW < value > EDW?	Edit Dwell	ACW DCW IR GND CONT	0, 0.2 - 999.9s 0, 0.4 - 999.9s 0, 0.5 - 999.9s 0, 0.5 - 999.9s 0, 0.4 - 999.9s
EDE < value > EDE?	Edit Delay	IR	0.5 – 999.9s
EO < value > EO?	Edit Offset	CONT DCW GND	0.0 - 10.00Ω 0.0 - 10000uA 0 - 200mΩ
EOV nnnn EOV?	Edit Offset	GB	1 - 6V
EA < value > EA?	Edit Arc	ACW DCW	1 - 9
EAD {1 0} EAD?	Edit Arc-Detect	ACW DCW	1= On, 0=Off

Continued on next page →



EHT < value > EHT?	Edit Hi-Lmt-T	ACW	0.000 - 30.00mA
EHR < value > EHR?	Edit HI-Limit-R	ACW	0.000 - 30.00mA
EH < value > EH?	Edit HI-Limit	DCW IR CONT	0.0 - 20000uA 0, 0.1 - 50000M Ohms 0, 0.00 - 10000 Ohms
ELT < value > ELT?	Edit LO-Limit-T	ACW	0.000 - 30.00mA
ELR < value > ELR?	Edit LO-Limit-R	ACW	0.000 - 30.00mA
EL < value > EL?	Edit Min-Lmt / LO-Limit	DCW IR CONT	0.0 - 20000uA 0.1 - 50000M Ohms 0.0 - 10000 Ohms
EF n EF?	Edit Frequency	ACW	n=0-3, 0=50Hz, 1=60Hz, 2=400Hz, 3=800Hz
ES xxxxxxxx.... ES?	Edit Scanner-HLO xxxx	All	xxxxxxx=H,L,O
ERG n ERG?	Edit Range	ACW DCW	n=0-1 0=Auto, 1=Fixed
ELG n ELG?	Edit Low Range	DCW	n=0-1 0=Off, 1=On
EHV nnnn EHV?	Edit Voltage Hi Lmt	GB	0.00 – 6.00V, 0=OFF
ELV nnnn ELV?	Edit Voltage Lo Lmt	GB	0.00 – 6.00V

### System Parameter Editing Commands and Companion Queries

These commands are used to modify the system parameters for the instrument. These commands require a parameter value to be included with the command. The companion query command will read the parameter using the same value that is used for setting the parameter.

COMMAND	NAME	VALUE
SPR {1 0} SPR?	PLC Remote	1= On, 0=Off
SSI {1 0} SSI?	Single Step	1= On, 0=Off
SF {1 0} SF?	Fail Stop	1= On, 0=Off
SAL < value > SAL?	Alarm Volume	0-9
SL {1 0} SL?	Lock	1= On, 0=Off
SML {1 0} SML?	Memory Lock	1= On, 0=Off
SSG2 n SSG2?	Smart GFI	n=0, or 0.4 - 5mA
SR {2 1 0} SR?	Results	0=LAST, 1=ALL, 2=P/F

Continued on next page →

COMMAND	NAME	VALUE
SCA {1 0} SCA?	Cal Alert	1= On, 0=Off
SCDA < value > SCDA?	Cal Date	mm,dd,yy or yy,mm,dd or dd,mm,yy according to SDF setting
SCDU < value > SCDU?	Cal Due	mm,dd,yy or yy,mm,dd or dd,mm,yy according to SDF setting
SA < value > SA?	Alert Date	mm,dd,yy or yy,mm,dd or dd,mm,yy according to SDF setting
SDT < value > SDT?	System Date	mm,dd,yy or yy,mm,dd or dd,mm,yy according to SDF setting
SDF < value > SDF?	Date Format	0=yy,mm,dd, 1=mm,dd,yy, 2=dd,mm,yy
STM < value > STM?	Time	hh,mm (24hr) hh,mm,AM or hh,mm,PM (12hr) according to STF setting
STF {1 0} STF?	Time Format	0=12hr, 1=24hr
SPID nnnnnnn SPID?	Device ID	0 - 9999999
SPD n SPD?	System Display ID	n=0-1 0=Off, 1=On
SPM {2 1 0} SPM?	Print Mode	0=AUTO, 1=MANUAL, 2=OFF
SPRE {1 0} SPRE?	Prn Result n	n=0-1 0=FAIL, 1=ALL
SPS {1 0} SPS?	Prn Setting n	1= On, 0=Off
SFF {1 0} SFF?	Form Feed n	1= On, 0=Off
SIS	Import System	
SIF xxxxxxxx	Import File	xxx=name
SRF?	Read USB.HU4 File	
SES	Export System	
SEF n	Export File	n=001-2000
SMM n SMM?	Home Screen	n=0-2, 0=Perform Tests, 1=Menu, 2=My Menu
SAN n SAN?	Animation	n=0-1 0=Continue, 1=Pause
SLA n SLA?	Language	n=0-7, 0=English, 1=Traditional Chinese 2=Simplified Chinese, 3=Spanish 4=Portuguese, 5=Turkish 6=German, 7=French
SCS n SCS?	Color Style	n=0-2 0=White, 1=Black, 2=Blue

Continued on next page →

COMMAND	NAME	VALUE
SAV n SAV?	Auto Save	n=0-1 0=Off, 1=On
STS n STS?	Touch Sound	n=0-1 0=Off, 1=On
SHK n SHK?	Hardware Key	n=0-1 0=Off, 1=On
SPV n SPV?	ProVOLT	n=0-1 0=Off, 1=On
SGP n SGP?	GPIB Address	n=0-30
SDUT n SDUT?	Dual Test	n=0-1 0=Off, 1=On
SRS n SRS?	Result Save	n=0-1 0=Internal memory, 1=USB Disk
SDER	Delete All Int Memory Results data	
STR n STR?	Test Results	n=0-3 0=None, 1=Fail, 2=Pass, 3=All
SRL n	Results Limit	n=0-100000
SRL?		
STL n STL?	Time Limit	n=0-99
SRN xxxxxxxx SRN?	Results Name	xxx=name
SUL n?	User	n=0-5 Name, Password, Level
SUA p,p,p,p	User Add	SUA Pointer,Name,Password,Level Pointer: 1-5 Name: 8 character max Password: 8 number max Level: 0=Run Only, 1=Recall Setup, 2=Edit Step, 3=Full System
SUD n	User Delete	n=1-5
SUE p,p,p,p	User Edit	SUA Pointer,Name,Password,Level Pointer: 1-5 Name: 8 character max Password: 8 number max Level: 0=Run Only, 1=Recall Setup, 2=Edit Step, 3=Full System
SM n SM?	Measurement	n=0-1 0=True RMS, 1=Average
SBI n SBI?	Barcode IP Format	n=0, 5-10 0=Off, 5=PROD CHEK/SER, 6=PROD/SER, 7=PRODUCT, 8=SERIAL, 9=PROD/SER1/SER2, 10=PROD one/SER
SAS n SAS?	Auto Start Format	n=0-1 0=Off, 1=On

## Query Commands

These query commands will retrieve data from the instrument. The GPIB bus application requires an IEEE-488 read command to be sent after the query command. These commands include functions for retrieving test data, test results and remote hardware status, as well as setup file information.

COMMAND	NAME	VALUE
TD?	List Testing Data	Test In Process
STD?	List Testing Data	ON/OFF
RDM?	Read Max Current	ACW: Last Total Current, Last Real Current, Total I-max, Real I-max DCW: Last Current, I-max
RD <step number>?	List Results Data	step number = 1-200
RR?	Read Remote Reset	1=Open, 0=Closed
RI?	Read Remote Interlock	1=Open, 0=Closed
RS?	Read Scanner Status	0=None, 1=Int, 2=Ext 1, 3=Int+Ext 1, 4=Ext 2, 6=Ext 1+Ext 2
RU?	Read USB Stick	0=NO, 1=YES
LF?	List File Name	Active selected memory
LF nn?	List File Name	Active selected file
LP?	List Prompt	Active selected Step
LP <step number>?	List Prompt by step number	Step number = 1-200
LS2?	List Step Parameters	
LS2 <step number>?	List Step Parameters by step number	Step number = 1-200

### TD? or STD?

Read the active data being displayed on the LCD display while the test is in process. Also read the last data taken when the test sequence has completed. Each parameter is separated by commas and includes step number, test type, test status, and metering. The syntax for this command response is {step, test type, status, meter 1, meter 2, meter 3}. ACW test displays 4 meters. Each meter will contain only the value and not the units. In the case of DCW current where both uA and mA are used on the display, the command response will always indicate the current in uA for example 2.0mA will respond with 2000 for 2000uA.

### RD <step number>?

Read the results for an individual step. The step number is the actual step number that has been saved within the file, not the order of which the steps were executed. For example if the test was executed starting from step 3 and ending with step 5 then the first step test results will be found in location 3 not in location 1. Each parameter is separated by commas and includes step number, test type, test status, and metering. The syntax for this command response is {step, test type, status, meter 1, meter 2, meter 3}. ACW test displays 4 meters. Each meter will contain only the value and not the units. In the case of DCW current where both uA and mA are used on the display the command response will always indicate the current in uA for example 2.0mA will respond with 2000 for 2000uA.

## Ground Bond

Step Number	Test Type	Status	Meter 1 - Current (A)	Meter 2 - Resistance (mΩ)	Meter 3 - Voltage (V)	Meter 4 - Timer (s)
01	GND	PASS	0.00	>200	0.00	1.0

01,GND,PASS,0.00,>200,0.00,1.0

## Insulation Resistance

Step Number	Test Type	Status	Meter 1 - Voltage DC (V)	Meter 2 - Resistance (mΩ)	Meter 3 - Timer (s)
02	IR	PASS	500	>50000	0.5

02,IR,PASS,500,>50000,0.5

## Continuity Test

Step Number	Test Type	Status	Meter 1 - Resistance (Ω)	Meter 2 - Timer (s)
03	CONT.	MAX-LIMIT	>10000	0.4

03,CONT.,MAX-LIMIT,>10000,0.4

## DCW Test

Step Number	Test Type	Status	Meter 1 - Resistance (Ω)	Meter 2 - Timer (s)	Meter 3 - Timer (s)
04	DCW	PASS	1.50	0.0	1.0

04,DCW,PASS,1.50,0.0,1.0

## ACW Test

Step Number	Test Type	Status	Meter 1 - Voltage AC (kV)	Meter 2 - Current Total (mA)	Meter 3 - Current Real (mA)	Meter 4 - Timer (s)
05	ACW	PASS	1.24	0.001	0.000	1.0

05,ACW,PASS,1.24,0.001,0.000,1.0

## RR?

Read the remote Reset input signal. When the remote reset has been activated by closing the contacts the query will return a value of 1 to indicate the instrument is being Reset.

## RI?

Read the remote Interlock input signal. When the remote Interlock has been activated by opening the contacts the query will return a value of 0 to indicate the instrument is in the Interlock state and will not be able to generate output voltage or current.

## RS?

**Read** Scanner Status command will respond with a value that identifies the number of scanners installed or connected to the instrument. Values 0 – 4 will indicate if there are no scanners connected, one Internal or External scanner, or if both an Internal and an External scanner are connected.

**LF?**  
Lists the file name of the memory loaded into active memory (RAM).

**LFN?**  
Lists the memory number of the active memory file loaded into active memory (RAM).

**LF <memory number>?**  
List the file name of any of the 50 memories.

**LP?**  
Lists the prompt that is created for the selected step within active memory (RAM).

**LP <step number>?**  
Lists the prompt that has been created for a particular step of the file within active memory (RAM).

**LS?**  
Lists all the parameters for the individual step that is currently selected. See the ADD command for the list of parameters. A comma (,) will separate each parameter and will be preceded with the step number.

**LS <step number>?**  
Lists all the parameters for the individual step indicated by step number = 1-30. See the ADD command for the list of parameters. A comma (,) will separate each parameter and will be preceded with the step number.

## IEEE 488.2 Common Commands

These commands are required by the IEEE-488.2 standard with the exception of \*PSC, \*PSC?. Most of these commands are not available over the USB/RS-232/ENET bus except for the \*IDN? command which can be used to retrieve the instrument identification information, and the four status reporting commands \*ESR?, \*ESE, \*ESE? and \*STB?.

COMMAND	NAME	VALUE
*IDN?	Identification Query	Associated Research Inc., Model Number, Serial Number, Firmware Revision
*RST	Reset Command	Resets HYPOTULTRA
*TST?	Self-Test Query	00H=OK 01H=TEST EEPROM ERROR
*CLS	Clear Status Command	Clear Standard Event Status Register Clear Service Request Register
*OPC	Operation Complete Command	When all selected pending operations complete, ESR BIT0=1
*OPC?	Operation Complete Query	When all selected pending operations complete, Output Queue=1
*WAI	Wait-to-Continue Command	
*PSC {1 0}	Power-on Status Clear Command	1 = Power-on clear enable registers 0 = Power-on load previous enable registers
*PSC?	Power-on Status Clear Query	
*ESR?	Standard Event Status Register Query	0 - 255
*ESE <value>	Standard Event Status Enable Command	Value = 0 - 255
*ESE?	Standard Event Status Enable Query	0 - 255
*STB?	Read Status Byte Query	Read Status Byte
*SRE <value>	Service Request Enable Command	Value = 0 - 255
*SRE?	Service Request Enable Query	0 - 255

**\*IDN?**

Read the instrument identification string. Company = Associated Research Inc.

**\*RST**

Reset the instrument to original power on configuration. Does not clear Enable register for Standard Summary Status or Standard Event Registers. Does not clear the output queue. Does not clear the power-on-status-clear flag.

**\*TST?**

Performs a self-test of the instrument data memory. Returns 0 if it is successful or 1 if the test fails.

**\*CLS**

Clears the Status Byte Summary register and Event registers. Does not clear the Enable registers.

**\*OPC**

Sets the operation complete bit (bit 0) in the Standard Event register after a command is completed successfully.

**\*OPC?**

Returns an ASCII "1" after the command is executed.

**\*WAI**

After the command is executed, it prevents the instrument from executing any further query or commands until the no-operation-pending flag is TRUE.

**\*PSC {1|0}**

Sets the power-on status clear bit. When set to 1 the Standard Event Enable register and Status Byte Enable registers will be cleared when power is turned ON. 0 setting indicates the Enable registers will be loaded with Enable register masks from non-volatile memory at power ON.

**\*PSC?**

Queries the power-on status clear setting. Returns 0 or 1.

**\*ESR?**

Queries the Standard Event register. Returns the decimal value of the binary-weighted sum of bits.

**\*ESE <value>**

Standard Event Enable register controls which bits will be logically OR'd together to generate the Event Summary bit 5 (ESB) within the Status Byte.

**\*ESE?**

Queries the Standard Event enable register. Returns the decimal value of the binary-weighted sum of bits.

**\*STB?**

Read the Status Byte. Returns the decimal value of the binary-weighted sum of bits.

**\*SRE <value>**

Service Request Enable register controls which bits from the Status Byte should be used to generate a service request when the bit value = 1.

**\*SRE?**

Queries the Service Request enable register. Returns the decimal value of binary-weighted sum of bits.





# Appendix E - Replacement Parts List

PART NUMBER	QTY.	REF. DESIGNATOR	DESCRIPTION
<b>Supplied Accessories</b>			
38793	2	—	2U Rack Mount Bracket
38794	2	—	2U Rack Mount Handle
38549	4	—	Screw for Rack Mount Handle
37780	1	—	Fuse 6.3A 250V Slow-Blow 20mm (7804/20/50)
37999	1	—	Fuse 15A 250V Fast-Blow 30mm (7800/54)
04040A-08	1	—	High Voltage Cable
39066	1	—	USB Cable AB-Type 1.8m
33189	1	—	Cable Input Cordset USA (7804/20/50)
38071	1	—	Cable Input Cordset USA (7800/54)
38075	1	—	Interlock Connector
36544	1	—	Adapter Box
38482	1	—	Adapter Box (7804/54)
02100A-13	2	—	Cable Assembly Return
38489	1	—	Cable Assembly High Current (7804/54)
38490	1	—	Cable Assembly Return (7804/54)
39598	1	—	LCD Protective Film
39571	1	—	8GB White USB Flash Drive
<b>Panel Components</b>			
38364	1	—	Fuse Holder 20mm(7804/20/50)
39274	1	—	Fuse Holder 30mm (7800/54)
37478	2	—	High Voltage Connector
35999	4	—	Return Connector
38487	2	—	Socket 80 Amp Red
38488	2	—	Socket 80 Amp Black
39606	1	—	Power Switch 4P/4A
37571	1	—	Earth Connector
37806	1	TEST	Test Switch Green Lighted
37807	1	RESET	Reset Switch Red Lighted
38101	1	—	Feet Kit w/o Rubber Inserts
38102	4	—	Rubber Insert for Feet
39572	1	—	Color LCD Touch Screen

PART NUMBER	QTY.	REF. DESIGNATOR	DESCRIPTION
39574	1	—	DC Fan
39575	1	—	Fan Grill
<b>PCB Assemblies</b>			
39594	1	AMPM001A	Amplifier Board (7820/50)
39616	1	AMPM001B	Amplifier Board (7800)
39593	1	ANGSB100	Analog Board
39587	1	CONM001	Main Control Board
39592	1	CNRSB100	Scanner Interface Board (7820/50)
39591	1	FLYM001	FLY Back Board
39590	1	HRYSB100	High Voltage Relay Board (7800/7850)
39904	1	HRYSB100	High Voltage Relay Board DC (7804/54)
39589	1	HVSB100C	High Voltage Board (7820/50)
39617	1	HVSB100D	High Voltage Board (7800)
39588	1	KEYSB100	Keypad Board
39618	1	LEDM001	High Voltage Indicator
39596	1	REMSB100	Remote Board
39597	1	URP-G	USB/RS232 Card
39595	1	USBSB100	USB/Barcode Board
39649	1	URP-H	Printer Interface Board
39650	1	CGP-03	GPIB Interface Board
39651	1	38818	Ethernet Card
39562	1	CSUSB100A	8 Port Scanner Assembly
39563	1	CSUSB100B	4 Port Scanner Assembly
<b>Internal Components</b>			
39652	1	T2	High Voltage Output Transformer (7820/50)
39636	1	T2	500VA Output Transformer (7800)
39897	1	T3	Ground Bond Transformer (7804/54)

# Appendix F – Calibration Procedure

## DID YOU KNOW?

This instrument has been fully calibrated at the factory in accordance to our published specifications and with standards traceable to the National Institute of Standards & Technology (NIST).

You will find in this manual a copy of the “Certificate of Calibration”. It is recommended that you have this instrument recertified at least once per year. Associated Research recommends you use “Calibration Standards” that are NIST traceable or traceable to agencies recognized by NIST to keep this instrument within published specifications. Unless necessary, do not recalibrate the instrument within the first 12 months.

End user metrology standards or practices may vary. These metrology standards determine the measurement uncertainty ratio of the calibration standards being used. Calibration adjustments can only be made in the Calibration mode and calibration checks or verifications can only be made while operating in Test mode.

**NOTE:** Verification should be performed before and after calibration. Calibration effects will only be noticeable after exiting calibration mode.

## Warranty Requirements

Associated Research offers a standard five year manufacturer’s warranty. In order to be eligible for the extended warranty instruments must be returned to Associated Research for certification service at least once every twelve months.

A return material authorization number (RMA) must be obtained from Associated Research before returning this instrument for calibration. To obtain an RMA number or for information regarding our warranty, please contact our customer support representatives at 1-800-858-TEST (8378) or setup an RMA online at <http://www.arisafety.com/support/rma-request/>

## Required Calibration Equipment

- 0 - 6 KV AC/DC Metered Voltage Divider
- 30 mA AC, 20 mA DC Ammeter
- 20VAC Voltmeter
- 40 AAC Current Shunt
- 1M, 0.25 watt resistor, 1000 volt
- 50M, 0.25 watt resistor, 1000 volt
- 1G, 0.25 watt resistor, 1000 volt
- 100K, 175 watt resistor, 5000 volt
- 200k ohm, 1000 volt 5 watt
- 1ohm 1 watt
- 10,100,1000,10000 ohm 0.25 watt resistors

## Calibration Initialization

Press and hold the calibration key on the rear panel with a pen, pencil, or small screwdriver while powering ON the HypotULTRA. The HypotULTRA enters calibration mode after the power on sequence is complete. When the calibration is initialized the calibration screen will display each calibration point and appear as follows:

1

01	ACW VOLT	04	DCW VOLT
05	ACW 30.00mA	06	ACW 3.500mA
09	DCW 9.99mA	10	DCW 3.500mA

2

11	DCW 350.0uA	12	DCW 35.00uA
13	DCW 3.500uA	14	DCW 350.0nA
15	GND 8.00V	16	GND 30.00A

3

17	CONT. OFFSET	18	CONT. 0.500Ω
19	CONT. 10.00Ω	20	CONT. 100.0Ω
21	CONT. 1000Ω	22	CONT. 10kΩ

4

23	GFI 5.0mA	Calibration Date 12/27/2016

From the Calibration screens, use the touchscreen to select the parameter you wish to calibrate. A calibration prompt screen will now appear that describes the necessary load and connection information for the parameter being calibrated.

Once you press TEST, the Calibration data entry screen will appear for the selected parameter. Read the measurement from your standard and enter it using the numeric keypad. Once a value is entered the screen for the next step will appear.

## Calibration Examples

### Calibration of AC Hipot Voltage

1

**Step1:**

Connect the standard 5kVAC voltmeter.

When the voltmeter is connected.  
Press TEST to start the calibration.  
Press RESET to cancel.



Follow on screen instruction to complete Step 1.

2

**Step2:**

Connect the standard 1kVAC voltmeter.

When the voltmeter is connected.  
Press TEST to start the calibration.  
Press RESET to cancel.



Follow on screen instruction to complete Step 2.

### Calibration of AC Hipot Voltage 400Hz (option 13 only)

1

**Step1:**

Connect the standard 5kVAC voltmeter.

When the voltmeter is connected.  
Press TEST to start the calibration.  
Press RESET to cancel.



Follow on screen instruction to complete Step 1.

2

**Step2:**

Connect the standard 1kVAC voltmeter.

When the voltmeter is connected.  
Press TEST to start the calibration.  
Press RESET to cancel.



Follow on screen instruction to complete Step 2.

### Calibration of AC Hipot Voltage 800Hz (option 13 only)

1

**Step1:**

Connect the standard 5kVAC voltmeter.

When the voltmeter is connected.  
Press TEST to start the calibration.  
Press RESET to cancel.



Follow on screen instruction to complete Step 1.

2

**Step2:**

Connect the standard 1kVAC voltmeter.

When the voltmeter is connected.  
Press TEST to start the calibration.  
Press RESET to cancel.



Follow on screen instruction to complete Step 2.

## Calibration of DC Hipot Voltage

1

**Step1:**

Connect the standard 5kVDC voltmeter.

When the voltmeter is connected.  
Press TEST to start the calibration.  
Press RESET to cancel.



Follow on screen instruction to complete Step 1.

2

**Step2:**

Connect the standard 1kVDC voltmeter.

When the voltmeter is connected.  
Press TEST to start the calibration.  
Press RESET to cancel.



Follow on screen instruction to complete Step 2.

3

**Step3:**

Connect the standard 100VDC voltmeter.

When the voltmeter is connected.  
Press TEST to start the calibration.  
Press RESET to cancel.



Follow on screen instruction to complete Step 3.

## Calibration of 30mA AC Total Current Range

1

Connect the 100k $\Omega$  load in series with  
30mAAC current meter.

When the load and meter are connected.  
Press TEST to start the calibration.  
Press RESET to cancel.



Follow on screen instruction to complete Step 3.

### Calibration of 3.5mA AC Total Current Range

1

Connect the 100k $\Omega$  load in series with 3.5mAAC current meter.

When the load and meter are connected.  
Press TEST to start the calibration.  
Press RESET to cancel.



Follow on screen instruction to complete this step.

### Calibration of 9.99mA DC Current Range

1

Step1:

Connect the 100k $\Omega$  current meter in series with 10mADC current meter.

When the load and meter are connected,  
Press TEST to start the calibration.  
Press Reset to cancel.



Follow on screen instruction to complete this step.

### Calibration of 3.500mA DC Current Range

1

Step1:

Connect the 100k $\Omega$  current meter in series with 3.5mADC current meter.

When the load and meter are connected,  
Press TEST to start the calibration.  
Press Reset to cancel.



Follow on screen instruction to complete this step.

### Calibration of 350uA DC Current Range

1

Step1:

Connect the 50M $\Omega$  current meter in series with 35uADC current meter.

When the load and meter are connected,  
Press TEST to start the calibration.  
Press Reset to cancel.



Follow on screen instruction to complete this step.

### Calibration of 35uA DC Current Range

1

Step1:

Connect the 50M $\Omega$  current meter in series with 3.5uADC current meter.

When the load and meter are connected,  
Press TEST to start the calibration.  
Press Reset to cancel.



Follow on screen instruction to complete this step.

### Calibration of 3.5uA DC Current Range

1

Connect the 100M $\Omega$  load in series with 3.5uADC current meter.

When the load and meter are connected.  
Press TEST to start the calibration.  
Press RESET to cancel.



Follow on screen instruction to complete this step.

## Calibration of 350nA DC Current Range

1

Connect the 1G $\Omega$  load in series with 350nADC current meter.

When the load and meter are connected.  
Press TEST to start the calibration.  
Press RESET to cancel.



Follow on screen instruction to complete this step.

## Calibration of GND Volts

1

Connect the standard 8.00VAC voltmeter

When the voltmeter is connected.  
Press TEST to start the calibration.  
Press RESET to cancel.



Follow on screen instruction to complete this step.

## Calibration of GND Current

1

Step 1:

Short the 30.00AAC load in series with current meter.

When the load and meter are connected.  
Press TEST to start the calibration.  
Press RESET to cancel.



Follow on screen instruction to complete Step 1.

2

Step 2:

Short the Current and Return leads together.

When the leads are shorted.  
Press TEST to start the calibration.  
Press RESET to cancel.



Follow on screen instruction to complete Step 2.



### Calibration of DC Continuity Offset

1

Short the CONT. Check and Return leads together.

When the leads are shorted.  
Press TEST to start the calibration.  
Press RESET to cancel.



Follow on screen instruction to complete this step.

### Calibration of DC Continuity 100Ω

1

Connect the standard 10Ω load from CONT. to Return.

When the standard load is connected.  
Press TEST to start the calibration.  
Press RESET to cancel.



Follow on screen instruction to complete this step.

### Calibration of DC Continuity 1Ω

1

Connect the standard 1Ω load from CONT. to Return.

When the standard load is connected.  
Press TEST to start the calibration.  
Press RESET to cancel.



Follow on screen instruction to complete this step.

### Calibration of DC Continuity 10KΩ

1

Connect the standard 10kΩ load from CONT. to Return.

When the standard load is connected.  
Press TEST to start the calibration.  
Press RESET to cancel.



Follow on screen instruction to complete this step.

### Calibration of DC Continuity 10Ω

1

Connect the standard 10Ω load from CONT. to Return.

When the standard load is connected.  
Press TEST to start the calibration.  
Press RESET to cancel.



Follow on screen instruction to complete this step.

1

**STEP1:**

Connect the standard 200k $\Omega$  with the 5mAAC standard current meter from H.V. to Chassis.  
When the load and meter are connected.  
Press TEST to start the calibration.  
Press RESET to cancel.



Follow on screen instruction to complete Step 1.

2

**STEP2:**

Connect the standard 200k $\Omega$  with the 5mADC standard current meter from H.V. to Chassis.  
When the load and meter are connected.  
Press TEST to start the calibration.  
Press RESET to cancel.



Follow on screen instruction to complete Step 2.