

Post with Guide marks

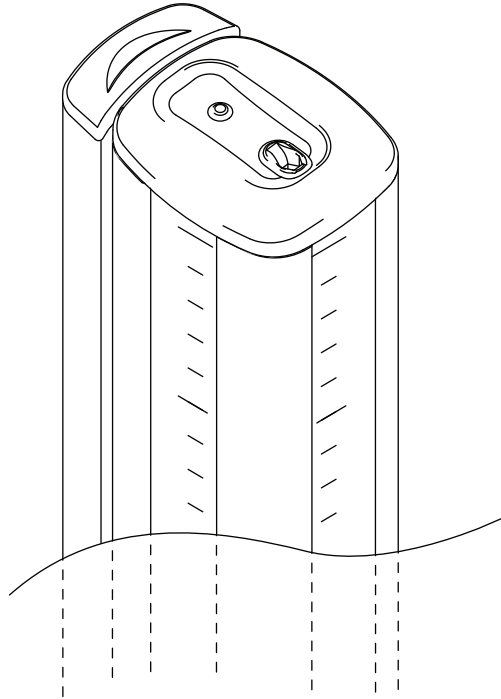

COMPONENT CHECKLIST

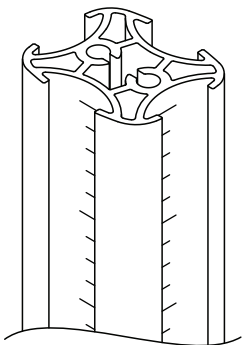

A
Post
(x1)

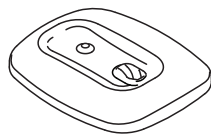

B
Post Cap
(x1)

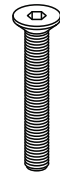

C
Screw
M8
(x2)



D
Cable Cover Cap
(x1)
(not supplied
with all posts)

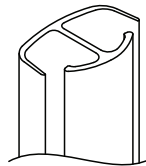

E
Cable Cover
(x1)
(not supplied
with all posts)



F
Cable clips
(not supplied
with all posts)

Desk 

REQUIRED TOOLS

- All tools provided

IMPORTANT INFORMATION

- ! Please ensure this product is installed as per these installation instructions.
- ! This product is compatible with Atdec AWM Series products.
- ! The manufacturer accepts no responsibility for incorrect installation.

1. Attach Post to fixing (fixing sold separately)

1.1 Follow the installation guide provided with your fixing to attach it to the post and fit it to the worksurface.

AWM Fixing options

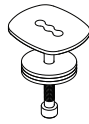
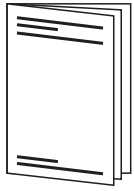

Bolt Through Kit
AWM-FB

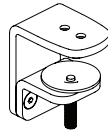

F Clamp
AWM-FF

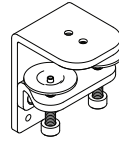

Heavy Duty F Clamp
AWM-FH

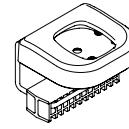

C Clamp
AWM-FC

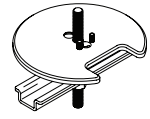

Grommet Clamp
AC-GC

2. Mount Clamp to Post

2.1 Slide clamp into post and position to desired height. Turn knob to lock in place.

If you are installing multiple mounts, use the guide marks on post as reference for setting the height of each arm. Final fine-tuning may be required once monitor is installed.

Note: Guide marks only available on 400 post, 510 post and 750 post.

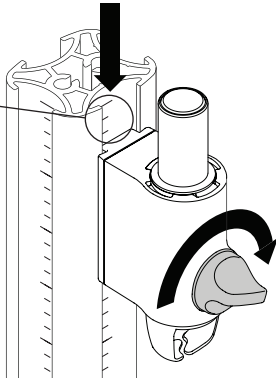

2.2 Do not mount monitor arm on rear channel post when using the following desk clamps:

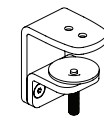

AWM-FF

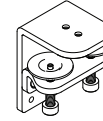

AWM-FH

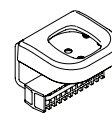

AWM-FC

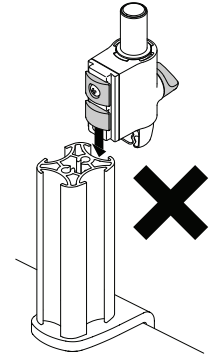

3. Position Cable Cover and fit Post Cap

3.1 To reposition the cable cover, pull it straight up and out of the post and insert it into any of the available channels

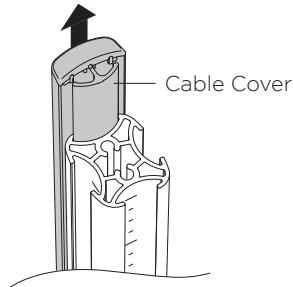

Cable Cover

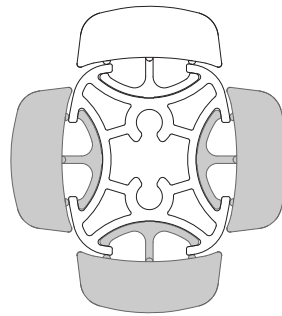

Optional cable cover positions

Note: Cable cover does not come with all posts

3.2 Fit post cap onto the top of the post

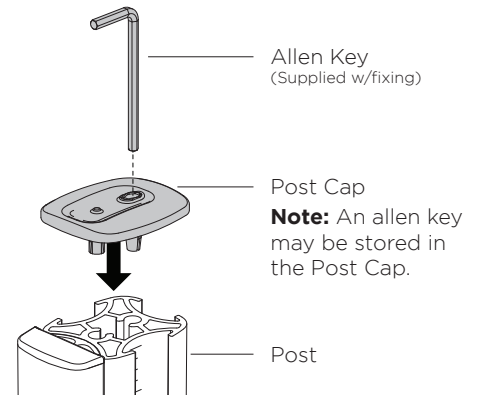

Allen Key
(Supplied w/fixing)

Post Cap

Note: An allen key may be stored in the Post Cap.

Post

4. Cable clips and cover

4.1 Push the cable down into the cable clip.

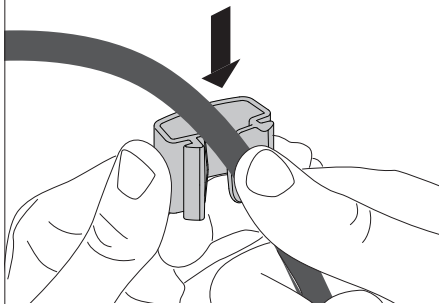

Note: Cable clips do not come with all posts. Additional clips sold separately.

4.2 Insert one side of the cable clip into the channel on the post assembly, then push in the other side.

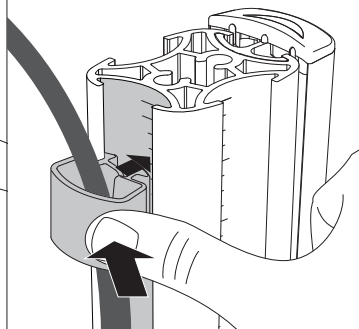

4.3 Loop cable and insert into cable cover.

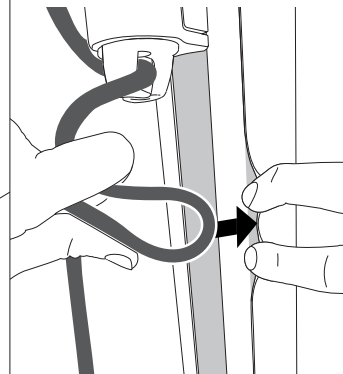

4.4 Feed remaining cable into the cover.

