

Atdec AWM Series

Index

Standard Product System Diagram		Page 2
Heads AWM-HV SNTB	VESA Head Notebook Holder	Dimensions Page 3 Page 3
Arms AWM-A13 AWM-A46 AWM-A71	Overview Dimensions Height Adjustment on Posts Height Adjustment on Wall Channels	Page 4 Page 5 Page 6 Page 7
Dynamic Arms AWM-AD AWM-LD	Overview Dimensions Dimensions on Post Height Adjustment on Posts Height Adjustment on Wall Channels	Page 8 Page 9 Page 10 Page 11 Page 12
Posts AWM-P13 AWM-P40 AWM-P75	Dimensions	Page 13
Wall Channels AWM-W6 AWM-W35	Dimensions	Page 14
Fixings AWM-FB AWM-FC AWM-FF AWM-FH AWM-WS	Bolt Through Kit C Clamp F Clamp Heavy Duty F Clamp Slat Wall Adaptor	Dimensions Dimensions Dimensions Dimensions Dimensions Page 15 Page 15 Page 16 Page 16 Page 17
Accessories APM01 AC-MP AC-GC	Power Module Mini PC Mount Plate Grommet Clamp	Page 18 Page 18 Page 18

STANDARD PRODUCT SYSTEM DIAGRAM

Important Note:

1. Any mounting surface must be capable of supporting the combined weight of all products, including attached screens and devices.
2. Ensure that your monitor solution is rated to support the combined weight of all products, including attached screens and devices.
3. All fixings are sold separately.

HEADS

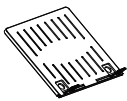

Notebook Tray
SNTB

ARMS

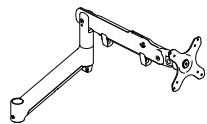

Dynamic Arm
AWM-AD



130 Arm
AWM-A13

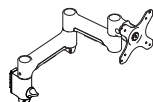

460 Arm
AWM-A46

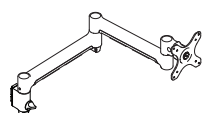

710 Arm
AWM-A71

INTERFACE LINKS

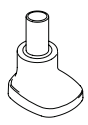

Arm Base
AWM-LB

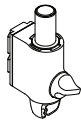

Arm Channel Clamp
AWM-LC

POSTS



135 Post
AWM-P13

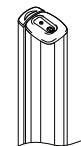

400 Post
AWM-P40

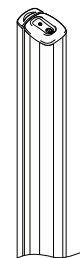

750 Post
AWM-P75

WALL CHANNELS



60 Wall Channel
AWM-W6



350 Wall Channel
AWM-W35

FIXINGS

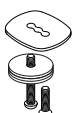

Bolt Through Kit
AWM-FB

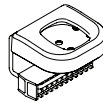

C Clamp
AWM-FC

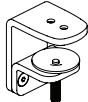

F Clamp
AWM-FF

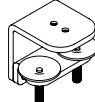

Heavy Duty F Clamp
AWM-FH

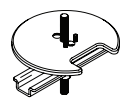

Grommet Clamp
AC-GC

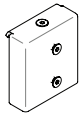

Slat Wall Adaptor
AWM-WS

ACCESSORIES



Power Module
APM01



Mini PC Mount Plate
AC-MP

HEADS

Important Note:

1. All arms are supplied with the VESA Head - AWM-HV (unless specified otherwise)
2. Other accessories are sold separately.

VESA Head AWM-HV

Dimensions

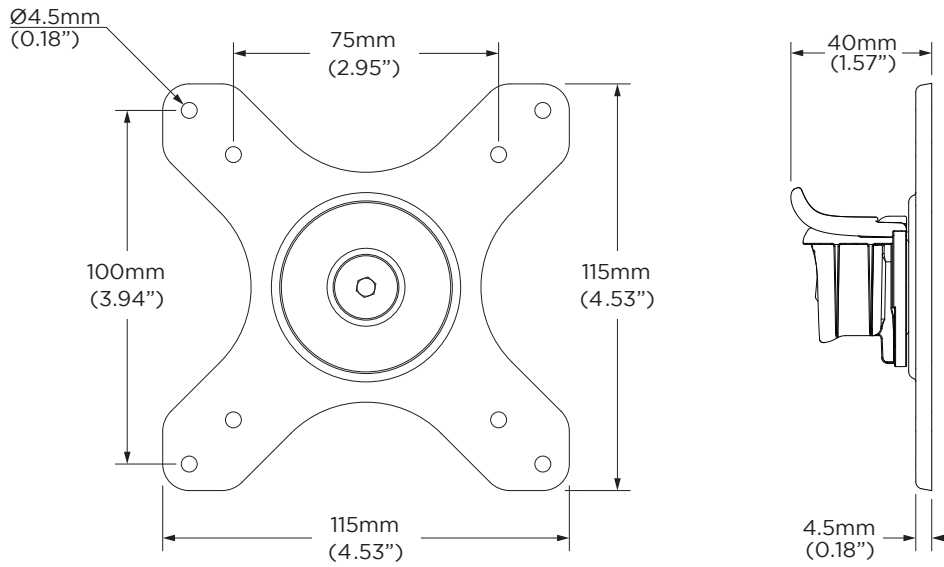

Notebook Tray SNTB

Important Note:

1. Maximum weight load 8kg (17.6 lbs).
2. Ensure solution is rated to support combined weight of all products and attached screens/devices.
3. 10 years limited warranty.
4. For further details refer to the Notebook Tray - SNTB Technical Specifications document.

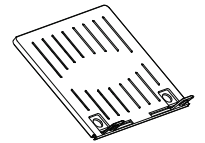

ARMS OVERVIEW

Important Note:

The rotation at the clamp can be reduced to 180° by using the rotation limiter ring. See product installation guide for instructions.

130 Arm AWM-A13

<p>Pan Movement MAX 360°/180°</p> <p>Monitor Rotation 360°</p>	<p>Tilt Angle</p>
<p>Weight</p> <p>MIN 0kg (0lbs) MAX 12kg (26.4lbs)</p>	

460 Arm AWM-A46

<p>Joint Movement MAX 360°/180°</p> <p>Joint Movement 360°</p> <p>Pan Movement 360°</p> <p>Monitor Rotation 360°</p>	<p>Tilt Angle</p>
<p>Weight</p> <p>MIN 0kg (0lbs) MAX 12kg (26.4lbs)</p>	

710 Arm AWM-A71

<p>Joint Movement MAX 360°/180°</p> <p>Joint Movement 360°</p> <p>Pan Movement 360°</p> <p>Monitor Rotation 360°</p>	<p>Tilt Angle</p>
<p>Weight</p> <p>MIN 0kg (0lbs) MAX 9kg (20lbs)</p>	

ARMS DIMENSIONS

130 Arm AWM-A13

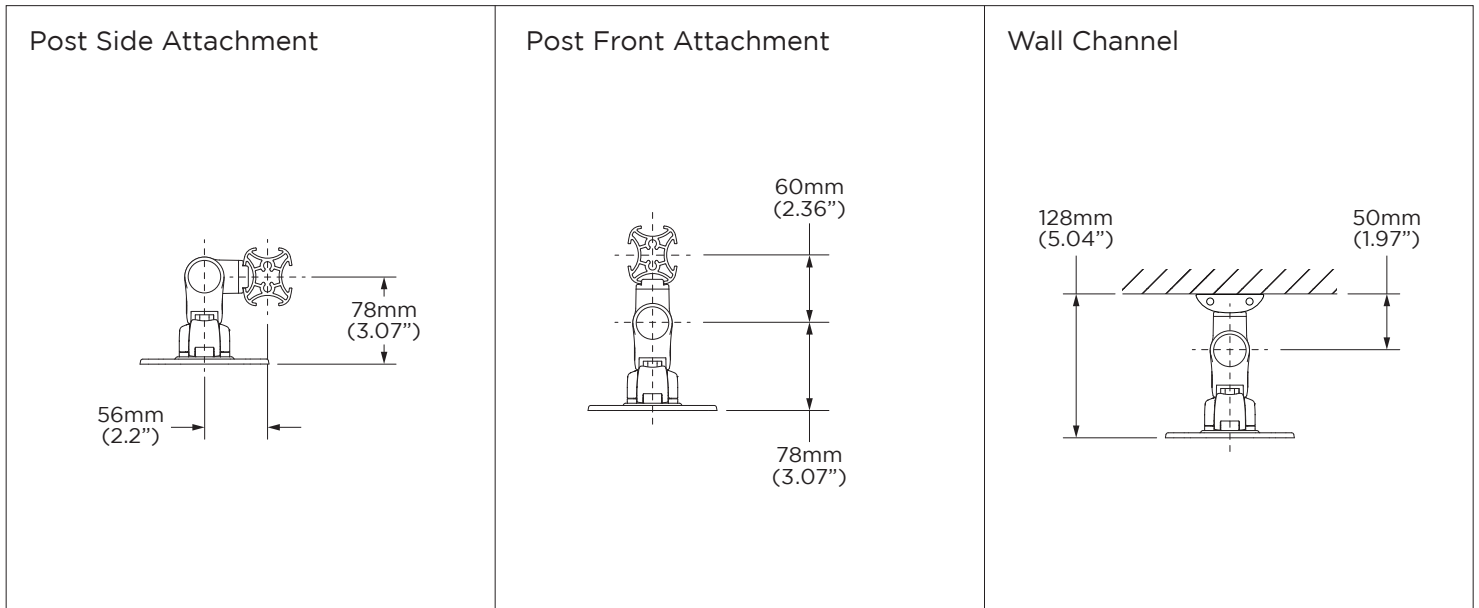

460 Arm AWM-A46

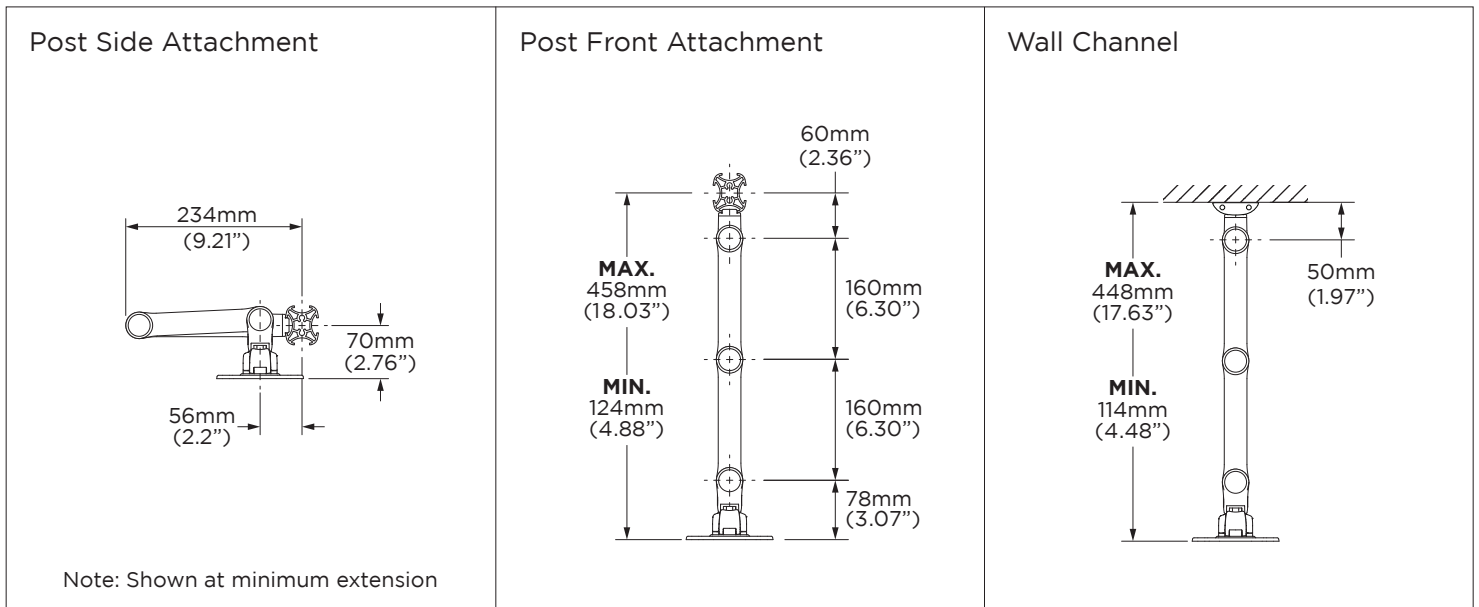

710 Arm AWM-A71

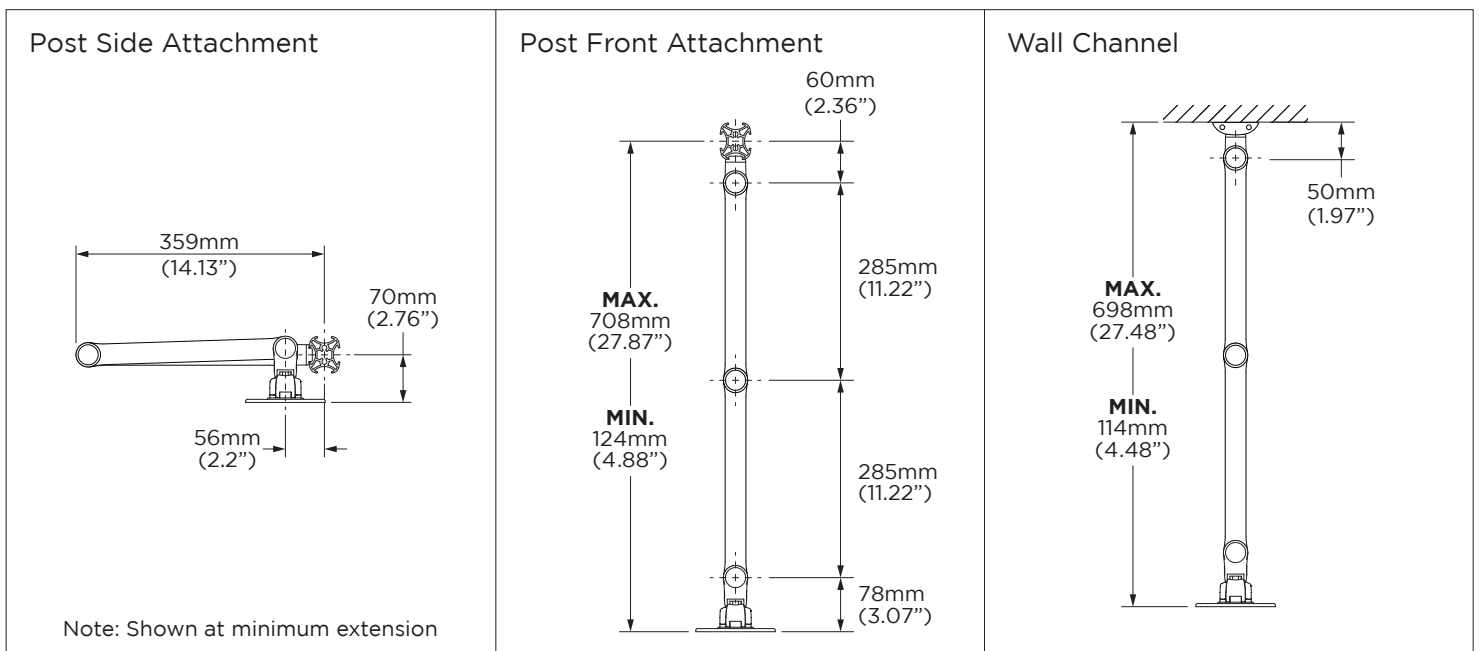



ARMS HEIGHT ADJUSTMENT ON POSTS

Important Note:

Measurements taken from centre of VESA mount.
The C Clamp (AWM-FC) increases the minimum height by 26mm.

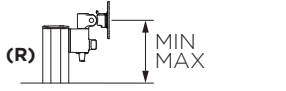
130 Arm AWM-A13 on Post

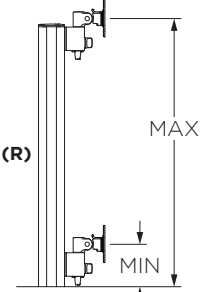
135 Post AWM-P13	400 Post AWM-P40	750 Post AWM-P75
 <p>MIN HEIGHT 110mm (4.33") MAX HEIGHT 163mm (6.42") RANGE (R) 53mm (2.09")</p>	 <p>MIN HEIGHT 110mm (4.33") MAX HEIGHT 428mm (16.85") RANGE (R) 318mm (12.52")</p>	 <p>MIN HEIGHT 110mm (4.33") MAX HEIGHT 778mm (30.63") RANGE (R) 668mm (26.3")</p>

460 Arm AWM-A46 on Post

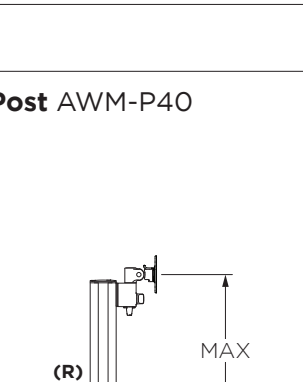
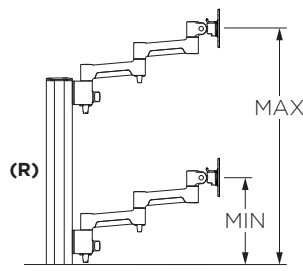
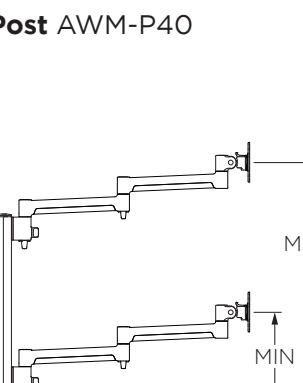
135 Post AWM-P13	400 Post AWM-P40	750 Post AWM-P75
 <p>MIN HEIGHT 233mm (9.17") MAX HEIGHT 286mm (11.26") RANGE (R) 53mm (2.09")</p>	 <p>MIN HEIGHT 233mm (9.17") MAX HEIGHT 551mm (21.69") RANGE (R) 318mm (12.52")</p>	 <p>MIN HEIGHT 233mm (9.17") MAX HEIGHT 901mm (35.47") RANGE (R) 668mm (26.3")</p>

710 Arm AWM-A71 on Post

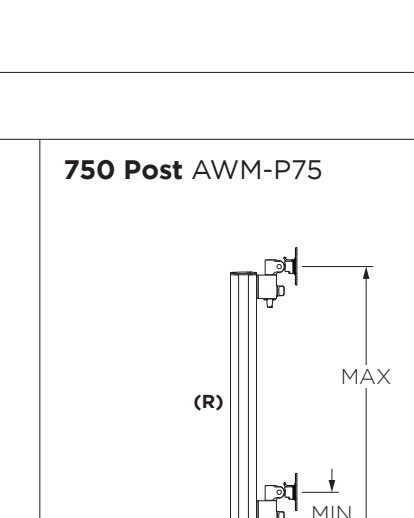
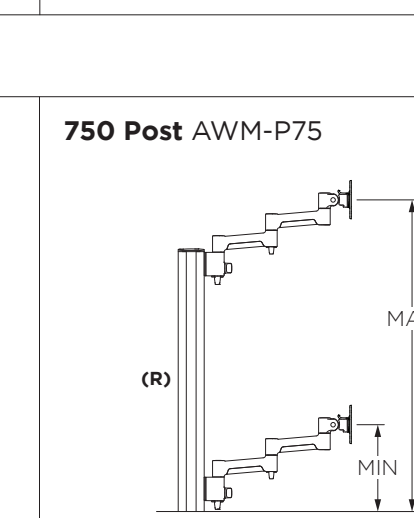
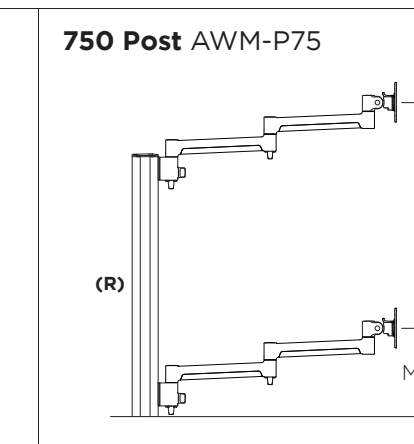
135 Post AWM-P13	400 Post AWM-P40	750 Post AWM-P75
 <p>MIN HEIGHT 230mm (9.06") MAX HEIGHT 283mm (11.14") RANGE (R) 53mm (2.09")</p>	 <p>MIN HEIGHT 230mm (9.06") MAX HEIGHT 548mm (21.57") RANGE (R) 318mm (12.52")</p>	 <p>MIN HEIGHT 230mm (9.06") MAX HEIGHT 898mm (35.35") RANGE (R) 668mm (26.3")</p>

ARMS HEIGHT ADJUSTMENT ON WALL CHANNELS

Important Note:

Measurements taken from bottom of wall channel to centre of VESA mount.

130 Arm AWM-A13 on Wall Channel

60 Wall Channel AWM-W6

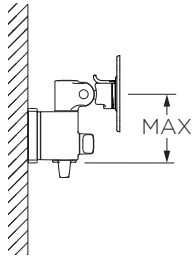

FIXED HEIGHT 92mm (3.62")

350 Wall Channel AWM-W35

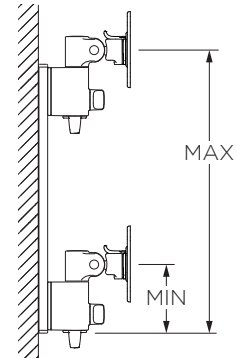

MIN HEIGHT 92mm (3.62")
MAX HEIGHT 382mm (15.04")
RANGE 290mm (11.42")

460 Arm AWM-A46 on Wall Channel

60 Wall Channel AWM-W6

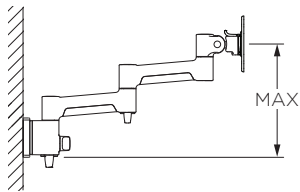

FIXED HEIGHT 224mm (8.82")

350 Wall Channel AWM-W35

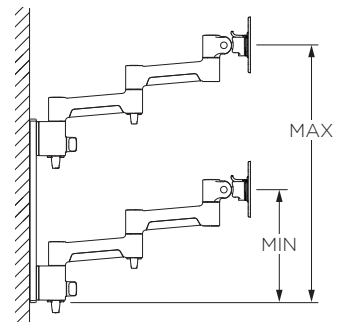

MIN HEIGHT 224mm (8.82")
MAX HEIGHT 514mm (20.24")
RANGE 290mm (11.42")

710 Arm AWM-A71 on Wall Channel

60 Wall Channel AWM-W6

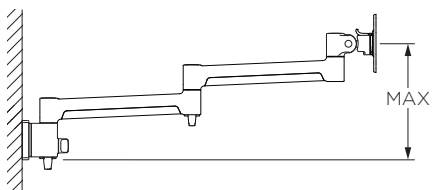

FIXED HEIGHT 221mm (8.7")

350 Wall Channel AWM-W35

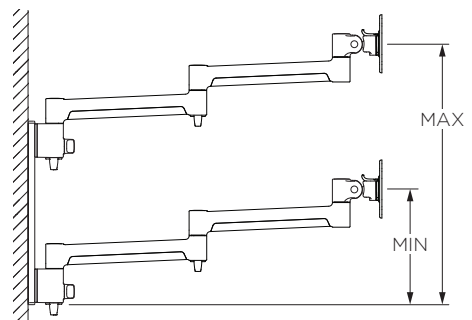

MIN HEIGHT 221mm (8.7")
MAX HEIGHT 511mm (20.12")
RANGE 290mm (11.42")

DYNAMIC ARMS OVERVIEW

Important Note:

The rotation at the clamp can be reduced to 180° by using the rotation limiter ring. See product installation guide for instructions.

Dynamic Arm AWM-AD with Channel Clamp AWM-LC

	<p>Tilt Angle</p>
	<p>Weight</p> <p>MIN 0kg (0lbs) MAX 9kg (20lbs)</p>

Dynamic Link AWM-LD with Channel Clamp AWM-LC

	<p>Tilt Angle</p>
	<p>Weight</p> <p>MIN 0kg (0lbs) MAX 9kg (20lbs)</p>

Dynamic Arm AWM-AD with Arm Base AWM-LB

	<p>Tilt Angle</p>
	<p>Weight</p> <p>MIN 0kg (0lbs) MAX 9kg (20lbs)</p>

DYNAMIC ARMS DIMENSIONS

Dynamic Arm AWM-AD with Channel Clamp AWM-LC



Dynamic Link AWM-LD with Channel Clamp AWM-LC

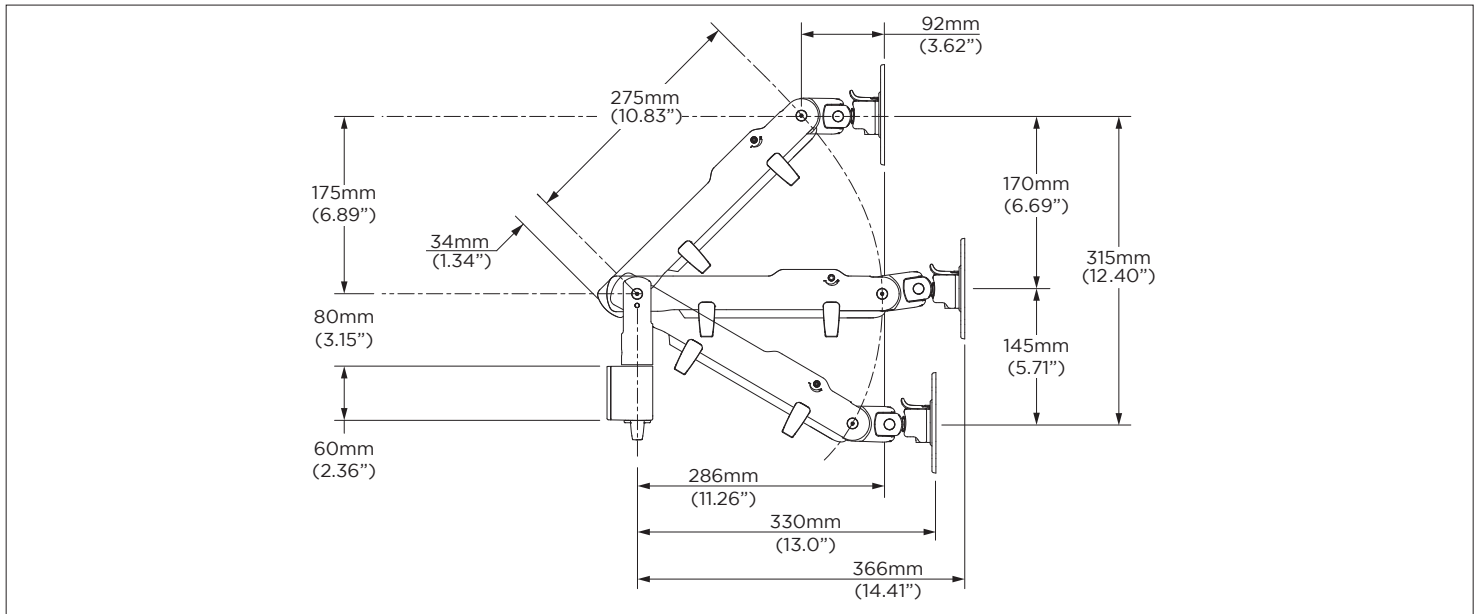

Dynamic Arm AWM-AD with Arm Base AWM-LB

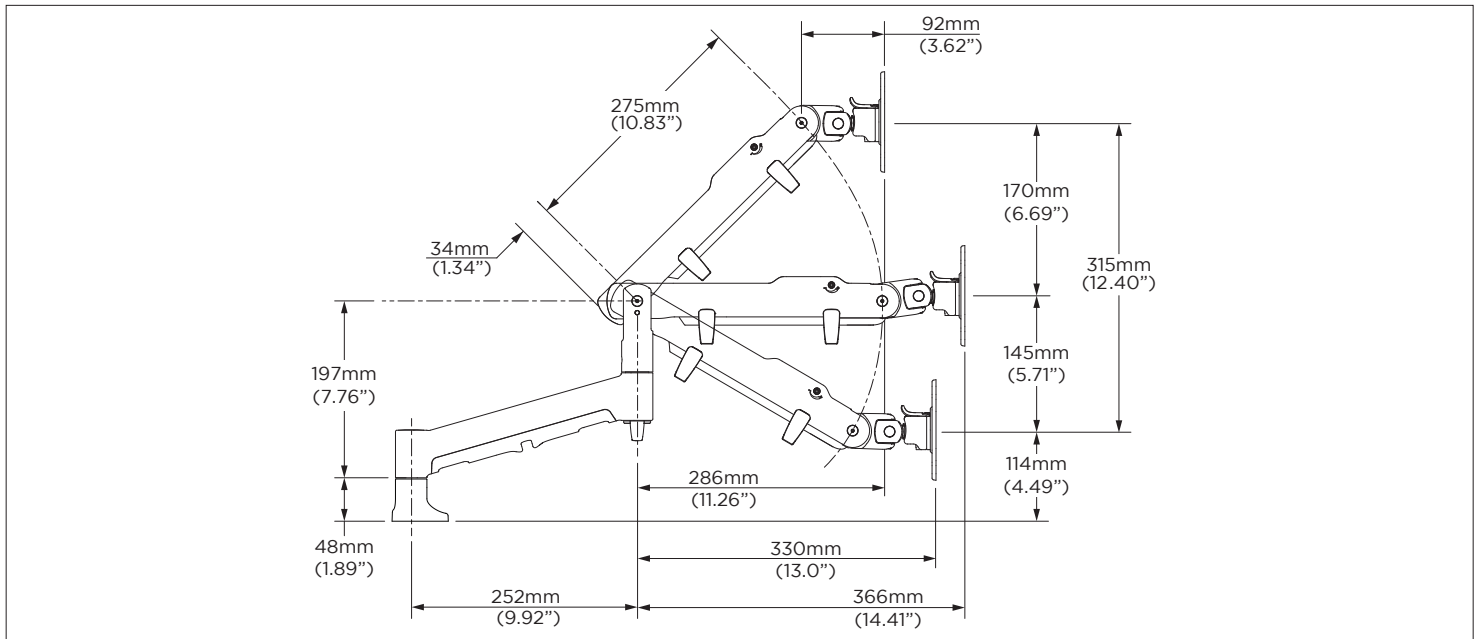

DYNAMIC ARMS DIMENSIONS ON POSTS & WALL CHANNELS

Dynamic Arm AWM-AD with Channel Clamp AWM-LC

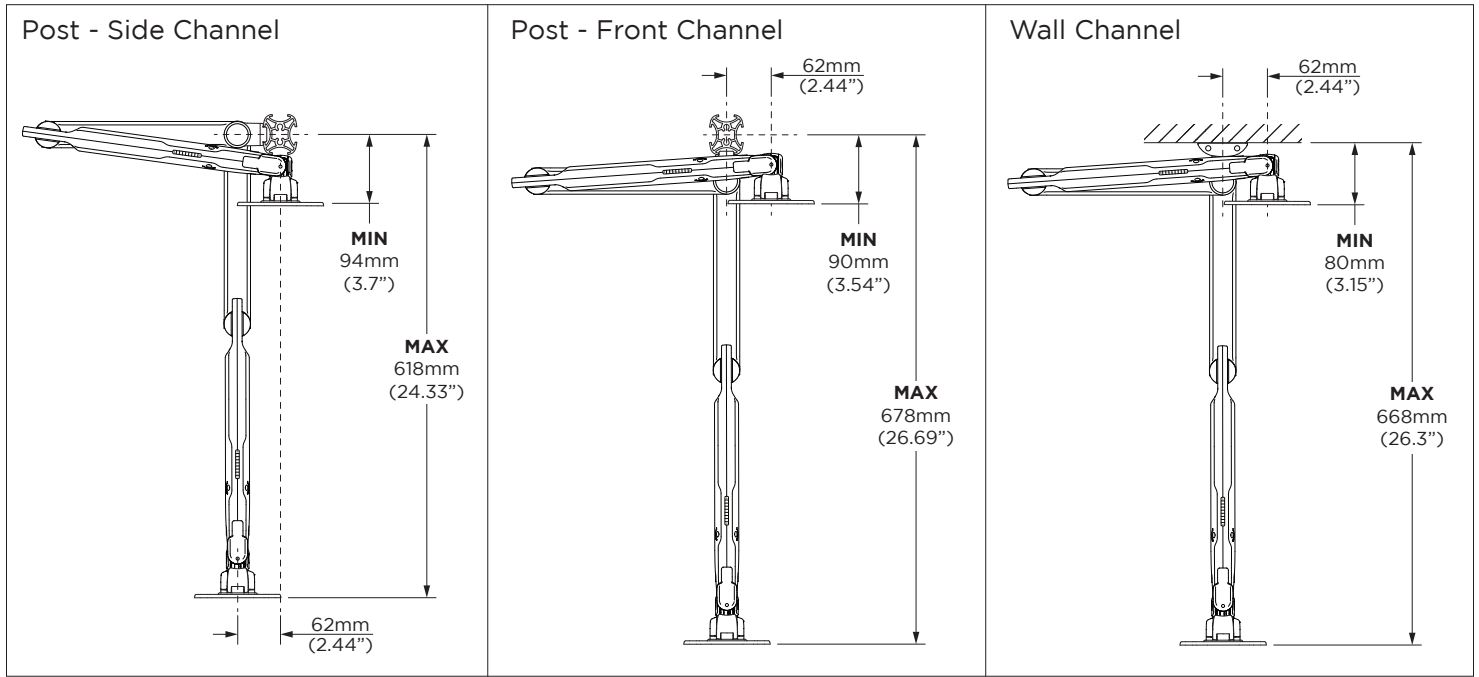

Dynamic Link AWM-LD with Channel Clamp AWM-LC

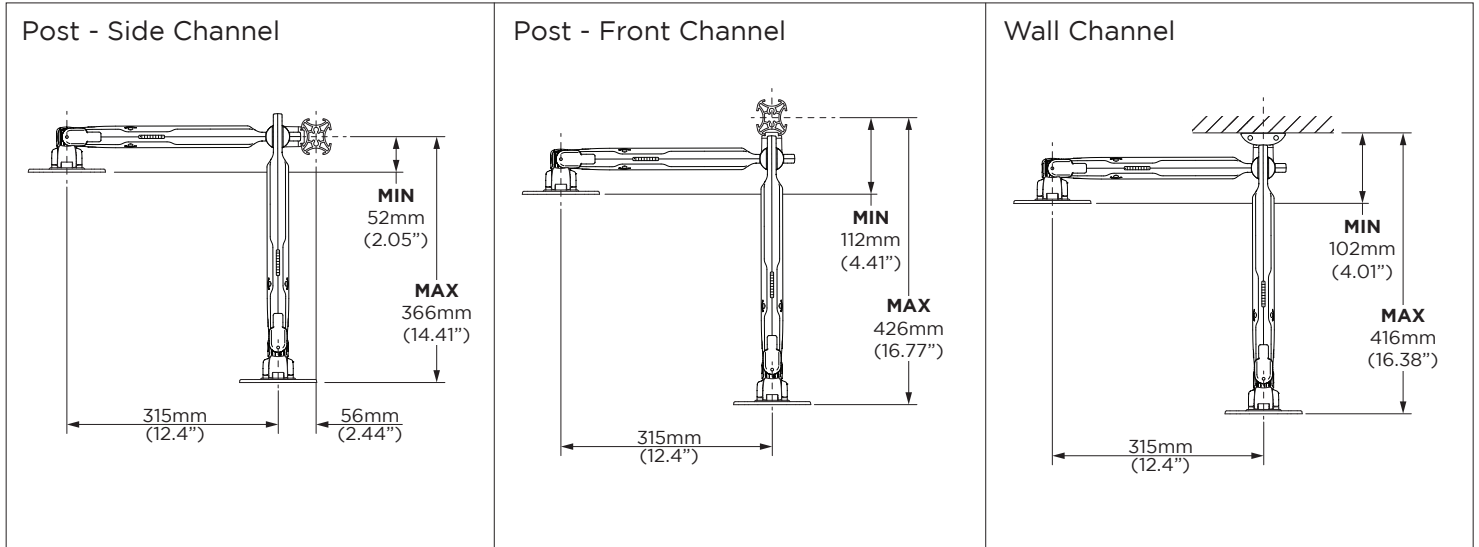

Dynamic Arm AWM-AD with Arm Base AWM-LB

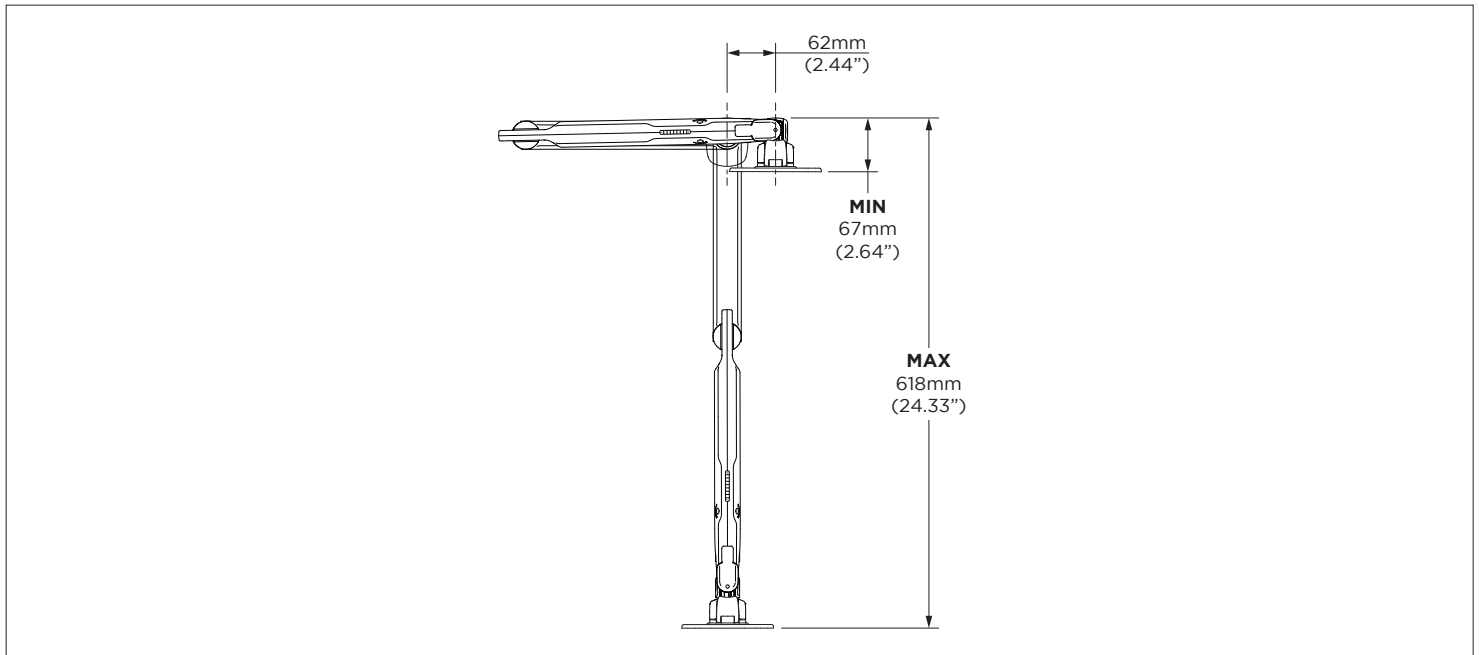

DYNAMIC ARMS HEIGHT ADJUSTMENT ON POST

Important Note:

Measurements taken from centre of VESA mount.
The C Clamp (AWM-FC) increases the minimum height by 26mm.

Dynamic Arm AWM-AD with Channel Clamp AWM-LC

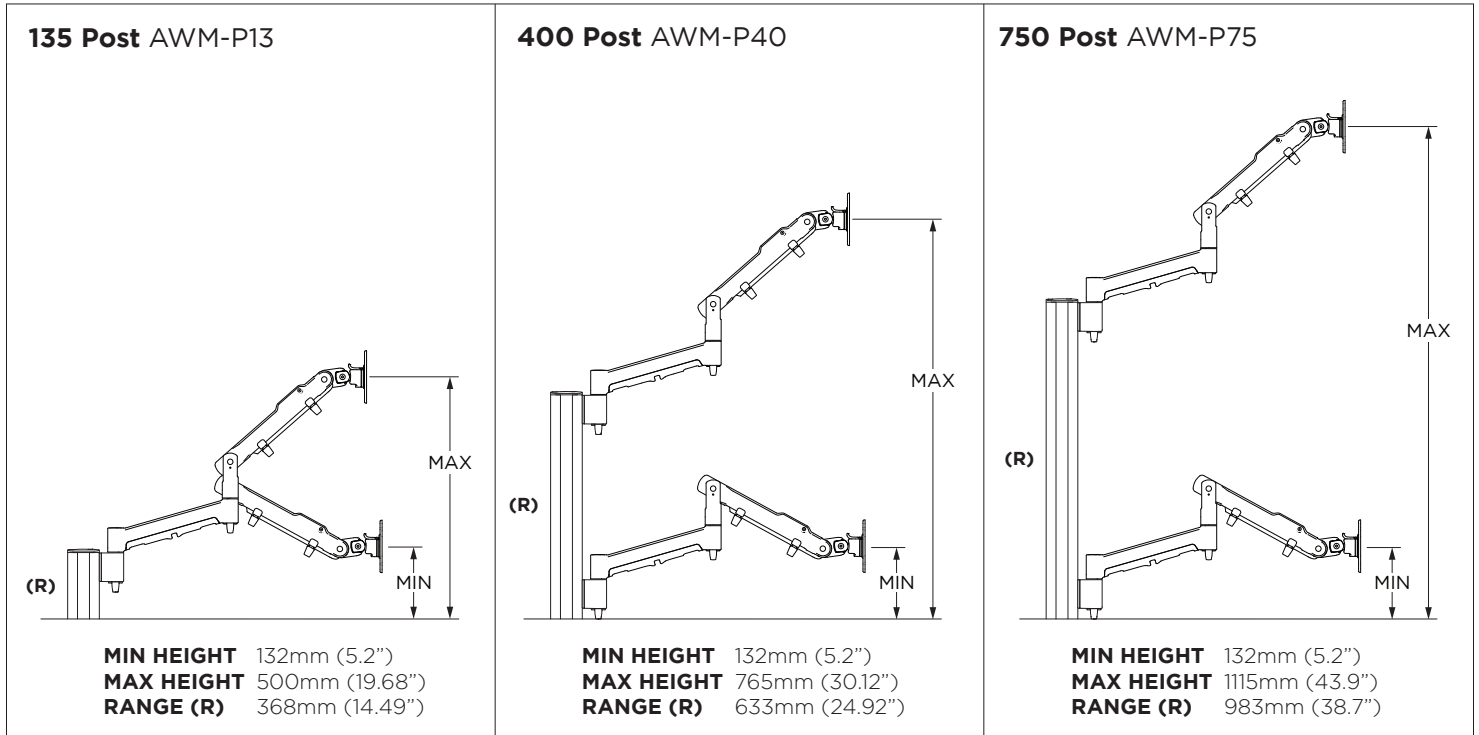

Dynamic Link AWM-LD with Channel Clamp AWM-LC

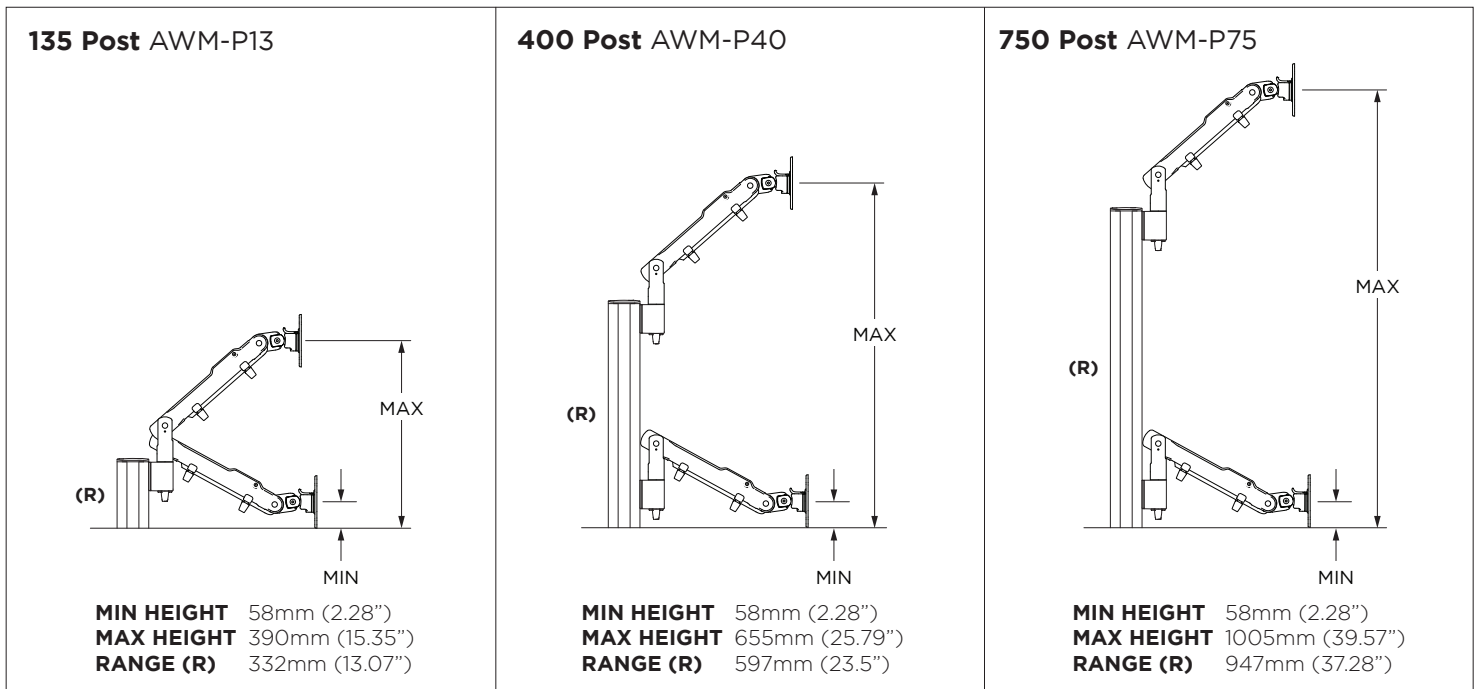

DYNAMIC ARMS HEIGHT ADJUSTMENT ON WALL CHANNEL

Important Note:

Measurements taken from bottom of wall channel to centre of VESA mount.

Dynamic Arm AWM-AD with Channel Clamp AWM-LC

60 Wall Channel AWM-W6

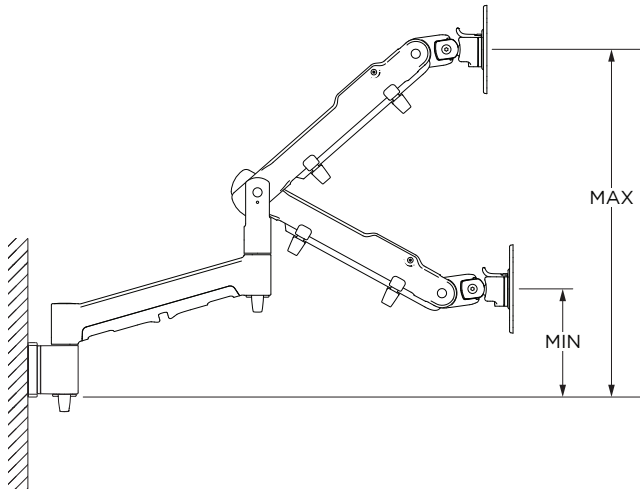

MIN HEIGHT 115mm (4.53")
MAX HEIGHT 430mm (16.93")
RANGE (R) 315mm (12.4")

350 Wall Channel AWM-W35

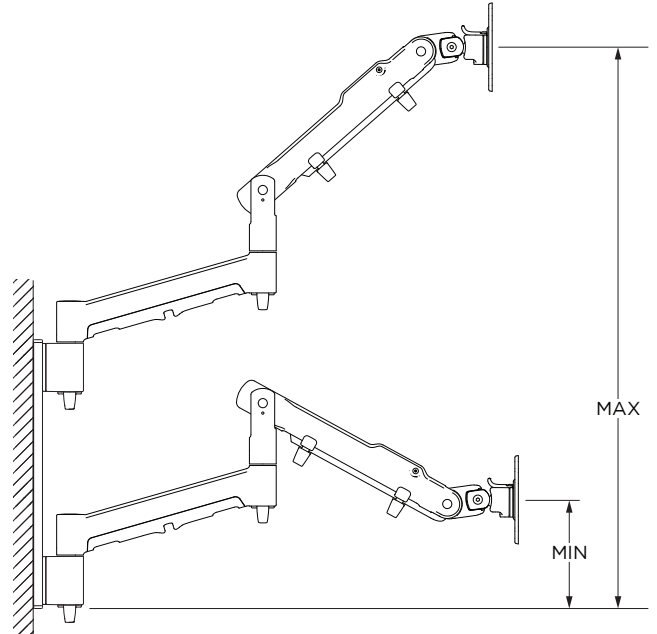

MIN HEIGHT 115mm (4.53")
MAX HEIGHT 728mm (28.35")
RANGE (R) 613mm (23.82")

Dynamic Link AWM-LD with Channel Clamp AWM-LC

60 Wall Channel AWM-W6

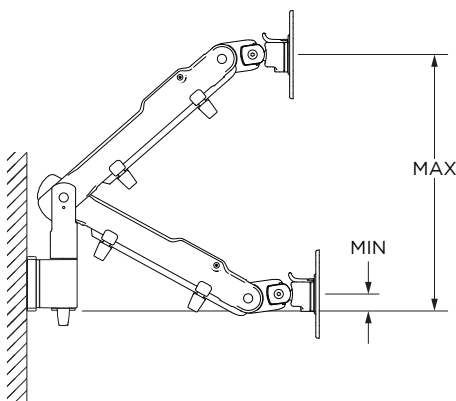

MIN HEIGHT 5mm (0.2")
MAX HEIGHT 320mm (12.6")
RANGE (R) 315mm (12.4")

350 Wall Channel AWM-W35

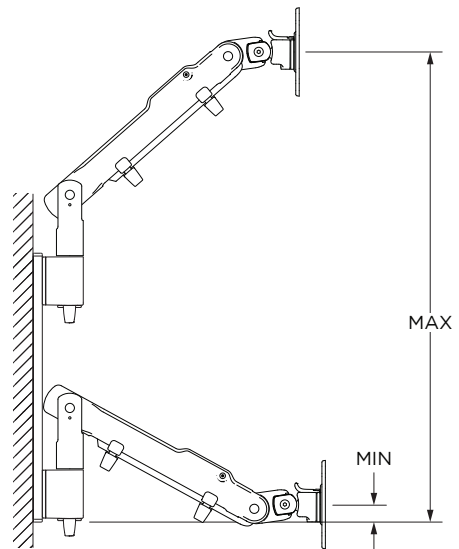

MIN HEIGHT 5mm (0.2")
MAX HEIGHT 618mm (24.01")
RANGE (R) 613mm (23.82")

POST DIMENSIONS

Top View

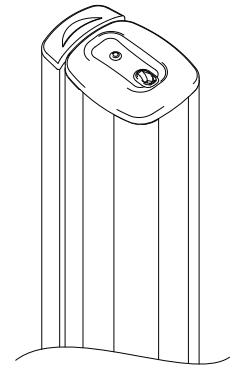
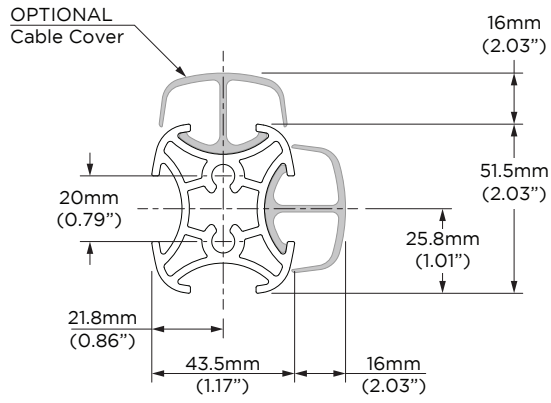

135 Post AWM-P13

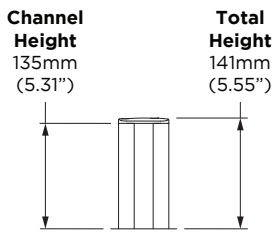

Compatible Fixings:

- Bolt Through Kit AWM-FB
- C Clamp AWM-FC
- F Clamp AWM-FF
- HD F Clamp AWM-FH
- Grommet Clamp AC-GC

400 Post AWM-P40

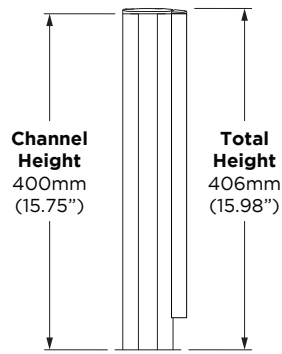

Compatible Fixings:

- Bolt Through Kit AWM-FB
- C Clamp AWM-FC
- F Clamp AWM-FF
- HD F Clamp AWM-FH
- Grommet Clamp AC-GC

750 Post AWM-P75

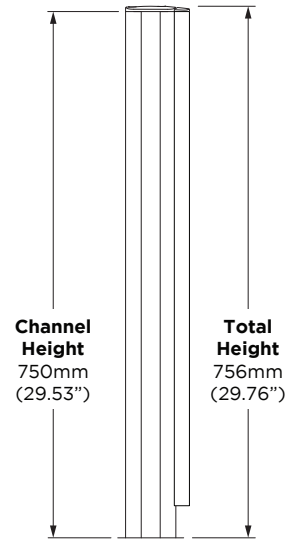

Compatible Fixings:

- Bolt Through Kit AWM-FB
- HD F Clamp AWM-FH
- Grommet Clamp AC-GC

WALL CHANNEL DIMENSIONS

Top View

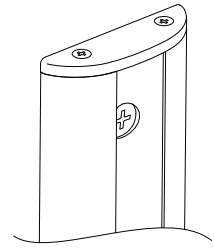
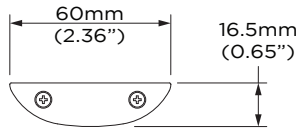

60 Wall Channel AWM-W6

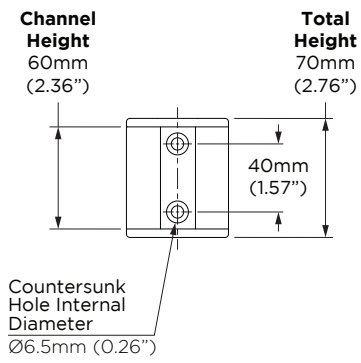

350 Wall Channel AWM-W35

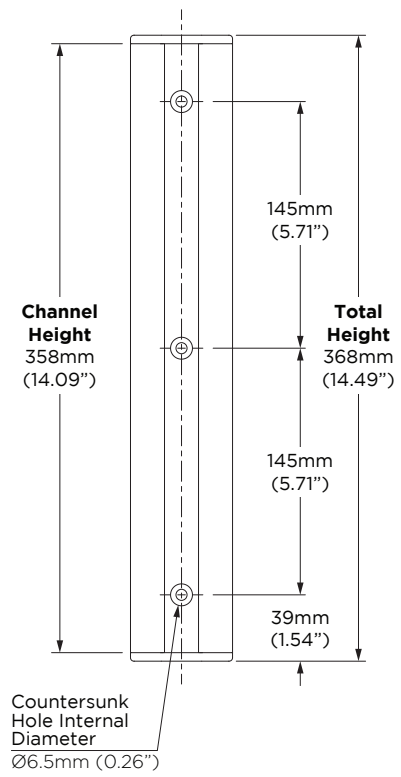

FIXINGS

Important Note:

1. Any mounting surface must be capable of supporting the combined weight of all products and attached screens/devices.
2. Ensure that your monitor solution is rated to support the combined weight of all products and attached screens/devices.
3. All fixings are sold separately.

Bolt Through Kit AWM-FB

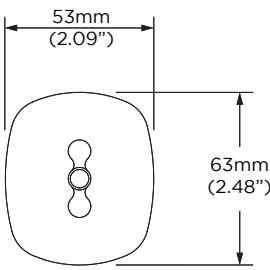
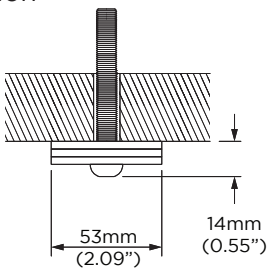
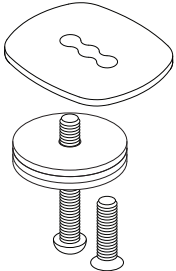
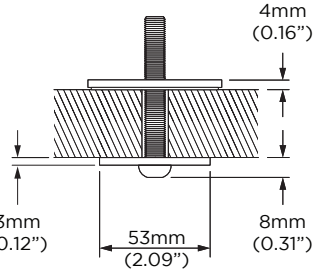
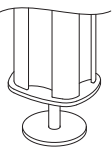
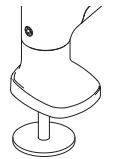
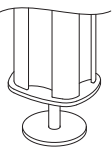
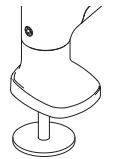
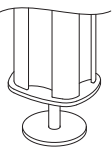
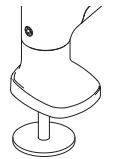
<p>Top View</p> 	<p>Arm Base (3 washer) Installation</p> 			
	<p>Post Installation</p> 	<p>Worksurface Thickness</p> <table border="0"> <tr> <td data-bbox="1061 817 1252 1108"> <p>POST</p>  <p>0 - 33mm (0 - 1.3")</p> </td> <td data-bbox="1300 817 1524 1108"> <p>ARM BASE</p>  <p>15 - 33mm (0.59 - 1.3")</p> </td> </tr> </table>	<p>POST</p>  <p>0 - 33mm (0 - 1.3")</p>	<p>ARM BASE</p>  <p>15 - 33mm (0.59 - 1.3")</p>
<p>POST</p>  <p>0 - 33mm (0 - 1.3")</p>	<p>ARM BASE</p>  <p>15 - 33mm (0.59 - 1.3")</p>			

C Clamp AWM-FC

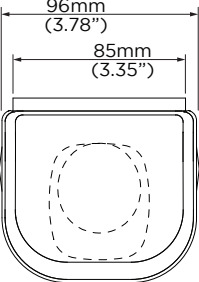
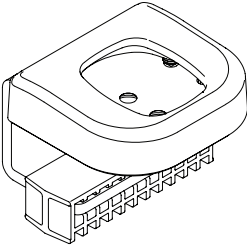
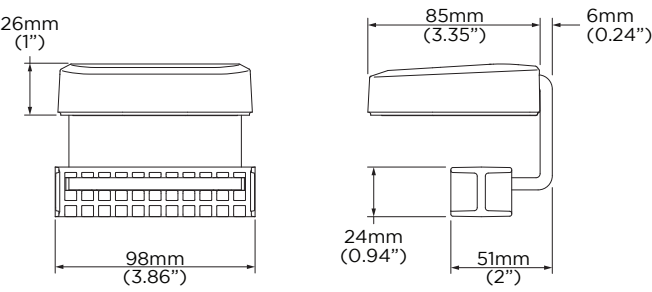
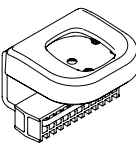
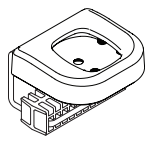
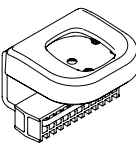
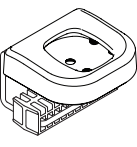
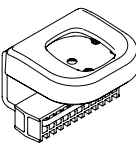
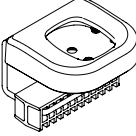
<p>Dimensions</p> 					
	<p>Worksurface Thickness</p> <table border="0"> <tr> <td data-bbox="1061 1713 1252 1982"> <p>DEFAULT</p>  <p>25 - 33mm (0.98 - 1.3")</p> </td> <td data-bbox="1300 1713 1524 1982"> <p>INVERTED</p>  <p>18 - 25.8mm (0.71"-1.0")</p> </td> </tr> <tr> <td colspan="2" data-bbox="1061 2027 1524 2078"> <p>RANGE 18-33mm (0.71 - 1.3")</p> </td> </tr> </table>	<p>DEFAULT</p>  <p>25 - 33mm (0.98 - 1.3")</p>	<p>INVERTED</p>  <p>18 - 25.8mm (0.71"-1.0")</p>	<p>RANGE 18-33mm (0.71 - 1.3")</p>	
<p>DEFAULT</p>  <p>25 - 33mm (0.98 - 1.3")</p>	<p>INVERTED</p>  <p>18 - 25.8mm (0.71"-1.0")</p>				
<p>RANGE 18-33mm (0.71 - 1.3")</p>					

F Clamp AWM-FF

Dimensions

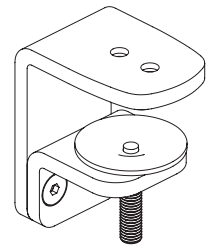
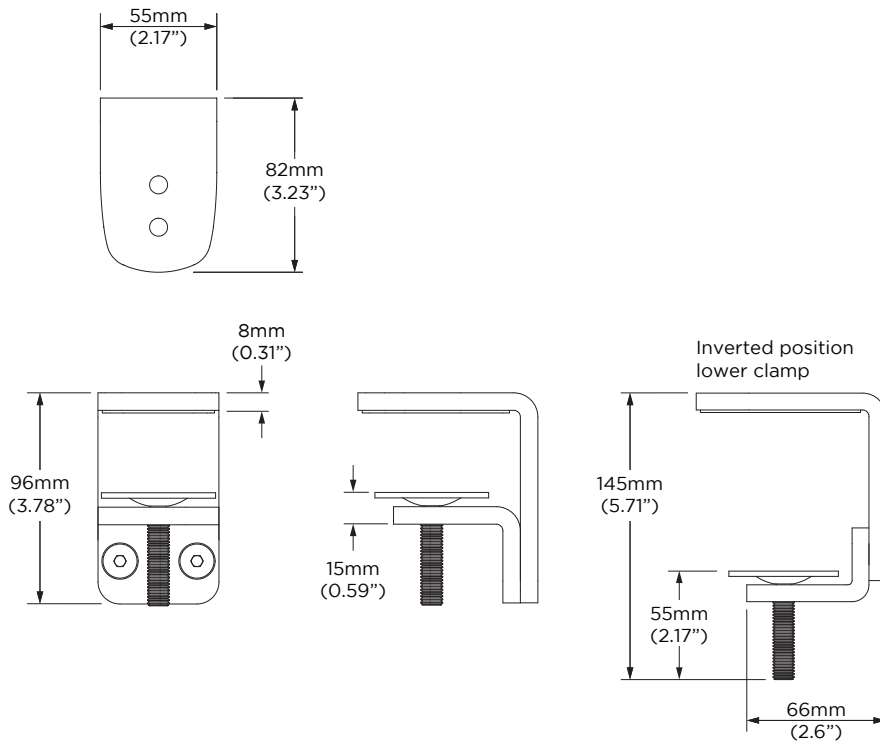

Worksurface Thickness

DEFAULT

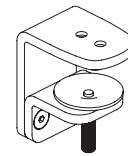

0 - 36mm
(0 - 1.42")

INVERTED

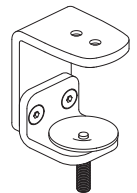

36 - 79mm
(1.42 - 3.11")

RANGE 0-79mm (0 - 3.11")

Heavy Duty F Clamp AWM-FH

Dimensions

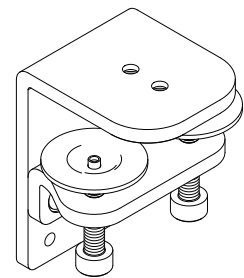
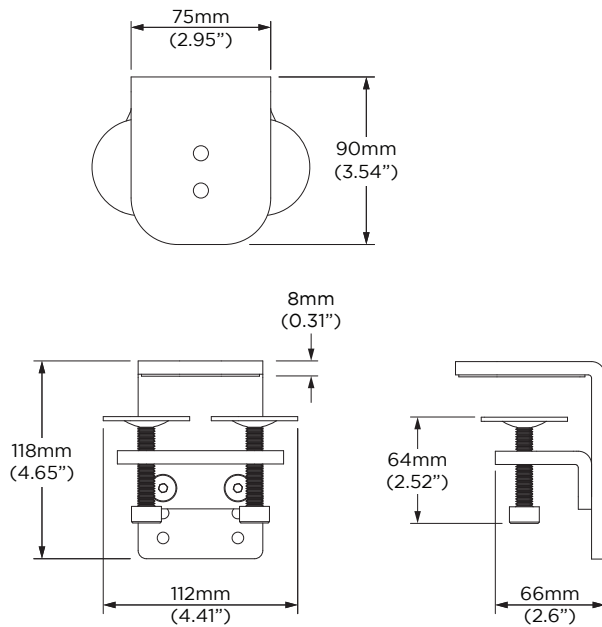

Worksurface Thickness

TOP

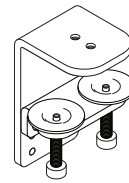

0 - 38mm
(0 - 1.5")

MIDDLE

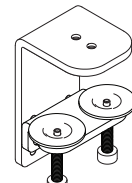

11-53mm
(0.43"-2.09")

BOTTOM

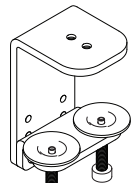

25-68mm
(0.98"-2.68")

RANGE 0-68mm (0-2.68")

Slat Wall Adaptor AWM-WS with 60 Wall Channel AWM-W6 (sold separately)

Dimensions

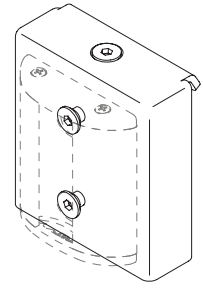
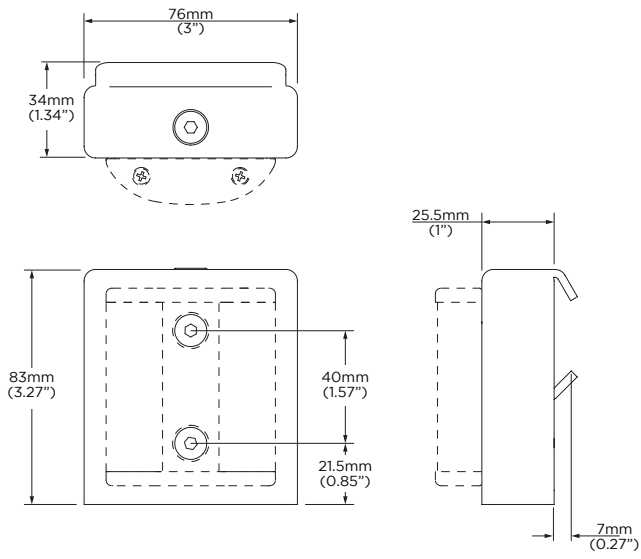

Slat Wall Groove Pitch

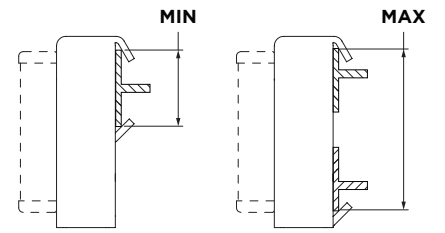

MIN PITCH 36mm (1.42")
MAX PITCH 78mm (3.07")

ACCESSORIES

Power Module APM01

Important Note:

1. The Power Module is compatible with all AWM fixings.
2. The Power Module is compatible with standard devices such as:
 - Apple iPhone, iPad
 - Android devices
 - Samsung tablets
 - Blackberry devices
 - Windows devices
 - Most other common USB-compatible charging devices not listed here
3. 12 months limited warranty
4. For further details refer to the Power Module - APM01 Technical Specifications document.

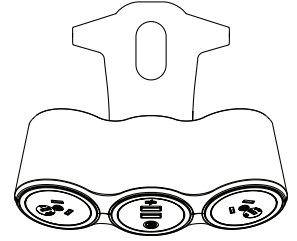

Mini PC Mount Plate AC-MP

Important Note:

1. Maximum weight load 5kg (11 lbs).
2. The Mini PC Mount Plate is compatible with all AWM Post and Wall Channel products.
3. The Mounting Plate can be placed at any height on the Post or Wall Channel as desired.
4. Compatible with Intel NUC® devices and VESA 75x75mm and 100x100mm hole pattern compliant devices.
5. Slots allow mounting of NUCs with both 84 and 95mm mounting hole spacings.
6. Ensure solution is rated to support combined weight of all products and attached screens/devices.
7. 10 years limited warranty (parts and workmanship).
8. For further details refer to the Mini PC Mount Plate - AC-MP Technical Specifications document.

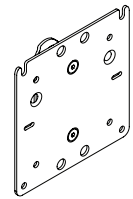

Grommet Clamp AC-GC

Important Note:

1. The Grommet Clamp fixing is compatible with AWM Series Post and Base products.
2. Ensure the overall solution is rated to support the combined weight of all products and attached screens/devices.
3. For further details refer to the Grommet Clamp Technical Specifications document.

