

## Post

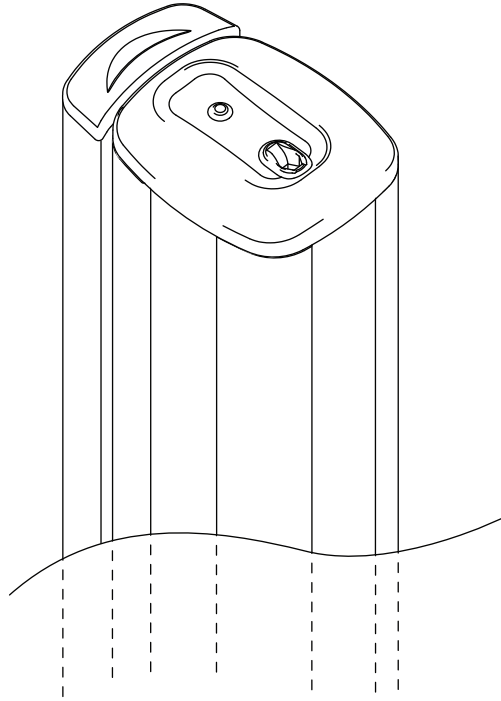

### COMPONENT CHECKLIST

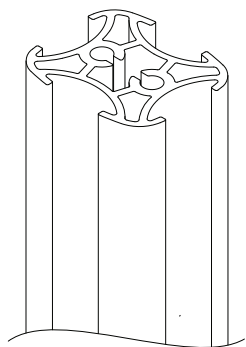

**A**  
Post  
(x1)

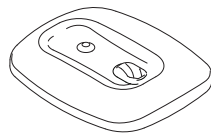

**B**  
Post Cap  
(x1)



**C**  
Screw  
M8  
(x2)



**D**  
Cable Cover Cap  
(x1)  
(not supplied  
with all posts)

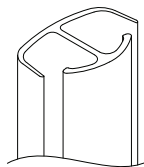

**E**  
Cable Cover  
(x1)  
(not supplied  
with all posts)



**F**  
Cable clips  
(not supplied  
with all posts)

Desk 

### REQUIRED TOOLS

- All tools provided

### IMPORTANT INFORMATION

- ! Please ensure this product is installed as per these installation instructions.
- ! This product is compatible with Atdec AWM Series products.
- ! The manufacturer accepts no responsibility for incorrect installation.

## 1. Attach Post to fixing (fixing sold separately)

**1.1** Follow the installation guide provided with your fixing to attach it to the post and fit it to the worksurface.

### AWM Fixing options

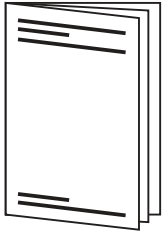

**Bolt Through Kit**  
AWM-FB

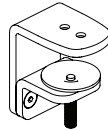

**F Clamp**  
AWM-FF

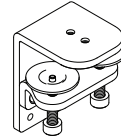

**Heavy Duty F Clamp**  
AWM-FH

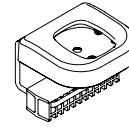

**C Clamp**  
AWM-FC

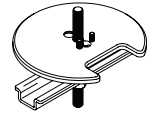

**Grommet Clamp**  
AC-GC

## 2. Check post placement & arm positions

**2.1** Do not mount a monitor arm on the rear channel of a post when the post is fixed to the desk using an F Clamp, Heavy Duty F Clamp, or C Clamp.

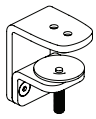

**F Clamp**  
AWM-FF

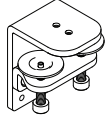

**Heavy Duty F Clamp**  
AWM-FH

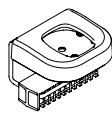

**C Clamp**  
AWM-FC

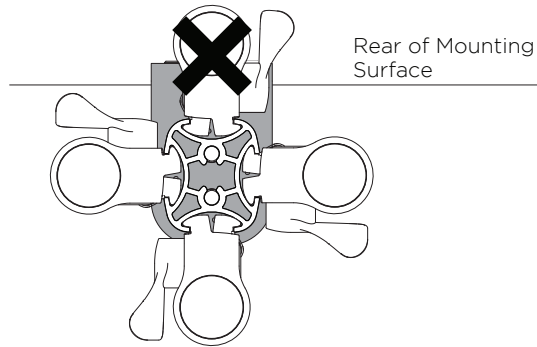

## 3. Cable cover position and post cap

**3.1** To reposition the cable cover, pull it straight up and out of the post and insert it into any of the available channels

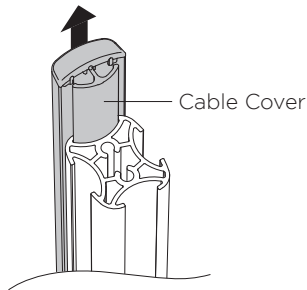

**Note:** The cable cover shown does not come with all posts

**3.2** Optional cable cover positions

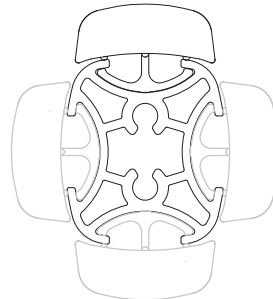

**3.3** Fit post cap onto the top of the post

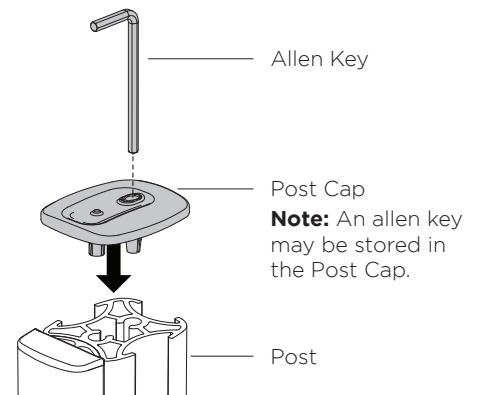

## 4. Cable clips and cover

**4.1** Push the cable down into the cable clip.

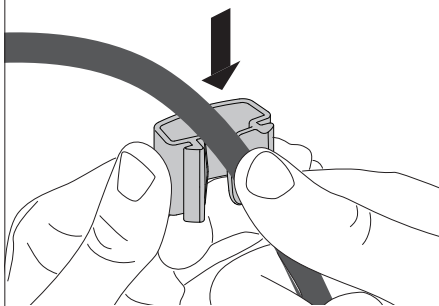

**Note:** Cable clips do not come with all posts. Additional clips sold separately.

**4.2** Insert one side of the cable clip into the channel on the post assembly, then push in the other side.

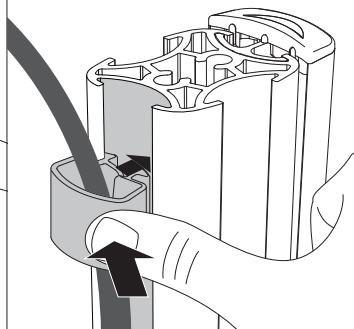

**4.3** Loop cable and insert into cable cover.

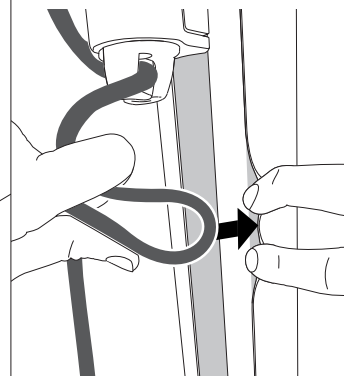

**4.4** Feed remaining cable into the cover.

