



**USB Dual View KVM Extender
CE774 / CE775
User Manual**



EMC Information

FEDERAL COMMUNICATIONS COMMISSION INTERFERENCE STATEMENT: This equipment has been tested and found to comply with the limits for a Class A digital device, pursuant to Part 15 of the FCC Rules. These limits are designed to provide reasonable protection against harmful interference when the equipment is operated in a commercial environment. This equipment generates, uses, and can radiate radio frequency energy and, if not installed and used in accordance with the instruction manual, may cause harmful interference to radio communications. Operation of this equipment in a residential area is likely to cause harmful interference in which case the user will be required to correct the interference at his own expense.

The device complies with Part 15 of the FCC Rules. Operation is subject to the following two conditions: (1) this device may not cause harmful interference, and (2) this device must accept any interference received, including interference that may cause undesired operation.

FCC Caution: Any changes or modifications not expressly approved by the party responsible for compliance could void the user's authority to operate this equipment.

CE Warning: This is a class A product. In a domestic environment this product may cause radio interference in which case the user may be required to take adequate measures.

Suggestion: Shielded twisted pair (STP) cables must be used with the unit to ensure compliance with FCC & CE standards.

KCC Statement

유선 제품용 / A 급 기기 (업무용 방송 통신 기기)
이 기기는 업무용 (A 급) 전자파적합기기로서 판매자 또는 사용자는 이 점을 주의하시기 바라며 , 가정 외의 지역에서 사용하는 것을 목적으로 합니다 .

RoHS

This product is RoHS compliant.



User Information

Online Registration

Be sure to register your product at our online support center:

International	http://support.aten.com
---------------	---

Telephone Support

For telephone support, call this number:

International	886-2-8692-6959
China	86-400-810-0-810
Japan	81-3-5615-5811
Korea	82-2-467-6789
North America	1-888-999-ATEN ext 4988
United Kingdom	44-8-4481-58923

User Notice

All information, documentation, and specifications contained in this manual are subject to change without prior notification by the manufacturer. The manufacturer makes no representations or warranties, either expressed or implied, with respect to the contents hereof and specifically disclaims any warranties as to merchantability or fitness for any particular purpose. Any of the manufacturer's software described in this manual is sold or licensed *as is*. Should the programs prove defective following their purchase, the buyer (and not the manufacturer, its distributor, or its dealer), assumes the entire cost of all necessary servicing, repair and any incidental or consequential damages resulting from any defect in the software.

The manufacturer of this system is not responsible for any radio and/or TV interference caused by unauthorized modifications to this device. It is the responsibility of the user to correct such interference.

The manufacturer is not responsible for any damage incurred in the operation of this system if the correct operational voltage setting was not selected prior to operation. PLEASE VERIFY THAT THE VOLTAGE SETTING IS CORRECT BEFORE USE.

Package Contents

The CE774 USB Dual View KVM Extender / CE775 USB Dual View KVM Extender with Deskew package consists of:

- ◆ 1 CE774L / CE775L (Local Unit)
- ◆ 1 CE774R / CE775R (Remote Unit)
- ◆ 1 USB KVM Cable Set
- ◆ 1 VGA Cable
- ◆ 2 Power Adapters
- ◆ 1 Mounting Kit
- ◆ 1 User Instructions*

Check to make sure that all the components are present and that nothing got damaged in shipping. If you encounter a problem, contact your dealer.

Read this manual thoroughly and follow the installation and operation procedures carefully to prevent any damage to the unit, and/or any of the devices connected to it.

* Features may have been added to the CE774 / CE775 since this manual was printed. Please visit our website to download the most up-to-date version

Copyright © 2017 ATEN® International Co., Ltd.
Manual Date: 2017-02-15
F/W Version: V1.0.078

ATEN and the ATEN logo are registered trademarks of ATEN International Co., Ltd. All rights reserved.
All other brand names and trademarks are the registered property of their respective owners.

Contents

EMC Information	ii
RoHS	ii
SJ/T 11364-2006	iii
User Information	iv
Online Registration	iv
Telephone Support	iv
User Notice	iv
Package Contents	v
Contents	vi
About this Manual	viii
Conventions	viii
Product Information	ix
1. Introduction	
Overview	1
Features	2
Requirements	4
Consoles	4
Computers	4
Cables	4
Operating Systems	5
Components	6
CE774L / CE775L (Local Unit) Front View	6
CE774R (Remote Unit) Front View	7
CE774L / CE775L Rear View	9
CE774R / CE775R Rear View	9
2. Hardware Setup	
Rack Mounting	11
Installation	13
Grounding	13
Setting Up	15
Installation Diagrams	16
3. Operation	
Operating Modes	17
Mode Selection	17
Deskew and Picture Compensation	18
Wake Up PC	19
Firmware Upgrade	19
LED Display	20
CE774L / CE775L (Local Unit)	20
Hotkey Setting Mode	21

Invoking HSM	21
Alternate HSM Invocation Keys	22
Keyboard Operating Platform	22
Hotkey Summary Table.	23

4. Keyboard Emulation

Mac Keyboard.	25
Sun Keyboard.	26

5. The Firmware Upgrade Utility

Before You Begin	27
Starting the Upgrade.	28
Upgrade Succeeded.	31
Upgrade Failed	31

Appendix

Safety Instructions	33
General	33
Rack Mounting	35
Technical Support.	36
International	36
North America	36
Specifications	37
Troubleshooting	39
Overview	39
About SPHD Connectors	39
Limited Warranty.	39

About this Manual

This User Manual is provided to help you get the most from your system. It covers all aspects of installation, configuration and operation. An overview of the information found in the manual is provided below.

Chapter 1, Introduction, introduces you to the CE774 / CE775 system. Its purpose, features and benefits are presented, and its front and back panel components are described.

Chapter 2, Hardware Setup, describes the steps that are necessary to quickly and safely set up your installation.

Chapter 3, Operation, explains the fundamental concepts involved in operating the CE774 / CE775.

Chapter 4, Keyboard Emulation, provides tables that list the PC to Mac and PC to Sun keyboard emulation mappings.

Chapter 5, The Firmware Upgrade Utility, explains how to use this utility to upgrade the CE774 / CE775's firmware with the latest available versions.

An Appendix, provides specifications and other technical information regarding the CE774 / CE775.

Conventions

This manual uses the following conventions:

Monospaced	Indicates text that you should key in.
[]	Indicates keys you should press. For example, [Enter] means to press the Enter key. If keys need to be chorded, they appear together in the same bracket with a plus sign between them: [Ctrl+Alt].
1.	Numbered lists represent procedures with sequential steps.
◆	Bullet lists provide information, but do not involve sequential steps.
→	Indicates selecting the option (on a menu or dialog box, for example), that comes next. For example, Start → Run means to open the <i>Start</i> menu, and then select <i>Run</i> .
	Indicates critical information.

Product Information

For information about all ATEN products and how they can help you connect without limits, visit ATEN on the Web or contact an ATEN Authorized Reseller. Visit ATEN on the Web for a list of locations and telephone numbers:

International	http://www.aten.com
---------------	---

Chapter 1

Introduction

Overview

The use of servers and server rooms is common and central across multiple industries today. The expanding volume of information and media prompts the addition of more servers in dedicated rooms located off the main site; thus the storage, retrieval and management of electronically stored data becomes a concern. The solution is a setup that makes it convenient to manage multiple servers, locally and remotely, while still making all data easily accessible.

The CE774 / CE775 is a USB based Dual View KVM Extender (with Deskew Function for CE775) that allows access to a computer system from a remote console. It is perfect for use in any type of installation where you need to place the console where it is conveniently accessible, but you want the system equipment to reside in a safe location – away from the dust and dirt of the factory floor, or the harsh environmental influence of a construction site, for example. This allows users to deploy system equipment over large distances.

The CE775 is equipped with a Deskew function that automatically synchronizes the time delay of RGB signals to compensate for distance.

The CE774 / CE775 features: 1) Gain/Compensation Control – adjusts signal strength in order to compensate for distance; 2) Dual Console operation – control your system from both the local and remote consoles; 3) RS-232 port, on both the Local and Remote Units to connect serial devices (see *Setting Up*, page 15); and 4) use of inexpensive Cat 5e/6 cable instead of bulkier, more expensive, standard cables, for a much neater, more convenient, more reliable data transfer connection.

Setup is as easy as can be – simply connect the computer system box and local console to the Local CE774L / CE775L Unit; run the Cat 5e/6 cable to the Remote CE774R / CE775R Unit (up to 300 meters away); and plug the remote console into the Remote Module. The CE774 / CE775 is useful for control and security purposes, with the hassle of a difficult installation, making it ideal for managing highly confidential data and media storage systems.

Features

- ◆ Local and Remote Units connect at distances of up to 300 m via Cat 5e/6 cable(s), allowing access to a computer or KVM installation from a remote console
- ◆ Dual console operation – control your system from both the local and remote USB keyboard, monitor, and mouse consoles
- ◆ Dual view support – connect to two screens in order to transmit two video output signals to the remote site
- ◆ Superior video quality – high quality images over long distance transmissions of up to 1920 x 1200 @ 60Hz (30 m); 1600 x 1200 @ 60Hz (150 m) for CE774; and 1920 x 1200 @ 60Hz (150 m); 1280 x 1024 @ 60Hz (300m) for CE775
- ◆ Deskew Function (CE775 only) – automatically synchronizes the time delay of RGB signals to compensate for distance
- ◆ Gain/Compensation Control – adjusts signal strength in order to compensate for distance
- ◆ Supports standard VGA resolutions from 640 x 480 to 1920 x 1200 @ 60Hz
- ◆ Supports popular wide screen formats, including 1440 x 900, 1400 x 1050, 1680 x 1050 and 1360 x 768
- ◆ Use of inexpensive Cat 5e/6 cables to connect the Local and Remote units – reduce the need for bulkier cables and provide a faster, more reliable data connection, while taking advantage of wiring systems already available in most office buildings
- ◆ Pushbutton operating mode selection – select between Local/Remote and Auto operating modes, with the press of a single button
- ◆ On Screen Display (CE775 only) – conveniently adjust video quality with the intuitive OSD menu system.
- ◆ PC Wakeup support – use a pushbutton on a Remote Unit to wake a PC at the local site via RS-232
- ◆ Built-in 8KV/15KV ESD protection (Contact voltage 8KV; Air voltage 15KV) and 2KV surge protection
- ◆ RS-232 serial ports – allow you to connect to a serial terminal or serial devices such as touchscreens and barcode scanners
- ◆ Audio enabled – supports stereo speakers and microphones
- ◆ Superior Audio – no loss in audio quality at 300 m

- ◆ Easy to install – no software required – connecting cables to the devices is all it takes
- ◆ Rack mountable
- ◆ Hot pluggable
- ◆ Sun/Mac keyboard support and emulation*
- ◆ Supports Wide Screen formats**

Notes:

- * 1. PC keyboard combinations emulate Sun/Mac keyboards.
2. Sun/Mac keyboards only work with their own computers.

** The EDID data for a widescreen is sent from the local video output port. For widescreen modes and displays connect the monitor to the local video output port or use an ATEN EDID emulator.

Requirements

Consoles

- ◆ Two (2) VGA monitors capable of the highest resolution that you will be using on any computer in the installation

Note: If you connect a DDC type monitor to the Local Unit, the monitor that connects to the Remote Unit must be able to support the highest video resolution that the DDC monitor can provide

- ◆ A USB keyboard

Note: You can use different brands and models of USB keyboard on the Local and Remote Units, but support for multi-function keyboards is limited to the standard 104 keys.

- ◆ A USB mouse

Note: You can use different brands and models of mouse on the Local and Remote Units, but only the left and right mouse buttons and scroll wheel features are supported. Other mouse features are not supported.

- ◆ Stereo microphone and stereo speakers (optional)

Computers

The following equipment must be installed on each computer that is to be connected to the system:

- ◆ Two (2) VGA ports
- ◆ USB host controller and Type A USB port

Cables

- ◆ For optimal signal integrity, and to simplify the layout, we strongly recommend that you use the high quality custom USB KVM Cable that is provided with this package.
- ◆ Cat 5e/6 cable is the minimum required to connect the Local and Remote CE774 / CE775 Units. Cable of a lower standard will result in degrading of the video signal. For best performance, we strongly recommend an ATEN 2L-2801 cable.
- ◆ VGA cable

Operating Systems

Supported operating systems are shown in the table, below:

OS		Version
Windows		2000, XP, Vista, 7
Linux	RedHat	7.1 and higher
	SuSE	9.0 and higher
	Mandriva (Mandrake)	9.0 and higher
UNIX	FreeBSD	4.2 and higher
	Sun	Solaris 8 and higher
Novell	Netware	6.0 and higher
Mac		OS 9 and higher

Components

CE774L / CE775L (Local Unit) Front View

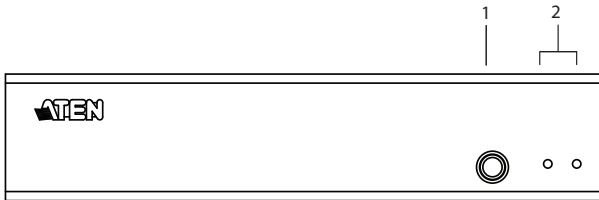

No.	Component	Description
1	Operating Mode Pushbutton	<p>This pushbutton toggles between the Operating Modes available from the Local Console:</p> <ul style="list-style-type: none"> ◆ Local – only the Local Console can control the system(s). ◆ Auto – both the Local and Remote Consoles can control the system. <p>Note: The default operating mode is <i>Auto</i>. See <i>Operating Modes</i>, page 17, for full details.</p> <p>It can also be used to upgrade the firmware version. See <i>Firmware Upgrade</i>, page 19 for more information.</p>
2	LEDs	<p>The CE774L / CE775L has two LEDs to indicate the operating status of the Local Unit (CE774L / CE775L). See <i>LED Display</i>, page 20, for full details.</p>

CE774R (Remote Unit) Front View

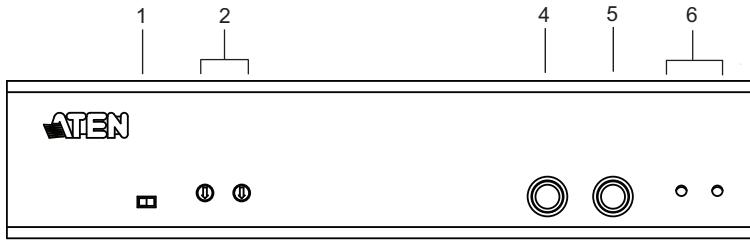

CE775R Front View

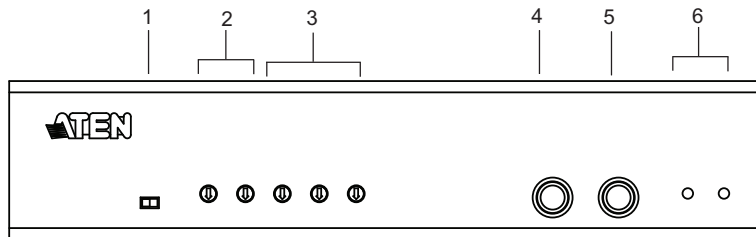

No.	Component	Description
1	Video Adjustment Port Selection	Use this switch to select which video output port you want to adjust.
2	Video Gain Tuner / Video Compensation Tuner	Use the Video Gain and Video Compensation tuners to adjust signal strength in order to compensate for distance. See <i>Deskew and Picture Compensation</i> , page 18 for details.
3	RGB Tuners (CE775R only)	For CE775R, adjust the RGB colors (R / G / B recessed tuners) to synchronize the time delay of RGB signals to compensate for distance. Turning these tuners displays the Deskew OSD (if enabled).
4	Wakeup PC Pushbutton	Press the <i>Wakeup PC</i> pushbutton to wake the computer at the local site through the RS-232 port. Press and hold this button for 3 seconds to automatically adjust the video display quality (for both output ports). See <i>Wake Up PC</i> , page 19 for more information.

No.	Component	Description
5	Operating Mode Pushbutton	<p>The <i>Auto / Remote</i> pushbutton toggles between the Operating Modes available from the Remote Console.</p> <ul style="list-style-type: none">◆ Auto – both the Local and Remote Consoles can control the system.◆ Remote – only the Remote Console can control the system(s). <p>Note: The default operating mode is <i>Auto</i>. See <i>Operating Modes</i>, page 17, for full details.</p> <p>It can also be used to upgrade the firmware version. See <i>Firmware Upgrade</i>, page 19 for more information.</p>
6	LEDs	<p>The CE774R / CE775R has two LEDs to indicate the operating status. See <i>LED Display</i>, page 20.</p>

CE774L / CE775L Rear View

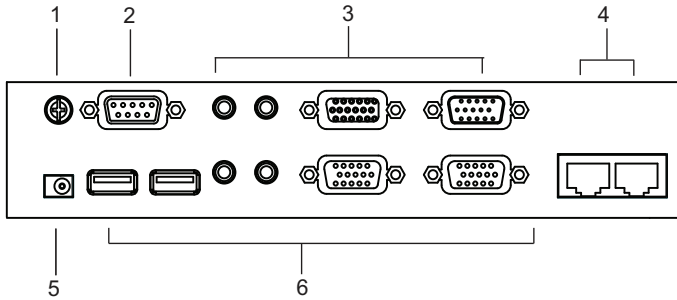

CE774R / CE775R Rear View

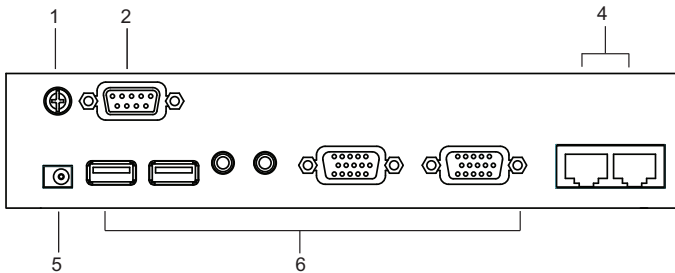

No.	Component	Description
1	Grounding Terminal	The grounding wire (used to ground the unit) attaches here. See <i>Grounding</i> , page 13, for further details.
2	RS-232 Serial Port	RS-232 serial devices – such as touchscreens or barcode scanners – plug into this port.
3	KVM Ports (Local Unit only)	Plug the connectors of the USB KVM cable supplied with this unit into the appropriate ports. Connect the VGA display device to the VGA port.
4	Remote I/O (Sub / Main)	The Cat 5e/6 cable that connects the Remote and Local Units plugs in here.
5	Power Jack	The cable from the DC Power adapter connects here.
6	Console Ports	The Local and Remote console's keyboard, monitor, and mouse plug into these ports. The mini stereo ports are for the speakers (green) and microphone (pink).

This Page Intentionally Left Blank

Chapter 2

Hardware Setup



1. Important safety information regarding the placement of this device is provided on page 33. Please review it before proceeding.
2. Make sure that the power to all devices connected to the installation are turned off. You must unplug the power cords of any computers that have the Keyboard Power On function.

Rack Mounting

For convenience and flexibility, the CE774L / CE775L and CE774R / CE775R can be mounted on system racks. To rack mount a unit do the following:

1. Using the screws provided in the Mounting Kit, screw the mounting bracket into the side panels of the unit as show in the diagram below:

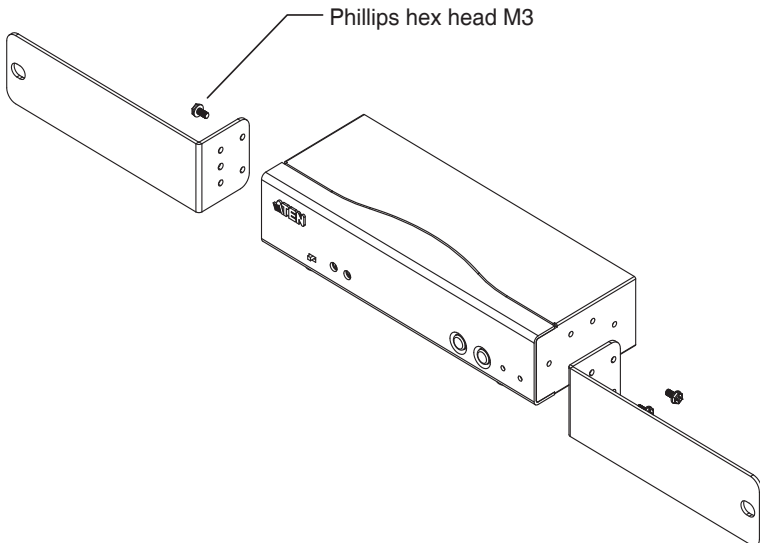

2. Screw the bracket into any convenient location on the rack.

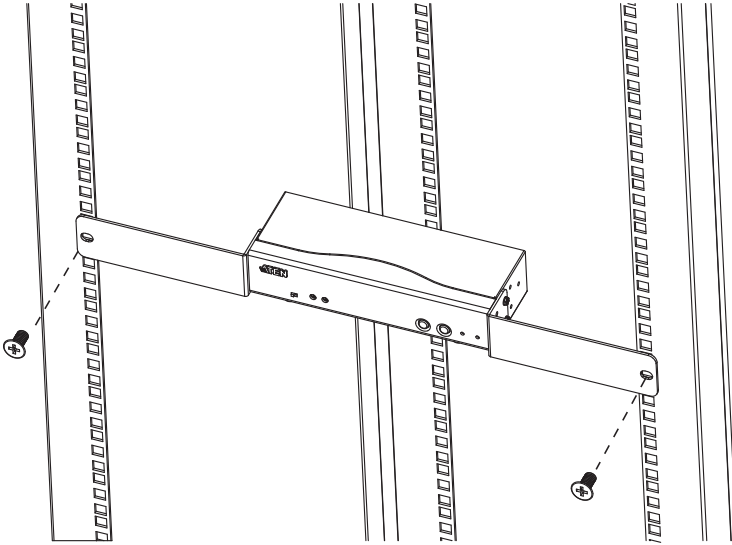

Note: We recommend that you use M5 x 12 Phillips Type I cross, recessed type screws.

Installation

Grounding

To prevent damage to your installation it is important that all devices are properly grounded.

1. Use a grounding wire to ground both units by connecting one end of the wire to the grounding terminal, and the other end of the wire to a suitable grounded object.

Note: The grounding wire is not included in the package. Please contact your dealer for the appropriate cable.

2. Make sure that the computer that the CE774L / CE775L connects to and the monitor that the CE774R / CE775R connects to are properly grounded.

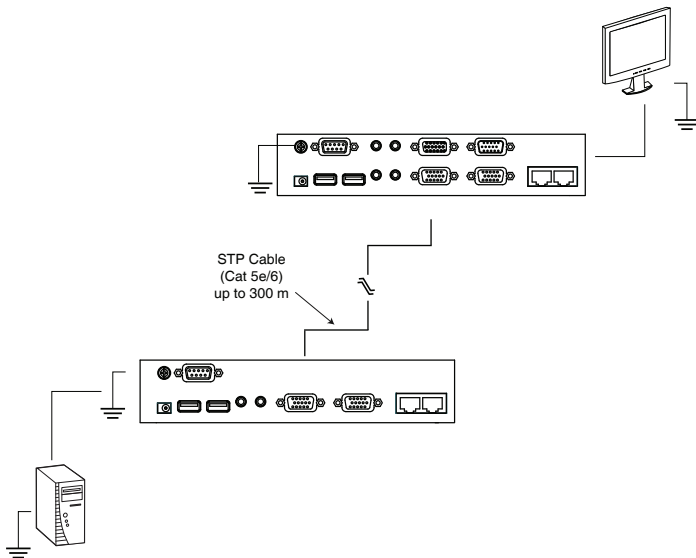

3. For increased grounding protection, use STP (shielded twisted pair) cable to connect the Local and Remote Units. There are two methods that can be used:
 - a) In addition to the eight paired wires, STP cable also contains a grounding wire. Solder this wire to the RJ-45 connector as shown in the diagram below:

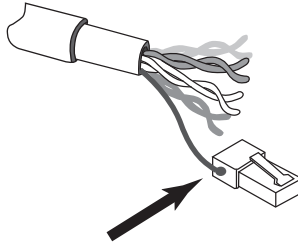

b) The second method is to use the STP cable shielding for grounding. In this case, make sure that the shielding makes tight contact with the top inside of the RJ-45 connector as shown in the diagram below:

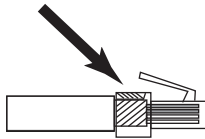

In either case, make sure that the sides of the RJ-45 connector make tight contact with the grounding contacts on the sides of the RJ-45 socket as shown in the diagram below:

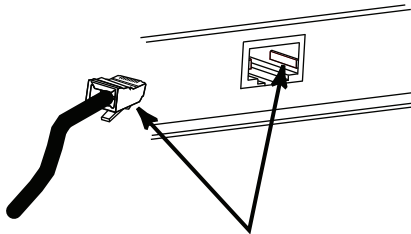

Setting Up

Setting up the CE774 / CE775 USB Dual View KVM Extender system is simply a matter of plugging in the cables. Make sure that all the equipment to be connected up is powered Off. Refer to the installation diagram on the following page and do the following:

1. Plug the cables from the local console devices (mouse, keyboard, monitor(s), microphone, speakers) into their ports on the Console section on the rear of the Local Unit (CE774L / CE775L). Each port is marked with an appropriate icon to indicate itself.
2. Plug the appropriate connectors on the USB KVM cable and VGA cable supplied with this unit into their ports on the CPU section on the rear of the Local Unit (CE774L / CE775L).
3. Plug the connectors on the other end of the USB KVM cable and VGA cable into the appropriate ports on the local computer. Each connector is marked with an appropriate icon to indicate which it is.

Note: If you are combining the CE774 / CE775 with a KVM switch, the other end of the USB KVM cable plugs into the appropriate ports on the KVM switch.

4. For control of serial devices, connect the RS-232 serial port on the local unit to a serial port on the local computer. Connect a serial device such as a touchscreen or barcode scanner to the RS-232 serial port on the remote unit.
5. Plug either end of the Cat 5e/6 cable(s) into the CE774L / CE775L's Remote I/O port(s). Plug the other end of the Cat 5e/6 cable(s) into the I/O port(s) of the Remote Unit (CE774R / CE775R).

Note: Connecting the SUB Cat 5e/6 cable enables you to manage the second VGA display (connected to the output port labeled "2"). Connecting the MAIN Cat 5e/6 cable is enough to make the setup work.

6. Plug one of the power adapters (supplied with this package) into an AC source; plug the adapter's power cable into the CE774L / CE775L's Power Jack.
7. Plug the cables from the remote console devices (mouse, keyboard, monitor(s), speakers, microphone), into their ports on the Console side of the CE774R / CE775R.

8. Plug the second power adapter (supplied with this package) into an AC source; plug the adapter's power cable into the CE774R / CE775R's Power Jack.

Note: Hot-plugging the Cat 5e/6 cable will automatically trigger the Gain/Compensation control and the Deskew function for CE774 / CE775.

Installation Diagrams

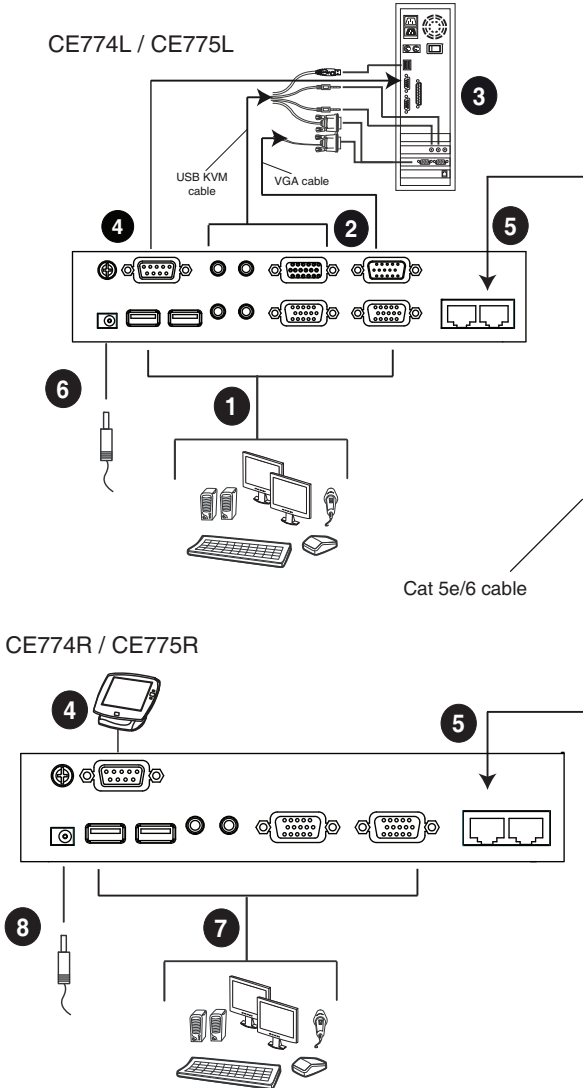

Chapter 3

Operation

Operating Modes

The CE774 / CE775 USB KVM Extender has three operating modes: Local, Auto, and Remote, as described in the table below:

Mode	Description
Local	Only the local console has KVM access. The remote console's keyboard and mouse input is disabled.
Auto	Both the local and remote consoles can have KVM access, but not at the same time. The console without access has to wait until the console with access stops inputting data before it can gain access.
Remote	The remote console has KVM access. Remote mode can only occur when the CE774L / CE775L is set to <i>Auto</i> and the local console is idle. The default operating mode is <i>Auto</i> .

Mode Selection

The *Operating Mode Selection Switch*, located on each unit's front panel, controls the operating mode of the USB Dual View KVM Extender with Deskew system. Pressing the switch toggles the operating mode as follows:

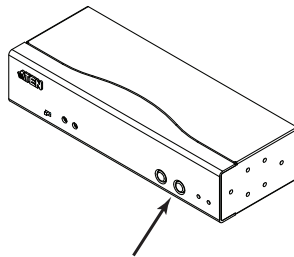

Switch	Action
Local (CE774L / CE775L) Selection Switch	Toggles between Auto and Local. In Local Mode, only the local console has keyboard and mouse access and control of the computer (or computers via KVM switch).
Remote (CE774R / CE775R) Selection Switch	Toggles between Auto and Remote. In Remote Mode, only the remote console has keyboard and mouse access and control of the computer (or computers via KVM switch).

When the system is in Local Mode, the Remote unit's selection switch is inactive. Pressing it has no effect – the Remote operator cannot take over control. The Remote selection switch only becomes active after the Local selection switch is pressed to put the system back into Auto Mode.

Likewise, if the system is in Remote Mode, the Local unit's selection switch is inactive – the Local operator cannot take over control. The Local selection switch only becomes active after the Remote selection switch is pressed to put the system back into Auto Mode.

The *Operating Mode* pushbutton can also be used to upgrade the firmware. See *Firmware Upgrade*, page 19 for more information.

Deskew and Picture Compensation

The quality of the video display can deteriorate with distance. The recessed tuners on the front panel of the CE774R / CE775R adjust the quality of the video on the remote console, as well as fix flickering/blinking screens.

- ◆ If it becomes necessary to fine-tune the video signal, use the *Gain* and *Compensation* tuners to adjust.
- ◆ For CE775R, in addition to the *Gain* and *Compensation* tuners, use the color (*R / G / B*) tuners to adjust the color settings of the video and correct any skew effects.

The recessed tuners can be turned using any small sized flat screw driver.

When turned, the Deskew OSD displays on screen giving a visual indicator for adjusting the video quality if this feature is enabled. You can also open the Deskew OSD by pressing [O] or [o] after invoking Hotkey Setting Mode (HSM). See *Hotkey Summary Table*, page 23 for more information.

Wake Up PC

When at the remote console's location and you want to wake a computer on the local site, use the *Wakeup PC* pushbutton on the front panel of the CE774R / CE775R. Make sure to use an RS-232 cable to connect the local computer to the CE774L / CE775L in order for this command to work.

- Note:**
1. Additionally, you can press and hold the *Wakeup PC* pushbutton for 3 seconds to automatically adjust the quality of the video displays (both outputs).
 2. The PC's BIOS should support RS-232 wake up function.
-

Firmware Upgrade

Refer to *The Firmware Upgrade Utility*, page 27 for a step-by-step guide on upgrading the firmware. In summary, do the following steps:

1. Push and hold the *Operation Mode* pushbutton and power on the Local or Remote unit to enter the firmware upgrade mode.
2. Connect a computer to the RS-232 port of the local/remote unit.
3. Use ATEN Firmware upgrade utility to do the firmware upgrade.

Note: Do these steps for the Local and Remote units individually.

LED Display

The CE774 / CE775 Local and Remote Units have front panel LEDs to indicate their operating status, as shown in the tables, below:

CE774L / CE775L (Local Unit)

LED	Indication
Local (Green)	Lights when the local console is active (the Remote LED is off). <ul style="list-style-type: none">◆ Lights also when in Hotkey Setting Mode. The remote console's keyboard and mouse are disabled.◆ If no HSM key is detected after 5 seconds, device goes on Auto operating mode and LED turns off. Turns off when the remote console is active (the Remote LED turns on). Flashes when in Auto operating mode.
Remote (Green)	Lights when the remote console is active (the Local LED is off). Turns off when the local console is active (the Local LED turns on). Flashes when in Auto operating mode.

CE774R / CE775R (Remote Unit)

LED	Indication
Link (Green)	Lights to indicate that the connection to the Local unit is active. Flashes when there is a problem with the connection to the Local unit and the "Remote LED" is off.
Remote (Green)	Lights to indicate that the remote console is active. Turns off when the local console is active. Flashes when in Auto operating mode.

Hotkey Setting Mode

The administrator and users can use hotkey combinations to configure a number of the USB Dual View KVM Extender with Deskew's working environment parameters. All Hotkey operations begin by invoking Hotkey Setting Mode (HSM).

Invoking HSM

To invoke HSM (CE774L / CE775L only), do the following:

1. Hold down **[Ctrl]**.
2. Press and release **[F12]**.
3. Release **[Ctrl]**.

Note: There is an alternative key combination to invoke HSM (see *Alternate HSM Invocation Keys*, page 22).

When Hotkey Mode is active:

- ◆ The Caps Lock, and Scroll Lock LEDs flash in succession to indicate that HSM is in effect. They stop flashing and revert to normal status when you exit HSM.
- ◆ A Command Line appears on the monitor screen. The command line prompt is the word *Hotkey*: in yellow text on a blue background. Hotkey information that you key in displays on the command line.
- ◆ Ordinary keyboard and mouse functions are suspended – only Hotkey compliant keystrokes and mouse clicks (described in the sections that follow), can be input.
- ◆ At the conclusion of some hotkey operations, you automatically exit hotkey mode. With some operations, you must exit manually. To exit HSM manually, press **[Esc]** or **[Spacebar]**.

Alternate HSM Invocation Keys

An alternate set of HSM invocation keys is provided in case the default set conflicts with programs running on the computers.

To switch to the alternate HSM invocation set, do the following:

1. Invoke HSM (see page 21).
2. Press and release **[H]**.

The HSM invocation keys become the Num Lock key (instead of Ctrl) and the minus key (instead of F12).

Note: This procedure is a toggle between the two methods. To revert back to the original [Ctrl] [F12] method, invoke HSM, then press and release the **H** key again.

Keyboard Operating Platform

The CE774 / CE775's default configuration is for a PC Compatible keyboard operating platform. If you have a Mac or a Sun on your installation, you can change the keyboard operating platform as follows:

3. Invoke HSM (see page 21).
4. Press and release the appropriate Function key (see table).

Key	Operation
[F1]	Sets the PC compatible keyboard operating platform for the port that currently has the KVM focus.
[F2]	Enables Mac keyboard emulation.
[F3]	Enables Sun keyboard emulation.
[F4]	Print out the KVM's current settings and quit the Setting mode.

Note: 1. The brackets indicate the keys you should press. Simply press the indicated keys – do not type the brackets.

2. After completing a setting, you automatically exit HSM.

Hotkey Summary Table

After invoking HSM (see page 21), key in one of the following keys to perform the corresponding function:

Key	Function
[H]	Toggles between the default ([Ctrl] [F12]) and alternate ([Num Lock] [-]) Hotkey invocation keys.
[F1]	Sets the PC compatible keyboard operating platform for the port that currently has the KVM focus.
[F2]	Sets the Mac compatible keyboard operating platform for the port that currently has the KVM focus.
[F3]	Sets the Sun keyboard operating platform for the port that currently has the KVM focus.
[F4]	Print out the KVM's current settings and quit the Setting mode.
[O] or [o]	Enable Deskew OSD and exit HSM.
[P] or [p]	Disable the Deskew OSD and exit HSM. (The Deskew OSD is disabled by default.)
[R] or [r]	Reset settings to the default values, as follows: <ul style="list-style-type: none"> ◆ Invoking HSM: [Ctrl] + [F12] ◆ OS Setting: PC Compatible OS ◆ Deskew OSD: Disabled
[Esc] or [Spacebar]	Exit HSM.

Note: The brackets indicate the keys you should press. Simply press the indicated keys – do not type the brackets.









This Page Intentionally Left Blank

Chapter 4

Keyboard Emulation

Mac Keyboard







The PC compatible (101/104 key) keyboard can emulate the functions of the Mac keyboard. The emulation mappings are listed in the table below.

PC Keyboard	Mac Keyboard
[Shift]	Shift
[Ctrl]	Ctrl
	
[Ctrl] [1]	
[Ctrl] [2]	
[Ctrl] [3]	
[Ctrl] [4]	
[Alt]	Alt
[Print Screen]	F13
[Scroll Lock]	F14
	=
[Enter]	Return
[Backspace]	Delete
[Insert]	Help
[Ctrl] 	F15

Note: When using key combinations, press and release the first key (Ctrl), then press and release the activation key.

Sun Keyboard

The PC compatible (101/104 key) keyboard can emulate the functions of the Sun keyboard when the Control key [Ctrl] is used in conjunction with other keys. The corresponding functions are shown in the table below.

PC Keyboard	Sun Keyboard
[Ctrl] [T]	Stop
[Ctrl] [F2]	Again
[Ctrl] [F3]	Props
[Ctrl] [F4]	Undo
[Ctrl] [F5]	Front
[Ctrl] [F6]	Copy
[Ctrl] [F7]	Open
[Ctrl] [F8]	Paste
[Ctrl] [F9]	Find
[Ctrl] [F10]	Cut
[Ctrl] [1]	
[Ctrl] [2]	
[Ctrl] [3]	
[Ctrl] [4]	
[Ctrl] [H]	Help
	Compose
	

Note: When using key combinations, press and release the first key (Ctrl), then press and release the activation key.

Chapter 5

The Firmware Upgrade Utility

The Windows-based Firmware Upgrade Utility provides a smooth, automated process for upgrading the KVM extender's firmware.

The Utility comes as part of a Firmware Upgrade Package that is specific for each device. New firmware upgrade packages are posted on our web site as new firmware revisions become available. Check the web site regularly to find the latest packages and information relating to them:

<http://www.aten.com>

Before You Begin

To prepare for the Firmware Upgrade, do the following:

1. Using a computer connected to the Local or Remote Unit, go to our Internet support site and choose the model name of your device (CE774 / CE775) to get a list of available Firmware Upgrade Packages.

Note: You can only update one CE774 / CE775 unit at a time (Local Unit or Remote Unit); the Firmware Upgrade Utility varies for each.

2. Choose the Firmware Upgrade Package you want to install (usually the most recent), and download it to your computer.
3. Push and hold the *Operation Mode* pushbutton and power on the front panel of the Local or Remote unit to enter the firmware upgrade mode.
4. Use the a Serial RS-232 cable to connect a COM port on your computer to the CE774L / CE775L or CE774R / CE775R RS-232 port.

Note: The Serial RS-232 cable is not provided in the package.

Starting the Upgrade

To upgrade your firmware:

1. Run the downloaded Firmware Upgrade Package file – either by double clicking the file icon, or by opening a command line and entering the full path to it.

The Firmware Upgrade Utility Welcome screen appears:

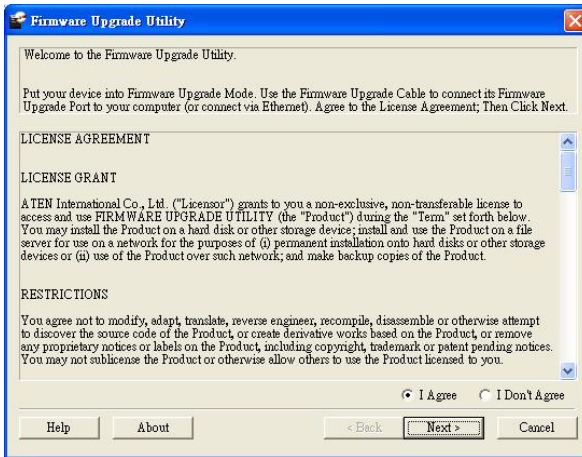

Note: The screens shown in this section are for reference only. The wording and layout of the actual screens put up by the Firmware Upgrade Utility may vary slightly from these examples.

2. Read and agree to the **License Agreement** (enable the **I Agree** radio button).

- Click **Next** to continue. The Firmware Upgrade Utility main screen appears:

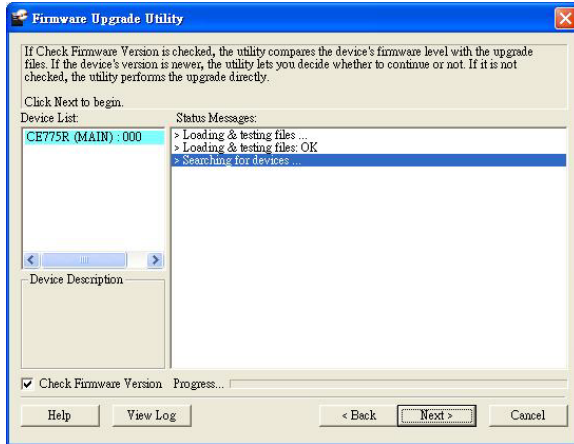

The Utility inspects your installation. The Local or Remote Unit is listed in the **Device List** panel and automatically selected for upgrade.

- Click **Next** to perform the upgrade.

If you enabled **Check Firmware Version**, the Utility compares the device's firmware level with that of the upgrade files. If it finds that the device's version is higher than the upgrade version, it brings up a dialog box informing you of the situation and gives you the option to continue the upgrade (**Y** or **N**)

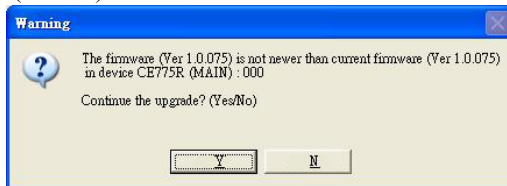

If you did not enable **Check Firmware Version**, the Utility installs the upgrade files without checking whether or not they are a higher level.

5. As the upgrade proceeds, status messages appear in the **Status Messages** panel, and the progress toward completion is shown on the **Progress...** bar.

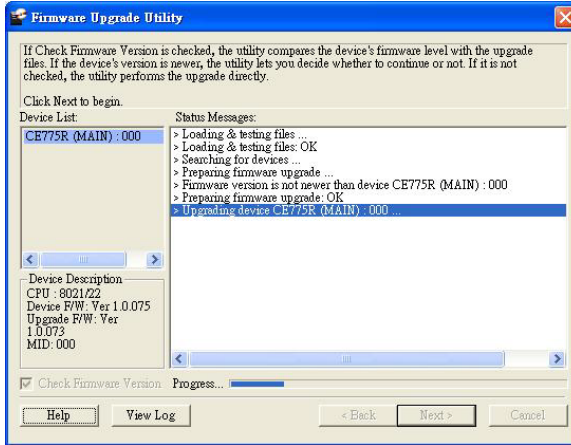

The highlight / color of the device name in the **Device List** panel also changes as follows:

- ◆ Green - the device is being prepared for upgrade
- ◆ Blue - firmware upgrade is in progress
- ◆ Magenta - firmware upgrade is successful

Upgrade Succeeded

After the upgrade has completed, a screen appears to inform you that the procedure was successful:

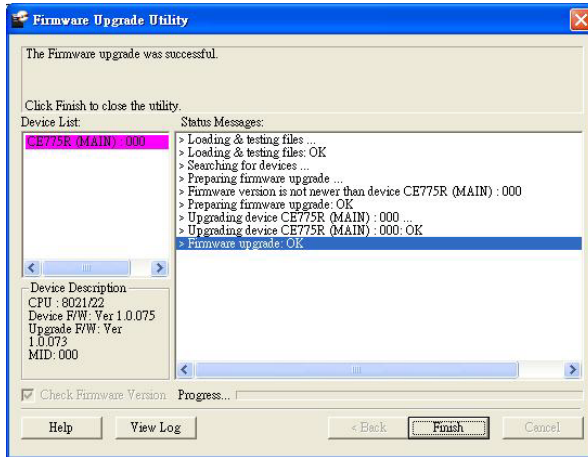

1. Click **Finish** to close the Firmware Upgrade Utility.
2. After successfully upgrading the firmware, unplug the unit's power adapter.
3. Plug in the unit's power adapter to turn it on.

Upgrade Failed

If the *Upgrade Succeeded* screen does not appear, then the upgrade failed to complete successfully. You should repeat the upgrade procedure from the beginning.

This Page Intentionally Left Blank

Safety Instructions

General

- ◆ This product is for indoor use only.
- ◆ Read all of these instructions. Save them for future reference.
- ◆ Follow all warnings and instructions marked on the device.
- ◆ Do not place the device on any unstable surface (cart, stand, table, etc.). If the device falls, serious damage will result.
- ◆ Do not use the device near water.
- ◆ Do not place the device near, or over, radiators or heat registers.
- ◆ The device cabinet is provided with slots and openings to allow for adequate ventilation. To ensure reliable operation, and to protect against overheating, these openings must never be blocked or covered.
- ◆ The device should never be placed on a soft surface (bed, sofa, rug, etc.) as this will block its ventilation openings. Likewise, the device should not be placed in a built in enclosure unless adequate ventilation has been provided.
- ◆ Never spill liquid of any kind on the device.
- ◆ Unplug the device from the wall outlet before cleaning. Do not use liquid or aerosol cleaners. Use a damp cloth for cleaning.
- ◆ The device should be operated from the type of power source indicated on the marking label. If you are not sure of the type of power available, consult your dealer or local power company.
- ◆ The device is designed for IT power distribution systems with 230V phase-to-phase voltage.
- ◆ To prevent damage to your installation, it is important that all devices are properly grounded.
- ◆ The device is equipped with a 3-wire grounding type plug. This is a safety feature. If you are unable to insert the plug into the outlet, contact your electrician to replace your obsolete outlet. Do not attempt to defeat the purpose of the grounding-type plug. Always follow your local/national wiring codes.
- ◆ Do not allow anything to rest on the power cord or cables. Route the power cord and cables so that they cannot be stepped on or tripped over.

- ◆ If an extension cord is used with this device make sure that the total of the ampere ratings of all products used on this cord does not exceed the extension cord ampere rating. Make sure that the total of all products plugged into the wall outlet does not exceed 15 amperes.
- ◆ To help protect your system from sudden, transient increases and decreases in electrical power, use a surge suppressor, line conditioner, or un-interruptible power supply (UPS).
- ◆ Position system cables and power cables carefully; Be sure that nothing rests on any cables.
- ◆ Never push objects of any kind into or through cabinet slots. They may touch dangerous voltage points or short out parts resulting in a risk of fire or electrical shock.
- ◆ Do not attempt to service the device yourself. Refer all servicing to qualified service personnel.
- ◆ If the following conditions occur, unplug the device from the wall outlet and bring it to qualified service personnel for repair.
 - ◆ The power cord or plug has become damaged or frayed.
 - ◆ Liquid has been spilled into the device.
 - ◆ The device has been exposed to rain or water.
 - ◆ The device has been dropped, or the cabinet has been damaged.
 - ◆ The device exhibits a distinct change in performance, indicating a need for service.
 - ◆ The device does not operate normally when the operating instructions are followed.
- ◆ Only adjust those controls that are covered in the operating instructions. Improper adjustment of other controls may result in damage that will require extensive work by a qualified technician to repair.
- ◆ Do not connect the RJ-11 connector marked “UPGRADE” to a public telecommunication network.

Rack Mounting

- ◆ Before working on the rack, make sure that the stabilizers are secured to the rack, extended to the floor, and that the full weight of the rack rests on the floor. Install front and side stabilizers on a single rack or front stabilizers for joined multiple racks before working on the rack.
- ◆ Always load the rack from the bottom up, and load the heaviest item in the rack first.
- ◆ Make sure that the rack is level and stable before extending a device from the rack.
- ◆ Use caution when pressing the device rail release latches and sliding a device into or out of a rack; the slide rails can pinch your fingers.
- ◆ After a device is inserted into the rack, carefully extend the rail into a locking position, and then slide the device into the rack.
- ◆ Do not overload the AC supply branch circuit that provides power to the rack. The total rack load should not exceed 80 percent of the branch circuit rating.
- ◆ Make sure that all equipment used on the rack – including power strips and other electrical connectors – is properly grounded.
- ◆ Ensure that proper airflow is provided to devices in the rack.
- ◆ Ensure that the operating ambient temperature of the rack environment does not exceed the maximum ambient temperature specified for the equipment by the manufacturer.
- ◆ Do not step on or stand on any device when servicing other devices in a rack.

Technical Support

Technical support is available both by email and online (with a browser over the web):

International

- ◆ For online technical support – including troubleshooting, documentation, and software updates: **<http://support.aten.com>**
- ◆ For telephone support, see *Telephone Support*, page iv:

North America

Email Support		support@aten-usa.com
Online Technical Support	Troubleshooting Documentation Software Updates	http://support.aten.com
Telephone Support		1-888-999-ATEN ext 4988

When you contact us, please have the following information ready beforehand:

- ◆ Product model number, serial number, and date of purchase.
- ◆ Your computer configuration, including operating system, revision level, expansion cards, and software.
- ◆ Any error messages displayed at the time the error occurred.
- ◆ The sequence of operations that led up to the error.
- ◆ Any other information you feel may be of help.

Specifications

Function		CE774L	CE774R		
Connectors	Console Ports	Keyboard	1 x USB Type A Female (White)		
		Video	2 x HDB-15 Female (Blue)		
		Mouse	1 x USB Type A Female (White)		
		Speakers	1 x Mini Stereo Jack Female (Green)		
		Mic.	1 x Mini Stereo Jack Female (Pink)		
		Main	1 x RJ-45 Female		
		Sub	1 x RJ-45 Female		
	KVM Ports	KB / Video / Mouse	1 x SPHD-17 Female (Yellow)	N/A	
		Speakers	1 x Mini Stereo Jack (Green)		
		Mic.	1 x Mini Stereo Jack (Pink)		
		VGA Input	1 x HDB-15 Male (Blue)		
	RS-232		1 x DB-9 Female (Black)	1 x DB-9 Male (Black)	
	Power		1 x DC Jack (Black)		
	Switches	Operating Mode Selection		1 x Pushbutton	
Wakeup PC		N/A	1 x Pushbutton		
Video Adjustment Port Selection		N/A	1 x Slide Switch		
Video Gain Tuner		N/A	1 x Recessed Tuner		
Video Compensation Tuner		N/A	1 x Recessed Tuner		
LEDs	Local		1 (Green)	N/A	
	Remote		1 (Green)	1 (Green)	
	Link		N/A	1 (Green)	
Emulation	Keyboard / Mouse		USB		
Video		1920 x 1200 @ 60Hz (30 m); 1600 x 1200 @ 60Hz (150 m)			
Power Consumption		DC5.3V / 4.38W	DC5.3V / 7.95W		
Environment	Operating Temp.		0–50°C		
	Storage Temp		–20–60°C		
	Humidity		0–80% RH, Non-condensing		
Physical Properties	Housing		Metal		
	Weight		0.69 kg	0.69 kg	
	Dimensions (L x W x H)		20.0 x 7.58 x 4.2 cm		

Function		CE775L	CE775R		
Connectors	Console Ports	Keyboard	1 x USB Type A Female (White)		
		Video	2 x HDB-15 Female (Blue)		
		Mouse	1 x USB Type A Female (White)		
		Speakers	1 x Mini Stereo Jack Female (Green)		
		Mic.	1 x Mini Stereo Jack Female (Pink)		
		Main	1 x RJ-45 Female		
		Sub	1 x RJ-45 Female		
	KVM Ports	KB / Video / Mouse	1 x SPHD-17 Female (Yellow)	N/A	
		Speakers	1 x Mini Stereo Jack (Green)		
		Mic.	1 x Mini Stereo Jack (Pink)		
		VGA Input	1 x HDB-15 Male (Blue)		
	RS-232	1 x DB-9 Female (Black)	1 x DB-9 Male (Black)		
	Power	1 x DC Jack (Black)			
Switches	Operating Mode Selection	1 x Pushbutton			
	Wakeup PC	N/A	1 x Pushbutton		
	Video Adjustment Port Selection	N/A	1 x Slide Switch		
	Video Gain Tuner	N/A	1 x Recessed Tuner		
	Video Compensation Tuner	N/A	1 x Recessed Tuner		
	R / G / B Tuner	N/A	3 x Recessed Tuners		
LEDs	Local	1 (Green)	N/A		
	Remote	1 (Green)	1 (Green)		
	Link	N/A	1 (Green)		
Emulation	Keyboard / Mouse	USB			
Video	1920 x 1200 @ 60Hz (150 m); 1280 x 1024 @ 60Hz (300m)				
Power Consumption	DC5.3V / 4.38 W		DC5.3V / 10.27W		
Environment	Operating Temp.	0–50°C			
	Storage Temp	-20–60°C			
	Humidity	0–80% RH, Non-condensing			
Physical Properties	Housing	Metal			
	Weight	0.69 kg	0.69 kg		
	Dimensions (L x W x H)	20.0 x 7.58 x 4.2 cm			

Troubleshooting

Overview

Operation problems can be due to a variety of causes. The first step in solving them is to make sure that all cables are securely attached and seated completely in their sockets.

Problem	Action
No video	Make sure that all cables are securely plugged into their sockets.
Poor quality video	Hot-plug the Cat 5e/6 cable again to trigger the deskew function. The video quality can be improved by using the <i>Gain / Compensation</i> tuners on the CE774R / CE775R to increase or reduce the video signal gain. The video quality can be improved by reducing the refresh rate.

About SPHD Connectors



This product uses SPHD connectors for its KVM and/or Console ports. We have specifically modified the shape of these connectors so that only KVM cables that we have designed to work with this product can be connected.

Limited Warranty

IN NO EVENT SHALL THE DIRECT VENDOR'S LIABILITY EXCEED THE PRICE PAID FOR THE PRODUCT FROM DIRECT, INDIRECT, SPECIAL, INCIDENTAL, OR CONSEQUENTIAL DAMAGES RESULTING FROM THE USE OF THE PRODUCT, DISK, OR ITS DOCUMENTATION.

The direct vendor makes no warranty or representation, expressed, implied, or statutory with respect to the contents or use of this documentation, and especially disclaims its quality, performance, merchantability, or fitness for any particular purpose.

The direct vendor also reserves the right to revise or update the device or documentation without obligation to notify any individual or entity of such revisions, or update. For further inquiries, please contact your direct vendor.