



**Power over the NET™  
PN9108  
User Manual**



[www.aten.com](http://www.aten.com)

## FCC, CE Information

**FEDERAL COMMUNICATIONS COMMISSION INTERFERENCE STATEMENT:** This equipment has been tested and found to comply with the limits for a Class A digital device, pursuant to Part 15 of the FCC Rules. These limits are designed to provide reasonable protection against harmful interference when the equipment is operated in a commercial environment. This equipment generates, uses, and can radiate radio frequency energy and, if not installed and used in accordance with the instruction manual, may cause harmful interference to radio communications. Operation of this equipment in a residential area is likely to cause harmful interference in which case the user will be required to correct the interference at his own expense.

**FCC Caution:** Any changes or modifications not expressly approved by the party responsible for compliance could void the user's authority to operate this equipment.

**CE Warning:** This is a class A product. In a domestic environment this product may cause radio interference in which case the user may be required to take adequate measures.

## SJ/T 11364-2006

The following contains information that relates to China.

部件名称	有毒有害物质或元素					
	铅	汞	镉	六价铬	多溴联苯	多溴二苯醚
电器部件	●	○	○	○	○	○
机构部件	○	○	○	○	○	○

- : 表示该有毒有害物质在该部件所有均质材料中的含量均在SJ/T 11363-2006规定的限量要求之下。
- : 表示符合欧盟的豁免条款, 但该有毒有害物质至少在该部件的某一均质材料中的含量超出SJ/T 11363-2006的限量要求。
- ×: 表示该有毒有害物质至少在该部件的某一均质材料中的含量超出SJ/T 11363-2006的限量要求。



## User Information

---

### Online Registration

Be sure to register your product at our online support center:

International	<a href="http://eservice.aten.com">http://eservice.aten.com</a>
---------------	---

### Telephone Support

For telephone support, call this number:

International	886-2-8692-6959
China	86-10-5255-0110
Japan	81-3-5615-5811
Korea	82-2-467-6789
North America	1-888-999-ATEN ext 4988
United Kingdom	44-8-4481-58923

### User Notice

All information, documentation, and specifications contained in this manual are subject to change without prior notification by the manufacturer. The manufacturer makes no representations or warranties, either expressed or implied, with respect to the contents hereof and specifically disclaims any warranties as to merchantability or fitness for any particular purpose. Any of the manufacturer's software described in this manual is sold or licensed *as is*. Should the programs prove defective following their purchase, the buyer (and not the manufacturer, its distributor, or its dealer), assumes the entire cost of all necessary servicing, repair and any incidental or consequential damages resulting from any defect in the software.

The manufacturer of this system is not responsible for any radio and/or TV interference caused by unauthorized modifications to this device. It is the responsibility of the user to correct such interference.

The manufacturer is not responsible for any damage incurred in the operation of this system if the correct operational voltage setting was not selected prior to operation. PLEASE VERIFY THAT THE VOLTAGE SETTING IS CORRECT BEFORE USE.

## Package Contents

---

The PN9108 package consists of:

- 1 PN9108 Station
- 1 AC Source Power Cord
- 8 Power Outlet Power Cords
- 8 Safe Shutdown Cables
- 1 PON Cable (DB9 F to DB9 M)
- 1 Rack Mount Kit
- 1 Foot Pad Set (4 pcs.)
- 1 Software CD
- 1 User Manual\*
- 1 Quick Start Guide

Check to make sure that all of the components are present and in good order. If anything is missing, or was damaged in shipping, contact your dealer.

Read this manual thoroughly and follow the installation and operation procedures carefully to prevent any damage to the switch or to any other devices on the PN9108 installation.

---

\* Features may have been added to the PN9108 since this manual was printed. Please visit our website to download the most up-to-date version of the manual.

---

Copyright © 2004–2014 ATEN® International Co., Ltd.  
Manual Part No. PAPE-0239-3AXG  
Modification Date: 04/2014

Altusen and the Altusen logo are registered trademarks of ATEN International Co., Ltd. All rights reserved. All other brand names and trademarks are the registered property of their respective owners.

# Contents

---

FCC, CE Information . . . . .	ii
SJ/T 11364-2006 . . . . .	ii
User Information . . . . .	iii
Online Registration . . . . .	iii
Telephone Support . . . . .	iii
User Notice . . . . .	iii
Package Contents . . . . .	iv
About This Manual . . . . .	viii
Conventions . . . . .	ix
Product Information . . . . .	ix
<b>Chapter 1.</b>	
<b>Introduction</b>	
Overview . . . . .	1
Features . . . . .	2
Requirements . . . . .	3
Components . . . . .	4
Front View . . . . .	4
Rear View . . . . .	6
<b>Chapter 2.</b>	
<b>Hardware Setup</b>	
Before You Begin . . . . .	7
Stacking and Rack Mounting . . . . .	7
Stacking . . . . .	7
Rack Mounting . . . . .	8
Single Stage Installation . . . . .	10
Daisy Chaining . . . . .	12
<b>Chapter 3.</b>	
<b>Browser Operation</b>	
Logging In . . . . .	13
The PN9108 Main Screen . . . . .	14
Device Selector . . . . .	15
Device Control . . . . .	15
The Power Status Screen . . . . .	16
The Top Panel . . . . .	16
The Bottom Panel . . . . .	18
<b>Chapter 4.</b>	
<b>Administration</b>	
Working Environment Configuration . . . . .	19
General . . . . .	19
Network . . . . .	21

ANMS .....	24
OOBC .....	25
Date / Time .....	25
Maintenance .....	26
Logout .....	28
Power Management Configuration .....	29
Configuration .....	29
Schedule .....	34
User Management .....	35
Monitor .....	36
Log .....	37

**Chapter 5.**

**Safe Shutdown and Reboot**

Overview .....	39
BIOS Power Management Settings .....	39
Automated Setup .....	40
Installation .....	40
Uninstalling .....	41
Manual Setup .....	42
Windows 2000 / XP / Server 2003: .....	42
NT: .....	44

**Chapter 6.**

**Out of Band Operation**

OOB Configuration .....	45
Computer Connection .....	46
Modem Connection .....	47
Dialog Box Buttons .....	49
Direct Terminal Connection (HyperTerminal) .....	50
HyperTerminal Setup .....	50
Logging In .....	53
Indirect Terminal Connection (HyperTerminal) .....	54
Connection Setup .....	54
Final Check .....	55
Logging In .....	56
Direct Dial In Connection (PPP) .....	57
Connection Setup .....	57
Finishing Up .....	60
Logging In .....	61
Indirect Dial In Connection (PPP) .....	62
Connection Setup .....	62
Finishing Up .....	63
Logging In .....	63
Dial Out Connection .....	64
Connection Setup .....	64

---

Logging In .....	65
Telnet .....	66
Terminal Access .....	66
Browser Access .....	66

## **Chapter 7.**

### **Upgrading The Firmware**

Preparation .....	67
Starting the Upgrade .....	68

## **Appendix**

Safety Instructions .....	69
General .....	69
Rack Mounting .....	71
Consignes de sécurité .....	72
Général .....	72
Montage sur bâti .....	75
Power Cords .....	76
Technical Support .....	77
International .....	77
North America .....	77
IP Address Determination .....	78
Trusted Certificates .....	80
Overview .....	80
Installing the Certificate .....	81
Certificate Trusted .....	82
Self-Signed Private Certificates .....	83
Examples .....	83
Importing the Files .....	83
Troubleshooting .....	84
Overview .....	84
Administrator Login Failure .....	88
Specifications .....	89
Null Modem Cable Diagrams .....	90
Battery Replacement .....	90
Limited Warranty .....	91

## About This Manual

---

This User Manual is provided to help you get the most from your PN9108 system. It covers all aspects of installation, configuration and operation. An overview of the information found in the manual is provided below.

**Chapter 1, Introduction**, introduces you to the PN9108 system. Its purpose, features and benefits are presented, and its front and back panel components are described.

**Chapter 2, Hardware Setup**, provides step-by-step instructions for setting up your installation.

**Chapter 3, Browser Operation**, details the concepts and procedures involved in the browser operation of your PN9108 installation.

**Chapter 4, Administration**, explains the administrative procedures that are employed to configure the PN9108's working environment.

**Chapter 5, Safe Shutdown and Reboot**, shows you how to safely close a system down and reboot your devices without involving the danger to the file systems that simply killing the power supply does.

**Chapter 6, Out of Band Operation**, explains alternative methods to access the in PN9108 case the LAN that it resides on goes down, or it cannot be accessed with the usual browser based method for some reason.

**Chapter 7, Upgrading The Firmware**, explains how to upgrade the PN9108's firmware with the latest available versions.

**An Appendix**, provides specifications and other technical information regarding the PN9108.



## Conventions

This manual uses the following conventions:

- Monospaced      Indicates text that you should key in.
- [ ]      Indicates keys you should press. For example, [Enter] means to press the **Enter** key. If keys need to be chorded, they appear together in the same bracket with a plus sign between them: [Ctrl+Alt].
1.      Numbered lists represent procedures with sequential steps.
- ◆      Bullet lists provide information, but do not involve sequential steps.
- Indicates selecting the option (on a menu or dialog box, for example), that comes next. For example, Start → Run means to open the *Start* menu, and then select *Run*.
-       Indicates critical information.

## Product Information

For information about all ALTUSEN products and how they can help you connect without limits, visit ALTUSEN on the Web or contact an ALTUSEN Authorized Reseller. Visit ALTUSEN on the Web for a list of locations and telephone numbers:

International	<a href="http://www.aten.com">http://www.aten.com</a>
North America	<a href="http://www.aten-usa.com">http://www.aten-usa.com</a>

This Page Intentionally Left Blank

# Chapter 1

## Introduction

### Overview

---

The PN9108 Power over the NET™ is a control unit that provides remote power management for eight AC outlets via a TCP/IP connection, allowing administrators to control the power off, power on, and reboot status for each attached device from any computer connected to the Internet, whether down the hall, or half way around the world.

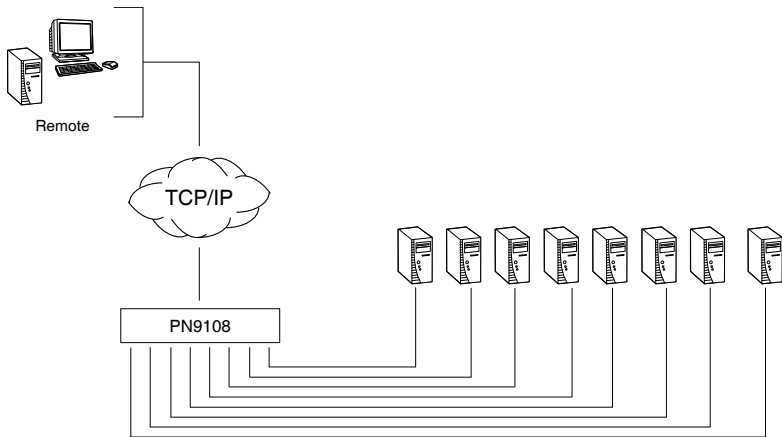

The power status of each outlet can be set individually, allowing users to establish on/off schedules for each device. Up to 15 additional PN9108 Stations can be daisy chained down from the original PN9108, providing remote power management for up to 128 devices. Installation and operation is fast and easy: plugging cables into their appropriate ports and simple GUI management is all that is entailed.

The PN9108's firmware is upgradeable over the Net, so you can stay current with the latest improvements simply by downloading updates from our website.

With its advanced features and ease of operation, the PN9108 is the most convenient, most reliable, and most cost effective way to remotely manage power access for multiple computer installations.

## Features

---

- ◆ Remote power on/off/reboot control for eight outlets via TCP/IP and a built in 10/100 Ethernet port
- ◆ Local power on/off/reboot control via the PN9108's RS-232 port to the computer's RS-232 port
- ◆ Daisy chain up to 15 additional stations to control up to 128 outlets
- ◆ Manual switching between Local and Remote access for each port via front panel push button switches
- ◆ Individual control of each port - users can set the power on sequence and delay time for each port to allow equipment to be turned on in the proper order
- ◆ Easy setup and operation via a browser interface
- ◆ Provides three configuration/management methods: Browser; Telnet; or Console Terminal
- ◆ Safe shutdown and rebooting for Windows systems\*
- ◆ Overcurrent protection and recovery for each AC port (110 V model only) plus total port overcurrent protection (both models) - remote users can monitor the current status via the GUI interface on their browsers
- ◆ Separate circuits for the unit's power and the power to the devices - the power control status menu is still accessible even when an overload condition trips the devices' circuit breaker
- ◆ Cumulative load measurement - remote users can view load information in amperes via the GUI on their browsers
- ◆ On/Off scheduling - allows everything from a one-time start/shutdown, to daily, weekly, etc. starts/shutdowns at user-specified times
- ◆ Port grouping - perform the same action on a specified group of ports
- ◆ Out of Band (OOB) operation via terminal or dialup connection
- ◆ Two level (Administrator and User) security
- ◆ Detachable front panel for convenient rack mounting

---

\* Safe shutdown and rebooting is supported if the *Power Monitor* utility has been installed (see *Automated Setup*, page 40).

---

## Requirements

---

- ◆ Browsers accessing the PN9108 must support SSL 128 bit encryption.
- ◆ For cold booting of attached computers, the computer's BIOS must support this feature.
- ◆ For Safe Shutdown:
  - ◆ The computer must be running Windows (Windows 98 or higher).
  - ◆ The computer's BIOS must support Safe Shutdown.
  - ◆ There must be an available COM port for the Safe Shutdown cable to plug into on the computer.

# Components

## Front View

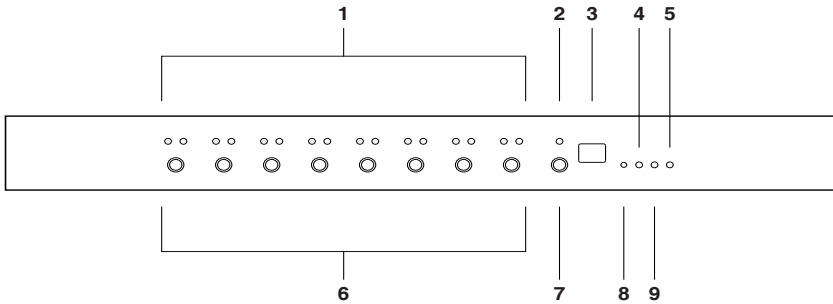

No.	Item	Description
1	Port LEDs	<p>The Port LEDs provide status information about their corresponding AC outlet ports. There is one pair of LEDs for each port. The one on the left is the <i>Remote Access</i> LED; the one on the right is the <i>Power</i> LED:</p> <ul style="list-style-type: none"> <li>◆ A <i>Remote Access</i> LED lights GREEN to indicate that the device attached to its corresponding port is capable of being controlled remotely.</li> <li>◆ A <i>Power</i> LED lights ORANGE to indicate that there is electricity going to its corresponding outlet. The LED flashes under the following conditions: <ul style="list-style-type: none"> <li>◆ If <i>Modem Ring Resume</i> is enabled (see <i>Modem Ring Resume*</i>, page 30), an outlet still receives electricity even when its corresponding computer has been powered OFF. The <i>Power</i> LED blinks OFF, then ON for 8 seconds, then OFF, then ON for 8 seconds, etc., to indicate this situation.</li> <li>◆ When a power status change is pending, the LED flashes until the change has taken place.</li> </ul> </li> <li>◆ If both LEDs flash it indicates that there is either an overcurrent situation, or the relay has failed. See <i>Flashing Lightbulb</i>, page 16, for more details.</li> </ul>
2	Current LED	Lights to indicate that the current status (in amps) is being displayed on the Station ID LED (instead of the Station ID).

(Continues on next page.)

*(Continued from previous page.)*

No.	Item	Description
3	Station ID LED	<ul style="list-style-type: none"> <li>◆ The PN9108's Station ID usually displays here. If this is a Single Station installation (see page 10), or the First Station on a Daisy Chained installation (see page 12), the PN9108 has a Station ID of <b>01</b>.</li> <li>◆ The current status (in amps) displays here (instead of the Station ID) when the <i>Current Display Switch</i> is toggled ON (see item 7, below).</li> </ul>
4	10/100 Mbps Data LED	<ul style="list-style-type: none"> <li>◆ The LED lights ORANGE to indicate 10 Mbps data transmission speed.</li> <li>◆ The LED lights GREEN to indicate 100 Mbps data transmission speed.</li> </ul>
5	Power LED	Lights when the PN9108 is powered up and ready to operate.
6	Power Control Buttons	<p>Each button (A to H), controls the power status of its corresponding AC output port as follows:</p> <ul style="list-style-type: none"> <li>◆ Pressing the button for less than 3 seconds toggles the port between Remote Access enabled and Remote Access disabled (Local Mode). If Remote Access is disabled, the switch does not allow the port to be managed from a remote connection.</li> <li>◆ Under Local Mode, pressing and holding the button in for more than 3 seconds switches the power to its corresponding port On or Off.</li> </ul>
7	Current Display Switch	Toggles between showing the Station ID and current status (in amps) on the Station ID LED.
8	Reset Switch	Pressing and holding this switch in for more that three seconds resets the PN9108 to its factory default settings. This switch is recessed and must be pushed with a thin object, such as the end of a paper clip, or a ballpoint pen.
9	Link LED	Lights GREEN to indicate that a connection via the PN9108's RJ-45 Ethernet port has been established. Flashes to indicate that data is being transmitted.

## Rear View

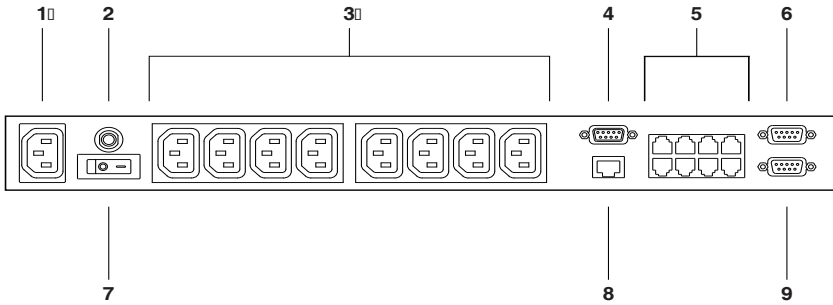

No.	Item	Description
1	Power Socket	The power cable from the AC source plugs in here.
2	Circuit Breaker	Press to reset the circuit.
3	AC Power Outlets	The power cables that connect to the computers plug in here.
4	RS-232 Port	This port can be used to attach a UPS, modem, or PC terminal.
5	Safe Shutdown Ports	Provides safe shutdown and rebooting for Windows 98SE, ME, NT, 2000, XP and 2003 Server systems.
6	PON (Power over the NET™) Output Port	When daisy chaining PN9108 Stations, this is the Chain Out port. See p. 12 for daisy chaining details.
7	Power Switch	This standard rocker switch powers the PN9108 On and Off.
8	RJ-45 Port	The Cat 5 cable that connects the PN9108 to the Internet plugs in here.
9	PON Input Port	In a daisy chained installation, the PON cable from the Chain Out port of the parent unit plugs in here.



# Chapter 2

## Hardware Setup

### Before You Begin

---



1. Important safety information regarding the placement of this device is provided on page 69. Please review it before proceeding.
2. Make sure that power to all the devices you will be connecting up have been turned off. You must unplug the power cords of any computers that have the Keyboard Power On function.

### Stacking and Rack Mounting

---

#### Stacking

The PN9108 can be placed on any appropriate level surface that can safely support its weight plus the weight of its attached cables. To place or stack the PN9108, remove the backing material from the bottom of the rubber feet that came with this package, and stick them onto the switch's bottom panel at the corners, as shown in the diagram, below

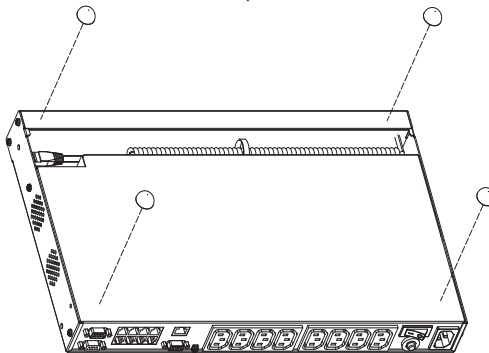

---

**Note:** To ensure adequate ventilation, allow at least 5.1 cm on each side, and 12.7cm at the back for power cord and cable clearance.

---

## **Rack Mounting**

The PN9108 can be installed in most standard 19" (1U) racks. To rack mount the unit do the following:

1. Separate the front and rear modules by removing the four module attaching screws:

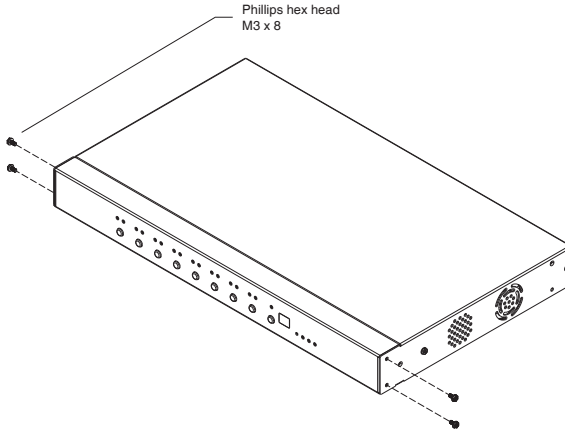

2. Use the screws you just removed, and the ones supplied with the rack mounting kit to screw the rack mounting brackets into both modules:

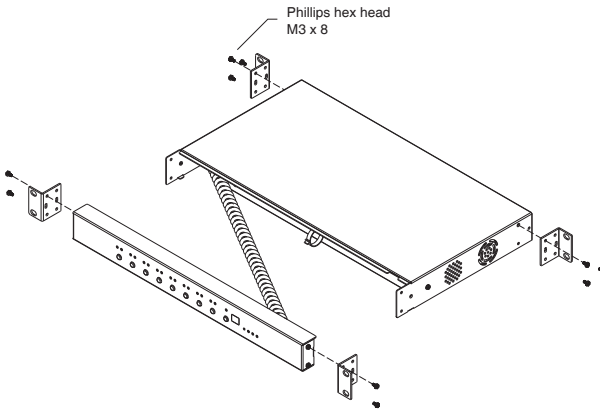

3. Position the device in the rack and align the holes in the mounting brackets with the hole in the rack.
4. Screw the mounting brackets to the rack.

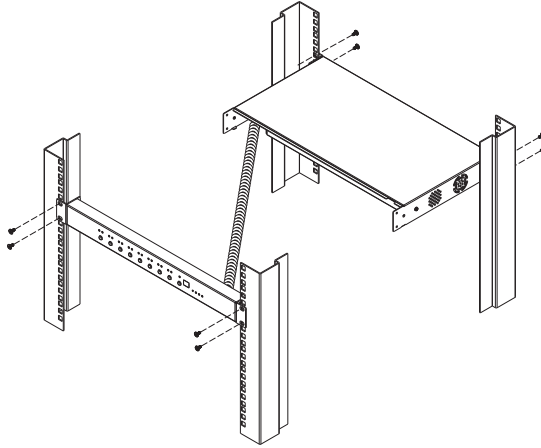

---

**Note:** Cage nuts are provided for racks that are not prethreaded.

---

## **Single Stage Installation**

In a Single Stage installation, there are no additional PN9108 Stations daisy chained down from the first unit. To set up a single stage installation, refer to the installation diagram below (the numbers in the diagram correspond to the numbered steps), and do the following:

1. For each device, use an AC Output cable to connect from any available PN9108 output port to the device's AC socket.
2. Safe Shutdown is supported for computers running Windows 98SE, ME, NT, 2000, XP, and 2003 Server.

If you choose to utilize the Safe Shutdown feature (use of this feature is optional), for each computer use a Safe Shutdown cable to connect from the PN9108's Safe Shutdown port to the computer's Serial port.

---

**Note:** You must connect the computer to the same letter designation for both the AC Outlet and Safe Shutdown port.

---

3. Plug the LAN or WAN cable into the PN9108's RJ-45 socket.
4. If you choose to use a UPS, or a modem or PC for OOB operation, connect its serial port to the PN9108's RS-232 port.
5. Use the AC power cord provided with this package to connect the PN9108's Power Socket to an AC power source. See p. 76 for power cord safety information.

Once you are cabled up, you can turn on the PN9108 and the connected devices.

- 
- Note:**
1. We strongly advise that you do not plug the PN9108 into a multi socket extension cord, since it may not receive enough amperage to operate correctly.
  2. We strongly recommend using cable ties and cable bars to safely and securely route the cables attached to the back of the unit.
-

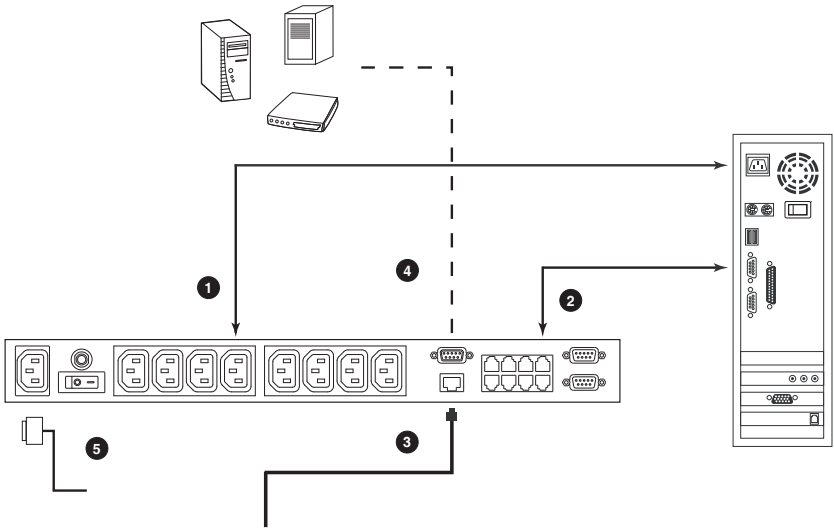

## Daisy Chaining

To manage even more devices, up to 15 additional PN9108 Stations can be daisy chained down from the top level unit. In this way, up to 128 devices can be managed on a complete installation. To set up a daisy chained installation do the following:

1. For each PN9108 Station that you add to the chain, use the DB-9 to DB-9 PON cable that was provided with it to connect the parent PN9108's PON OUT port to the child PN9108's PON IN port.

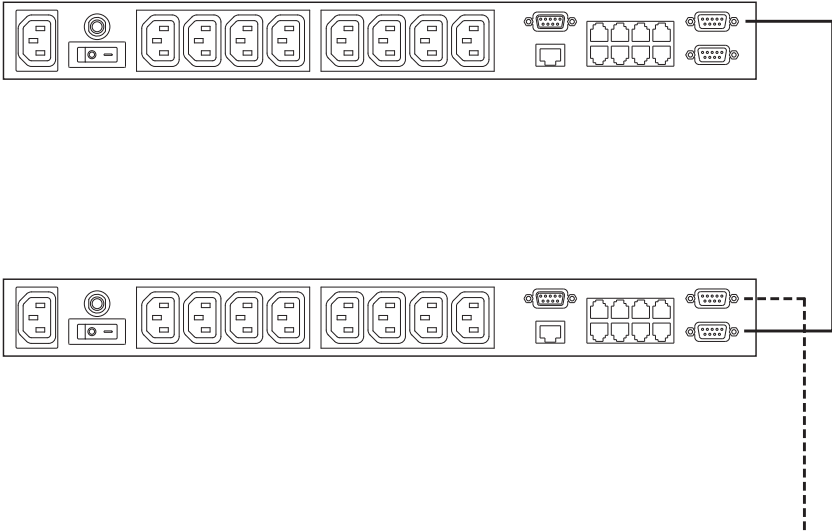

2. Power up the daisy chained PN9108 Stations in sequence starting with the highest level Station and working down. In each case, wait for the PN9108's Station ID to be ascertained and displayed on the Station ID LED before powering on the next unit.

The Station ID for First Stage (top level) unit is **01**; the ID for the Second Stage unit is **02**, etc.

3. After all the PN9108 Stations are up, power on the devices.

# Chapter 3

## Browser Operation

### Logging In

---

The PN9108 is accessed with an internet browser.

---

**Note:** Browsers accessing the PN9108 must support SSL 128 bit encryption.

---

1. Open your browser and specify the IP address of the PN9108 you want to access in the browser's URL location bar.

---

**Note:** 1. Get the IP address from the PN9108 administrator

2. If you are the administrator, and are logging in for the first time, the various ways to determine the PN9108's IP address are described in the Appendix on page 78.
- 

2. When the Security Alert dialog box appears, accept the certificate – it can be trusted. (See *Trusted Certificates*, page 80, for details.) The Login page appears:

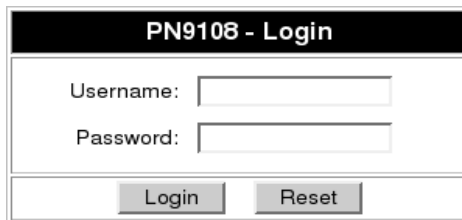

The image shows a web browser window displaying the login page for a PN9108 device. The page has a black header with the text "PN9108 - Login" in white. Below the header, there are two input fields: "Username:" and "Password:". At the bottom of the page, there are two buttons: "Login" and "Reset".

3. Provide a valid Username and Password (set by the PN9108 administrator), then Click **Login** to continue.

---

**Note:** If you are the administrator, and are logging in for the first time, use the default Username: *administrator*; and the default Password: *password*. For security purposes, we strongly recommend you remove these and give yourself a unique Username and Password (see *Administrator*., page 20).

---

## The PN9108 Main Screen

After you have successfully logged in, the PN9108 Main Screen appears:

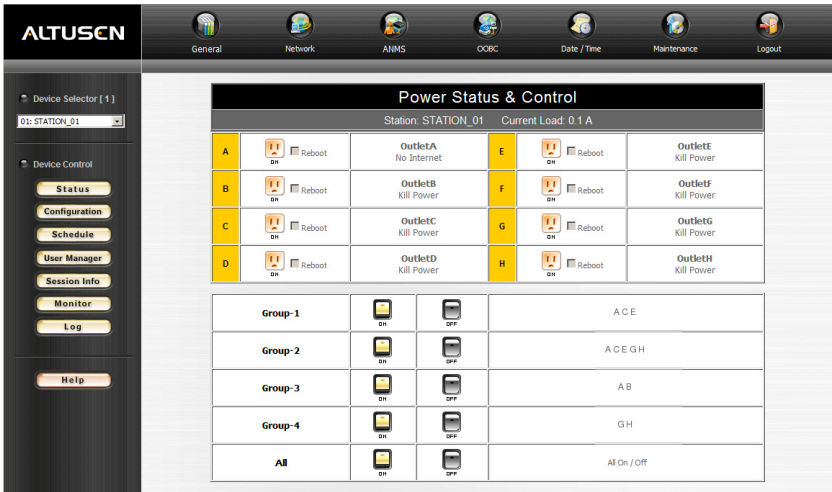

- ◆ The icons arranged horizontally across the top are used by the administrator to configure the PN9108's working environment. Administrative functions are explained in Chapter 4.
- ◆ The bar along the left side is used to configure and control each of the PN9108 Stations on your installation. Regular users manage the devices they have permission for with the Device Selector and the Status button. The other buttons in this bar are for the administrator to configure the power management environment.
- ◆ When you first start up, the *Power Status* screen of the First Station appears in the large central panel. The power management operations for the devices attached to the Station's outlets are made here.

---

**Note:** Clicking the *Altusen* logo at the top left of the page will take you to Altusen's web site.

---



---

## Device Selector

---

Since up to 16 PN9108 Stations can be daisy chained, this panel lists each of the Stations on your installation. The number in brackets, to the right of the title, indicates the total number of stations on the installation.

The names of the Stations are listed in the list box below the title. To select a Station for power management, click on the arrow to drop the list down; then click to select the Station you want to work with. When you select a Station, its Power Status screen appears.



- 
- Note:**
1. Each PN9108's *Station ID* is displayed in the Station ID LED on its front panel.
  2. The outlets in the Power Status panels are for the Station currently selected in the Device Selector.
  3. Clicking the *Altusen* logo will take you to the Altusen web page.
- 

## Device Control

---









With the exception of *Status*, the buttons in the *Device Control* panel are used by the Administrator to configure the power management options of the Station that is currently selected in the *Device Selector* panel. These functions are explained in Chapter 4.

Clicking the *Status* button brings up the Power Status screen for the currently selected device (see *Device Selector*, above). The Power Status Screen is discussed in the next section.



## The Power Status Screen

### The Top Panel

Power Status & Control					
Station: PN9108 - No.4    Current Load: 0.1 A					
A		<b>Outlet-A</b> Non Internet	E		<b>OutletE</b> AC Back
B		<b>OutletB</b> Kill Power	F		<b>OutletF</b> Kill Power
C		<b>OutletC</b> Modem Ring	G		<b>OutletG</b> Modem Ring
D		<b>OutletD</b> Kill Power	H		<b>OutletH</b> Non Internet

#### Power Buttons:

The top panel of the Power Status screen is divided into eight subareas which correspond to the A- H outlets on the PN9108's rear panel.

Each subarea is composed of a socket icon that functions as the Power Button for its corresponding outlet, and an information panel to its right. Clicking the socket icon turns the power status of the computer attached to its outlet On or Off. The icon and the label under it inform you of the power status as shown in the following table:

Indication	Status
Steady Gray	Power to the outlet is OFF.
Flashing Gray	Power to the outlet is OFF but <i>Modem Ring Resume</i> has been specified as the remote power option (see <i>Modem Ring Resume*</i> , page 30, for details).
Flashing Yellow	A change in the outlet's power status is pending. See <i>Modem Ring Resume*</i> and <i>System after AC Back*</i> , page 30, for details.
Steady Amber	Power to the outlet is ON.
Flashing Lightbulb	Indicates that the outlet is either experiencing an overcurrent situation, or the relay has failed. Click the icon to recover. If the port recovers successfully, it returns to the status it was at before it failed, and the icon changes to reflect the recovered status. If the port cannot recover, contact Altusen technical support.

**The Information Panel:**

The information panel shows the Outlet's name and currently selected power option. These parameters are set by the Administrator with the *Configuration* function (see page 29 for details).

**Reboot:**











If *Reboot* is enabled (by putting a check in the checkbox), the computer attached to the Outlet's corresponding port will reboot instead of shutting off when the Power Button is clicked to turn the outlet off. This selection is disabled (grayed out) if the Outlet isn't configured for a Safe Shutdown capable option. See *Configuration*, page 29, for further details.

---

**Note:** This function only works with computers capable of a Safe Power Shutdown. See step 2 of *Single Stage Installation*, page 10.

---

## The Bottom Panel

<b>Group-1</b>	 ON	 OFF	A C E
<b>Group-2</b>	 ON	 OFF	A C E G H
<b>Group-3</b>	 ON	 OFF	A B
<b>Group-4</b>	 ON	 OFF	G H
<b>All</b>	 ON	 OFF	All On / Off

The bottom panel allows you to control the power status of your outlet groups.

Outlets can be placed into groups so that Power On/Off actions can be carried out on the entire outlet group at the same time, rather than performing the same action on each outlet individually. Clicking the group's *On* or *Off* Power Button (the rocker switch icon) performs the power action that was set by the administrator for each of the outlets.

- 
- Note:**
1. Users must have permission to operate all the ports in a group in order to use this function. If a user doesn't have permission to operate any port in the group, clicking the Power Button has no effect.
  2. If some ports in a group are ON and some are OFF, and you click the OFF button, the ports that are ON turn OFF. The ports that are OFF remain OFF.
- 

Details about creating and configuring power outlet groups are described in the *Configuration* section of the Administration chapter (see page 29).

# Chapter 4 Administration

## Working Environment Configuration

---

The icon bar at the top of the main screen is used by the administrator to configure the PN9108's working environment.



An explanation of each of the configuration functions is given in the sections that follow.

### General

When you click the *General* icon, the following dialog box appears:

### General Settings

**System Information**

Name:

Description:

---

**Administrator**

Name:

Password:

Confirm Password:

---

**Connection Control**

Session timeout:  minute(s)

No timeout on monitoring

**System Information:**

The System Information section allows you to provide a name and description for the PN9108 installation. Providing a name and description is optional, but makes it convenient for system operators to distinguish among installation groups in large, installations when there are several groups of daisy chained PN9108s

The name can be up to 30 characters.

---

**Note:** This name is not the same as the Station Name which is set in the *Configuration* dialog box (see page 29).

---

**Administrator:**

This section sets the administrator's login name and password.

- ♦ The default administrator name is: *administrator*
- ♦ The default password is: *password*

For security purposes, we strongly recommend that you change the default values to something unique. The minimum number of alphanumeric characters for both is 4; the maximum number is 15.

**Connection Control:**

- ♦ *Session Timeout* sets a timeout value. If there is no input from the logged in operator for the amount of time set with this function, the operator is automatically logged out and the session is terminated. Valid settings are from 2—99 minutes. The default is 3 minutes. A setting of 0 (zero) disables this function.
- ♦ If *No timeout on monitoring* is enabled, the system will not time out when you are using the Monitor function to view the power status of your installation (see page 36 for details).

## Network

Network Settings allows you to choose how the PN9108 functions on the network.

**Network Settings**

Fixed IP Address       DHCP Enable

---

**Network Settings**

IP Address:

Gateway Address:

Subnet Mask:

---

**Service Ports**

HTTP:

HTTPS:

Telnet:

---

**DNS Settings**

Domain Name Server:

Host Name:

---

**IP Installer Settings**

Enabled

View Only

Disabled

### IP Address Settings:

- ◆ Fixed IP Address:
 

To give the PN9108 a fixed IP address, select the *Fixed IP Address* radio button, and fill in the *Network Settings* fields with values appropriate to the network you are on.
- ◆ Dynamic IP Address:
 

The PN9108's default setting is to obtain its IP address automatically from a DHCP server (the *DHCP Enable* radio button is selected). When the PN9108 starts, it waits to get an address from a DHCP server. If, after one minute, it fails to obtain an address from the DHCP server, it reverts to its default IP address of 192.168.0.60.

---

**Note:** If the PN9108 is on a network that uses DHCP to assign network addresses, and you don't know what the address is, there are several methods you can use to ascertain it. See *IP Address Determination*, page 78 for details.

---

When the *DHCP Enable* radio button is selected, the fields in the Network Settings section are disabled, and a *Mail Configuration* panel appears:

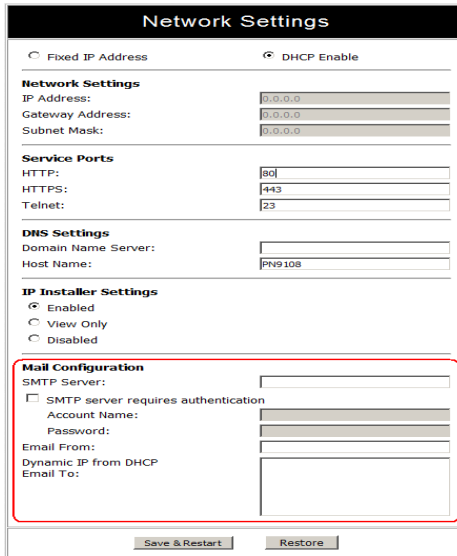

The screenshot shows the 'Network Settings' dialog box. At the top, there are two radio buttons: 'Fixed IP Address' (unselected) and 'DHCP Enable' (selected). Below this, the 'Network Settings' section is disabled, showing fields for IP Address, Gateway Address, and Subnet Mask, all with placeholder values '0.0.0.0'. The 'Service Ports' section is also disabled, with fields for HTTP (80), HTTPS (443), and Telnet (23). The 'DNS Settings' section is disabled, with fields for Domain Name Server and Host Name (PN9108). The 'IP Installer Settings' section has three radio buttons: 'Enabled' (selected), 'View Only', and 'Disabled'. The 'Mail Configuration' panel is highlighted with a red border and contains the following fields: SMTP Server, a checkbox for 'SMTP server requires authentication', Account Name, Password, Email From, Dynamic IP from DHCP, and Email To. At the bottom of the dialog are 'Save & Restart' and 'Restore' buttons.

1. Key in the domain name or IP address of the SMTP mail server for your network in the top field.
2. If your server requires authentication, check the *SMTP server requires authentication* checkbox and key in your account name and password in the fields provided.
3. Key in the address of your email account in the *Email From* field.
4. Key in the email addresses of the users you want to receive the IP address in the bottom field. This field can only accept 128 total characters. Addresses can be comma, semicolon, or spacebar delimited.
5. When you are all done, click **Save and Restart** to close the dialog box and reset the PN9108.

---

**Note:** Be sure that the DNS setting field is filled in with a value appropriate to the network you are on.

---



**Service Ports:**

The values shown in the dialog box are the default settings. If you change them, users must specify the port as part of the URL when logging in. If you change the http port to 81, for example, users must log in as follows:

```
http://10.0.100.65:81
```

**IP Installer Settings:**

To help determine and/or set an IP address for a PN9108 an IP Installer utility has been included on the PN9108 software CD. (See *IP Address Determination*, page 78 for operation details.) The meanings of the settings are described in the following table:

Enabled	Users can see the current IP address for the PN9108, and can change its settings with the utility.
View Only	Users can see the current IP address for the PN9108, but cannot change its settings with the utility.
Disabled	The PN9108 does not show up in the IP Installer's list of devices. It cannot be seen, and cannot be changed.

## **ANMS**

The Authentication Network Management Service dialog box allows you to set up login authorization through a CC (Control Center) server, and enable event trap and notification for specified events.

**Authentication Network Management Service**

**CC Management Settings**

Enable CC Management

CC Server IP:

CC Server Port:

Enable Event Trap and Notify:

System Power On

System Restart

Outlet Fault

UPS Failure

### **CC Management Settings**

If you want to allow authorization for the PN9108 through a CC (Control Center) server, check *Enable CC Management* and fill in the CC Server's IP address and the port that it listens on in the appropriate fields.

### **Enable Event Trap and Notify**

To enable notification of event traps, put a check in the checkbox of the trap events you want notification of. Notification of event traps will be sent through the CC server.

### **Finishing Up**

When you have finished making your entries, click **Save**, to save them.

## OoBC

See Chapter 6, *Out of Band Operation*, page 45

### Date / Time

The Date / Time function allows you to set the PN9108's system date and time. When you click the Date / Time icon, the following dialog box appears:

Date / Time	
<b>Current System Time</b>	
Sys. Date (yyyy-mm-dd)	2004-10-12
Sys. Time (hh:mm:ss)	00:49:55
<b>New System Time</b>	
<input checked="" type="radio"/> Synchronize with computer time	
PC Date (yyyy-mm-dd)	2004-10-12
PC Time ( hh:mm:ss )	16:40:43
<input type="radio"/> Synchronize with NTP server	
Time Zone:	GMT+8 Singapore,Taipei
<input type="checkbox"/> Enable daylight saving time (Summer Time)	
<input type="radio"/> Set manually	
Date (yyyy-mm-dd)	2004-10-12
Time ( hh:mm:ss )	00:48:41
Save	

The date and time settings that the PN9108 is currently set to appear in the upper section. The large lower section offers three methods to set a new system time:

- ◆ Automatically synchronizing the date and time with your computer
- ◆ Obtaining the date and time from an NTP server on the internet
- ◆ Setting the date and time manually.

If you enable *Synchronize with NTP server*, be sure to select the time zone that corresponds to your location from the *Time Zone* list box.

---

**Note:** If you are behind a firewall, you must enable a port for the NTP server.

---

## Maintenance

There are two functions provided under Maintenance: Firmware Upgrade, and Private Certificate.

The screenshot shows a web interface titled "Maintenance". It is divided into two main sections: "Firmware Upgrade" and "Private Certificate".

**Firmware Upgrade**

Firmware File:

Check Firmware Version

---

**Private Certificate**

Private Key:

Certificate:

### Firmware Upgrade

New firmware upgrade packages are posted on our website as they become available. Check the site regularly to find the latest packages.

To upgrade your firmware, do the following:

1. From your computer, go to our Internet support site and download the PN9108 Firmware Upgrade Package.
2. From the computer that you downloaded the upgrade file to, log into the PN9108 and click the Maintenance icon.
3. In the *Firmware Upgrade* panel, click the *Browse* button; navigate to the upgrade file on your computer, and select it.
4. Click **Upgrade** to perform the upgrade.

- 
- Note:**
1. If you enable *Check Firmware Version*, the station's firmware level is compared to the level of the upgrade files. If the PN9108's current version is equal to, or higher than, the upgrade version, the PN9108's version won't be overwritten.
  2. If you do not enable *Check Firmware Version*, the Utility installs the upgrade files without checking whether they are a higher level, or not.
-

## Private Certificate

When logging in over a secure (SSL) connection, a signed certificate is used to verify that the user is logging in to the intended site. For enhanced security, the *Private Certificate* section allows you to use your own private encryption key and signed certificate, rather than the default ATEN certificate.

There are two methods for establishing your private certificate: generating a self-signed certificate; and importing a third-party certificate authority (CA) signed certificate.

### Generating a Self-Signed Certificate

If you wish to create your own self-signed certificate, a free utility – openssl.exe – is available for download over the web. See *Self-Signed Private Certificates*, page 83 for details about using OpenSSL to generate your own private key and SSL certificate.

### Obtaining a CA Signed SSL Server Certificate

For the greatest security, we recommend using a third party certificate authority (CA) signed certificate. To obtain a third party signed certificate, go to a CA (Certificate Authority) website to apply for an SSL certificate. After the CA sends you the certificate, save it to a convenient location on your computer.

### Importing the Private Certificate

To import the private certificate, do the following:

1. Click **Browse** to the right of *Private Key*; browse to where your private encryption key file is located; and select it.
2. Click **Browse** to the right of *Certificate*; browse to where your certificate file is located; and select it.

Click **Upload** to complete the procedure.

## **Logout**

Click the *Logout* icon to end your PN9108 session.

---

**Note:** It is important to log out when you end your session. Otherwise, you must wait until the timeout setting has expired before the PN9108 can be accessed again. (See *Connection Control* under the *General Settings* dialog information, page 19.)

---

## Power Management Configuration

The buttons in the *Device Control* panel allow the PN9108 administrator to configure the power management functions of each of the PN9108 Stations on the installation. The functions provided by each of the buttons are explained in the sections that follow.

**Note:** You must do a separate set up for each Station on your installation.

### Configuration

Clicking the Device Control *Configuration* button brings up the Configuration screen. The screen is composed of three panels:

Configuration							
Station: STATION_01    FW Ver: 1.0.093							
Station Name		STATION_01					
Outlet	Name	Modem Ring Resume	System after AC Back	Kill the Power	Confirmation Required	Power On Delay	Power Off Delay
A	OutletA	<input type="radio"/>	<input type="radio"/>	<input checked="" type="radio"/>	<input type="checkbox"/>	0_sec	0_sec
B	OutletB	<input type="radio"/>	<input type="radio"/>	<input checked="" type="radio"/>	<input type="checkbox"/>	0_sec	0_sec
C	OutletC	<input type="radio"/>	<input type="radio"/>	<input checked="" type="radio"/>	<input type="checkbox"/>	0_sec	0_sec
D	OutletD	<input type="radio"/>	<input type="radio"/>	<input checked="" type="radio"/>	<input type="checkbox"/>	0_sec	0_sec
E	OutletE	<input type="radio"/>	<input type="radio"/>	<input checked="" type="radio"/>	<input type="checkbox"/>	0_sec	0_sec
F	OutletF	<input type="radio"/>	<input type="radio"/>	<input checked="" type="radio"/>	<input type="checkbox"/>	0_sec	0_sec
G	OutletG	<input type="radio"/>	<input type="radio"/>	<input checked="" type="radio"/>	<input type="checkbox"/>	0_sec	0_sec
H	OutletH	<input type="radio"/>	<input type="radio"/>	<input checked="" type="radio"/>	<input type="checkbox"/>	0_sec	0_sec

Outlet Groups		
Group	Name	Outlets in Each Group
Group-1	Group-1	<input type="checkbox"/> A <input type="checkbox"/> B <input type="checkbox"/> C <input type="checkbox"/> D <input type="checkbox"/> E <input type="checkbox"/> F <input type="checkbox"/> G <input type="checkbox"/> H
Group-2	Group-2	<input type="checkbox"/> A <input type="checkbox"/> B <input type="checkbox"/> C <input type="checkbox"/> D <input type="checkbox"/> E <input type="checkbox"/> F <input type="checkbox"/> G <input type="checkbox"/> H
Group-3	Group-3	<input type="checkbox"/> A <input type="checkbox"/> B <input type="checkbox"/> C <input type="checkbox"/> D <input type="checkbox"/> E <input type="checkbox"/> F <input type="checkbox"/> G <input type="checkbox"/> H
Group-4	Group-4	<input type="checkbox"/> A <input type="checkbox"/> B <input type="checkbox"/> C <input type="checkbox"/> D <input type="checkbox"/> E <input type="checkbox"/> F <input type="checkbox"/> G <input type="checkbox"/> H

UPS Pin Assignments and Signal Polarities			
<input type="checkbox"/> Enable UPS			
Power Fail/On Battery:	PS: CTS	<input checked="" type="radio"/> Negative	<input type="radio"/> Positive
Low Battery:	P1: BCD	<input checked="" type="radio"/> Negative	<input type="radio"/> Positive
UPS Shutdown:	PH: DTR	<input checked="" type="radio"/> Negative	<input type="radio"/> Positive

**Warning!**  
Please consult your UPS documentation before attempting to configure pin assignments and signal polarities.

The top Configuration panel allows you to set up a power management configuration for each port. These settings determine what takes place when you click the Power Button On or Off. The meanings of the field headings are given in the following table:

Heading	Meaning
Station Name	To make things more convenient on a multi-station installation, each station can be given a distinctive name. To name a station key in the name of your choice - up to 15 letters and numbers.
Outlet Name	Each outlet can be given a distinctive name. The maximum number of characters is 15.
Modem Ring Resume*	<p>This is a Safe Shutdown and Reboot option (see Chapter 5). If this option is selected, when the Outlet's Power Button is clicked OFF, the PN9108 waits for the amount time set in the <i>Power Off Delay</i> dialog box (see below), and then performs a Safe Shutdown on the computer attached to its Outlet. When the Power Button is clicked ON, the PN9108 waits for the amount time set in the <i>Power On Delay</i> field (see below), and then restarts the computer. The front panel LEDs flash while the action is pending.</p> <p><b>Note:</b> 1. With this option, although the computer has been turned off, it is still receiving power through the outlet. Therefore, the computer can be locally (physically) turned on or off - in which case the computer's status may not correspond with the Outlet Status display. The gray "socket" icon flashes (instead of remains steady) to remind you of this. To make sure that the computer is in sync with the display, click the power On/Off/On (or Off/On/Off) when making a power status change.</p> <p>2. If you experience restarting problems even though you have enabled this feature, see <i>Problem 6:</i>, page 86, in the <i>Troubleshooting</i> section.</p>
System after AC Back*	<p>This is a Safe Shutdown option (see Chapter 5). If this option is selected, when the Outlet's Power Button is clicked OFF, the PN9108 waits for the amount time set in the <i>Power Off Delay</i> dialog box (see below), and then performs a Safe Shutdown on the computer attached to its Outlet.</p> <p>When the Power Button is clicked ON the PN9108 waits for the amount time set in the <i>Power On Delay</i> field (see below), and then restarts the computer.</p> <p><b>Note:</b> With this option power through the Outlet is cut off. Although it was safely shutdown, the computer does not receive any power through the outlet.</p>



(Continued from previous page.)

Heading	Meaning
Kill the Power	If this option is selected, the PN9108 waits for the amount time set in the <i>Power Off Delay</i> field (see below), and then turns the Outlet's power OFF when its Power Button is clicked to turn off the power. Turning the power off performs a cold (non-safe) shutdown. Selecting this function disables the Reboot checkbox on the main screen.
Confirmation Required	If this option is enabled (there is a check in the checkbox), a dialog box comes up asking you to confirm the operation before it is performed. If it is disabled (there is no check in the checkbox), the operation is performed without confirmation.
Power On Delay	Sets the amount of time the PN9108 waits after the Power Button is clicked before it turns on the computer attached to the corresponding outlet.
Power Off Delay	Sets the amount of time the PN9108 waits after the Power Button is clicked before it shuts down the computer attached to the corresponding outlet.  For the <i>System after AC Back</i> option, after the delay time expires, the PN9108 waits another fifteen seconds, then shuts the computer down.  The default delay time is 15 seconds. The maximum delay time is 999 seconds.

To save your settings, click **Save**. To exit without saving your changes, use your browser's *Back* function to go back to the Main web page, or click another button on the page to go to a different function.

\* *Modem Ring Resume* and *System after AC Back* only work with computers capable of a Safe Power Shutdown. See step 2 of *Single Stage Installation*, page 10.

**Outlet Groups:**

The bottom Configuration panel (refer back to page 29) lets you select the outlets that you want to put together as an outlet group. Outlet groups enable control actions to be carried out on the entire group at the same time, rather than repeatedly performing the same action on each individual outlet. You can have four outlet groups per station, and each group can be given a distinctive name. The maximum number of characters for the name is 15.

**UPS:**

- ◆ The PN9108 provides simple signal UPS support. If you connect a UPS to the PN9108's RS-232 port, and enable the UPS function, should the main power be interrupted and the UPS kick in, the PN9108 can initiate a safe shutdown for all of the computers that have been cabled and configured for a safe shutdown.
- ◆ To enable the UPS function:
  - ◆ Put a check in the Enable UPS checkbox
  - ◆ Configure the pin assignments and polarities according to the documentation for your UPS.
  - ◆ Set the power outlet configuration for each of the affected ports to one of the safe shutdown options (see *Modem Ring Resume\** and *System after AC Back\** in the table on page 30).

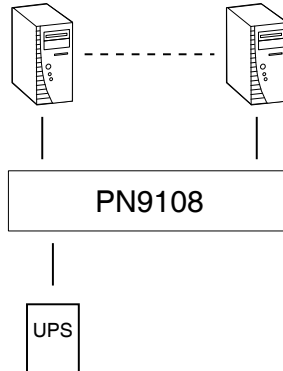

- ◆ It is also possible to attach an individual UPS for each computer to the PN9108's outlet ports. In this case:
  - ◆ Do **not** enable the PN9108's UPS function - since that function only works with a UPS device attached to its RS-232 port.
  - ◆ Configure the UPS devices according to the documentation provided with each of them.
  - ◆ Set the power outlet configuration for each of the affected ports to *Kill the Power*.

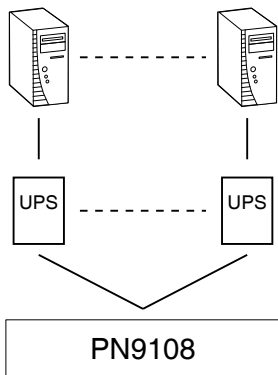

## Schedule

Clicking the Device Control *Schedule* button brings up the Scheduling dialog box:

Date	Enable/Disable	Shutdown Time (HH:MM)	Restart Time (HH:MM)
MON	<input type="checkbox"/>	0 : 0	0 : 0
TUE	<input type="checkbox"/>	0 : 0	0 : 0
WED	<input type="checkbox"/>	0 : 0	0 : 0
THU	<input type="checkbox"/>	0 : 0	0 : 0
FRI	<input type="checkbox"/>	0 : 0	0 : 0
SAT	<input type="checkbox"/>	0 : 0	0 : 0
SUN	<input type="checkbox"/>	0 : 0	0 : 0

This dialog box allows you to set up a scheduled Power On/Off configuration for each of the outlets. To do so:

1. Select your outlet from the buttons in the upper panel.
2. Put a check in the Enable/Disable checkbox to enable scheduling for the desired day.
3. Key in the Shutdown and Restart times.
4. Click **Save**.
5. Repeat for additional outlets.

## User Management

Clicking the Device Control *User Manager* button brings up the User Management dialog box:

















User Management									
PN9108-Station1									
Name	Password	A	B	C	D	E	F	G	H
alfred	****	<input checked="" type="checkbox"/>	<input checked="" type="checkbox"/>	<input checked="" type="checkbox"/>	<input checked="" type="checkbox"/>	<input type="checkbox"/>	<input type="checkbox"/>	<input type="checkbox"/>	<input type="checkbox"/>
marty	****	<input type="checkbox"/>	<input type="checkbox"/>	<input type="checkbox"/>	<input type="checkbox"/>	<input checked="" type="checkbox"/>	<input checked="" type="checkbox"/>	<input checked="" type="checkbox"/>	<input checked="" type="checkbox"/>
alice	****	<input checked="" type="checkbox"/>	<input type="checkbox"/>	<input checked="" type="checkbox"/>	<input type="checkbox"/>	<input checked="" type="checkbox"/>	<input type="checkbox"/>	<input checked="" type="checkbox"/>	<input type="checkbox"/>
william	****	<input checked="" type="checkbox"/>	<input checked="" type="checkbox"/>	<input checked="" type="checkbox"/>	<input checked="" type="checkbox"/>	<input checked="" type="checkbox"/>	<input checked="" type="checkbox"/>	<input checked="" type="checkbox"/>	<input checked="" type="checkbox"/>
Save									

This dialog box allows the Administrator to set up Usernames and Passwords that operators must provide in order to log into the PN9108. The minimum number of characters for each field is 4; the maximum is 15.

The Administrator also uses this dialog box to set the outlets that a User can control. A check mark in the box under the Outlet allows a User to control that Outlet.

## Monitor

Clicking the Device Control *Monitor* button brings up the Device Monitor display:

Device Monitor										
ID	Name	Current Load	Outlet Status							
			A	B	C	D	E	F	G	H
01	PN9108-Station1	0.10 A								
02	CP0108RPSwitch	N/A								

This display shows the power status of your entire installation.

You can see at a glance what the total current load for each of the Stations on the installation is, as well as the On/Off status of each outlet.

---

**Note:** If the *No timeout on monitoring* function is enabled in the *General Settings* dialog box (see page 19), the PN9108 will not time out when this function is being used.

---

## Log

Clicking the Device Control *Log* button brings up the Event Log dialog box:

The image shows a dialog box titled "Event Log" for "Station: PN9108 - No.4". It has three radio buttons: "Today", "All", and "Selected". Below the radio buttons are two date input fields: "From : ( YYYY/MM/DD )" and "To : ( YYYY/MM/DD )", both containing the date "2004/10/14". At the bottom is an "OK" button.

The PN9108 maintains a log file of the last 2048 events that took place on it. This dialog box allows you to select the range of events you wish to view:

- ◆ Choose **Today** then click **OK** to see a listing of only today's events.
- ◆ Choose **All** then click **OK** to see a listing of events for the entire log file.
- ◆ Choose **Selected**; key in the desired range of dates in the *From* and *To* fields; then click **OK** to see a listing of events for a specific time period.

Once you make a choice and click OK an Event Log List, similar to the one below, appears:

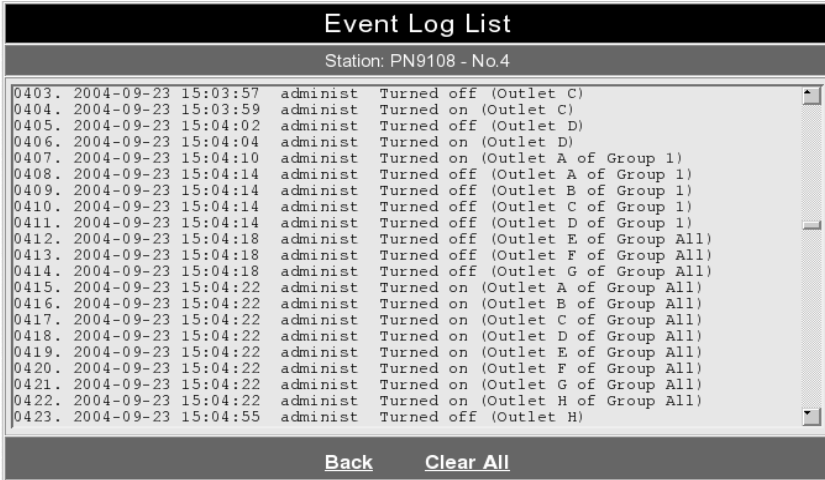

When you have finished viewing the event list:

- ◆ If you want to return to the Event Log dialog box, click **Back**.
- ◆ If you want to erase the contents of the entire log file, click **Clear All**.
- ◆ To exit, select a different Device Control function.



# Chapter 5

## Safe Shutdown and Reboot

### Overview

---

The PN9108's *Safe Shutdown and Reboot* functions are available for systems running Windows. Safe shutdown and reboot lets you safely close a system down and reboot it without involving the danger to the file systems that simply killing the power supply does. In order to use this function:

- ◆ You must connect a Safe Shutdown Cable from the PN9108 to the computer (see *Single Stage Installation*, page 10).
- ◆ You must enable either *Modem Ring Resume* or *System after AC back* (or both) in the computer BIOS' Power Management settings. If the BIOS has settings for the two of them, we recommend enabling them both.

### BIOS Power Management Settings

When making BIOS Power Management settings, please note the following:

1. The settings you select in the BIOS must match the settings you made in the Outlet *Configuration* dialog box (see *Configuration*, page 29).
2. If you choose *Modem Ring Resume*:
  - a) Your system BIOS must support this function;
  - b) Check your computer manual to be sure the system supports the COM port External Modem Wakeup function, since some BIOS versions only support this function with an internal PCI card modem.
  - c) If your BIOS doesn't support the COM port External Modem Wakeup function, you may wish to install an internal PCI card modem in order to use this function.
3. The wording for the *Modem Ring Resume* function may vary somewhat from system to system. For example:
  - ◆ Wake On LAN / Ring Connector
  - ◆ Modem Ring On
  - ◆ Power On By External Modem

In the BIOS settings, choose **Enabled**.

4. The wording for the *System after AC Back* function may vary somewhat from system to system. For example:
  - ◆ AC Loss Auto Restart
  - ◆ Restore on AC Power LossIn the BIOS settings, choose **Power On (Full On)**.
5. NT systems must use the *System after AC back* function.

## **Automated Setup**

---

There are two methods to set up safe shutdown and rebooting: Automated, and Manual. This section discusses an automated setup. Manual setup, is discussed on page 42. Automated setup is made possible with the use of the *Power Monitor* utility supplied on the software CD that came with this package.

---



**Note:** Power Monitor only works with Windows systems.

---

Power Monitor watches the computer's power status via the UPS signal. If the UPS signals a power failure and a low battery condition, a dialog box pops up to inform you that the utility will perform a safe shutdown in a few seconds.

## **Installation**

To install the Power Monitor, simply execute the self extracting setup program (PMonitorSetup.exe). A copy of PMonitor.exe is placed in the Windows Startup folder so that it executes each time the system is booted.

When monitoring is in effect, a monitoring icon in the form of lightning bolt (  ) is placed in the Windows taskbar to indicate so. When monitoring is temporarily disabled, a canceled lightning bolt icon (  ) is displayed.

- ◆ You can switch between enabled and disabled by right clicking the icon and selecting *Start Monitor* or *Stop Monitor* from the pop up context menu.
- ◆ You can exit the program by right clicking on the icon and selecting *Exit* from the pop up context menu.

By default, PMonitor monitors the COM1 port. If the utility displays an error message stating that it is unable to open the COM1 port, it means that the port is already being used by another utility.

You can either stop the other utility, and try again, or use a different COM port for the PMonitor program. If you choose to use a different COM port:

1. Stop the PMonitor program
2. Connect your safe shutdown cable to a different COM port
3. Right click on the *Monitoring Disabled* icon, and select *Options* from the context menu that appears. A dialog box, similar to the one below appears:

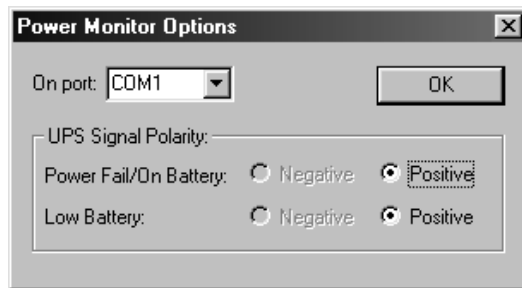

4. Open the list of COM ports, and select the COM port that the safe shutdown cable is connected to.

---

**Note:** Only changes to the COM port selection can be made in this dialog box. Since the utility only monitors the Positive UPS signals, the other settings are fixed.

---

## **Uninstalling**

To uninstall the utility:

1. Exit the Power Monitor program.
2. Open the Windows Start menu.
3. Choose Programs → Power Monitor → Uninstall Power Monitor.

## Manual Setup

---

Windows NT, 2000, XP, and Server 2003 can be manually configured for safe shutdown and rebooting instead of using the *Power Monitor* utility. The following sections explain the procedures involved.

### **Windows 2000 / XP / Server 2003:**

To set up Windows 2000, XP, or Server 2003 for safe shutdown and rebooting, do the following:

1. Go to the Control Panel; open *Power Options*; open the *UPS* page; in the Details panel, click **Select**. A dialog box similar to the one below appears:

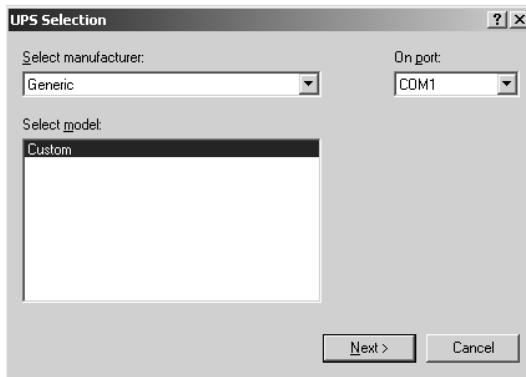

- a) For the COM port entry, select the COM port on the computer that the Safe Shutdown Cable is plugged into.
- b) Match the other options to the values shown in the figure above.

- Click **Next**. A dialog box similar to the one below appears:

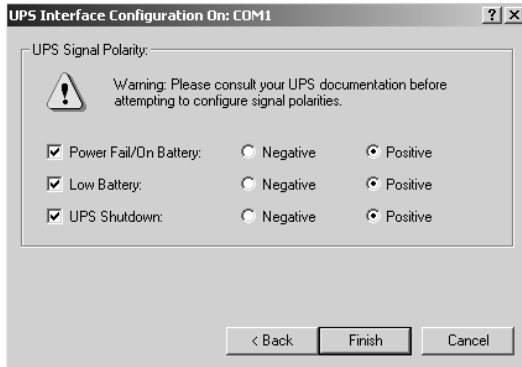

Select the options in the dialog box so that they match the settings shown in the figure above.

- Click **Finish**; click **OK**.

To check that the setup is working:

- Navigate through the following folders: Control Panel → Administrative Tools → Services.
- In Services, scroll down until you see the *Uninterruptible Power Supply* entry with *Started* for its status, as shown in the figure below:

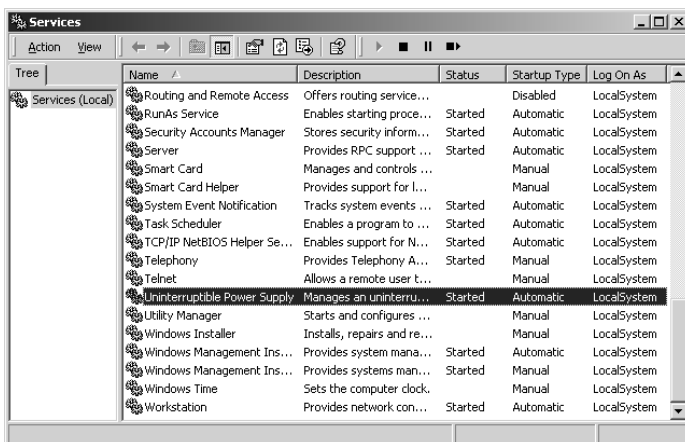

**NT:**

1. Go to the Control Panel; open the *UPS* entry. A dialog box similar to the one below appears:

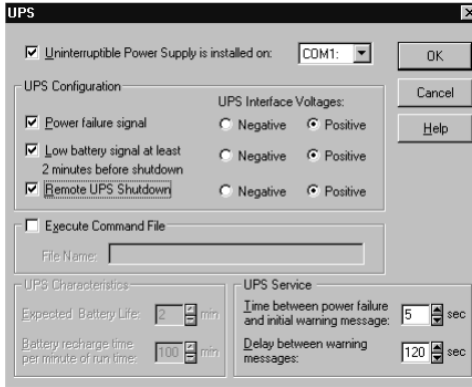

a) For the COM port entry, select the COM port on the computer that the Safe Shutdown Cable is plugged into.

b) Match the other options to the values shown in the figure above.

2. Click **OK** to finish

To check that the setup is working:

1. Navigate through the following folders: Control Panel → Administrative Tools → Services.
2. In Services, scroll down until you see the *Uninterruptible Power Supply* entry with *Started* for its status, as shown in the figure below:

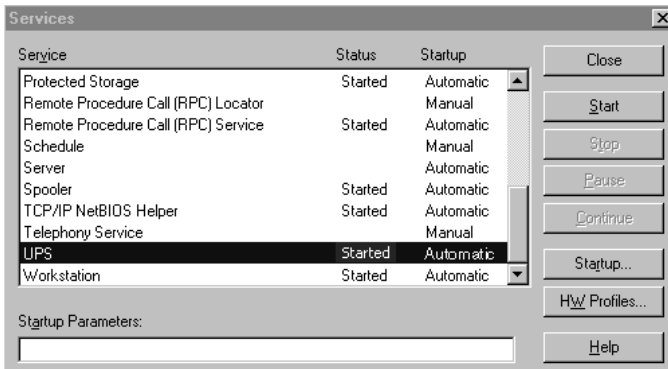

# Chapter 6

## Out of Band Operation

In case the LAN that the PN9108 resides on goes down, or the PN9108 cannot be accessed with the usual browser based method for some other reason, the PN9108 can be accessed via several *Out of Band* methods utilizing the PN9108's RS-232 port in the following ways:

- ◆ Connect the RS-232 port to the COM port of a local computer to operate the PN9108 Station from a local computer's console terminal (HyperTerminal, GTKTerminal, etc.).
- ◆ Connect the RS-232 port to a modem. Then, either dial in for console terminal operation, or use an ISP internet connection to access the PN9108 Station for browser operation.

This guide describes the various Out of Band access methods and how to implement them.

### OOB Configuration

---

To configure the PN9108 for OOB (Out Of Band) operation, click the OOB icon at the top of the web page.



The following dialog box appears:

### Out of Band Configuration

Out of Band Enable

---

**COM Port Connection Type**

Computer  Modem

---

**COM Port Settings**

Baudrate:

Enable OOB operation by clicking to put a checkmark in the *Out Of Band Enable* checkbox.

---

**Note:** Since OOB operation and UPS operation both require the use of the RS-232 port, enabling OOB automatically disables the PN9108's UPS feature.

---

The dialog box offers two COM Port Connection types: Computer and Modem.

### **Computer Connection**

This selection is for a direct connection between a local computer's COM port and the PN9108's RS-232 port.

1. For the *COM Port Settings*, select the baud rate that the two COM ports will use (usually 115200).
2. Click **Save** to set the baudrate selection that you made.

---

**Note:** Clicking **Restore** returns the baud rate entry to its previous setting.

---

3. Use a null modem cable to connect the local computer's serial port to the PN9108's RS-232 port.

---

**Note:** The null modem cable must be wired for either *full* or *loop back* handshaking. See the diagrams on page 90 for details.

---

You can now make a direct terminal or PPP connection to the PN9108. The procedure for making a direct terminal connection is discussed on page 50; the procedure for making a direct PPP connection is discussed on page 57.



## Modem Connection

The modem connection function makes it possible to access the PN9108 from a remote location with a dial in terminal connection; a dial in PPP connection; or a dial out connection.

For the dial out function, you must establish an account with an ISP (Internet Service Provider), and then use a modem to dial up to your ISP account. To configure the PN9108 for a dial up connection, do the following:

1. Select *Modem* in the OOB dialog box.

A new dialog box appears:

**Out of Band Configuration**

Out of Band Enable

---

**COM Port Connection Type**

Computer  Modem

---

**COM Port Settings**

Baudrate: 115200

---

Enable dial out

**Modem Settings**

Modem Type: Generic Modem

Initialization String:

---

**ISP Settings**

Phone Number:

Username:

Password:

---

**Dial Out Schedule**

Every: Never

Daily at:

PPP online time: 30 minute(s)

---

**Emergency dial out**

PPP keeps online until network recovery

PPP online time: 30 minute(s)

---

**Mail Configuration**

SMTP Server:

SMTP server requires authentication

Account Name:

Password:

Email From:

Dynamic IP from ISP

Email To:

Save Restore Disconnect

2. Make sure that the OOB function is enabled (there is a checkmark in the *Out Of Band Enable* checkbox).
3. Under *COM Port Settings*, specify the baud rate that your modem uses to connect to your ISP.

4. If you want the PN9108 to be able to dial out, activate the dial out function by putting a checkmark in the *Enable dial out* checkbox.

---

**Note:** Unless this function is enabled, you will only be able to dial in. None of the *Dial Out Schedule* functions (described below) will occur.

---

5. Under *Modem Settings*, specify your modem's configuration:
  - ◆ If your modem isn't in the *Modem Type* listbox, specify *Generic Modem* for the type.
  - ◆ Specify your modem's initialization string in the *Initialization String* field. Consult your modem's User Manual, if necessary.
6. Under *ISP Settings*, specify the telephone number, Username, and Password that you use to connect to your ISP.
7. Under *Dial out Schedule*, set up the times you want the PN9108 to be available over the ISP connection.
  - ◆ *Every* provides a listing of fixed times from every hour to every four hours.

---

**Note:** 1. If you don't want the PN9108 to dial out on a fixed schedule, select *Never* from the list.

2. If you select *Every two hours* (for example), the PN9108 will start dialling out every two hours beginning at the next complete hour (if it is now 13:10, it will start at 14:00).

---

- ◆ *Dial at* lets you specify variable times. Use the hh:mm format separated by a semicolon (there is no space before or after the semicolon). For example:

09:18;11:24;15:30

The PN9108 will dial out every day at the time(s) you specify.

- ◆ PPP online time specifies how long you want the ISP connection to last before terminating the session and hanging up the modem.

8. If the network goes down, or the PN9108 gets disconnected from it, the *Emergency dial out* function puts the PN9108 on line via the ISP dial up connection.
  - ◆ If you choose *PPP keeps online until network recovery*, the PPP connection to the ISP will last until the network comes back up or the PN9108 reconnects to it.
  - ◆ If you choose *PPP online time* the connection to the ISP will terminate after the amount of time you specify is up.
9. The *Mail Configuration* settings are used to send an email notifying you of the IP address that was dynamically assigned to the PN9108 by the ISP when a dial out occurs.
  - ◆ Key in the name or IP address of the ISP's SMTP mail server in the *SMTP Server:* field.
  - ◆ If your server requires authentication, check the *SMTP server requires authentication* checkbox and key in your account name and password in the fields provided.
  - ◆ Key in the email addresses of your ISP email account in the *Email from:* field.
  - ◆ Key in the email addresses of the users you want to receive the IP address in the *Email to:* field.

---

**Note:** A maximum of 128 characters can be entered in this box. To save space, user addresses can be comma, semicolon, or spacebar delimited.

---

### **Dialog Box Buttons**

- ◆ To save the values you have entered, click **Save**.
- ◆ To abandon your changes and restore your settings to their previous values, Click **Restore**.
- ◆ The *Disconnect* button is only active when an OOB modem connection operation is in progress. Clicking it breaks the connection.

---

## Direct Terminal Connection (HyperTerminal)

---

### HyperTerminal Setup

1. Use a 9 pin null modem cable (pin 2 to pin3; pin 3 to pin2) to connect a COM port on a PC to the PN9108's RS-232 port.

---

**Note:** The null modem cable must be wired for either *full* or *loop back* handshaking. See the diagrams on page 90for details.

---

2. On your PC, run the HyperTerminal program:

Start → Programs → Accessories → Communications → Hyper Terminal → Hypertrm.exe

The following dialog box appears:

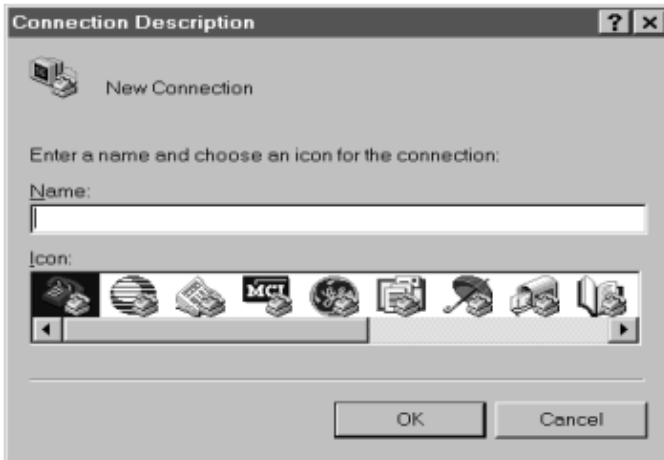

Key a name to describe the connection in the *Name* field (we used Com1Test); select an icon to represent the connection; then click **OK**.

---

**Note:** In the examples that follow we use COM1. If you use a different COM port, change the settings accordingly.

---

The following dialog box comes up:

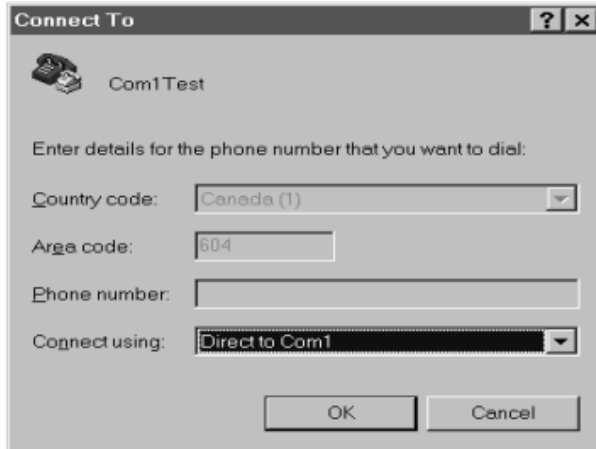

3. For the *Connect using:* field, select *Direct to COM1* (assuming you are using COM1 on your computer), then click **OK**. A *Port Setting* dialog box similar to the one below comes up:

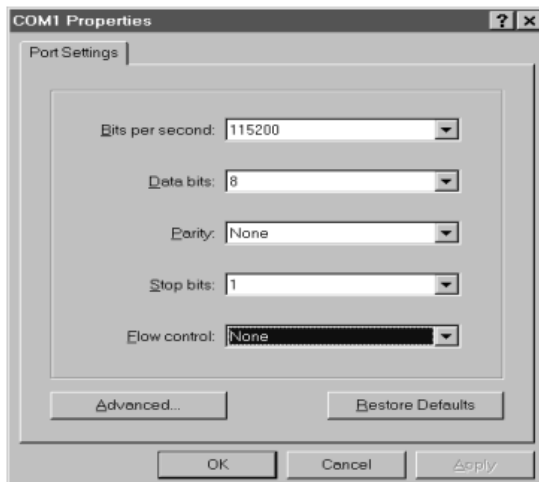

- For OOB connections, the PN9108's serial port settings and the computer's COM port settings must be the same. Change the settings in your dialog box (if necessary), so that they match the PN9108's COM Port settings (see *Modem Connection*, page 47, for details), then click **OK**.

---

**Note:** The PN9108's default settings are 115200 bps; 8 Data bits; No Parity; 1 Stop bit, but you can change the baud rate to something more suitable to your installation as long as they both match.

---

- When the HyperTerminal screen appears, open the File menu and select: Properties → Settings. The following dialog box displays:

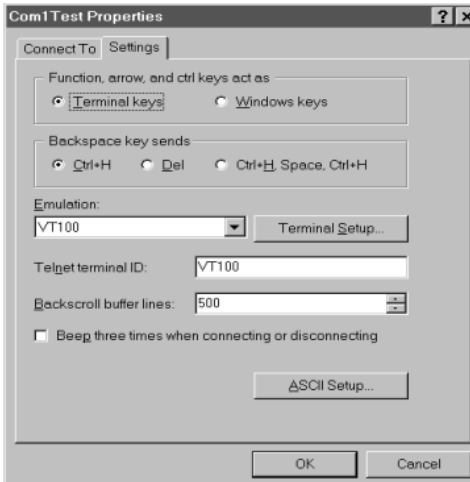

6. Change the settings (if necessary), so that they match the settings shown in the diagram, then click **ASCII Setup...** The ASCII Setup dialog box comes up:

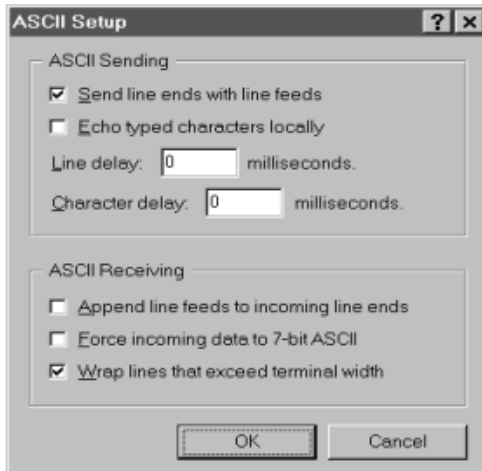

7. Change the settings (if necessary), so that they match the settings shown in the diagram, then click **OK**.
8. Close the HyperTerminal Window. When Windows asks if you want to disconnect, click **Yes**. When Windows asks if you want to save the session, click **Yes**.

This completes the HyperTerminal setup. For Windows NT, 2000, XP and Windows Server 2003 systems, a HyperTerminal icon that connects you to the PN9108 is created on the desktop. For Windows 98 and ME, you must access HyperTerminal from the Windows Start Menu.

## Logging In

1. Double click the HyperTerminal icon on your desktop.
2. In the VT100 terminal window, key in:  
???  
A login prompt appears.
3. Key in your Username and Password to bring up the PN9108's main menu.

---

## Indirect Terminal Connection (HyperTerminal)

---

### Connection Setup

1. Set up your hardware configuration to match the diagram, below:

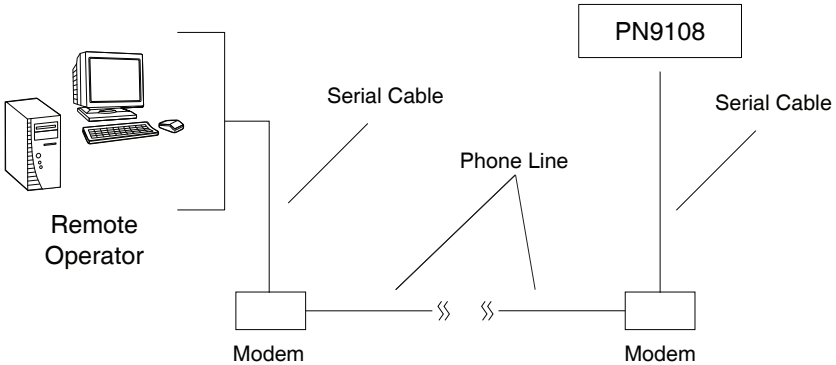

- 
- Note:**
1. Use standard 9 pin serial modem cables to connect to the modems.
  2. Connect the serial port of the modem that the PN9108 uses to its RS-232 port.
- 

2. Create a HyperTerminal connection.
  - a) Start with Step 2 of the HyperTerminal Setup section (page 50).
  - b) For *Connect Using:* in Step 3, either key in the full path to your modem driver, or select *Standard 28800bps Modem* from the list.
  - c) Follow Steps 4-8 to complete the setup and create the connection icon.

This completes the HyperTerminal setup. For Windows NT, 2000, XP and Windows Server 2003 systems, a HyperTerminal icon that connects you to the PN9108 is created on the desktop. For Windows 98 and ME, you must access HyperTerminal from the Windows Start Menu.



## Final Check

To make sure that the modem and COM port are correctly installed:

1. Open the Control Panel:

My Computer → Control Panel

2. Open the *Make New Connection* folder.

If all went well, you should see an entry with the name you assigned for this connection.

3. Open the Device Manager:

My Computer → Control Panel → System → Device Manager

Your *Modem* and *Ports* entries should look similar to the diagram below.

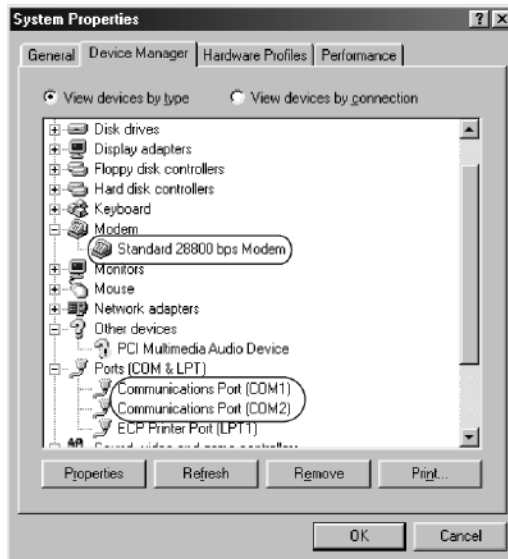

## **Logging In**

1. In the *Out of Band Configuration* dialog box (see page 47), make sure that the *Enable dial-out function* setting is disabled (the box is unchecked), and that the PN9108's baud rate is set to 115200.
2. Double click the HyperTerminal icon on your desktop.
3. In the VT100 terminal window, key in:

```
atdt [telephone number of the modem connected to the  
PN9108] [Enter]
```

The terminal responds with:

```
CONNECT115200
```

4. Wait at least 60 seconds, then key in:  
???
5. Key in your Username and Password to bring up the PN9108's main menu.

---

## Direct Dial In Connection (PPP)

---

This type of connection works directly through the COM port.

### Connection Setup

1. Use a 9 pin null modem cable to connect a COM port on a PC to the PN9108's RS-232 port.

---

**Note:** The null modem cable must be wired for either *full* or *loop back* handshaking. See the diagrams on page 90 for details.

---

2. On your PC, run the *Make New Connection* setup program:

Start → Programs → Accessories → Communications →  
Make New Connection

The following dialog box appears:

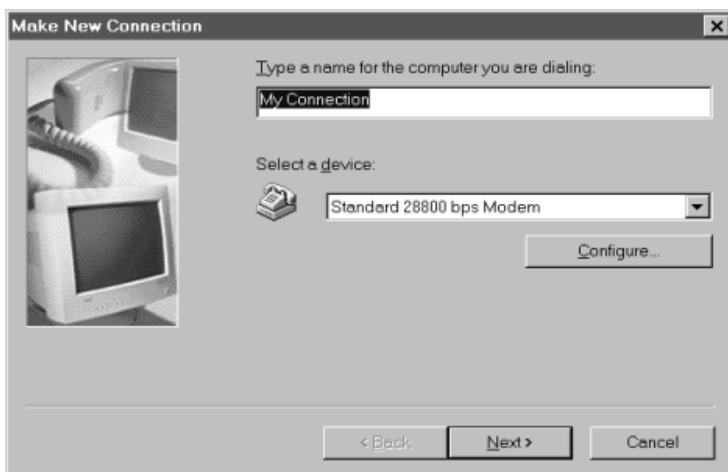

---

**Note:** In the examples that follow we use COM1. If you use a different COM port, change the settings accordingly.

---

3. Key a name of your choice in the top text box; select *Standard 28800 bps Modem* for the device; then click **Configure**. The *Modem Properties* dialog box comes up:

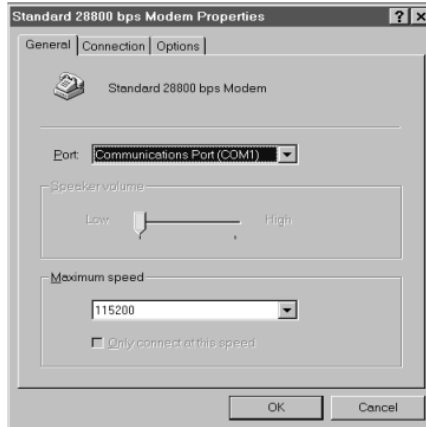

Change your settings (if necessary), so that they match the settings shown in the figure above (assuming you are using COM1 - if not choose a port setting that matches the COM port you are using).

---

**Note:** If you change the baud rate (speed), you must turn your modem Off and On for the change to take effect.

---

4. Click the **Connection** tab to see the connection setup page:

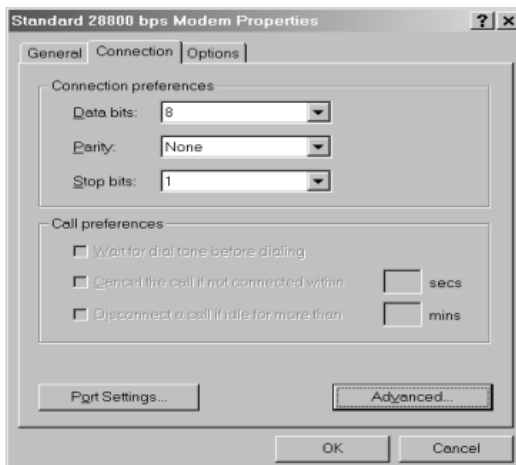

5. Change your settings (if necessary), so that they match the settings shown in the figure above; then click **Advanced**. The *Advanced Connection Settings* dialog box appears:

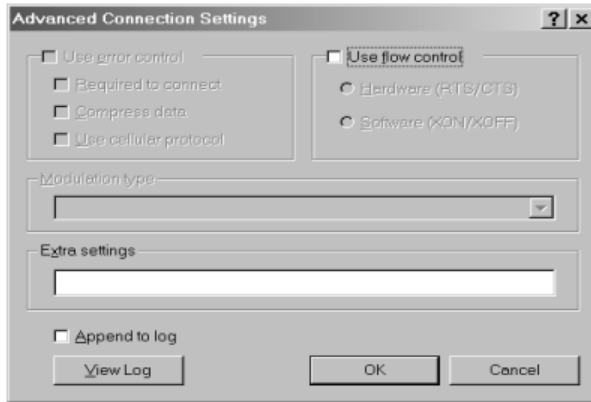

6. If there is a check mark in the *Use flow control* checkbox, uncheck it, then click **OK**.
7. Click **OK**; then click **Next**. The following dialog box appears:



8. Key in anything you like for the telephone number fields, then click **Next**.
9. Click **Finish**.

A new icon that you can use to connect to the PN9108 is created in the *Dial-up Network* folder.

## Finishing Up

1. Right click on the icon you just created, and select *Properties*. In the dialog box that appears, select the *Server Types* tab:

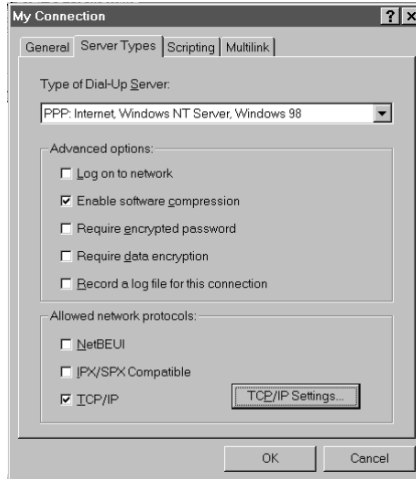

2. Match the checkboxes in the dialog box to the ones in the diagram, then click **TCP/IP Settings**. A dialog box similar to the one below appears:

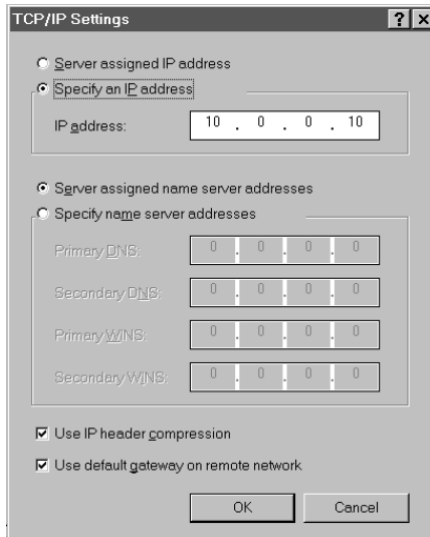

3. Change the dialog box settings to match the ones in the diagram.

---

**Note:** The IP address can be any address in the same network segment as the PN9108 (but not the same IP address as the PN9108).

---

4. Click **OK** to leave the dialog box, then click **OK** again.
5. In the *Out of Band Configuration* dialog box (see page 47), uncheck *Enable dial out*.

This completes the Direct Dial In setup.

## **Logging In**

1. Double click the icon you created in the *Dial-up Network* folder.
2. Key in your Username and Password, then click **Connect**.
3. Use your browser or Telnet to access the PN9108 the same way as if you were accessing it over the net.

## **Indirect Dial In Connection (PPP)**

---

This method uses a modem connection to phone into the PN9108 from a remote location.

### **Connection Setup**

1. Set up your hardware configuration to match the diagram, below:

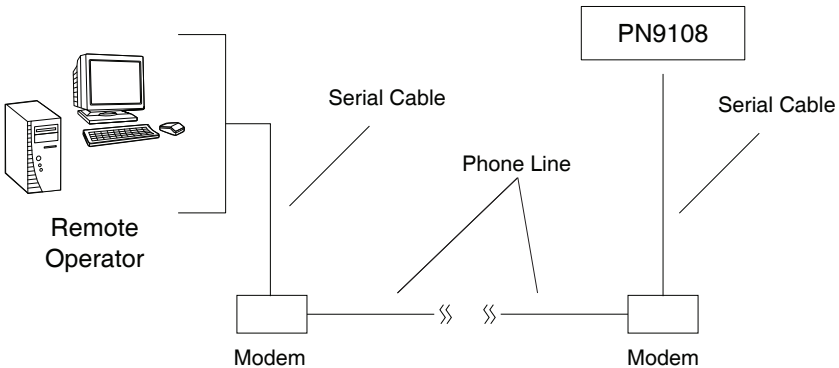

- 
- Note:**
1. Use standard 9 pin serial modem cables to connect to the modems.
  2. Connect the serial port of the modem that the PN9108 uses to its RS-232 port.
  3. The modem must be set to *Auto Answer* incoming calls.
- 

2. Set up your connection configuration as specified in Steps 2 - 9 of the *Direct Dial In Connection*, section (see page 57).
3. For Step 8, key in the telephone number of the modem that the PN9108 uses.
4. Click **Finish**.

A new icon that you can use to connect to the PN9108 is created in the *Dial-up Network* folder.



## **Finishing Up**

This step is the same as for a direct dial in connection. See page 60 for details.

## **Logging In**

1. In the *Out of Band Configuration* dialog box (see page 47), make sure that the *Enable dial-out function* setting is disabled (the box is unchecked), and that the PN9108's baud rate is set to 115200.
2. Double click the icon you created in the *Dial-up Network* folder.
3. Key in your Username and Password; click **Connect** and wait for the Authentication procedure to complete (be patient, it may take a few moments).
4. Use your browser or Telnet to access the PN9108 the same way as if you were accessing it over the net.

## Dial Out Connection

---

This configuration sets up a connection for the PN9108 to an ISP's site. You can use the dynamic IP address that the ISP assigns to the PN9108 to access it with a browser.

### Connection Setup

1. Set up your hardware configuration to match the diagram, below:

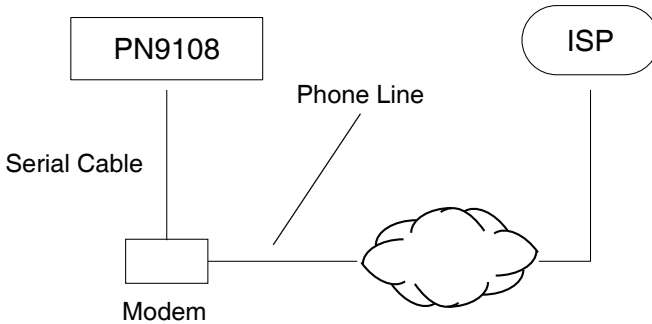

---

**Note:** Use a standard 9 pin serial modem cable to connect the modem to the PN9108's RS-232 port.

---

2. In the *Out of Band Configuration* dialog box (see page 47):
  - a) Make sure that the *Enable dial-out function* setting is enabled (there is a check mark in the box).
  - b) Fill in the Com Port, ISP, and Modem settings with values appropriate for connecting to your ISP.

---

**Note:** 1. If your modem isn't in the drop down list, select *Generic Modem* as the modem type.

2. If you choose *Generic Modem*, you must specify any necessary initialization commands in the *Initialization String* textbox. The commands should be separated by a semicolon (;). If you leave the initialization string blank, the PN9108 will only issue the **atdt** command.

---

- c) If you choose, you can set up a dial out schedule that puts the PN9108 on line over the internet via the ISP account by filling in the *Dial-out Schedule* information. See p. 48 for Dial-out Schedule details.
- d) Use the Mail Configuration section of the dialog box to have the PN9108's IP address (as assigned by the ISP) emailed to the people you want to access it.

### **Logging In**

Users can reach the log in page by specifying the PN9108's ISP assigned IP address in the URL address field of their browser.

## **Telnet**

### **Terminal Access**

1. On your computer, open a terminal (command line) session.
2. At the prompt, key in the following:

```
telnet [PN9108's IP Address]
```

---

**Note:** The IP address is assigned by your ISP.

---

3. Press **Enter**
4. At the login prompt, provide your Username and Password.

---

**Note:** If you cannot see the login prompt click *Terminal/Preferences* on the telnet session's menu bar, then select *VT-100/ANSI*.

---

Once a Telnet connection to the device is established, the PN9108's Main Menu comes up.

### **Browser Access**

1. In your browser's URL location bar, key in the following:

```
telnet://[PN9108's IP Address]
```

---

**Note:** The IP address is assigned by your ISP.

---

2. Press **Enter**
3. At the login prompt, provide your Username and Password.

## Chapter 7

# Upgrading The Firmware

The Firmware Upgrade Utility provides a smooth, automated process for upgrading the PN9108's firmware. New firmware upgrade packages are posted on our web site as they become available. Check the site regularly to find the latest packages.

### **Preparation**

---

1. From your computer, go to our Internet support site and choose the model name that relates to your device (PN9108) to get a list of available Firmware Upgrade Packages.
2. Choose the Firmware Upgrade Package you want to install (usually the most recent), and download it to your computer.

## Starting the Upgrade

---

To start the upgrade, do the following:

1. From the computer that you downloaded the upgrade file to, log into the PN9108.
2. Click the *Firmware* icon. The Firmware Upgrade dialog box appears:



The screenshot shows a dialog box titled "Firmware Upgrade". It has a black header bar with the title in white. Below the header, the text "Attach the upload file" is displayed. Underneath is a text input field with a "Browse..." button to its right. Below the input field is a checked checkbox labeled "Check Firmware Version". At the bottom of the dialog box is an "Upload" button.

3. Click the *Browse* button; navigate to the upgrade file, and select it.
4. Click **Upload** to perform the upgrade.

- 
- Note:**
1. On a daisy chained installation, the upgrade procedure starts with the second station. The remaining stations are automatically upgraded in turn, with the first station upgraded last. After all of the stations have been upgraded, they all restart automatically.
  2. If you enable *Check Firmware Version*, the upgrade function compares the device's firmware level with that of the upgrade files. If it finds that the PN9108's current version is equal to, higher than, the upgrade version, it won't overwrite the PN9108's version.
  3. If you do not enable *Check Firmware Version*, the Utility installs the upgrade files without checking whether they are a higher level, or not.
-

## Safety Instructions

---

### General

- ◆ This product is for indoor use only.
- ◆ Read all of these instructions. Save them for future reference.
- ◆ Follow all warnings and instructions marked on the device.
- ◆ Do not place the device on any unstable surface (cart, stand, table, etc.). If the device falls, serious damage will result.
- ◆ Do not use the device near water.
- ◆ Do not place the device near, or over, radiators or heat registers.
- ◆ The device cabinet is provided with slots and openings to allow for adequate ventilation. To ensure reliable operation, and to protect against overheating, these openings must never be blocked or covered.
- ◆ The device should never be placed on a soft surface (bed, sofa, rug, etc.) as this will block its ventilation openings. Likewise, the device should not be placed in a built in enclosure unless adequate ventilation has been provided.
- ◆ Never spill liquid of any kind on the device.
- ◆ Unplug the device from the wall outlet before cleaning. Do not use liquid or aerosol cleaners. Use a damp cloth for cleaning.
- ◆ The device should be operated from the type of power source indicated on the marking label. If you are not sure of the type of power available, consult your dealer or local power company.
- ◆ The device is designed for IT power distribution systems with 230V phase-to-phase voltage.
- ◆ To prevent damage to your installation it is important that all devices are properly grounded.
- ◆ The device is equipped with a 3-wire grounding type plug. This is a safety feature. If you are unable to insert the plug into the outlet, contact your electrician to replace your obsolete outlet. Do not attempt to defeat the purpose of the grounding-type plug. Always follow your local/national wiring codes.
- ◆ Do not allow anything to rest on the power cord or cables. Route the power cord and cables so that they cannot be stepped on or tripped over.

- ◆ If an extension cord is used with this device make sure that the total of the ampere ratings of all products used on this cord does not exceed the extension cord ampere rating. Make sure that the total of all products plugged into the wall outlet does not exceed 15 amperes.
- ◆ To help protect your system from sudden, transient increases and decreases in electrical power, use a surge suppressor, line conditioner, or uninterruptible power supply (UPS).
- ◆ Position system cables and power cables carefully; Be sure that nothing rests on any cables.
- ◆ When connecting or disconnecting power to hot pluggable power supplies, observe the following guidelines:
- ◆ Install the power supply before connecting the power cable to the power supply.
- ◆ Unplug the power cable before removing the power supply.
- ◆ If the system has multiple sources of power, disconnect power from the system by unplugging all power cables from the power supplies.
- ◆ Never push objects of any kind into or through cabinet slots. They may touch dangerous voltage points or short out parts resulting in a risk of fire or electrical shock.
- ◆ Do not attempt to service the device yourself. Refer all servicing to qualified service personnel.
- ◆ If the following conditions occur, unplug the device from the wall outlet and bring it to qualified service personnel for repair.
  - ◆ The power cord or plug has become damaged or frayed.
  - ◆ Liquid has been spilled into the device.
  - ◆ The device has been exposed to rain or water.
  - ◆ The device has been dropped, or the cabinet has been damaged.
  - ◆ The device exhibits a distinct change in performance, indicating a need for service.
  - ◆ The device does not operate normally when the operating instructions are followed.
- ◆ Only adjust those controls that are covered in the operating instructions. Improper adjustment of other controls may result in damage that will require extensive work by a qualified technician to repair.



---

## **Rack Mounting**

- ◆ Before working on the rack, make sure that the stabilizers are secured to the rack, extended to the floor, and that the full weight of the rack rests on the floor. Install front and side stabilizers on a single rack or front stabilizers for joined multiple racks before working on the rack.
- ◆ Always load the rack from the bottom up, and load the heaviest item in the rack first.
- ◆ Make sure that the rack is level and stable before extending a device from the rack.
- ◆ Use caution when pressing the device rail release latches and sliding a device into or out of a rack; the slide rails can pinch your fingers.
- ◆ After a device is inserted into the rack, carefully extend the rail into a locking position, and then slide the device into the rack.
- ◆ Do not overload the AC supply branch circuit that provides power to the rack. The total rack load should not exceed 80 percent of the branch circuit rating.
- ◆ Make sure that all equipment used on the rack – including power strips and other electrical connectors – is properly grounded.
- ◆ Ensure that proper airflow is provided to devices in the rack.
- ◆ Ensure that the operating ambient temperature of the rack environment does not exceed the maximum ambient temperature specified for the equipment by the manufacturer
- ◆ Do not step on or stand on any device when servicing other devices in a rack.

## Consignes de sécurité

---

### **Général**

- ♦ Ce produit est destiné exclusivement à une utilisation à l'intérieur.
- ♦ Veuillez lire la totalité de ces instructions. Conservez-les afin de pouvoir vous y référer ultérieurement.
- ♦ Respectez l'ensemble des avertissements et instructions inscrits sur l'appareil.
- ♦ Ne placez jamais l'unité sur une surface instable (chariot, pied, table, etc.). Si l'unité venait à tomber, elle serait gravement endommagée.
- ♦ N'utilisez pas l'unité à proximité de l'eau.
- ♦ Ne placez pas l'unité à proximité de ou sur des radiateurs ou bouches de chaleur.
- ♦ Le boîtier de l'unité est doté de fentes et d'ouvertures destinées à assurer une ventilation adéquate. Pour garantir un fonctionnement fiable et protéger l'unité contre les surchauffes, ces ouvertures ne doivent jamais être bloquées ou couvertes.
- ♦ L'unité ne doit jamais être placée sur une surface molle (lit, canapé, tapis, etc.) car ses ouvertures de ventilation se trouveraient bloquées. De même, l'unité ne doit pas être placée dans un meuble fermé à moins qu'une ventilation adaptée ne soit assurée.
- ♦ Ne renversez jamais de liquides de quelque sorte que ce soit sur l'unité.
- ♦ Débranchez l'unité de la prise murale avant de la nettoyer. N'utilisez pas de produits de nettoyage liquide ou sous forme d'aérosol. Utilisez un chiffon humide pour le nettoyage de l'unité.
- ♦ L'appareil doit être alimenté par le type de source indiqué sur l'étiquette. Si vous n'êtes pas sûr du type d'alimentation disponible, consultez votre revendeur ou le fournisseur local d'électricité.
- ♦ Afin de ne pas endommager votre installation, vérifiez que tous les périphériques sont correctement mis à la terre.
- ♦ L'unité est équipée d'une fiche de terre à trois fils. Il s'agit d'une fonction de sécurité. Si vous ne parvenez pas à insérer la fiche dans la prise murale, contactez votre électricité afin qu'il remplace cette dernière qui doit être obsolète. N'essayez pas d'aller à l'encontre de l'objectif de la fiche de terre. Respectez toujours les codes de câblage en vigueur dans votre région/pays.

- 
- ◆ L'équipement doit être installé à proximité de la prise murale et le dispositif de déconnexion (prise de courant femelle) doit être facile d'accès.
  - ◆ La prise murale doit être installée à proximité de l'équipement et doit être facile d'accès.
  - ◆ Veillez à ce que rien ne repose sur le cordon d'alimentation ou les câbles. Acheminez le cordon d'alimentation et les câbles de sorte que personne ne puisse marcher ou trébucher dessus.
  - ◆ En cas d'utilisation d'une rallonge avec cette unité, assurez-vous que le total des ampérages de tous les produits utilisés sur cette rallonge ne dépasse pas l'ampérage nominal de cette dernière. Assurez-vous que le total des ampérages de tous les produits branchés sur la prise murale ne dépasse pas 15 ampères.
  - ◆ Pour contribuer à protéger votre système contre les augmentations et diminutions soudaines et transitoires de puissance électrique, utilisez un parasurtenseur, un filtre de ligne ou un système d'alimentation sans coupure (UPS).
  - ◆ Placez les câbles du système et les câbles d'alimentation avec précaution ; veillez à ce que rien ne repose sur aucun des câbles.
  - ◆ Lors du branchement ou du débranchement à des blocs d'alimentation permettant la connexion à chaud, veuillez respecter les lignes directrices suivantes:
    - ◆ Installez le bloc d'alimentation avant de brancher le câble d'alimentation à celui-ci.
    - ◆ Débranchez le câble d'alimentation avant de retirer le bloc d'alimentation.
    - ◆ Si le système présente plusieurs sources d'alimentation, déconnectez le système de l'alimentation en débranchant tous les câbles d'alimentation des blocs d'alimentation.
    - ◆ N'insérez jamais d'objets de quelque sorte que ce soit dans ou à travers les fentes du boîtier. Ils pourraient entrer en contact avec des points de tension dangereuse ou court-circuiter des pièces, entraînant ainsi un risque d'incendie ou de choc électrique.
    - ◆ N'essayez pas de réparer l'unité vous-même. Confiez toute opération de réparation à du personnel qualifié.
  - ◆ Si les conditions suivantes se produisent, débranchez l'unité de la prise murale et amenez-la à un technicien qualifié pour la faire réparer:
    - ◆ Le cordon d'alimentation ou la fiche ont été endommagés ou éraillés.
    - ◆ Du liquide a été renversé dans l'unité.
-

- ◆ L'unité a été exposée à la pluie ou à l'eau.
- ◆ L'unité est tombée ou le boîtier a été endommagé.
- ◆ Les performances de l'unité sont visiblement altérées, ce qui indique la nécessité d'une réparation.
- ◆ L'unité ne fonctionne pas normalement bien que les instructions d'utilisation soient respectées.
- ◆ N'utilisez que les commandes qui sont abordées dans le mode d'emploi. Le réglage incorrect d'autres commandes peut être à l'origine de dommages qui nécessiteront beaucoup de travail pour qu'un technicien qualifié puisse réparer l'unité.
- ◆ Ne connectez pas le connecteur RJ-11 portant la marque « Sensor » (Capteur) à un réseau de télécommunication public.

---

## **Montage sur bâti**

- ◆ Avant de travailler sur le bâti, assurez-vous que les stabilisateurs sont bien fixés sur le bâti, qu'ils sont étendus au sol et que tout le poids du bâti repose sur le sol. Installez les stabilisateurs avant et latéraux sur un même bâti ou bien les stabilisateurs avant si plusieurs bâtis sont réunis, avant de travailler sur le bâti.
- ◆ Chargez toujours le bâti de bas en haut et chargez l'élément le plus lourd en premier.
- ◆ Assurez-vous que le bâti est à niveau et qu'il est stable avant de sortir une unité du bâti.
- ◆ Agissez avec précaution lorsque vous appuyez sur les loquets de libération du rail d'unité et lorsque vous faites coulisser une unité dans et hors d'un bâti ; vous pourriez vous pincer les doigts dans les rails.
- ◆ Une fois qu'une unité a été insérée dans le bâti, étendez avec précaution le rail dans une position de verrouillage puis faites glisser l'unité dans le bâti.
- ◆ Ne surchargez pas le circuit de l'alimentation CA qui alimente le bâti. La charge totale du bâti ne doit pas dépasser 80 % de la capacité du circuit.
- ◆ Assurez-vous que tous les équipements utilisés sur le bâti, y-compris les multiprises et autres connecteurs électriques, sont correctement mis à la terre.
- ◆ Assurez-vous que les unités présentes dans le bâti bénéficie d'une circulation d'air suffisante.
- ◆ Assurez-vous que la température ambiante de fonctionnement de l'environnement du bâti ne dépasse pas la température ambiante maximale spécifiée pour l'équipement par le fabricant.
- ◆ Ne marchez sur aucun appareil lors de la maintenance d'autres appareils d'un bâti.

## **Power Cords**

Use the cables supplied with this package. If it becomes necessary to replace the cables supplied with this package, be sure to use cables of at least the same standard as the ones provided.

### **Power Cord:**

For models with a 220 - 240 V AC power supply, use a tandem (T blade) type attachment plug with ground connector power cord that meets the respective European country's safety regulations, such as VDE for Germany. The plug should comply with the VDE 0620 specification; the connector should comply with the VDE 0625 specification. A minimum 10 A, 0.75 mm<sup>2</sup> x 3G power cord (H05VV-F or VW-1) should be used.

### **Power Outlet Cords:**

For models with a 220 - 240 V AC power supply, the connector should comply with the VDE 0625 or EN60320 specification. A minimum 10 A, 0.75 mm<sup>2</sup> x 3G power cord (H05VV-F or VW-1) should be used.

## Technical Support

---

### International

- ◆ For online technical support – including troubleshooting, documentation, and software updates: **<http://support.aten.com>**
- ◆ For telephone support, see *Telephone Support*, page iii

### North America

Email Support		<a href="mailto:support@aten-usa.com">support@aten-usa.com</a>
Online Technical Support	Troubleshooting Documentation Software Updates	<a href="http://www.aten-usa.com/support">http://www.aten-usa.com/support</a>
Telephone Support		1-888-999-ATEN ext 4988

When you contact us, please have the following information ready beforehand:

- ◆ Product model number, serial number, and date of purchase.
- ◆ Your computer configuration, including operating system, revision level, expansion cards, and software.
- ◆ Any error messages displayed at the time the error occurred.
- ◆ The sequence of operations that led up to the error.
- ◆ Any other information you feel may be of help.

---

## IP Address Determination

---

The PN9108's default setting is to obtain its IP address automatically from a DHCP server. When the PN9108 starts, it waits to get an address from a DHCP server. If, after one minute, it fails to obtain an address from the DHCP server, it reverts to its default IP address of 192.168.0.60.

If you are an administrator and need to determine the PN9108's IP address, or want to assign it one, there are three methods to choose from. In each case, your computer must be on the same network segment as the PN9108.

### Method 1:

For computers running Windows, an IP address can be determined and/or assigned with the IP Installer utility:

1. Open the IPInstaller directory on the Software CD that came with your PN9108 package and run IPInstaller.exe. A dialog box similar to the one below appears:

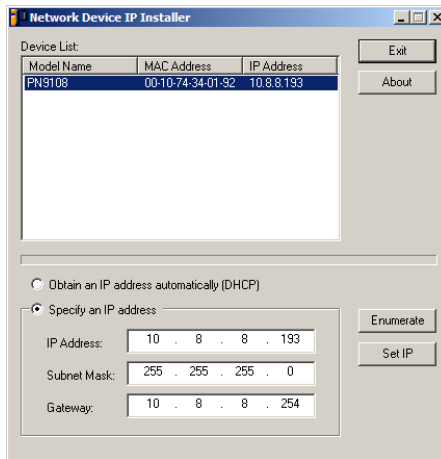

2. Select the PN9108 in the *Device List*.

---

**Note:** 1. If the list is empty, or your device doesn't appear, click **Enumerate** to refresh the Device List.

2. If there is more than one device in the list, use the MAC address to pick the one you want. The PN9108's MAC address is located on its bottom panel.
-



3. Select either *Obtain an IP address automatically (DHCP)*, or *Specify an IP address*. If you chose the latter, fill the IP Address, Subnet Mask, and Gateway fields with the information appropriate to your network.
4. Click **Set IP**.
5. After the IP address shows up in the Device List, click **Exit** to end the program.

### Method 2:

1. Set your computer's IP address to 192.168.0.XXX  
Where XXX represents any number or numbers except 60. (192.168.0.60) is the default address of the PN9108.)
2. Specify the switch's default IP address (192.168.0.60) in your browser, and you will be able to connect.
3. Assign a fixed IP address for the PN9108 (on the Network page), then click **Save and Restart** (at the bottom of the page).
4. Reset your computer's IP address to its original value.

### Method 3:

A fixed IP address can also be assigned with the ARP command as follows:

1. Turn off the power to the PN9108.
2. Enter the following command:

```
arp -s <ip address> <PN9108's MAC address>
```

Where the IP address that you assign is one suitable for the network segment that the PN9108 resides on.

---

**Note:** The PN9108's MAC address can be found on its bottom panel.

---

3. Turn the power to the PN9108 back on.
4. In your browser, go to the IP address you just assigned and log in with your Username and Password.

---

**Note:** You must log in within 30 seconds after entering the arp command. Therefore, it would be advisable to have your browser all set up to go to the IP address beforehand.

---

5. Once you have logged in, go to Network Settings to set up the permanent IP environment (see page 21).

## Trusted Certificates

---

### Overview

When you try to log in to the device from your browser, a Security Alert message appears to inform you that the device's certificate is not trusted, and asks if you want to proceed.

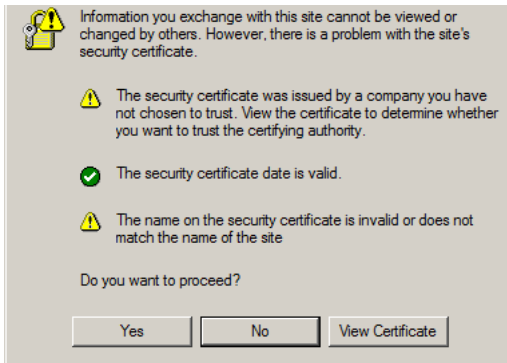

The certificate can be trusted, but the alert is triggered because the certificate's name is not found on Microsoft list of Trusted Authorities. You have two options: 1) you can ignore the warning and click **Yes** to go on; or 2) you can install the certificate and have it be recognized as trusted.

- ◆ If you are working on a computer at another location, accept the certificate for just this session by clicking **Yes**.
- ◆ If you are working at your own computer, install the certificate on your computer (see below for details). After the certificate is installed, it will be recognized as trusted.

---

**Note:** The security alert message will appear even after installing the certificate, but now the icon related to the first paragraph will be a check mark (indicating no alert) instead of the exclamation mark icon.

---

## Installing the Certificate

To install the certificate, do the following:

1. In the *Security Alert* dialog box, click **View Certificate**. The *Certificate Information* dialog box appears:

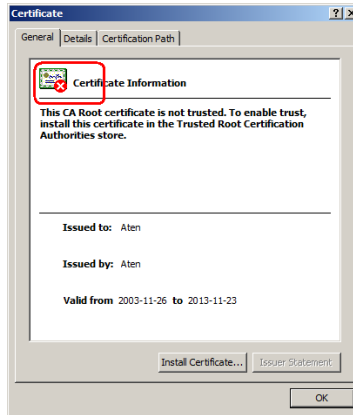

**Note:** There is a red and white X logo over the certificate to indicate that it is not trusted.

2. Click **Install Certificate**.
3. Follow the Installation Wizard to complete the installation. Unless you have a specific reason to choose otherwise, accept the default options.
4. When the Wizard presents a caution screen:

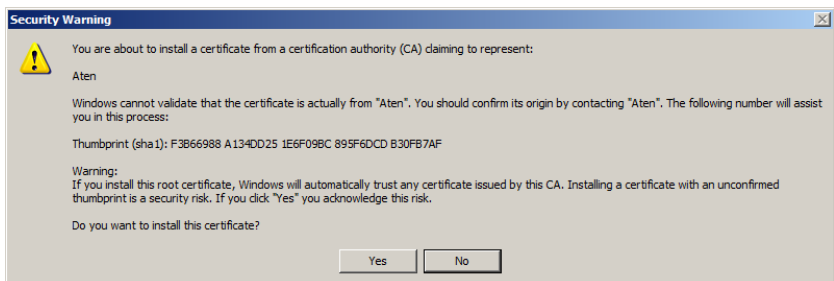

Click **Yes**.

- Next, click **Finish** to complete the installation; then click **OK** to close the dialog box.

## **Certificate Trusted**

The certificate is now trusted:

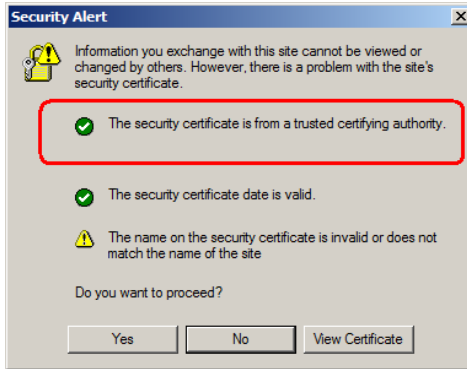

When you click *View Certificate*, you can see that the red and white X logo is no longer present – further indication that the certificate is trusted:

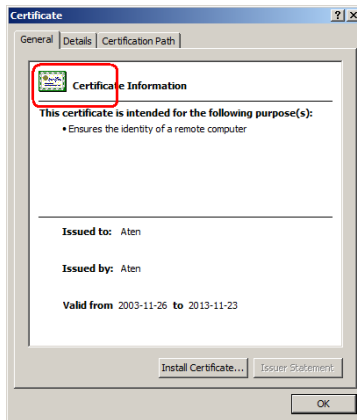

---

## Self-Signed Private Certificates

---

If you wish to create your own self-signed encryption key and certificate, a free utility – `openssl.exe` – is available for download over the web at [www.openssl.org](http://www.openssl.org). To create your private key and certificate do the following:

1. Go to the directory where you downloaded and extracted `openssl.exe` to.
2. Run `openssl.exe` with the following parameters:

```
openssl req -new -newkey rsa:1024 -days 3653 -nodes -x509
-keyout CA.key -out CA.cer -config openssl.cnf
```

---

**Note:** 1. The command should be entered all on one line (i.e., do not press [Enter] until all the parameters have been keyed in).

2. If there are spaces in the input, surround the entry in quotes (e.g., “ATEN International”).
- 

To avoid having to input information during key generation the following additional parameters can be used:

```
/C /ST /L /O /OU /CN /emailAddress.
```

### Examples

```
openssl req -new -newkey rsa:1024 -days 3653 -nodes -x509
-keyout CA.key -out CA.cer -config openssl.cnf -subj
/C=yourcountry/ST=yourstateorprovince/L=yourlocationor
city/O=yourorganization/OU=yourorganizationalunit/
CN=yourcommonname/emailAddress=name@yourcompany.com
```

```
openssl req -new -newkey rsa:1024 -days 3653 -nodes -x509
-keyout CA.key -out CA.cer -config openssl.cnf -subj
/C=CA/ST=BC/L=Richmond/O="ATEN International"/OU=ATEN
/CN=ATEN/emailAddress=eservice@aten.com.tw
```

### Importing the Files

After the `openssl.exe` program completes, two files – `CA.key` (the private key) and `CA.cer` (the self-signed SSL certificate) – are created in the directory that you ran the program from. These are the files that you upload in the *Private Certificate* panel of the Security page (see page 27).

## Troubleshooting

---

### Overview

Operation problems can be due to a variety of causes. The first step in solving them is to make sure that all cables are securely attached and seated completely in their sockets.

In addition, updating the product's firmware may solve problems that have been discovered and resolved since the prior version was released. If your product is not running the latest firmware version, we strongly recommend that you upgrade. See Chapter 7, *Upgrading The Firmware*, for upgrade details.

### Problem 1:

On a safe shutdown and reboot operation, when rebooting, the computer stops at the logon screen and waits for a Username and Password instead of automatically logging on.

### Solution:

The *Autologon* function hasn't been configured. Set it up as follows:

1. For Win NT, run *regedit.exe*; for Win 2000 or XP, run *regedt32*
2. Select the following:  
HKEY\_LOCAL\_MACHINE\SOFTWARE\Microsoft\Windows NT\Current Version\Winlogon
3. Under the *Edit* menu, select **Add Value**.
4. Add the variables and values as shown in the table below:

Name	Value
DefaultDomainName	[domain name for this computer]
DefaultUserName	[user name for this computer]
DefaultPassword	[user password for this computer]
AutoAdminLogon	1

---

**Note:** Remove the brackets and replace the text inside the brackets with suitable values for yourself on this computer.

---

5. Close the Registry Editor.

---

**Note:** Make sure you have a real password (not blank) configured for logging on to your system.

---

**Problem 2:**

The computer has an older mainboard that doesn't support APM in the BIOS. What can I do to get Safe Shutdown and Reboot working?

**Solution:**

If you are running Windows 2000, XP, or Server 2003, you can do the following:

1. Open Control Panel → Power Options.
2. Open Properties → APM.
3. Enable Advanced Power Management support.

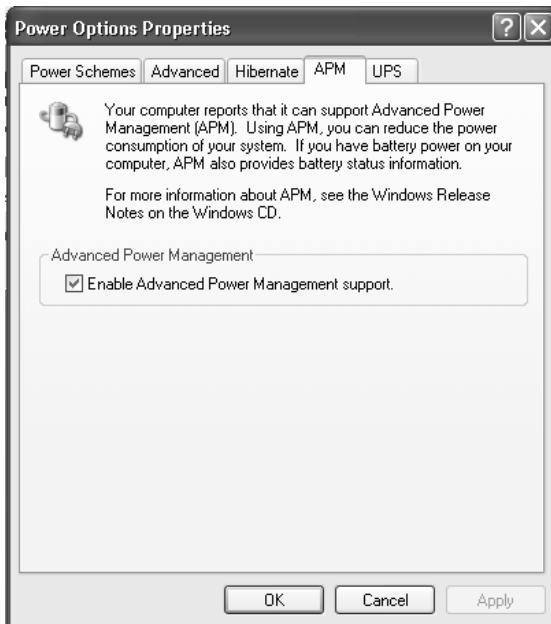

**Problem 3:**

I have enabled *Synchronize with NTP Server* in the Date / Time dialog box, but I am unable to obtain the date and time from an NTP server on the internet.

**Solution:**

Contact your MIS department and have them enable a port for the NTP server.

**Problem 4:**

Although my computers have been configured for a Safe Shutdown, some of them don't shut down.

**Solution:**

This may be due to the applications running on them putting up a dialog box asking if you want to save the information running on them before they close. Since you haven't provided an answer, the shutdown procedure doesn't continue to completion.

You can either change their shutdown behavior to *Kill the Power* - which is not a Safe Shutdown option, or use a product such as *KVM over the NET™* to access them remotely and answer the dialog box questions.

**Problem 5:**

When I log in, the browser generates a *CA Root certificate is not trusted*, or a *Certificate Error* response.

**Solution:**

The certificate's name is not found on Microsoft's list of Trusted Authorities. The certificate can be trusted, however. See *Trusted Certificates*, page 80, for details.

**Problem 6:**

Although I have enabled *Modem Ring Resume*, the computers won't restart.

**Solution:**

1. Make sure you have enabled *Modem Ring Resume* in the computer's BIOS settings.
2. If *Modem Ring Resume* has been enabled in the computer's BIOS, check your mainboard manual to make sure it supports *external* modem wakeup. See *BIOS Power Management Settings*, page 39, for further details.



3. *Modem Ring Resume* supports restarting after a normal power down. If the computer shut down due to a crash or a power failure, you must restart the computer in order for *Modem Ring Resume* to function again.

A workaround for this is to enable *System after AC Back* (see *System after AC Back\**, page 30).

We recommend enabling both *Modem Ring Resume* and *System after AC Back* – assuming your computer’s BIOS supports it.

**Problem 7:**

*System after AC Back* doesn’t work.

**Solution:**

Make sure *System after AC Back* is set to **On** (not *Last State*) in your computer’s BIOS.

**Problem 8:**

After I rack mount my PN9108, the cables often come unplugged from the back of the unit.

**Solution:**

The connectors used on this device all conform to industry standard specifications. Nevertheless, if this problem occurs, we recommend using cable ties and cable bars to safely and securely route the cables. Contact your rack dealer for the cable routing hardware appropriate for your rack.

## Administrator Login Failure

---

If you are unable to perform an Administrator login (because the Username and Password information has become corrupted, or you have forgotten it, for example), you can clear the login information with the following procedure:

1. Power off the PN9108 and remove its housing.
2. Short the jumper labeled J6.

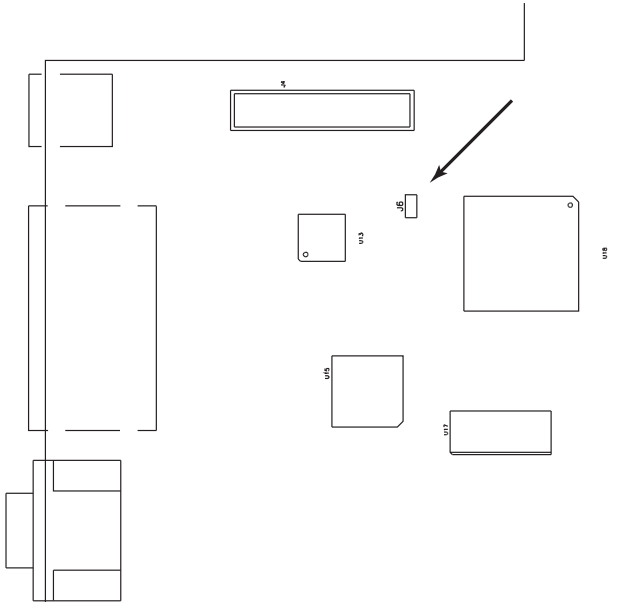

3. Power on the switch.
4. When the Link and 10/100Mbps LEDs flash, power off the switch.
5. Remove the jumper cap from J6.
6. Close the housing and start the PN9108 back up.

After you start back up, you can use the default Username and Password (see page 13) to log in.

# Specifications

Function		PN9108A	PN9108G
Power Characteristics		100–240 VAC; 15A*	100–240 VAC; 10A**
Power Inlet		1 x IEC 60320/C14 (M)	
Power Outlets		8 x IEC 60320/C13 (F)	
I/P Rating (Total input - max)		100–120 V AC; 50/60Hz; 12A	220–240 V AC; 50/60Hz; 10A
O/P Rating	Per Port (max)	100–120 V AC; 50/60Hz; 9A	220–240 V AC; 50/60Hz; 9A
	Total (max)	100–120 V AC; 50/60Hz; 11A	220–240 V AC; 50/60Hz; 9A
LEDs	Outlet Power	8 (orange)	
	Remote Access	8 (green)	
	Link	1 (green)	
	10/100 Mbps	1 (orange/green)	
	Power	1 (blue)	
	Current	1 (red)	
	Station ID	2 x 7 segment (yellow)	
Connectors	PON In	1 x DB-9 (F)	
	PON Out	1 x DB-9 (M)	
	LAN	1 x RJ-45	
	RS-232	1 x DB-9 (M)	
	Safe Shutdown	8 x 6-pin Safe Shutdown Jacks (F)	
Switches	Power	1 x Rocker	
	Outlet On / Off Remote On / Off	8 x Pushbutton	
	Sta. ID Display	1 x Pushbutton	
	Reset	1 x Semi hidden	
Power Consumption (no load)		120V; 60Hz; 16W	230V; 50Hz; 16W
Power Consumption (max. load)		120V; 60Hz; 1440W	230V; 50Hz; 2300W
Environment		Operating Temperature: 0 ~ 40°C	
		Storage Temperature: -20 ~ 60°C	
		Humidity: 0 ~ 80% RH Noncondensing	
Housing		Metal	
Weight		4.2 kg	
Dimensions (L x W x H)		43.20 x 25.40 x 4.40 cm	

\* Units are certified to 80% of max. current rating (100—120 VAC).

\*\* Units are certified to 220—240 VAC.

## Null Modem Cable Diagrams

Null modem with loop back handshaking

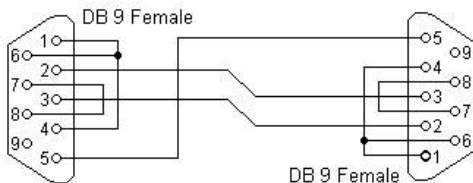

Null modem with full handshaking

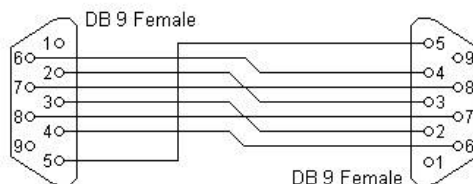

## Battery Replacement

This equipment is provided with a replaceable lithium battery: CR2032 3V. Replacement by an incorrect type may result in an explosion.

**CAUTION!**

**RISK OF EXPLOSION IF BATTERY IS REPLACED BY AN INCORRECT TYPE.**

**DISPOSE OF USED BATTERIES ACCORDING TO THE INSTRUCTIONS.**

---

## Limited Warranty

---

ATEN warrants this product against defects in material or workmanship for a period of one (1) year from the date of purchase. If this product proves to be defective, contact ATEN's support department for repair or replacement of your unit. ATEN will not issue a refund. Return requests can not be processed without the original proof of purchase.

When returning the product, you must ship the product in its original packaging or packaging that gives an equal degree of protection. Include your proof of purchase in the packaging and the RMA number clearly marked on the outside of the package.

This warranty becomes invalid if the factory-supplied serial number has been removed or altered on the product.

This warranty does not cover cosmetic damage or damage due to acts of God, accident, misuse, abuse, negligence or modification of any part of the product. This warranty does not cover damage due to improper operation or maintenance, connection to improper equipment, or attempted repair by anyone other than ATEN. This warranty does not cover products sold AS IS or WITH FAULTS.

IN NO EVENT SHALL ATEN'S LIABILITY EXCEED THE PRICE PAID FOR THE PRODUCT. FURTHER, ATEN SHALL NOT BE RESPONSIBLE FOR DIRECT, INDIRECT, SPECIAL, INCIDENTAL OR CONSEQUENTIAL DAMAGES RESULTING FROM THE USE OF THE PRODUCT, ITS ACCOMPANYING SOFTWARE, OR ITS DOCUMENTATION. ATEN SHALL NOT IN ANY WAY BE RESPONSIBLE FOR, WITHOUT LIMITATION, LOSS OF DATA, LOSS OF PROFITS, DOWNTIME, GOODWILL, DAMAGE OR REPLACEMENT OF EQUIPMENT OR PROPERTY, AND ANY EXPENSES FROM RECOVERY, PROGRAMMING, AND REPRODUCTION OF ANY PROGRAM OR DATA.

ATEN makes no warranty or representation, expressed, implied, or statutory with respect to its products, contents or use of this documentation and all accompanying software, and specifically disclaims its quality, performance, merchantability, or fitness for any particular purpose.

ATEN reserves the right to revise or update its product, software or documentation without obligation to notify any individual or entity of such revisions, or update.

For details about extended warranties, please contact one of our dedicated value added resellers.

This Page Intentionally Left Blank

# Index

## A

- Administration, 19
  - Date and time, 25
  - Device control
    - config., 29
  - General settings, 19
  - Log, 37
  - Logout, 28
  - Maintenance, 26
  - Monitor, 36
  - Network settings, 21
  - Power management config, 29
  - Schedule, 34
  - User Management, 35
- Administrator, 20
- Administrator Login Failure, 88

## B

- Battery Replacement, 90
- BIOS
  - Power Management, 39
- Browser operation, 13

## C

- Components, 4
- Configuration
  - power management, 29
  - working environment, 19
- Connection Control, 20
- Corrupt Password, 88

## D

- Daisy Chaining, 12
- Date and time, 25
- Device control, 15
  - configuration, 29

- power status, 16

- Device Control Monitor, 36
- Dial out connection, 64
- Direct dial in connection, 57
- Direct terminal connection, 50

## F

- Features, 2
- Firmware Upgrade, 26, 67
- Firmware upgrade, 67
- Forgotten Password, 88

## G

- General Settings, 19
- General settings, 19

## H

- HyperTerminal, 50

## I

- Indirect dial in connection, 62
- Indirect terminal connection, 54
- Installation
  - Daisy Chaining, 12
  - Single stage, 10
- IP address determination, 78

## L

- LEDs
  - Port, 4
- Log, 37
- Logging in, 13
- Logout, 28

## M

- Main Screen, 14
- Maintenance, 26

Modem Ring Resume, 4, 30, 39, 86, 87

Monitor, 36

Mounting, 8

## N

Network settings, 21

Null Modem Cable Diagrams, 90

## O

Online

Registration, iii

OOB

Computer Connection, 46

Configuration, 45

Dialog Box Buttons, 49

Modem Connection, 47

OOB Operation

Dial out connection, 64

Direct dial in, 57

Direct terminal, 50

Indirect dial in, 62

Indirect terminal connection, 54

Operation, 13

Out Of Band Operation, 45

Outlet configuration, 29

Outlet Groups, 32

Overview, 1

## P

Port

LEDs, 4

Power management config., 29

Power Management Settings, 39

Power status screen

Bottom panel, 18

Top panel, 16

Private Certificates, 83

## R

Rack Mounting, 8

Requirements, 3

## S

Safe Shutdown

Automated Setup, 40

Manual Setup, 42

Safe Shutdown and Reboot, 39

Safety Instructions

General, 69

Rack Mounting, 71

Schedule, 34

Self-signed certificates, 83

Session timeout, 20

Single stage installation, 10

SJ/T 11364-2006, ii

Specifications, 89

Stacking, 7

System after AC Back, 30, 40, 87

System Information, 20

## T

Technical Support, 77

Telephone support, iii

Telnet, 66

Timeout, 20

Troubleshooting, 84

Trusted Certificates, 80

## U

UPS, 32

User Management, 35

User Notice, iii

## W

Working environment configuration, 19