



Simply Better Connections

OL1000LV / OL1500LV /  
OL2000LV / OL3000LV

Professional Online UPS (UL Listed)  
User Manual

## Compliance Statements

---

### FEDERAL COMMUNICATIONS COMMISSION INTERFERENCE STATEMENT

This equipment has been tested and found to comply with the limits for a Class A digital device, pursuant to Part 15 of the FCC Rules. These limits are designed to provide reasonable protection against harmful interference when the equipment is operated in a commercial environment. This equipment generates, uses, and can radiate radio frequency energy and, if not installed and used in accordance with the instruction manual, may cause harmful interference to radio communications. Operation of this equipment in a residential area is likely to cause harmful interference in which case the user will be required to correct the interference at his own expense.

The device complies with Part 15 of the FCC Rules. Operation is subject to the following two conditions: (1) this device may not cause harmful interference, and (2) this device must accept any interference received, including interference that may cause undesired operation.

#### FCC Caution

Any changes or modifications not expressly approved by the party responsible for compliance could void the user's authority to operate this equipment.

#### Warning

Operation of this equipment in a residential environment could cause radio interference.

#### Achtung

Der Gebrauch dieses Geräts in Wohnumgebung kann Funkstörungen verursachen.



#### KCC Statement

유선 제품용 / A 급 기기 (업무용 방송 통신 기기)  
이 기기는 업무용 (A 급) 전자파적합기기로서 판매자 또는 사용자는 이  
점을 주의하시기 바라며, 가정 외의 지역에서 사용하는 것을 목적으로  
합니다.

**Industry Canada Statement**

This Class A digital apparatus complies with Canadian ICES-003.

**CAN ICES-003 (A) / NMB-003 (A)**

UL Listed

**RoHS**

This product is RoHS compliant.

**User Information****Online Registration**

Be sure to register your product at our online support center:

|               |   |
|---------------|---|
| International | <a href="http://eservice.aten.com">http://eservice.aten.com</a> |
|---------------|---|

**Telephone Support**

For telephone support, call this number:

|               |   |
|---------------|---|
| International | 886-2-8692-6959                           |
| China         | 86-400-810-0-810                          |
| Japan         | 81-3-5615-5811                            |
| Korea         | 82-2-467-6789                             |
| North America | 1-888-999-ATEN ext 4988<br>1-949-428-1111 |

**User Notice**

All information, documentation, and specifications contained in this manual are subject to change without prior notification by the manufacturer. The manufacturer makes no representations or warranties, either expressed or

implied, with respect to the contents hereof and specifically disclaims any warranties as to merchantability or fitness for any particular purpose. Any of the manufacturer's software described in this manual is sold or licensed as is. Should the programs prove defective following their purchase, the buyer (and not the manufacturer, its distributor, or its dealer), assumes the entire cost of all necessary servicing, repair and any incidental or consequential damages resulting from any defect in the software.

The manufacturer of this system is not responsible for any radio and/or TV interference caused by unauthorized modifications to this device. It is the responsibility of the user to correct such interference.

The manufacturer is not responsible for any damage incurred in the operation of this system if the correct operational voltage setting was not selected prior to operation. PLEASE VERIFY THAT THE VOLTAGE SETTING IS CORRECT BEFORE USE.

## Product Information

---

For information about all ATEN products and how they can help you connect without limits, visit ATEN on the Web or contact an ATEN Authorized Reseller. Visit ATEN on the Web for a list of locations and telephone numbers:

|               |   |
|---------------|---|
| International | <a href="http://www.aten.com">http://www.aten.com</a>         |
| North America | <a href="http://www.aten-usa.com">http://www.aten-usa.com</a> |

## Battery Information

Please only install battery package from our authorized dealers. The battery package information is listed below:

### Internal Battery

| Rated      | Description                       | Model Name |
|------------|-----------------------------------|------------|
| 1000VA(2B) | 2 x 9AH, 2 pcs batteries in total | BC24V9AH   |
| 1000VA(3B) | 3 x 7AH, 3 pcs batteries in total | BC36V7AH   |
| 1500VA(3B) | 3 x 9AH, 3 pcs batteries in total | BC36V9AH   |
| 2000VA(4B) | 4 x 9AH, 4 pcs batteries in total | BC48V9AH   |
| 2000VA(6B) | 6 x 7AH, 6 pcs batteries in total | BC72V7AH   |
| 3000VA(6B) | 6 x 9AH, 6 pcs batteries in total | BC72V9AH   |

### External Battery Package

| Rated      | Description                           | Model Name |
|------------|---------------------------------------|------------|
| 1000VA(2B) | 2*2 x 9 AH, 4 pcs batteries in total  | BP24V18AH  |
| 1000VA(3B) | 2*3 x 9 AH, 6 pcs batteries in total  | BP36V18AH  |
| 1500VA(3B) | 2*3 x 9 AH, 6 pcs batteries in total  | BP36V18AH  |
| 2000VA(4B) | 2*4 x 9 AH, 8 pcs batteries in total  | BP48V18AH  |
| 2000VA(6B) | 2*6 x 9 AH, 12 pcs batteries in total | BP72V18AH  |
| 3000VA(6B) | 2*6 x 9 AH, 12 pcs batteries in total | BP72V18AH  |

## **Package Contents**

---

Check to make sure that all components are in working order. If you encounter any problem, please contact your dealer.

The UPS package consists of:

- ◆ 1 Online UPS
- ◆ 1 rack mount kit
- ◆ 1 rail slide kit
- ◆ 1 RS-232 cable
- ◆ 1 USB Type-A to Type-B cable
- ◆ 1 tower stand set (4 pcs)
- ◆ 1 user instructions

# Contents

---

|  |     |
|--|-----|
| Compliance Statements . . . . .          | ii  |
| User Information . . . . .               | iii |
| Online Registration . . . . .            | iii |
| Telephone Support . . . . .              | iii |
| User Notice . . . . .                    | iii |
| Product Information . . . . .            | iv  |
| Battery Information . . . . .            | v   |
| Internal Battery . . . . .               | v   |
| External Battery Package . . . . .       | v   |
| Package Contents . . . . .               | vi  |
| Contents . . . . .                       | vii |
| About this Manual . . . . .              | ix  |
| Conventions . . . . .                    | x   |
| <br>                                     |     |
| <b>1. Introduction</b>                   |     |
| Overview . . . . .                       | 1   |
| Features . . . . .                       | 3   |
| Operation Principle . . . . .            | 4   |
| Components . . . . .                     | 5   |
| Front View (All Models) . . . . .        | 5   |
| Rear View . . . . .                      | 6   |
| <br>                                     |     |
| <b>2. Hardware Setup</b>                 |     |
| Mounting . . . . .                       | 9   |
| Rack Mount . . . . .                     | 9   |
| Vertical (Tower) Desktop Mount . . . . . | 13  |
| Mounting UPS with Battery Box. . . . .   | 14  |
| Connecting Internal Battery . . . . .    | 18  |
| Installation . . . . .                   | 20  |
| External Battery Connection . . . . .    | 22  |
| <br>                                     |     |
| <b>3. General Operations</b>             |     |
| Turn On the UPS. . . . .                 | 25  |
| EPO Function . . . . .                   | 25  |
| Install Software . . . . .               | 25  |
| <br>                                     |     |
| <b>4. LCD/Button Operations</b>          |     |
| Overview . . . . .                       | 27  |
| Button Operation . . . . .               | 27  |
| LCD Panel . . . . .                      | 28  |
| Audible Alarm . . . . .                  | 30  |
| LCD Display Wordings Index . . . . .     | 31  |
| UPS Setting . . . . .                    | 33  |

|   |    |
|---|----|
| Suggested Battery Charger Current . . . . . | 40 |
| Operating Mode Description . . . . .        | 43 |
| Faults Reference Code . . . . .             | 44 |
| Warning Indicator . . . . .                 | 45 |

## **Appendix**

|   |    |
|---|----|
| Safety Instructions . . . . .             | 47 |
| Transportation . . . . .                  | 47 |
| Preparation . . . . .                     | 47 |
| Installation . . . . .                    | 47 |
| Operation . . . . .                       | 48 |
| Maintenance, service and faults . . . . . | 49 |
| Technical Support . . . . .               | 51 |
| International . . . . .                   | 51 |
| North America . . . . .                   | 51 |
| Specifications . . . . .                  | 52 |
| LV Series . . . . .                       | 52 |
| Troubleshooting . . . . .                 | 55 |
| Limited Warranty . . . . .                | 58 |



## About this Manual

---

This user manual is provided to help you get the most out of your ATEN professional UPS. It covers all aspects of the unit, including installation, configuration, and operation.

The models covered in this manual include:

| Model    |
|----------|
| OL1000LV |
| OL1500LV |
| OL2000LV |
| OL3000LV |

An overview of the information found in the manual is provided below.

**Chapter 1, Introduction,** introduces you to the Professional Online UPS. Its purpose, features and benefits are presented, and its front and back panel components are described.

**Chapter 2, Hardware Setup,** provides step-by-step instructions to setting up your unit, and explains the connections in detail.

**Chapter 3, General Operations,** explains the general operations of the unit.

**Chapter 4, LCD/Button Operations,** describes the LCD and its button operations in more details.

**Appendix,** at the end of the manual provides technical and troubleshooting information.

---

### Note:

- ◆ Read this manual thoroughly and follow the installation and operation procedures carefully to prevent any damage to the unit or connected devices.
- ◆ ATEN regularly updates its product documentation for new features and fixes. For an up-to-date ATEN RBS documentation, visit <http://www.aten.com/global/en/>

## **Conventions**

This manual uses the following conventions:

- |   |  |
|---|--|
| Monospaced  | Indicates text that you should key in.   |
| [ ]   | Indicates keys you should press. For example, [Enter] means to press the <b>Enter</b> key. If keys need to be chorded, they appear together in the same bracket with a plus sign between them: [Ctrl+Alt]. |
| 1.  | Numbered lists represent procedures with sequential steps.   |
| ◆   | Bullet lists provide information, but do not involve sequential steps.   |
| >   | Indicates consecutive selections (such as on a menu or dialog box). For example, Start > Run means to open the <i>Start</i> menu, and then select <i>Run</i> .   |
|  | Indicates critical information.  |

# Chapter 1

## Introduction

### Overview

---

ATEN Professional Online UPS is an advanced electrical apparatus that provides emergency power to a load when the input power source or the mains power fails. The basic technology of an online UPS is similar to that of a standby or line-interactive UPS, however, the ATEN Professional Online UPS provides a much greater current AC-to-DC battery-charger/rectifier where the rectifier and inverter are designed to run continuously with improved cooling systems.

Through years of working with computer hardware, the vast majority of hardware failures can be attributed directly to the amount of stress hardware components experience during shutdown and startup processes, especially if power surges or blackouts are involved. Additionally, having sustained changing weather conditions, the aging electrical grid may pose hazards hiding behind walls. Your equipment is under constant attack from power problems. Even a brief loss of power, sags or a momentary surge can ruin your equipment and destroy irreplaceable data.

Desktop computers don't have batteries built-in like laptops do. If you were working on a desktop computer and encountered with a power outage, the system would come to an immediate halt. Not only would you lose your work, but the process imposes unnecessary stress to your machine. By using an UPS, even when a power loss occurs, the batteries of the UPS keep the power steady and unchanged.

The ATEN Professional Online UPS adjusts incoming AC power, provides battery backup to pass through most outages and saves open files automatically. When power is restored, the UPS begins recharging its batteries.

The Online UPS unit continuously filters the wall power through the battery system. Since the attached electronics run completely off the battery (that are always topped off by the external power supply), there is never a single millisecond of power interruption when there are power losses or voltage regulation issues. The Online UPS unit acts as an effective electric firewall between your devices and the outside world by stabilizing all the electricity your devices are ever exposed to.

The UPS has one USB port and one serial port that allow connection and communication between the UPS and the connected computer. A power management software installed on the connected computer(s) gives IT professionals with the tools they need to easily monitor and manage their backup power. This advanced software allows users to access vital UPS battery conditions, load levels, and runtime information as well as provide graceful unattended shut down of network computers and virtual machines connected to a battery backup during a power event.

The ATEN Professional Online UPS offers a contemporary way to access to detailed UPS settings and information with LCD screen. The illuminated LCD screen can display the input voltage, battery capacity, etc. and includes a three-button configuration interface and audible alarms for various operation modes.

## Features

---

- ◆ True double-conversion — Output power factor is 1, which means all of the power supplied is being used for productive work and makes work the most efficient
- ◆ Output voltage regulation < 1% — Provides higher performance and efficiency for critical applications
- ◆ Programmable power management outlets — Users can easily and independently control load segments. During power failure, this feature enables users to extend battery time to mission-critical devices by shutting down the noncritical devices
- ◆ Emergency power off function (EPO) — EPO connector at rear panel allows emergency UPS Power Off from a remote location
- ◆ SNMP + USB + RS-232 multiple communications — Allows either USB or RS-232 communication port to work with SNMP interface simultaneously
- ◆ Hot swappable battery design — All potential UPS maintenance, including complete power module exchange, can be performed without powering down connected equipment. As long as utility power is on, you may leave the UPS and connected equipment on while replacing a new battery
- ◆ ECO mode for energy saving — Offers up to 97% efficiency to cut energy usage and cost. UPS power application via static bypass, timely returning to online double conversion when the need arises
- ◆ Provides over voltage cut-off protection and surge immunity by MOV for full time equipment protection
- ◆ High power factor charger up to 1000 W capacity with very low ripple current when charging battery
- ◆ Multi-functional LCD interface — Displays immediate, detailed information, including the input voltage, battery capacity, power status, battery status, operating status, assessed backup runtime, and etc.
- ◆ Smart battery charger design to optimize battery performance — Adjusts the charging voltage according to outside temperature and effectively extends the batteries' life spans.

## Operation Principle

---

The operation principle of the UPS is shown in the diagram below:

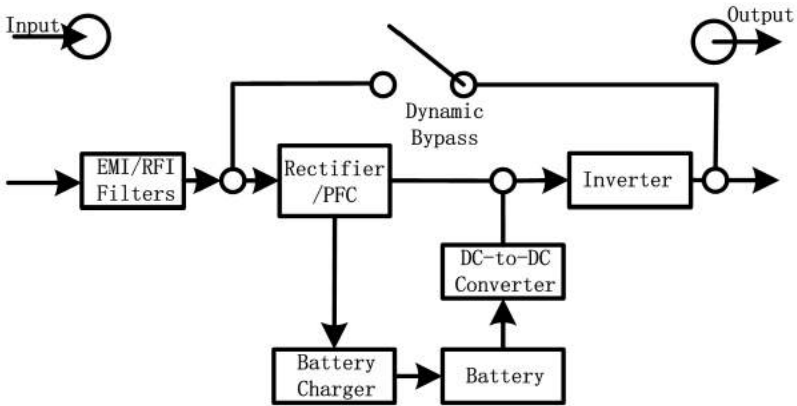

The UPS is composed of a mains input, EMI/RFI filters, a rectifier/PFC, inverter, a battery charger, a DC-to-DC converter, a battery package, a dynamic bypass and an UPS output.

## Components

### Front View (All Models)

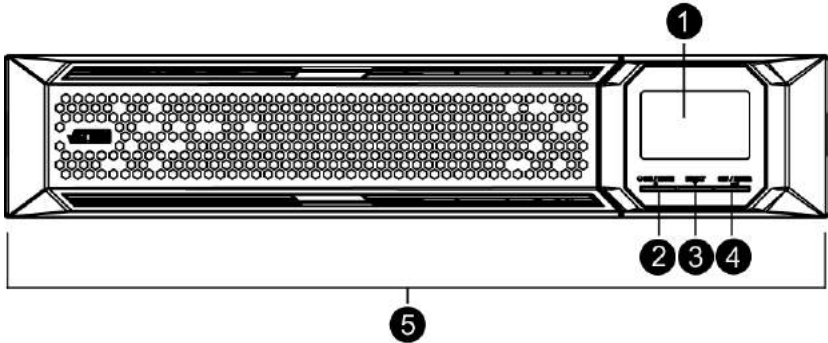

| No. | Component             | Description                              |
|-----|-----------------------|--|
| 1   | LCD display           |  |
| 2   | on / mute button      | Click this to turn on the LCD            |
| 3   | select button         | Click this to jump to the next selection |
| 4   | off / enter button    | Click this to turn off the LCD           |
| 5   | removable front panel |  |

## Rear View

1K / 1.5K (OL1000LV / OL1500LV)

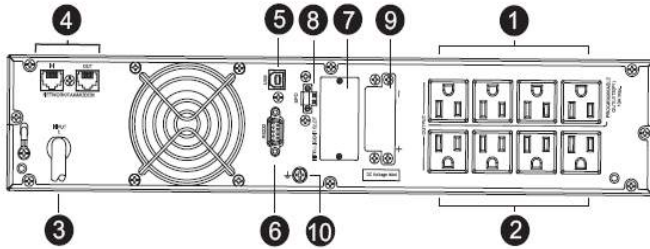

2K (OL2000LV)

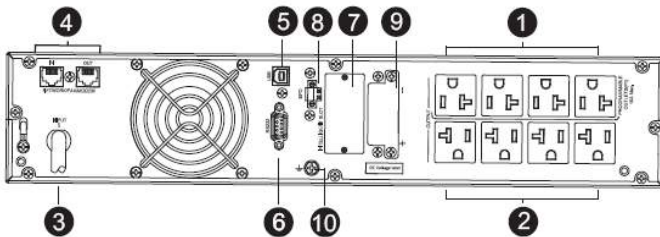

3K (OL3000LV)

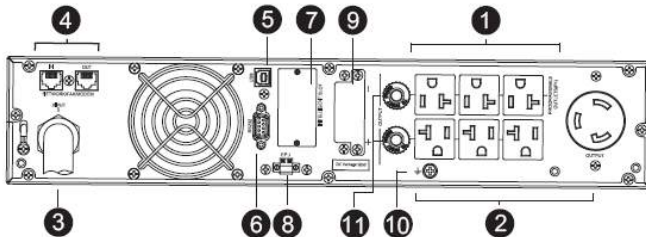

| No. | Component                          | Description   |
|-----|------------------------------------|---|
| 1   | programmable outlets               | For non-critical load connection. These outlets can be programmed to provide backup power and surge protection. |
| 2   | backup and surge protected outlets | For critical load connection. These outlets provide backup power and surge protection.                          |
| 3   | AC input                           | Connect the power cable to an AC power socket.  |



---

| No. | Component                                    | Description  |
|-----|--|--|
| 4   | network / fax / modem surge protection       | Protects standard RJ-45-based products (LAN lines) and cabling systems from surges.  |
| 5   | USB communication port                       | For scheduled UPS shutdown / startup and status monitoring.  |
| 6   | RS-232 communication port                    | For scheduled UPS shutdown / startup and status monitoring.  |
| 7   | SNMP intelligent slot                        | The UPS is equipped with an intelligent slot perfect for SNMP. When installing SNMP in the UPS, it will provide advanced communication and monitoring options.                   |
| 8   | emergency power off function connector (EPO) | Enables an emergency UPS power off from a remote location.   |
| 9   | external battery connection port             | This port connects to external battery pack for backup power. For external battery pack, please refer to <i>Battery Information</i> on page v.                                   |
| 10  | grounding terminal                           | Connect to a suitable grounding object.  |
| 11  | output circuit breaker                       | Circuit breaker will stick out if an overload condition forces the UPS to disconnect itself from utility power. User can reset the circuit breaker by pushing the button inward. |

---

This Page Intentionally Left Blank

# Chapter 2

## Hardware Setup



1. Important safety information regarding the placement of this device is provided on *Safety Instructions* on page 47. Please review it before proceeding.
2. Make sure that power to all the devices you will be installing has been turned off. You must unplug the power cords of any computers that have the Keyboard Power On function.

### Mounting

---

The unit can be either desktop mounted (vertically or horizontally) or rack mounted (in a 19" rack chassis).

#### **Rack Mount**

A rail slide kit and rack mount kit is provided in the package for rack mount. The rail slide kit is installed on the rack and the rack mount kit installs the UPS to the rack. To mount the UPS, do the following:

1. Make sure the rail slide kit includes all the components. The components include 2 slide rails (1 for each side, indicated by L and R in the diagram below), 6 M6 nuts, 4 fixing studs and 8 M6 screws, as shown in the diagram below:

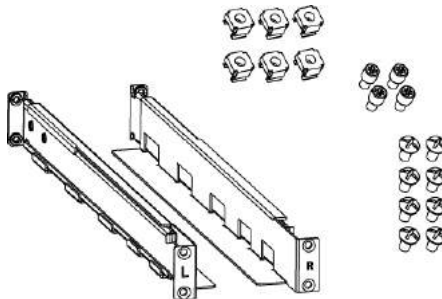

2. Insert the 4 fixing studs: Two screw holes are available on both ends of a slide rail. Screw a fixing stud into the top screw hole as shown:

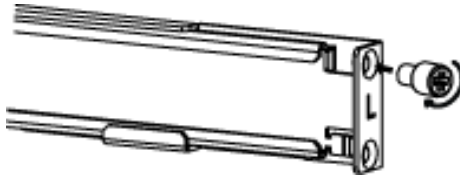

3. Have the rail near the supporting columns, pull the two ends of the rail slider apart. While at it, fit the fixing studs into the columns' holes on the same level. This step serves to hold the slider rail in place for the latter steps.

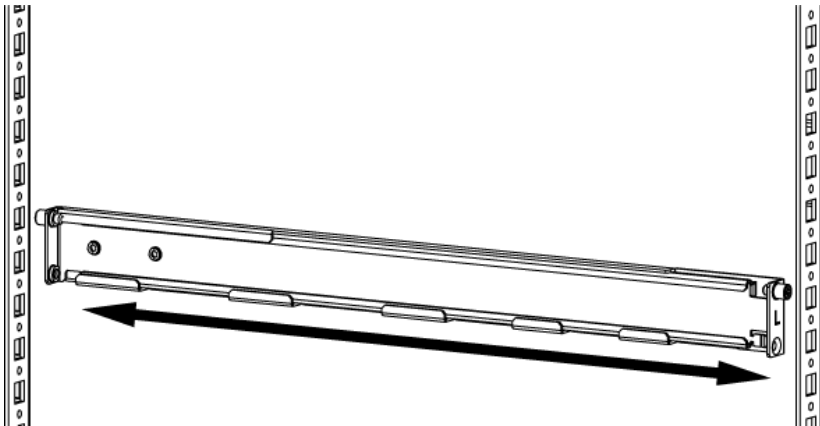

4. Screw a M6 screw into each of the bottom holes to fix the rail slider in place for both ends of the rail, and for both rail sliders (a total of 4 M6 screws are used here).

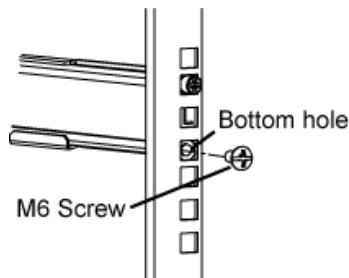

5. Insert the M6 nuts onto the support columns as show below:

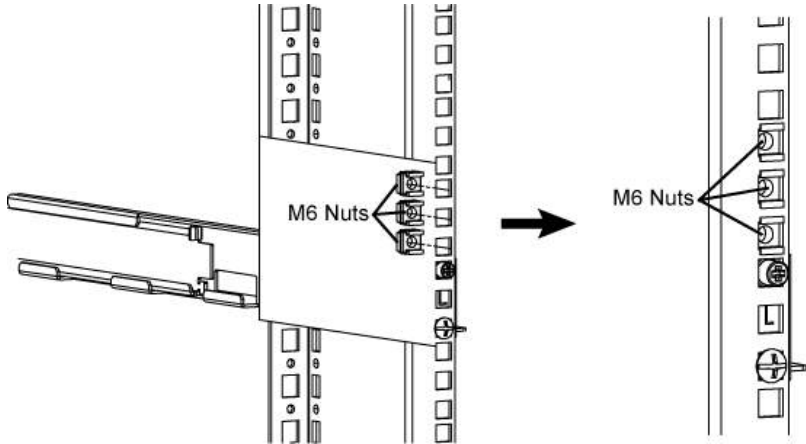

6. Attach the mounting kit onto the UPS by screwing M4 screws into the mounting kit screw holes and the UPS as shown:

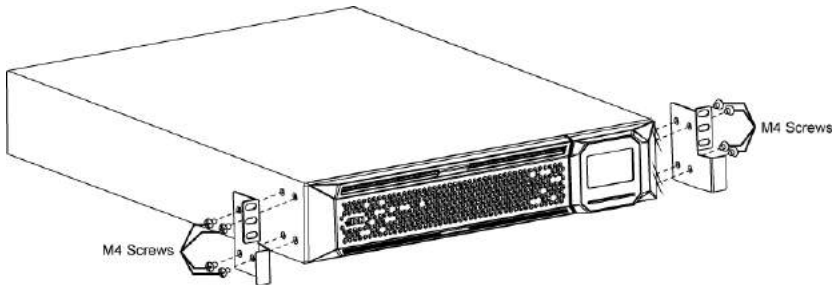

7. Fit the UPS onto the rack rails and stabilize the mounting kit (M6 screws) onto the rack as shown:

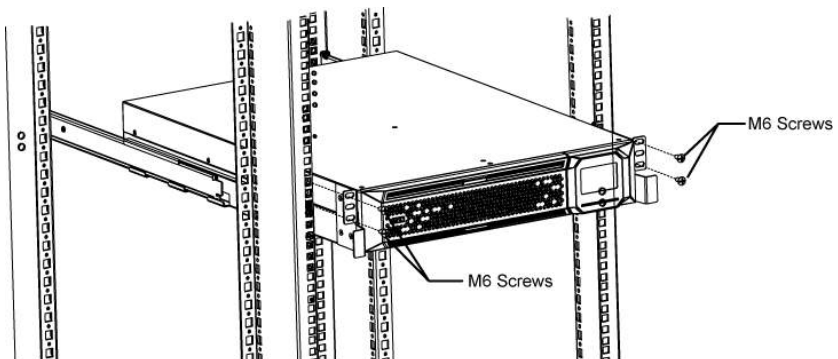

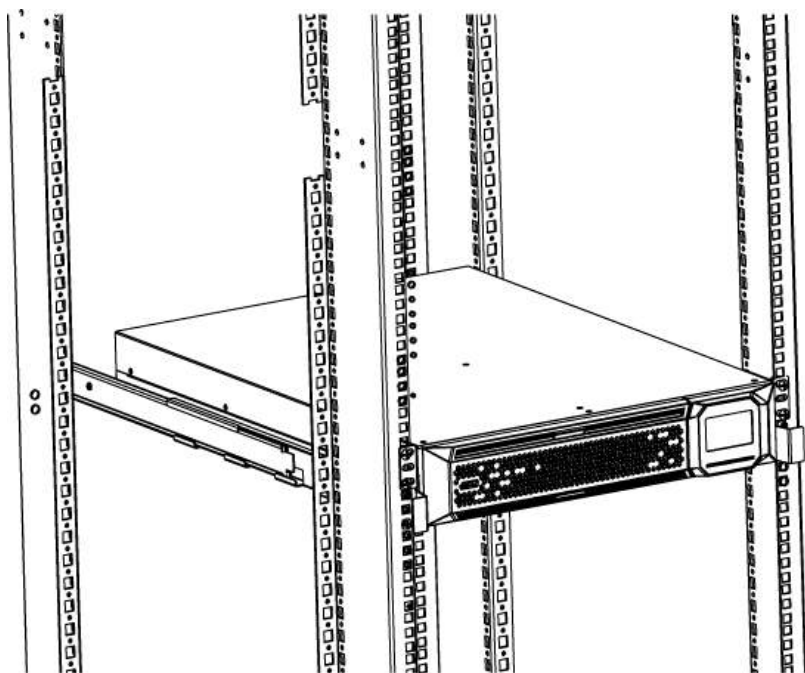

## **Vertical (Tower) Desktop Mount**

1. You can mount the unit onto the tower stand set (a set includes 2 tower stands) from the package content. Place the unit onto the tower stands.

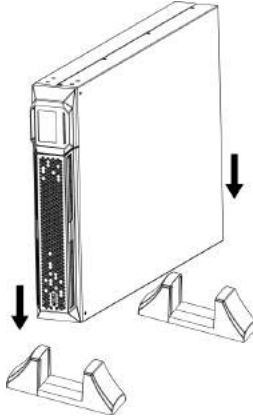

2. Remove the front panel. Pull to loosen the hooks and withdraw the panel.

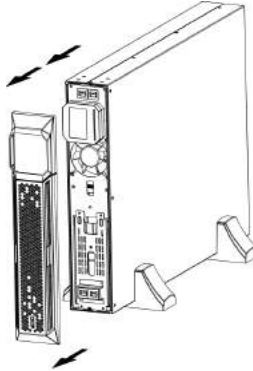

3. Turn the LCD panel such that the buttons are below the LCD screen.

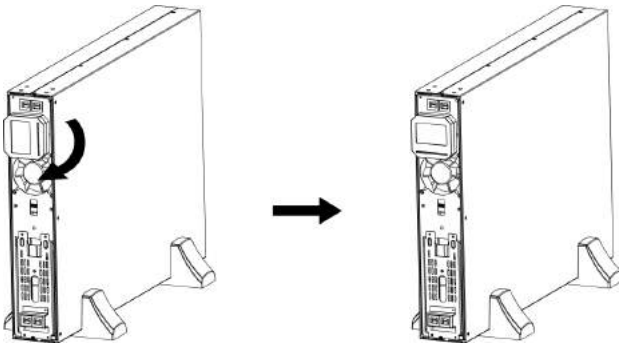

4. Replace the front panel back to the unit.

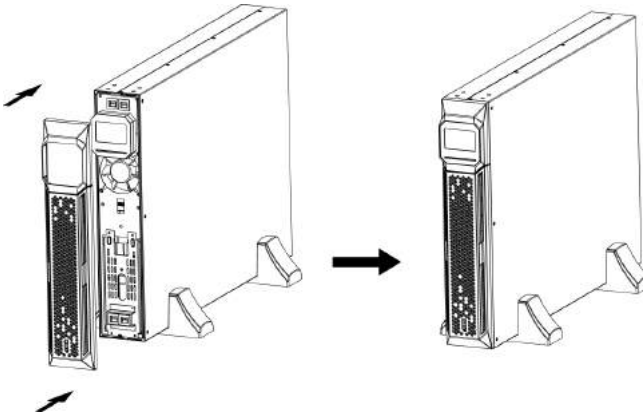

### Mounting UPS with Battery Box

If you have an extra battery box, you may vertically mount your UPS and the battery box in a single configuration if you use the extended tower stands.



2 Stand Extenders are used to extend one tower stand. The Stand Extenders (4 pcs) are from the package content of the battery box.

Follow the instructions below to assemble the extended tower stands.

1. Remove the screws from the bottom of the tower stand.

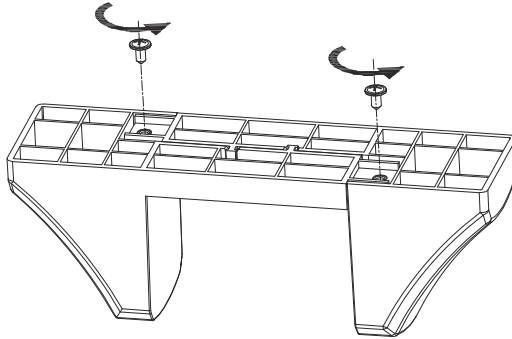

2. Bend the tower stand as shown in the diagram below:

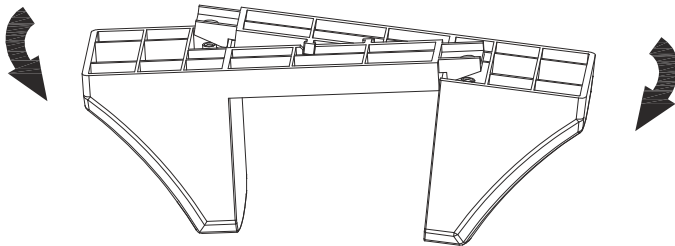

The separated tower stand pieces and two stand extenders (from the package content of the battery box) are shown below:

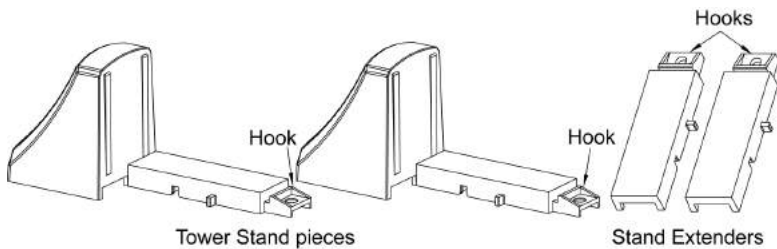

3. Orient the stand extenders as shown in the diagram below. Level and connect the extenders to the bottom of the tower stand pieces as indicated by the arrow. Make sure the hooks are properly hooked into the tower stand pieces.

Stand Extenders



4. Stabilize the stand extenders by screwing M4 screws from the hooks to the tower stand pieces.

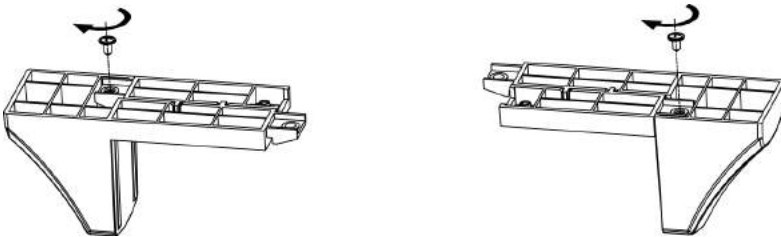

5. Orient the extended tower stand pieces as shown in the diagram below. Level and connect the hooks.

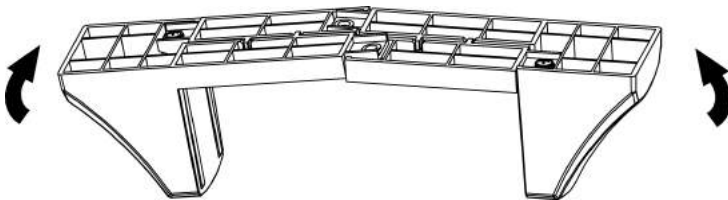

6. Stabilize the extended tower stand by screwing M4 screws from the hooks to the tower stand pieces.

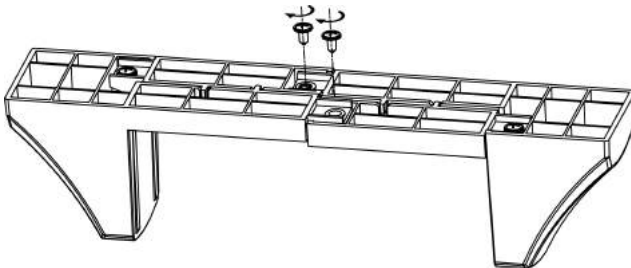

A completed extended tower stand is shown below:

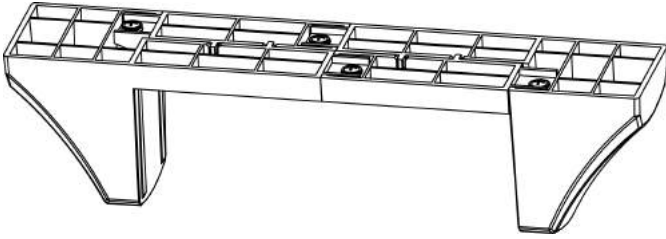

7. You can now place the UPS and a battery box onto the extended tower stands.

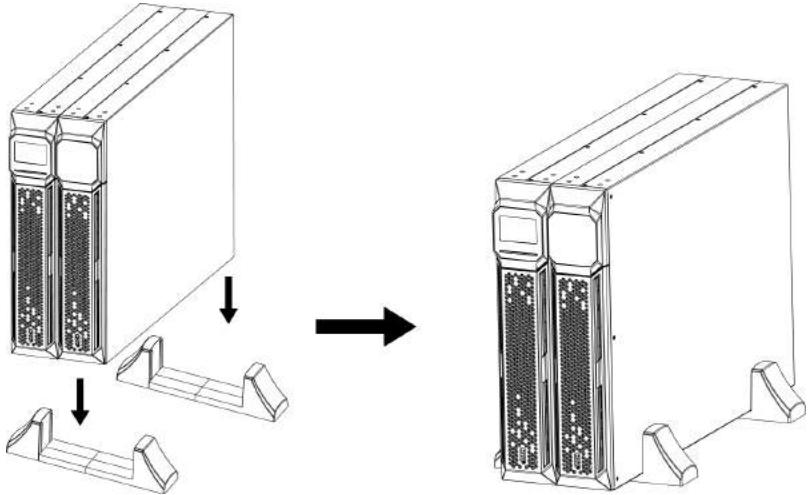

## Connecting Internal Battery

---

For safety, the internal battery of the unit is disconnected by default. Please follow the steps below to reconnect battery wires.

**Note:** It is recommended that no power is connected during this time to prevent electric shock.

---

1. Remove the front panel. Pull to loosen the hooks and withdraw the panel.

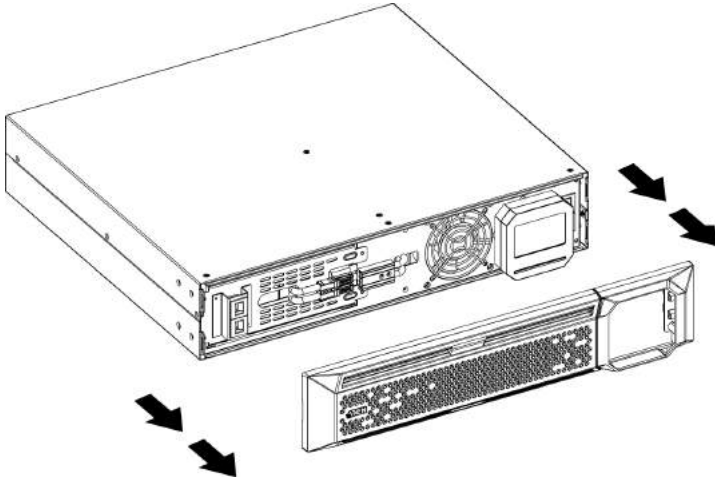

2. Connect the power connectors of the battery and the unit together.

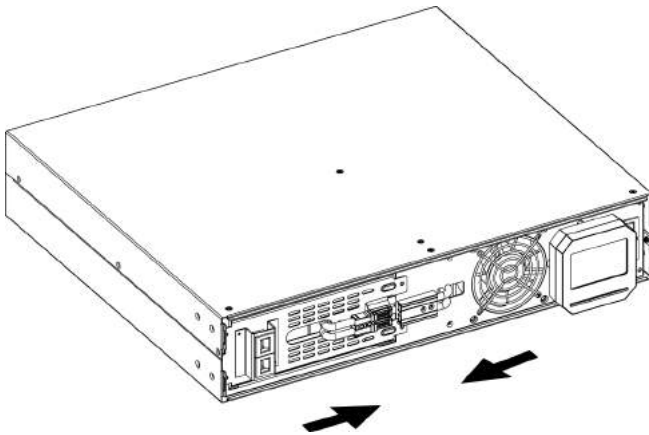

3. Replace the front panel back to the unit.

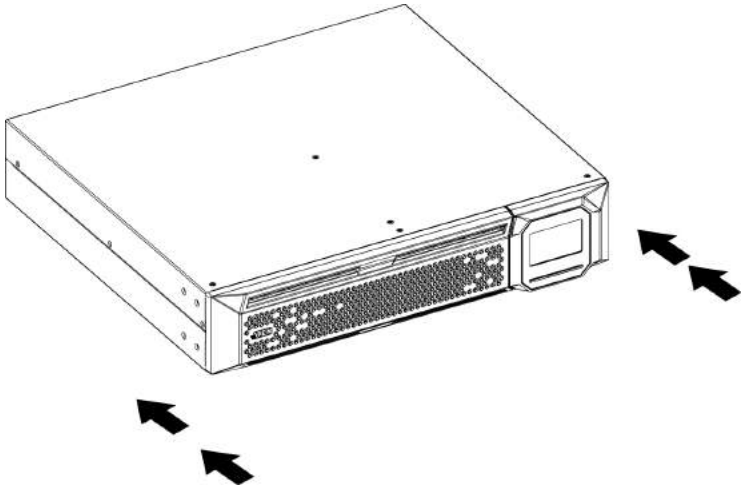

## Installation

---

Refer to the diagram following the steps below to connect the UPS:

---

**Note:** OL1000LV is the example used here.

---

1. Connect the unit's grounding terminal to a suitable grounded object.
2. Connect electrical appliances to the non-critical power outlets.
3. Connect electrical appliances (that you do not wish to have power cut off) to the critical power outlets.
4. (Optional) Connect external battery to the External Battery Connection Port. Refer to *External Battery Connection* on page 22.
5. (Optional) Connect a modem/phone/fax source (using a corresponding cable) into the surge-protected "IN" outlet. Connect an equipment (you wish to have surge protection for) to the "OUT" outlet using another modem/fax/phone cable.
6. (Optional) Connect the USB Type B end of the included USB Type A to B cable to the unit and the Type A end to a USB port on your PC.
7. (Optional) Connect the included RS-232 cable between the RS-232 port of the unit and a communication port of your PC.
8. (Optional) Connect either SNMP or AS400 card for advanced communication and monitoring options.
9. Connect this power cable to an AC power socket.

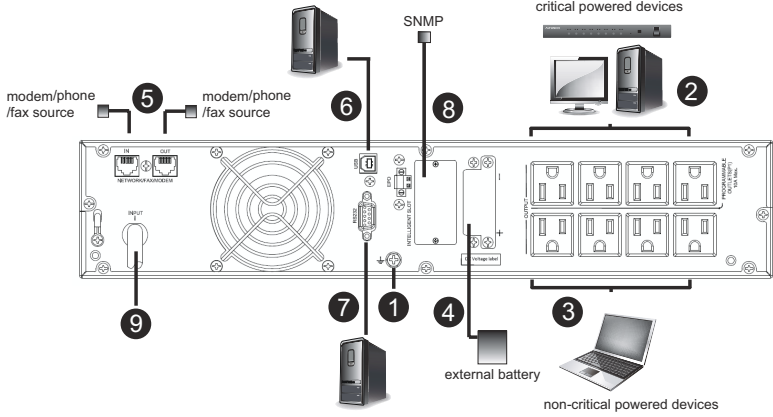

## External Battery Connection

External batteries can be purchased separately.

**Note:** When connecting external battery packs, please connect the polarity correctly. Connect positive pole of external battery pack to the positive pole of external battery connector on the UPS and negative pole of battery pack to negative pole of external battery connector on the UPS. Polarity misconnection will cause internal fault in the UPS. It is recommended to add a breaker between the positive pole of battery pack and positive pole of external battery connector on the UPS to prevent damage.

The required specification of breaker: Voltage  $\geq 1.25$  battery voltage/set; current  $\geq 50A$ .

Please choose battery size and connected numbers according to backup time requirement and UPS specifications. To extend battery lifecycle, it's recommended to use them in the temperature range of 15°C to 25°C.

Follow the steps below to connect an external battery:

1. Turn off the unit by removing the power plug from the mains.
2. Remove the front panel and disconnect the internal battery connector.

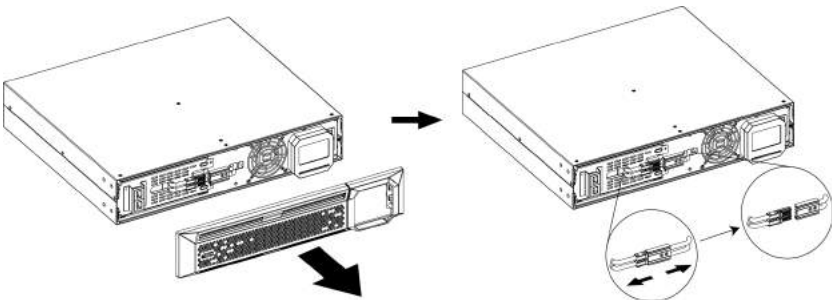

3. Remove the cover of the External Battery Connection Port using a screwdriver.

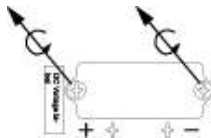



4. Plug the cable connector into the External Battery Connection Port of the unit and the battery pack(s).

---

**Note:** If you have multiple battery packs available, connect them serially. An example is shown in the diagram below (connecting the second battery connection port of the first battery pack to the first battery connection port of the second battery pack).

---

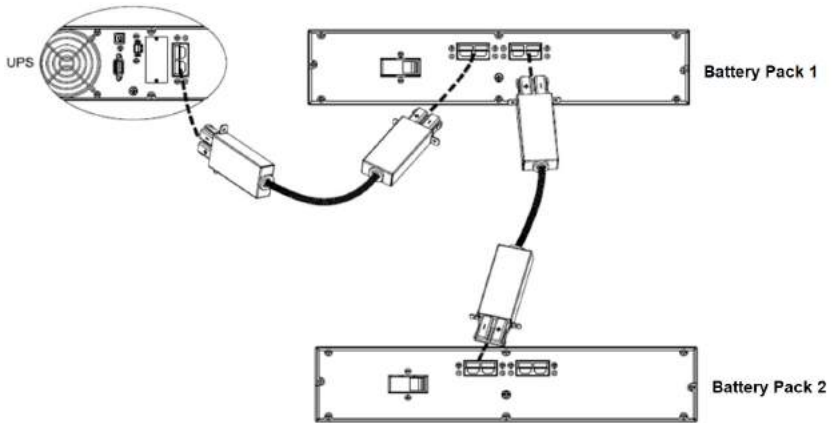

5. Stabilize the connectors to the unit and the battery pack(s) using screws. An example is shown below:

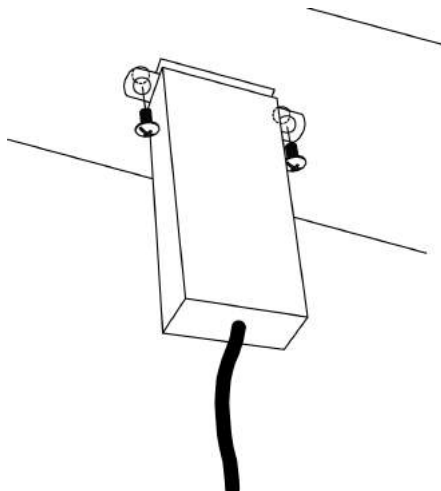

6. On the front side of the unit, reconnect the battery connector and reattach the front cover.

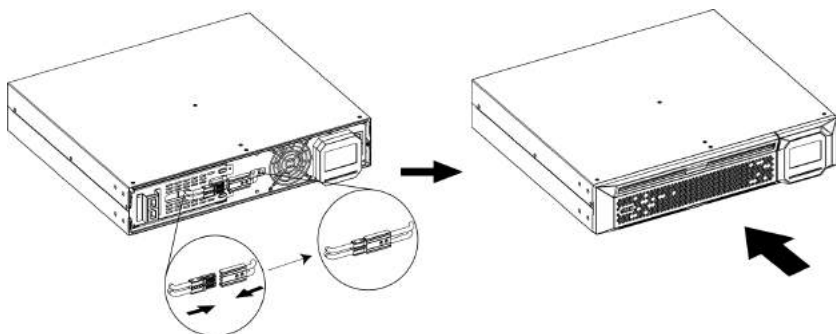

# Chapter 3

## General Operations

### Turn On the UPS

---

Press the ON/Mute button on the front panel for two seconds to power on the UPS.

Note: The battery charges fully during the first five hours of normal operation. Do not expect full battery run capability during this initial charge period.

### EPO Function

---

This UPS is equipped with an emergency power off (EPO) function. By default, the UPS is delivered from factory with Pin 1 and pin 2 closed (a metal plate is connected to Pin 1 and Pin2) for UPS normal operation. To activate the EPO function, remove two screws on EPO port and metal plate will be removed.

Note: The EPO function logic can be set up via LCD setting. Please refer to *EPO Logic Setting* on page 38 for details.

### Install Software

---

For optimal computer system protection, install the ViewPower and ShutdownWizard program to monitor/manage UPS units and to fully configure their shutdown. Use the supplied RS-232 or USB communication cable to connect the RS-232/USB port of UPS to the RS-232/USB port of PC. Then, follow below steps to install the programs.

1. Visit the product web page and go to the **Downloads** tab.
2. Download ViewPower and ShutdownWizard based on the operating system of your management computer.
3. Follow the on-screen instructions to complete the install.

This Page Intentionally Left Blank

# Chapter 4

## LCD/Button Operations

### Overview

---

The unit includes an LCD display with a three-button configuration interface.

### Button Operation

---

| Button             | Function   |
|--------------------|--|
| on / mute button   | <ul style="list-style-type: none"><li>◆ Turn on the UPS: Press and hold ON/Mute button for at least 2 seconds to turn on the UPS.</li><li>◆ Mute the alarm: After the UPS is turned on in battery mode, press and hold this button for at least 3 seconds to disable or enable the alarm system. But it's not applied to the situations when warnings or errors occur.</li><li>◆ Up key: Press this button to display previous selection in UPS setting mode.</li><li>◆ Switch to UPS self-test mode: Press ON/Mute buttons for 3 seconds to enter UPS self-testing while in AC mode, ECO mode, or converter mode.</li></ul> |
| off / enter button | <ul style="list-style-type: none"><li>◆ Turn off the UPS: Press and hold this button at least 2 seconds to turn off the UPS. UPS will be in standby mode under power normal or transfer to Bypass mode if the Bypass enable setting by pressing this button.</li><li>◆ Confirm selection key: Press this button to confirm selection in UPS setting mode.</li></ul>  |
| select button      | <ul style="list-style-type: none"><li>◆ Switch LCD message: Press this button to change the LCD message for input voltage, input frequency, input current, battery voltage, battery current, battery capacity, ambient temperature, output voltage, output frequency, load current and load percent.</li><li>◆ Setting mode: Press and hold this button for 3 seconds to enter UPS setting mode when Standby and Bypass mode.</li><li>◆ Down key: Press this button to display next selection in UPS setting mode</li></ul>  |

| Button                           | Function   |
|----------------------------------|--|
| on / mute button + select button | <ul style="list-style-type: none"> <li>Switch to bypass mode: When the main power is normal, press ON/Mute and Select buttons simultaneously for 3 seconds. Then UPS will enter to bypass mode. This action will be ineffective when the input voltage is out of acceptable range.</li> <li>Exit setting mode or return to the upper menu: When working in setting mode, press ON/Mute and Select buttons simultaneously for 0.2 seconds to return to the upper menu. If it's already in top menu, press these two buttons at the same time to exit the setting mode.</li> </ul> |





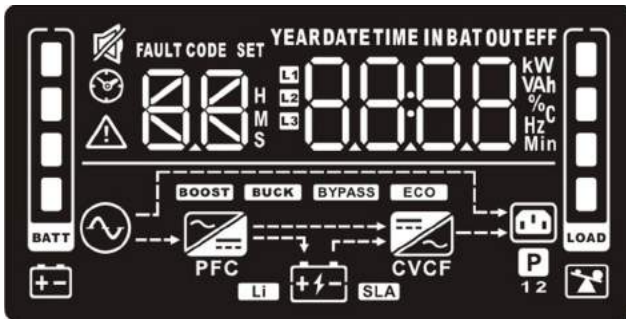





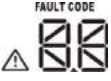

## LCD Panel



The LCD Panel is shown below:





The function is described below:

| Display                             | Function   |
|-------------------------------------|--|
| Backup time Information             |  |
|                                     | Indicates the estimated backup time.<br>H: hours, M: minute, S: second.  |
| Configuration and fault information |  |
|                                     | Indicates the configuration items, and the configuration items are listed in details in <i>UPS Setting</i> on page 33. |

| Display   | Function   |
|---|--|
|    | Indicates the warning and fault codes, and the codes are listed in details in <i>Faults Reference Code</i> on page 44 and <i>Warning Indicator</i> on page 45.   |
| Mute operation  |  |
|    | Indicates that the UPS alarm is disabled.  |
| Input, Battery, Temperature, Output & Load information                              |  |
|    | Indicate the input voltage, input frequency, input current, battery voltage, battery current, battery capacity, ambient temperature, output voltage, output frequency, load current and load percent.<br>k: kilo, W: watt, V: voltage, A: ampere, %: percent, °C: centigrade degree, Hz: frequency |
| Load Information  |  |
|    | Indicates the load level by 0-24%, 25-49%, 50-74% and 75-100%.   |
|    | Indicates overload   |
| Programmable outlets information  |  |
|    | Indicates that programmable management outlets are working.  |
| Mode operation information  |  |
|  | Indicates the UPS connects to the mains.   |
|  | Indicates the battery is working.  |
|  | Indicates charging status  |
|  | Indicates the bypass circuit is working.   |
|  | Indicates the ECO mode is enabled.   |
|  | Indicates the AC to DC circuit is working.   |

| Display   | Function  |
|---|---|
| <b>PFC</b>  | Indicates the PFC circuit is working.           |
|  | Indicates the inverter circuit is working.      |
| <b>CVCF</b>   | Indicates the UPS is working in converter mode. |
|  | Indicates the output is working.                |

Battery information

|   |  |
|---|--|
|  | Indicates the battery level by 0-24%, 25-49%, 50-74%, and 75-100%. |
|  | Indicates low battery.   |

## Audible Alarm

| Mode         | Alarm Pattern             |
|--------------|---------------------------|
| battery mode | Beep once every 5 seconds |
| low battery  | Beep once every 2 seconds |
| overload     | Beep once every second    |
| fault        | Beeps continuously        |
| bypass mode  | Beep every 10 seconds     |



## LCD Display Wordings Index

| English Letter | Display | Definition              |
|----------------|---------|-------------------------|
| ENA            | ENA     | Enable                  |
| DIS            | DIS     | Disable                 |
| ESC            | ESC     | Escape                  |
| HLS            | HLS     | High loss               |
| LLS            | LLS     | Low loss                |
| AO             | AO      | Active open             |
| AC             | AC      | Active close            |
| EAT            | EAT     | Estimated autonomy time |
| RAT            | RAT     | Running autonomy Time   |
| SD             | SD      | Shutdown                |
| OK             | OK      | OK                      |
| ON             | ON      | ON                      |
| BL             | BL      | Battery Low             |
| OL             | OL      | Overload                |
| OI             | OI      | Over input current      |
| NC             | NC      | Battery no connect      |

| English Letter | Display | Definition                |
|----------------|---------|---------------------------|
| OC             | OC      | Overcharge                |
| SF             | SF      | Site wiring fault         |
| EP             | EP      | EPO                       |
| TP             | TP      | Temperature               |
| CH             | CH      | Charger                   |
| BF             | BF      | Battery fault             |
| BV             | BV      | Bypass out range          |
| FU             | FU      | Bypass frequency unstable |
| BR             | BR      | Battery replace           |
| EE             | EE      | EEPROM error              |



## UPS Setting

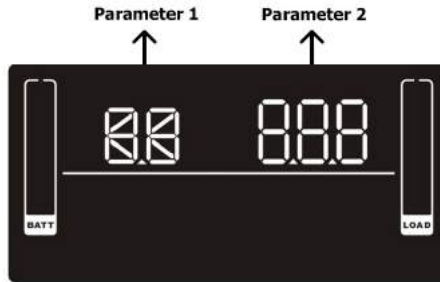



There are two parameters for the UPS as displayed in the picture below:









Parameter 1: The number shown here determines the settings you can adjust. Please refer to the table below for the settings.



Parameter 2: The number shown here is the option or value for the settings determined in parameter 1.





| Parameter 1 & Interface Display   | Parameter 2 Description   |
|---|---|
| <p><b>Output Voltage Setting</b><br/>Display: 01</p>                    | <p><b>Parameter 2: Output voltage</b></p> <ul style="list-style-type: none"> <li><b>100:</b> 100vac output voltage</li> <li><b>110:</b> 110vac output voltage</li> <li><b>115:</b> 115vac output voltage</li> <li><b>120:</b> 120vac output voltage (Default)</li> <li><b>125:</b> 125vac output voltage</li> <li><b>127:</b> 127vac output voltage (not applicable for U.S. region)</li> </ul> |
| <p><b>Enable/Disable Frequency Converter Mode</b><br/>Display: 02</p>  | <p><b>Parameter 2: Enable or disable</b> converter mode.</p> <p>You may choose the following two options:</p> <ul style="list-style-type: none"> <li><b>ENA:</b> Enable Converter mode</li> <li><b>DIS:</b> Disable Converter mode (Default)</li> </ul>   |

| Parameter 1 & Interface Display   | Parameter 2 Description  |
|---|--|
| <p><b>Output Frequency Setting</b><br/>Display: 03</p>   | <p><b>Parameter 2: Output frequency.</b><br/>You may set the initial frequency on battery mode:</p> <p><b>BAT 50:</b> 50Hz output frequency<br/><b>BAT 60:</b> 60Hz output frequency</p> <p>If converter mode is enabled, you may choose the following output frequencies:</p> <p><b>CF 50:</b> 50Hz output frequency<br/><b>CF 60:</b> 60Hz output frequency</p>  |
| <p><b>Enable/Disable ECO</b><br/>Display: 04</p>   | <p><b>Parameter 2: Enable or disable ECO function.</b><br/>You may choose the following two options:</p> <p><b>ENA:</b> Enable ECO mode<br/><b>DIS:</b> Disable ECO mode (Default)</p>   |
| <p><b>ECO Voltage Range Setting</b><br/>Display: 05</p>  <p>Display: HS</p>  | <p><b>Parameter 2: Acceptable high voltage point and low voltage point for ECO mode.</b> Press the Up or Down key to adjust the values.</p> <p><b>HLS:</b> High loss voltage in ECO mode in parameter 2.<br/>For 100/110/115/120/127 VAC models, the setting range for parameter 3 is +3V to +12V of the nominal voltage.<br/>(Default: +6V)</p> <p><b>LLS:</b> Low loss voltage in ECO mode in parameter 2.<br/>For 100/110/115/120/127 VAC models, the setting voltage for parameter 3 is -3V to -12V of the nominal voltage.<br/>(Default: -6V)</p> |





| Parameter 1 & Interface Display  | Parameter 2 Description  |
|--|--|
| <p><b>Enable/Disable Bypass when UPS is off</b><br/>Display: 06</p>   | <p><b>Parameter 2: Enable or disable Bypass function.</b><br/>You may choose the following two options:<br/><b>ENA:</b> Enable bypass<br/><b>DIS:</b> Disable bypass (Default)</p>   |
| <p><b>Bypass Voltage Range Setting</b><br/>Display: 07</p>  <p>Display: HS</p>  | <p><b>Parameter 2: Acceptable high voltage point and acceptable low voltage point for Bypass mode.</b> Press the Up or Down key to adjust the values.<br/><b>HLS:</b> Bypass high voltage point</p> <p>For 100/110/115/120/127 VAC models:<br/><b>120-140:</b> setting the high voltage point range of parameter 3 to between 120Vac and 140Vac. (Default: 132Vac)<br/><b>LLS:</b> Bypass low voltage point</p> <p>For 100/110/115/120/127 VAC models:<br/><b>85-115:</b> setting the low voltage point range of parameter 3 to between 85Vac and 115Vac. (Default: 85Vac)</p> |

| Parameter 1 & Interface Display   | Parameter 2 Description  |
|---|--|
| <p><b>Bypass Frequency Range Setting</b><br/>Display: 08</p>  <p>Display: HS</p>  | <p><b>Parameter 2: Acceptable high frequency point and acceptable low frequency point for Bypass mode.</b> Press the Up or Down key to adjust the values.</p> <p><b>HLS:</b> Bypass high frequency point<br/>For 50Hz output frequency models:<br/><b>51-55Hz:</b> setting the frequency high loss point from 51Hz to 55HZ(Default: 53.0Hz)<br/>For 60Hz output frequency models:<br/><b>61-65Hz:</b> setting the frequency high loss point from 61Hz to 65Hz(Default: 63.0Hz)</p> <p><b>LLS:</b> Bypass low Frequency point<br/>For 50Hz output frequency models:<br/><b>45-49Hz:</b> setting the frequency low loss point from 45Hz to 49HZ(Default: 47.0Hz)<br/>For 60Hz output frequency models:<br/><b>55-59Hz:</b> setting the frequency low loss point from 55Hz to 59Hz(Default: 57.0Hz)</p> |
| <p><b>Enable/Disable Programmable Outlets</b><br/>Display: 09</p>   | <p><b>Parameter 2: Enable or disable</b> programmable outlets.</p> <p><b>ENA:</b> Enable Programmable outlets<br/><b>DIS:</b> Disable Programmable outlets (Default)</p>   |
| <p><b>Programmable Outlet Backup Time Setting</b><br/>Display: 10</p>    | <p><b>Parameter 2: Backup time limits for programmable outlets.</b></p> <p><b>0-999:</b> setting the backup time limits in minutes from 0-999 for programmable outlets which connect to non-critical devices on battery mode. (Default: 999)</p>   |

| Parameter 1 & Interface Display  | Parameter 2 Description   |
|--|---|
| <p><b>Autonomy Limitation Setting</b><br/>Display: 11</p>  <p>The LCD display shows '11 M' on the left and '9999' on the right. Above the numbers is the word 'SET'. Below the numbers is a battery icon with a plus and minus sign. The left side of the display is labeled 'BATT' and the right side is labeled 'LOAD'.</p>   | <p><b>Parameter 2: Backup time on battery mode</b> for general outlets.</p> <p><b>0-999:</b> Set the backup time (in minutes) from 0-999 for general outlets on battery mode.</p> <p><b>DIS:</b> Disable the autonomy limitation and the backup time will depend on battery capacity. (Default)</p> <p><b>Note:</b> When setting as “0”, the backup time will be only 10 seconds.</p>   |
| <p><b>Battery Total AH setting</b><br/>Display: 12</p>  <p>The LCD display shows '12' on the left and '7 Ah' on the right. Above the numbers is the word 'SET'. Below the numbers is a battery icon with a plus and minus sign. The left side of the display is labeled 'BATT' and the right side is labeled 'LOAD'.</p>        | <p><b>Parameter 2: Battery total AH</b> of the UPS.</p> <p><b>7-999:</b> Set the battery total capacity from 7-999 in AH. Please set the correct battery total capacity if external battery pack is connected.</p>  |
| <p><b>Maximum Charger Current Setting</b><br/>Display: 13</p>  <p>The LCD display shows '13' on the left and '8 A' on the right. Above the numbers is the word 'SET'. Below the numbers is a battery icon with a plus and minus sign. The left side of the display is labeled 'BATT' and the right side is labeled 'LOAD'.</p> | <p><b>Parameter 2: Charger maximum current.</b></p> <p>For low voltage model with 24/36/48VDC</p> <p><b>1/2/4/6/8:</b> Set maximum charger current to 1/2/4/6/8 Ampere. (Default: 2A)</p> <p>For low voltage and high voltage model with 72/96VDC</p> <p><b>1/2/4/6/8:</b> Set maximum charger current to 1/2/4/6/8 Ampere. (Default: 2A)</p> <p><b>Note:</b> Please set the appropriate charger current based on battery capacity used. The recommended charging current is 0.1C~0.3C of battery capacity as following table for reference.</p> <p><b>Warning:</b> Setting the current too high may cause damage to the device.</p> <p>For the recommended charger current, please refer to <i>Suggested Battery Charger Current</i> on page 40.</p> |

| Parameter 1 & Interface Display  | Parameter 2 Description  |
|--|--|
| <p><b>Charger Boost Voltage Setting</b><br/>Display: 14</p>  <p>The interface display shows a black background with white text. At the top center, the word 'SET' is displayed. Below it, the number '14' is shown on the left and '2.36 V' on the right. A horizontal line is positioned below the numbers. On the far left and right sides, there are vertical bars with the labels 'BATT' and 'LOAD' respectively.</p>   | <p><b>Parameter 2: Charger boost voltage.</b><br/><b>2.25-2.40:</b> setting the charger boost voltage from 2.25 V/cell to 2.40V/cell. (Default: 2.36V/cell)</p>  |
| <p><b>Charger Float Voltage Setting</b><br/>Display: 15</p>  <p>The interface display shows a black background with white text. At the top center, the word 'SET' is displayed. Below it, the number '15' is shown on the left and '2.28 V' on the right. A horizontal line is positioned below the numbers. On the far left and right sides, there are vertical bars with the labels 'BATT' and 'LOAD' respectively.</p>   | <p><b>Parameter 2: Charger float voltage.</b><br/><b>2.20-2.33:</b> Set the charger float voltage from 2.20 V/cell to 2.33V/cell. (Default: 2.28V/cell)</p>  |
| <p><b>EPO Logic Setting</b><br/>Display: 16</p>  <p>The interface display shows a black background with white text. At the top center, the word 'SET' is displayed. Below it, the number '16' is shown on the left and 'AO' on the right. A horizontal line is positioned below the numbers. On the far left and right sides, there are vertical bars with the labels 'BATT' and 'LOAD' respectively.</p>  | <p><b>Parameter 2: EPO function control logic.</b><br/><b>AO:</b> Active Open (Default). When selected, it will activate EPO function with Pin 1 and Pin 2 in open status.<br/><b>AC:</b> Active Close. When selected, it will activate EPO function with Pin 1 and Pin 2 in close status.</p> |
| <p><b>Enable/Disable Site Fault Detection</b><br/>Display: 17</p>  <p>The interface display shows a black background with white text. At the top center, the word 'SET' is displayed. Below it, the number '17' is shown on the left and 'ENA' on the right. A horizontal line is positioned below the numbers. On the far left and right sides, there are vertical bars with the labels 'BATT' and 'LOAD' respectively. A small circular icon with a lightning bolt is located below the 'BATT' label.</p> | <p><b>Parameter 2: Enable/disable sit fault detection.</b><br/><b>ENA:</b> Enable (Default).<br/><b>DIS:</b> Disable.</p>  |



| Parameter 1 & Interface Display  | Parameter 2 Description   |
|--|---|
| <p><b>Display Setting for Autonomy Time</b><br/>Display: 18</p>   | <p><b>Parameter 2: Display setting for autonomy time</b></p> <p><b>EAT:</b> when selected, the remaining autonomy time will be displayed. (Default)</p> <p><b>RAT:</b> When selected, the accumulated autonomy time so far will be displayed.</p>   |
| <p><b>Acceptable Input Voltage Range Setting</b><br/>Display: 19</p>  <p>Display: HS</p>  | <p><b>Parameter 2: Acceptable high voltage point and acceptable low voltage point</b> for input voltage range. Press the Up or Down key to adjust the values.</p> <p><b>HLS:</b> Input high voltage point<br/>For 100/110/115/120/127 VAC models:<br/><b>140/145/150:</b> setting the high voltage point in parameter 2. (Default: 150Vac)</p> <p><b>LLS:</b> Bypass low voltage point<br/>For 100/110/115/120/127 VAC models:<br/><b>55/60/65/70/75/80:</b> setting the low voltage point in parameter 2. (Default: 55Vac)</p> |
| <p><b>Exit</b><br/>Display: 00</p>    | <p>Exit UPS Setting.</p>  |





## **Suggested Battery Charger Current**

|               | <b>AH</b> | <b>Suggested Charging Current</b> |
|---------------|-----------|-----------------------------------|
| 1000VA (2B)   | 9         | 2                                 |
| +1 BP24V18AH  | 27        | 4                                 |
| +2 BP24V18AH  | 45        | 6                                 |
| +3 BP24V18AH  | 63        | 8                                 |
| +4 BP24V18AH  | 81        | 10                                |
| +5 BP24V18AH  | 99        | 10                                |
| +6 BP24V18AH  | 117       | 12                                |
| +7 BP24V18AH  | 135       | 12                                |
| +8 BP24V18AH  | 153       | 12                                |
| +9 BP24V18AH  | 171       | 12                                |
| +10 BP24V18AH | 189       | 12                                |
|               |           |                                   |
| 1000VA (3B)   | 7         | 2                                 |
| +1 BP36V18AH  | 25        | 4                                 |
| +2 BP36V18AH  | 43        | 6                                 |
| +3 BP36V18AH  | 61        | 8                                 |
| +4 BP36V18AH  | 79        | 8                                 |
| +5 BP36V18AH  | 97        | 10                                |
| +6 BP36V18AH  | 115       | 12                                |
| +7 BP36V18AH  | 133       | 12                                |
| +8 BP36V18AH  | 151       | 12                                |
| +9 BP36V18AH  | 169       | 12                                |
| +10 BP36V18AH | 187       | 12                                |
|               |           |                                   |
| 1500VA (3B)   | 9         | 2                                 |
| +1 BP36V18AH  | 27        | 4                                 |

|               | <b>AH</b> | <b>Suggested Charging Current</b> |
|---------------|-----------|-----------------------------------|
| +2 BP36V18AH  | 45        | 6                                 |
| +3 BP36V18AH  | 63        | 8                                 |
| +4 BP36V18AH  | 81        | 10                                |
| +5 BP36V18AH  | 99        | 10                                |
| +6 BP36V18AH  | 117       | 12                                |
| +7 BP36V18AH  | 135       | 12                                |
| +8 BP36V18AH  | 153       | 12                                |
| +9 BP36V18AH  | 171       | 12                                |
| +10 BP36V18AH | 189       | 12                                |
|               |           |                                   |
| 2000VA (4B)   | 9         | 2                                 |
| +1 BP48V18AH  | 27        | 4                                 |
| +2 BP48V18AH  | 45        | 6                                 |
| +3 BP48V18AH  | 63        | 8                                 |
| +4 BP48V18AH  | 81        | 10                                |
| +5 BP48V18AH  | 99        | 10                                |
| +6 BP48V18AH  | 117       | 12                                |
| +7 BP48V18AH  | 135       | 12                                |
| +8 BP48V18AH  | 153       | 12                                |
| +9 BP48V18AH  | 171       | 12                                |
| +10 BP48V18AH | 189       | 12                                |
|               |           |                                   |
| 2000VA (6B)   | 7         | 2                                 |
| +1 BP72V18AH  | 25        | 4                                 |
| +2 BP72V18AH  | 43        | 6                                 |
| +3 BP72V18AH  | 61        | 8                                 |
| +4 BP72V18AH  | 79        | 8                                 |

|               | <b>AH</b> | <b>Suggested Charging Current</b> |
|---------------|-----------|-----------------------------------|
| +5 BP72V18AH  | 97        | 10                                |
| +6 BP72V18AH  | 115       | 12                                |
| +7 BP72V18AH  | 133       | 12                                |
| +8 BP72V18AH  | 151       | 12                                |
| +9 BP72V18AH  | 169       | 12                                |
| +10 BP72V18AH | 187       | 12                                |
|               |           |                                   |
| 3000VA (6B)   | 9         | 2                                 |
| +1 BP72V18AH  | 27        | 4                                 |
| +2 BP72V18AH  | 45        | 6                                 |
| +3 BP72V18AH  | 63        | 8                                 |
| +4 BP72V18AH  | 81        | 10                                |
| +5 BP72V18AH  | 99        | 10                                |
| +6 BP72V18AH  | 117       | 12                                |
| +7 BP72V18AH  | 135       | 12                                |
| +8 BP72V18AH  | 153       | 12                                |
| +9 BP72V18AH  | 171       | 12                                |
| +10 BP72V18AH | 189       | 12                                |

## Operating Mode Description

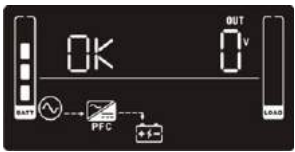

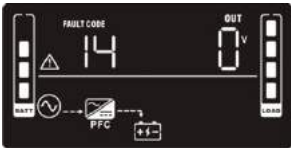









| Operating Mode           | LCD Display   | Description   |
|--------------------------|---|---|
| Online Mode              |    | When the input voltage is within acceptable range, the UPS will provide pure and stable AC power for output. The UPS will also charge the battery.  |
| ECO Mode                 |    | <b>The energy saving mode:</b> When the input voltage is within the voltage regulation range, the UPS will bypass voltage for output to save energy. The UPS will also charge the battery.                              |
| Frequency Converter Mode |    | When the input frequency is within 40 Hz to 70 Hz, the UPS can be set at a constant output frequency of 50 Hz or 60 Hz. The UPS will also charge the battery.   |
| Battery Mode             |   | When the input voltage is beyond the acceptable range or power failure, the UPS will provide backup power from the battery and alarm will beep every 5 seconds.   |
| Bypass Mode              |  | When the input voltage is within acceptable range but the UPS is overloaded, the UPS will enter bypass mode. Alternatively, you can set the UPS to bypass mode using the front panel. Alarm will beep every 10 seconds. |
| Standby Mode             |  | The UPS is powered off and will not output power. The UPS will charge the battery.  |

| Operating Mode | LCD Display   | Description   |
|----------------|---|---|
| Fault Mode     |  | When a fault has occurred, the ERROR icon and the fault code will be displayed. |

## Faults Reference Code

| Fault Event              | Fault Code | Icon | Fault Event              | Fault Code | Icon  |
|--------------------------|------------|------|--------------------------|------------|---|
| Bus start fail           | 01         | x    | Battery voltage too high | 27         | x   |
| Bus over                 | 02         | x    | Battery voltage too low  | 28         | x   |
| Bus under                | 03         | x    | Charger output short     | 2A         | x   |
| Inverter soft start fail | 11         | x    | Over temperature         | 41         | x   |
| Inverter voltage high    | 12         | x    | Overload                 | 43         |  |
| Inverter voltage low     | 13         | x    | Charger failure          | 45         | x   |
| Inverter output short    | 14         | x    | Over input current       | 49         | x   |

## Warning Indicator

| Warning                     | Icon (Flashing)   | Code | Alarm  |
|-----------------------------|---|------|--|
| Low Battery                 |    | bL   | Beeps every 2 seconds  |
| Overload                    |    | OL   | Beeps every second   |
| Over input current          |    | OI   | Beeps twice every 10 seconds   |
| Battery is not connected    |    | NC   | Beeps every 2 seconds  |
| Over Charge                 |    | OC   | Beeps every 2 seconds  |
| Site wiring fault           |    | SF   | Beeps every 2 seconds  |
| EPO enable                  |    | EP   | Beeps every 2 seconds  |
| Over temperature            |   | TP   | Beeps every 2 seconds  |
| Charger failure             |  | CH   | Beeps every 2 seconds  |
| Battery fault               |  | bF   | Beeps every 2 seconds<br>(UPS will be off to remind users something is wrong with the battery) |
| Out of bypass voltage range |  | bV   | Beeps every 2 seconds  |
| Bypass frequency unstable   |  | FU   | Beeps every 2 seconds  |
| Battery replacement         |  | bR   | Beeps every 2 seconds  |

| Warning      | Icon (Flashing)   | Code | Alarm                 |
|--------------|---|------|-----------------------|
| EEPROM error |  | EE   | Beeps every 2 seconds |

NOTE: “Site Wiring Fault” function can be enabled/disabled via software. Please check the software manual for the details.



## **Safety Instructions**

---

### **Transportation**

- ◆ Please only transport the UPS system in the original package for shock and impact protection.

### **Preparation**

- ◆ Condensation may occur if the UPS system is moved directly from cold to warm environment. The UPS system must be absolutely dry before being installed. Please allow at least two hours for the UPS system to acclimate the environment.
- ◆ Do not install the UPS system near water or in moist environment.
- ◆ Do not install the UPS system in direct sunlight exposure or near heating sources.
- ◆ Do not block ventilation holes in the UPS housing.

### **Installation**

- ◆ Do not connect appliances or devices which would overload the UPS system (e.g. laser printers) to the UPS output sockets.
- ◆ Place cables in such a way that no one can step on or trip over them.
- ◆ Do not connect domestic appliances such as hair dryers to UPS output sockets.
- ◆ The UPS can be operated by any individuals with no previous experience.
- ◆ Connect the UPS system only to an earthed shockproof outlet which must be easily accessible and close to the UPS system.
- ◆ Please use only VDE-tested, CE-marked (or UL-marked for 120 VAC models) mains cable (e.g. the mains cable of your computer) to connect the UPS system to the building wiring outlet (shockproof outlet).
- ◆ Please use only VDE-tested, CE-marked (or UL-marked for 120 VAC models) power cables to connect the loads to the UPS system.
- ◆ When installing the equipment, it should ensure that the sum of the leakage current of the UPS and the connected devices does not exceed 3.5mA.

- ◆ Temperature Rating - Units are considered acceptable for use in a maximum ambient of 40°C (104°F).
- ◆ For Pluggable Equipment - The socket-outlet shall be installed near the equipment and shall be easily accessible.
- ◆ For normal operation of the UPS (at full load UPS), it is required to keep the unit below a maximum altitude of 3000m.

## **Operation**

- ◆ Do not disconnect the mains cable on the UPS system or the building wiring outlet (shockproof socket outlet) during operations since this would cancel the protective earthing of the UPS system and of all connected loads.
- ◆ The UPS system features its own, internal current source (batteries). The UPS output sockets or output terminals block may be electrically live even if the UPS system is not connected to the building wiring outlet.
- ◆ In order to fully disconnect the UPS system, first press the OFF/Enter button to disconnect the mains.
- ◆ Prevent no fluids or other foreign objects from entering the inside of the UPS system.
- ◆ To reduce the risk of fire, connect only to a circuit provided with X (in ampere, refer to the table below) maximum branch circuit overcurrent protection in accordance with the National Electrical Code, ANSI/NFPA 70 and the Canadian Electrical Code, Part I, C22.1.

| <b>Model</b>                 | <b>X</b> |
|------------------------------|----------|
| OL1000LV, OL1500LV, OL2000LV | 20A      |
| OL3000LV                     | 40A      |

---

## **Maintenance, service and faults**

- ◆ The UPS system operates with hazardous voltages. Repairs may be carried out only by qualified maintenance personnel.
- ◆ Caution - Risk of electric shock. Even after the unit is disconnected from the mains (building wiring outlet), components inside the UPS system are still connected to the battery and electrically live and dangerous.
- ◆ Before carrying out any kind of service and/or maintenance, disconnect the batteries and verify that no current is present and no hazardous voltage exists in the terminals of high capability capacitor such as BUS-capacitors.
- ◆ Only persons are adequately familiar with batteries and with the required precautionary measures may replace batteries and supervise operations. Unauthorized persons must be kept well away from the batteries.
- ◆ Caution - Risk of electric shock. The battery circuit is not isolated from the input voltage. Hazardous voltages may occur between the battery terminals and the ground. Before touching, please verify that no voltage is present!
- ◆ Caution - Do not dispose of batteries in a fire. The batteries may explode.
- ◆ Caution - Do not open or mutilate batteries. Released electrolyte is harmful to the skin and eyes. It may be toxic.
- ◆ Batteries may cause electric shock and have a high short-circuit current. Please take the precautionary measures specified below and any other measures necessary when working with batteries:
  - ◆ Remove watches, rings, or other metal objects.
  - ◆ Use tools with insulated handles.
  - ◆ Wear rubber gloves and boots.
  - ◆ Do not lay tools or metal parts on top of batteries.
  - ◆ Disconnect charging source and load prior to installing or maintaining the battery.
  - ◆ Remove battery grounds during installation and maintenance to reduce likelihood of shock. Remove the connection from ground if any part of the battery is determined to be grounded.
- ◆ For internal battery:
  - ◆ Instructions shall carry sufficient information to enable the replacement of the battery with a suitable manufacturer and catalogue number.
  - ◆ Safety instructions to allow access by Service Personnel shall be stated in the installation/service handbook.

- ◆ If batteries are to be installed by Service Personnel, instructions for interconnections, including terminal torque, shall be provided.
- ◆ Do not attempt to dispose of batteries by burning them. This could cause battery explosion.
- ◆ Do not open or destroy batteries. Escaping electrolyte can cause injury to the skin and eyes. It may be toxic.
- ◆ Please replace the fuse only with the same type and amperage in order to avoid fire hazards.
- ◆ Do not dismantle the UPS system.

**Only for 110/120 VAC system:**

- ◆ NOTE: This equipment has been tested and found to comply with the limits for a Class A digital device, pursuant to part 15 of the FCC Rules. These limits are designed to provide reasonable protection against harmful interference when the equipment is operated in a commercial environment. This equipment generates, uses, and can radiate radio frequency energy and, if not installed and used in accordance with the instruction manual, may cause harmful interference to radio communications. Operation of this equipment in a residential area is likely to cause harmful interference in which case the user will be required to correct the interference at his own expense.
- ◆ WARNING: Changes or modifications not expressly approved by the party responsible for compliance could void the user's authority to operate the equipment.

---

## Technical Support

---

### International

- ◆ For online technical support – including troubleshooting, documentation, and software updates: <http://eservice.aten.com>
- ◆ For telephone support, see *Telephone Support* on page iii.

### North America

|                          |  |   |
|--------------------------|--|---|
| Email Support            |  | <a href="mailto:support@aten-usa.com">support@aten-usa.com</a>  |
| Online Technical Support | Troubleshooting<br>Documentation<br>Software Updates | <a href="http://eservice.aten.com">http://eservice.aten.com</a> |
| Telephone Support        |  | 1-888-999-ATEN ext 4988<br>1-949-428-1111                       |

When you contact us, please have the following information ready beforehand:

- ◆ Product model number, serial number, and date of purchase.
- ◆ Your computer configuration, including operating system, revision level, expansion cards, and software.
- ◆ Any error messages displayed at the time the error occurred.
- ◆ The sequence of operations that led up to the error.
- ◆ Any other information you feel may be of help.

# Specifications

## LV Series

| ATEN Model Name       | OL1000 LV   | OL1500 LV                              | OL2000 LV                              | OL3000 LV                              |
|-----------------------|---|--|--|--|
| <b>General</b>        |   |  |  |  |
| UPS Topology          | Double-Conversion   |  |  |  |
| Energy Saving (max)   | >96% (ECO)<br>>89% (AC)<br>>88% (Batt)  | >96% (ECO)<br>>90% (AC)<br>>89% (Batt) | >96% (ECO)<br>>91% (AC)<br>>90% (Batt) | >96% (ECO)<br>>91% (AC)<br>>90% (Batt) |
| <b>Input</b>          |   |  |  |  |
| Voltage               | 100 / 110 / 115 / 120 / 125 / 127 V AC<br>(127 V AC not applicable for U.S. region)   |  |  |  |
| Input Voltage Range   | 80-150 V AC $\pm$ 5% @ 100% load<br>55-150 V AC $\pm$ 5% @ 50% load<br>Derate capacity to 80% when the output voltage is adjusted to 100 V AC |  |  |  |
| Input Frequency Range | 40 Hz - 70 Hz   |  |  |  |
| Rated input current   | 9.3 A   | 13.2 A                                 | 17.6 A                                 | 26.4 A                                 |
| Input Power Factor    | $\geq$ 0.99 @ nominal voltage (100% load)   |  |  |  |
| Cold Start            | Yes   |  |  |  |
| Plug Type             | NEMA 5-15P  | NEMA 5-20P                             | NEMA L5-30P                            |  |
| Power Cord            | 6ft   |  |  |  |
| <b>Output</b>         |   |  |  |  |
| VA                    | 1000  | 1500                                   | 2000                                   | 3000                                   |
| Watts                 | 1000  | 1430                                   | 1930                                   | 2850                                   |
| On Battery Waveform   | Sine Wave   |  |  |  |
| On Battery Voltage    | 100* / 110* / 115 / 120 / 125 / 127 V AC<br>(127 V AC not applicable for U.S. region)   |  |  |  |

| ATEN Model Name                     | OL1000 LV  | OL1500 LV      | OL2000 LV | OL3000 LV                           |
|-------------------------------------|--|----------------|-----------|-------------------------------------|
| On Battery Frequency                | 50 / 60 Hz $\pm$ 0.1 Hz  |                |           |                                     |
| Total Outlets                       | 8  |                |           | 7                                   |
| Outlet Type                         | (8) NEMA 5-15R   | (8) NEMA 5-20R |           | (6) NEMA 5-20R +<br>(1) NEMA L5-30R |
| Outlets - Battery & Surge Protected | 8  |                |           | 7                                   |
| Rated Power Factor                  | >0.96  | 0.97           |           | 0.96                                |
| Crest Factor                        | 3:1  |                |           |                                     |
| Harmonic Distortion                 | $\leq$ 2 % THDv (Linear Load)<br>$\leq$ 4 % THDv (Non-linear Load) |                |           |                                     |
| Voltage Regulation                  | $\pm$ 1% (Batt)  |                |           |                                     |
| Transfer Time (AC to Batt.)         | 0 ms   |                |           |                                     |
| Transfer Time (Inverter to Bypass)  | 4 ms (ECO)   |                |           |                                     |

**Battery**

|                            |   |                |                |                |
|----------------------------|---|----------------|----------------|----------------|
| Runtime at Half Load (min) | Half load 10.1  | Half load 10.3 | Half load 10.0 | Half load 10.1 |
| Runtime at Full Load (min) | Full load 2.95  | Full load 2.96 | Full load 2.95 | Full load 2.96 |
| Battery Type               | Sealed Lead-Acid  |                |                |                |
| Battery Pack Voltage       | 24 V  | 36 V           | 48 V           | 72 V           |
| Battery Size               | 12V/9AH   | 12V/9AH        | 12V/9AH        | 12V/9AH        |
| Battery Quantity           | 2   | 3              | 4              | 6              |
| Hot-Swappable              | Yes   |                |                |                |
| Typical Recharge Time      | 3 hours recover to 95% capacity @ 2 A charging current. Max charger current 8 A |                |                |                |

| <b>ATEN Model Name</b>            | <b>OL1000 LV</b> | <b>OL1500 LV</b> | <b>OL2000 LV</b> | <b>OL3000 LV</b> |
|-----------------------------------|------------------|------------------|------------------|------------------|
| Extended Battery Module           | BP24V18AH        | BP36V18AH        | BP48V18AH        | BP72V18AH        |
| Replacement Battery Pack          | BC24V9AH         | BC36V9AH         | BC48V9AH         | BC72V9AH         |
| Replacement Battery Pack Quantity | 1                | 1                | 1                | 1                |

**Physical Properties**

|                                       |                |      |                |                |
|---------------------------------------|----------------|------|----------------|----------------|
| Rack Size                             | 2U             |      |                |                |
| Form Factor                           | Rack / Tower   |      |                |                |
| Dimensions (WxHxD) (mm <sup>3</sup> ) | 438 x 88 x 410 |      | 438 x 88 x 510 | 438 x 88 x 630 |
| Weight (kg.)                          | 11.6 / 14.1    | 15.5 | 19.5           | 27.5           |









**Environmental**





|  |  |  |  |  |
|--|--|--|--|--|
| Temperature (Operating / Storage)          | 0-40°C (non-condensing) / -20 to +50°C |  |  |  |
| Humidity (Operating / Storage)             | 20-90% RH / 10% to 95% (No condensing) |  |  |  |
| Audible noise at 1.5M from surface of unit | Less than 50 dB                        |  |  |  |
| <b>Certifications</b>                      | UL                                     |  |  |  |



## Troubleshooting

Operation problems can be due to a variety of causes. The first step in solving them is to make sure that all cables are securely attached and seated completely in their sockets.

| Symptom   | Possible Cause   | Action  |
|---|--|---|
| No indication and alarm even though the mains is normal   | The AC input power is not connected well.                  | Check if input power cord firmly connected to the mains.          |
|   | The AC input is connected to the UPS output.               | Plug AC input power cord to AC input correctly.                   |
| The icon  and the warning code  flash on LCD display and alarm is sounding every 2 seconds.   | EPO function is activated.                                 | Set the circuit in closed position to disable EPO function.       |
| The icons of  and  and the warning code  flash on LCD display. Alarm is sounding every 2 seconds.  | Line and neutral conductors of UPS input are reversed.     | Rotate mains power socket by 180° and then connect to UPS system. |
| The icons of  and  and the warning code  flash on LCD display. Alarm is sounding every 2 seconds. | The external or internal battery is incorrectly connected. | Check if all batteries are connected well.                        |
| Fault code is shown as 27 on LCD display and alarm is continuously sounding.  | Battery voltage is too high or the charger is fault.       | Please contact your dealer.                                       |
| Fault code is shown as 28 on LCD display and alarm is continuously sounding.  | Battery voltage is too low or the charger is fault.        | Please contact your dealer.                                       |

| Symptom  | Possible Cause   | Action   |
|--|--|--|
| The icons  and  and the warning code  flash on LCD display. Alarm is sounding every second. | UPS is overload  | Remove excess loads from UPS output.   |
|  | UPS is overloaded. Devices connected to the UPS are fed directly by the electrical network via the Bypass.   | Remove excess loads from UPS output.   |
|  | After repetitive overloads, the UPS is locked in the Bypass mode. Connected devices are fed directly by the mains.   | Remove excess loads from UPS output first. Then shut down the UPS and restart it.                                      |
| Fault code is shown as 49 on LCD display and alarm is continuously sounding.   | UPS is over input current.   | Remove excess loads from UPS output.   |
| Fault code is shown as 43 and the icon  is lighting on LCD display. Alarm is continuously sounding.   | The UPS shut down automatically because of overload at the UPS output.   | Remove excess loads from UPS output and restart it.  |
| Fault code is shown as 14 on LCD display and alarm is continuously sounding.   | The UPS shut down automatically because short circuit occurs on the UPS output.  | Check output wiring and if connected devices are in short circuit status.  |
| Fault code is shown as 01, 02, 03, 11, 12, 13 and 41 on LCD display and alarm is continuously sounding.  | A UPS internal fault has occurred. There are two possible results:<br>1. The load is still supplied, but directly from AC power via bypass.<br>2. The load is no longer supplied by power. | Please contact your dealer.  |
| Battery backup time is shorter than nominal value.   | Batteries are not fully charged  | Charge the batteries for at least 5 hours and then check capacity. If the problem still persists, consult your dealer. |
|  | Batteries defect   | Contact your dealer to replace the battery.  |

---

| <b>Symptom</b>  | <b>Possible Cause</b>   | <b>Action</b>  |
|---|---|--|
| Fault code is shown as 2A on LCD display and alarm is continuously sounding.                | The short circuit occurs on the charger output.                           | Check if battery wiring of connected external pack is in short circuit status. |
| Fault code is shown as 45 on LCD display. At the same time, alarm is continuously sounding. | The charger does not have output and battery voltage is less than 10V/PC. | Please contact your dealer.  |

---

## **ATEN Standard Warranty Policy**

---

### **Limited Hardware Warranty**

ATEN warrants its hardware in the country of purchase against flaws in materials and workmanship for a Warranty Period of two [2] years (warranty period may vary in certain regions/countries) commencing on the date of original purchase. This warranty period includes the [LCD panel of ATEN LCD KVM switches](#). Select products are warranted for an additional year (see [A+ Warranty](#) for further details). Cables and accessories are not covered by the Standard Warranty.

What is covered by the Limited Hardware Warranty

ATEN will provide a repair service, without charge, during the Warranty Period. If a product is defective, ATEN will, at its discretion, have the option to (1) repair said product with new or repaired components, or (2) replace the entire product with an identical product or with a similar product which fulfills the same function as the defective product. Replaced products assume the warranty of the original product for the remaining period or a period of 90 days, whichever is longer. When the products or components are replaced, the replacing articles shall become customer property and the replaced articles shall become the property of ATEN.

To learn more about our warranty policies, please visit our website:

<http://www.aten.com/global/en/legal/policies/warranty-policy/>

Copyright © 2023 ATEN® International Co., Ltd.  
Released: 2023-02-16

ATEN and the ATEN logo are registered trademarks of ATEN International Co., Ltd. All rights reserved. All other brand names and trademarks are the registered property of their respective owners.