

ATEN

CS1182D4

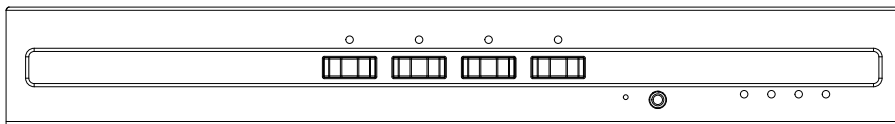
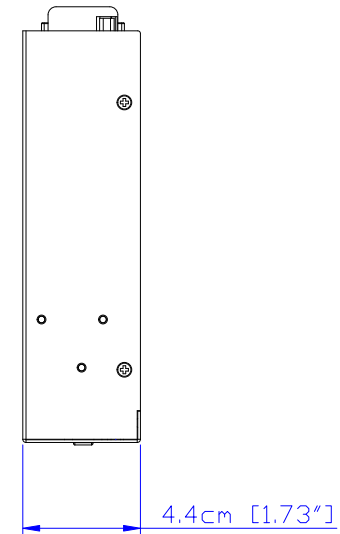
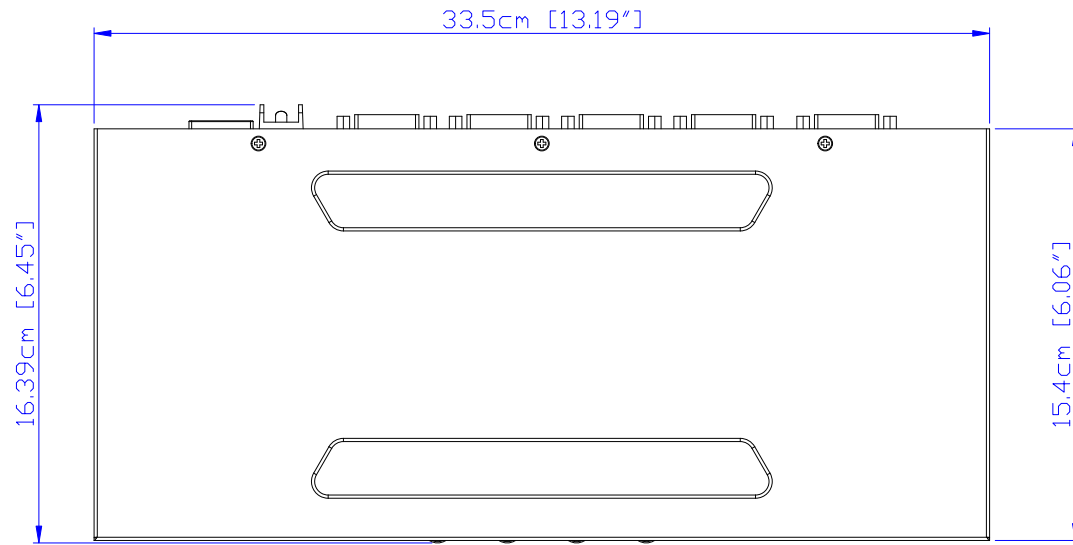
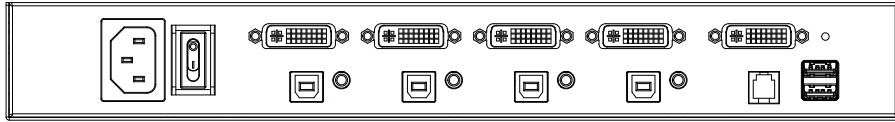

ATEN

CS1184D4

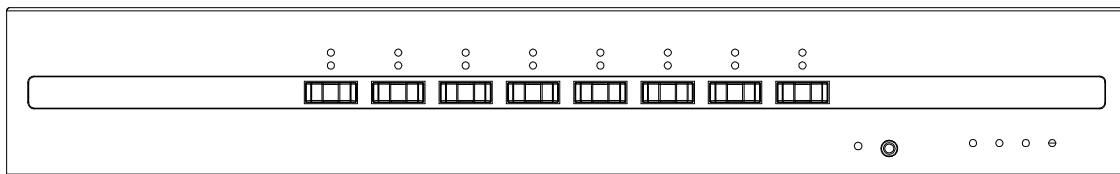
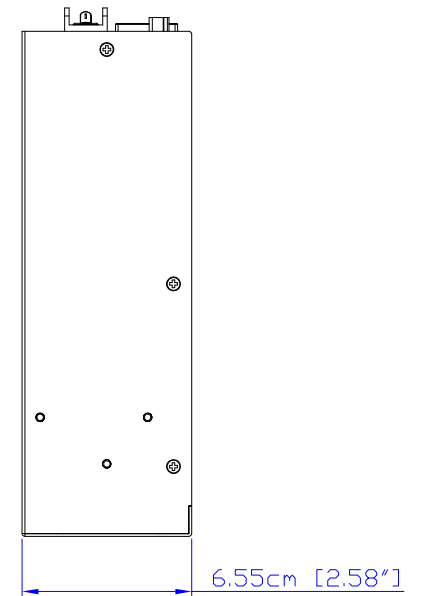
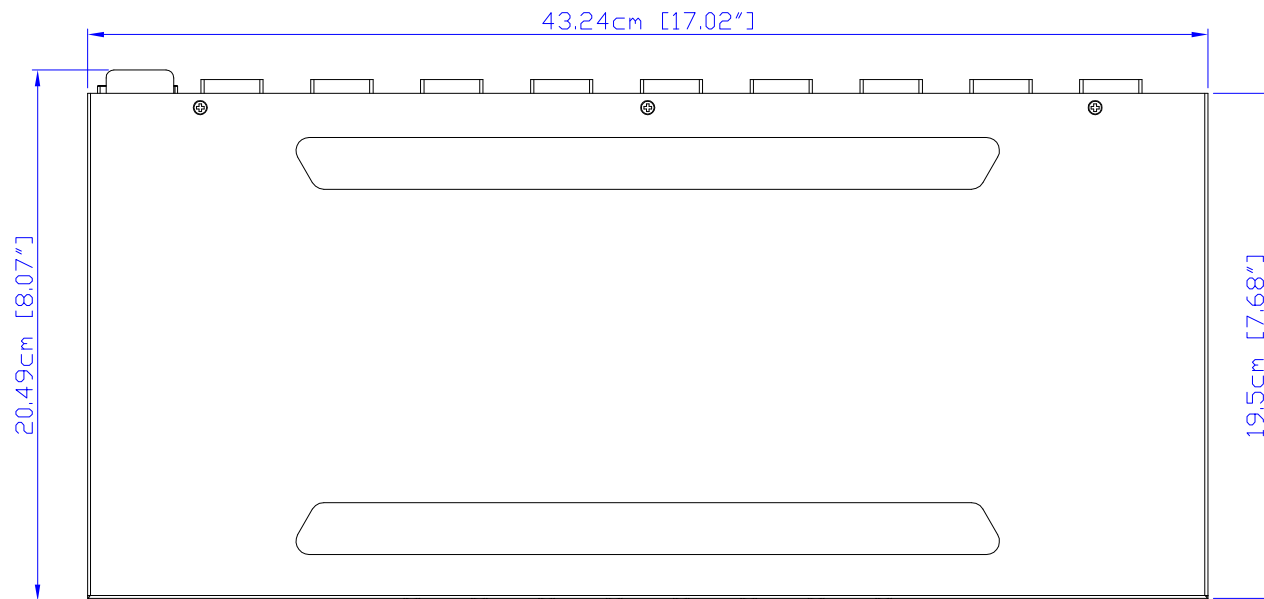
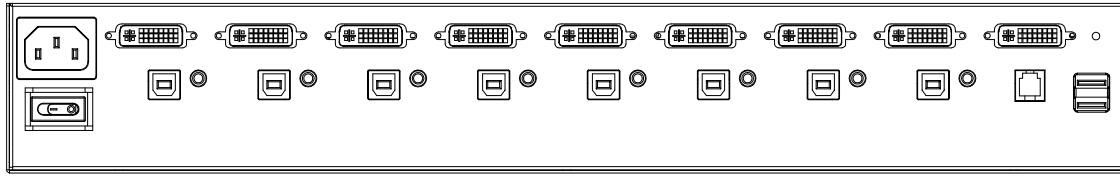

ATEN
CS1188D4

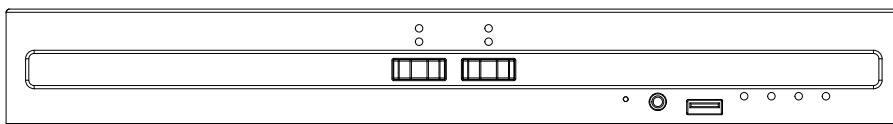
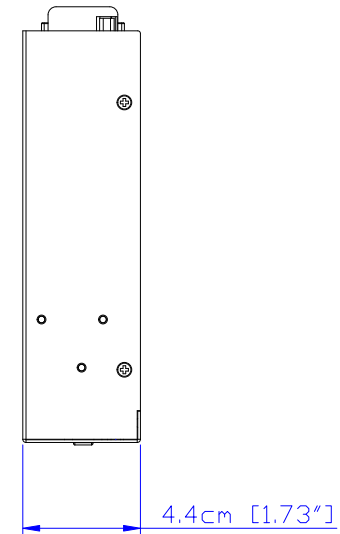
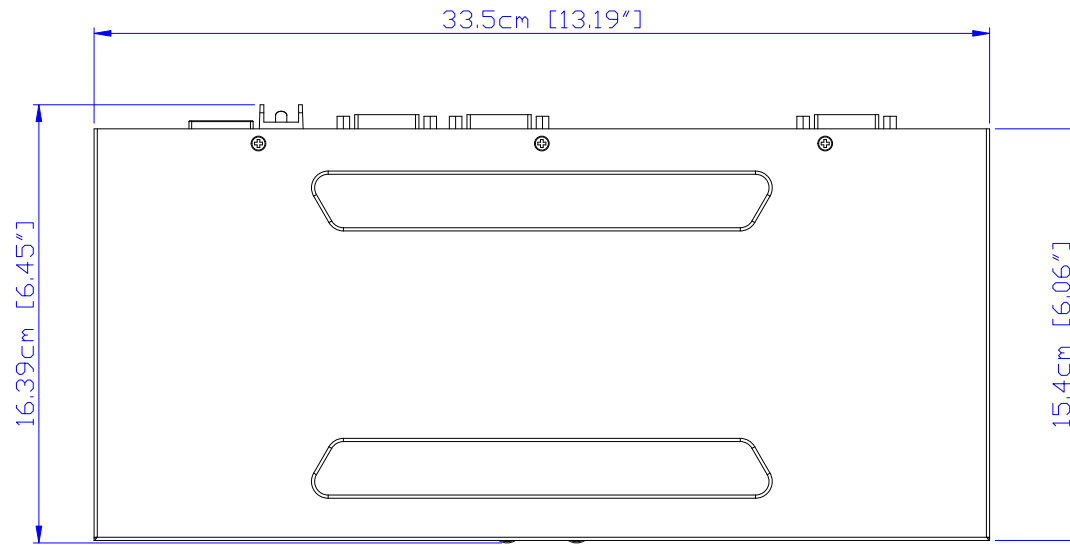
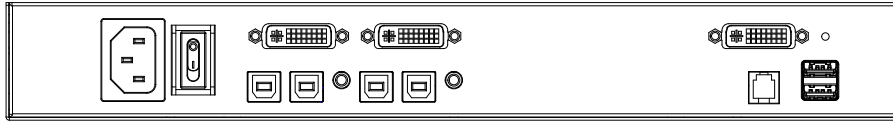

ATEN
CS1182D4C

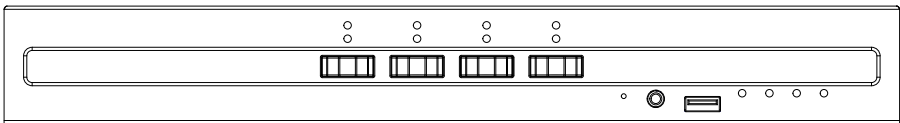
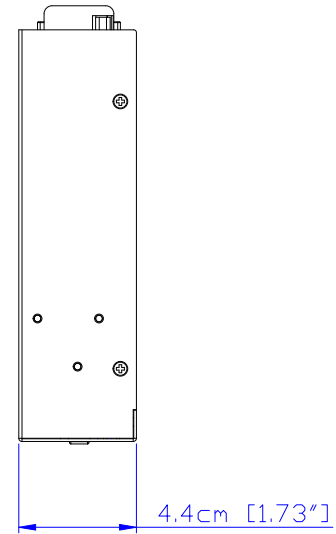
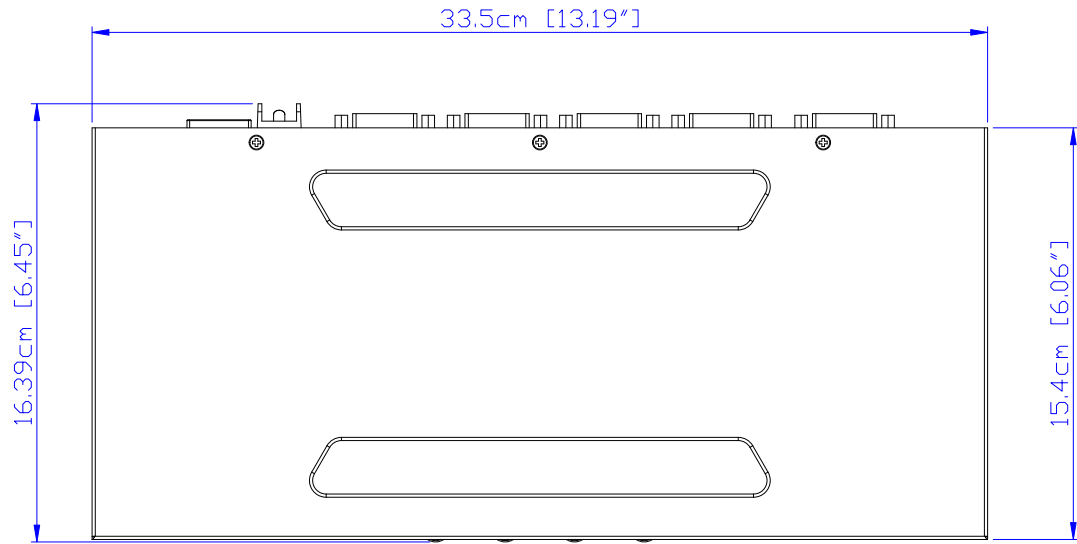
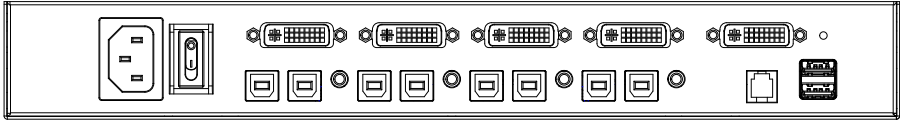

ATEN

CS1184D4C

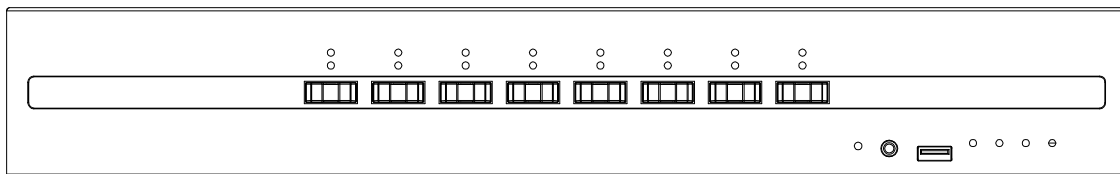
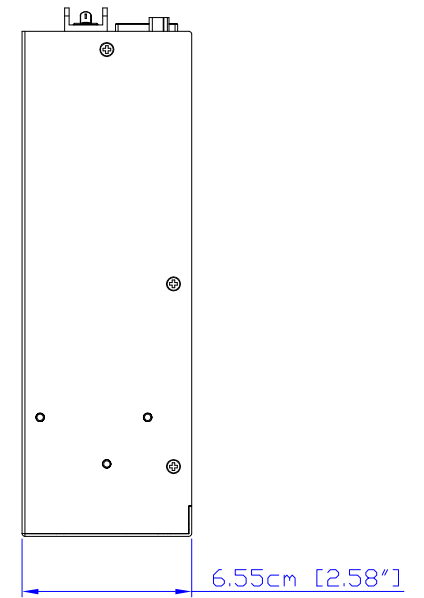
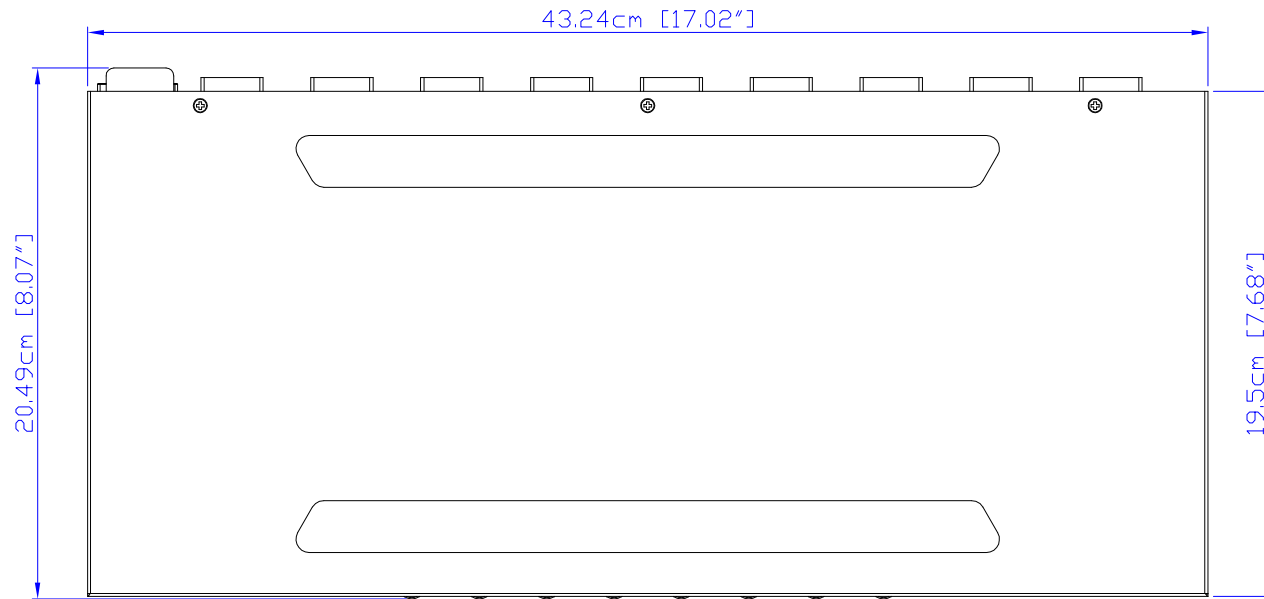
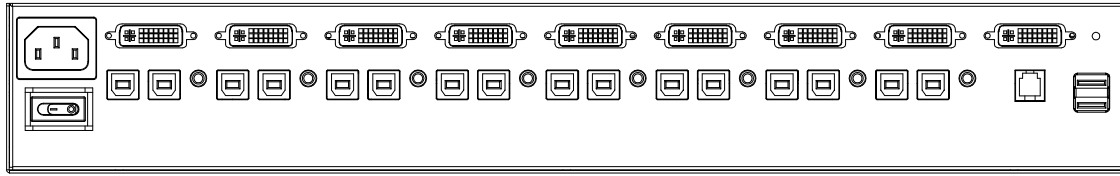

ATEN
CS1188D4C

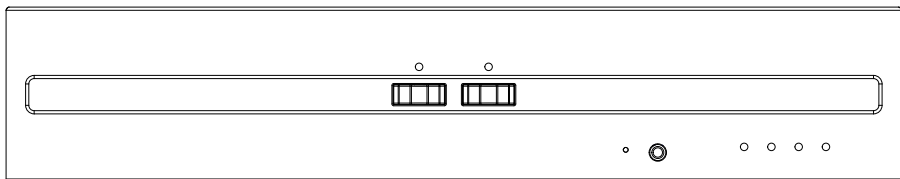
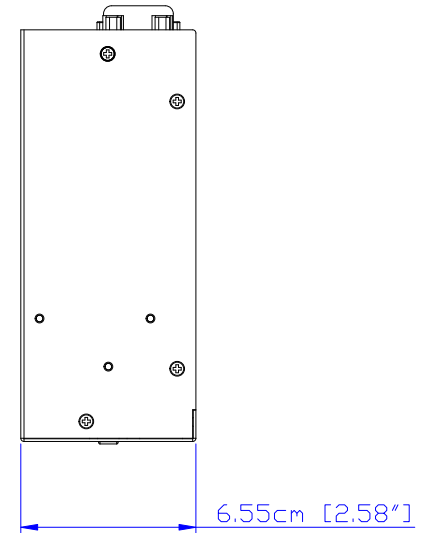
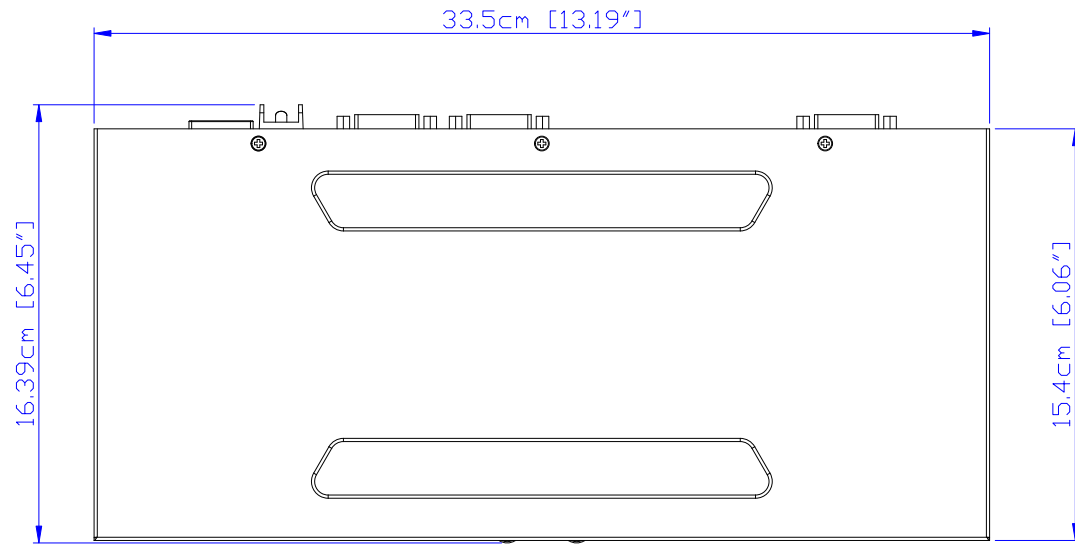
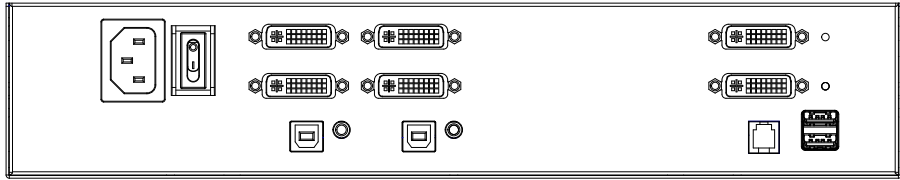

ATEN
CS1142D4

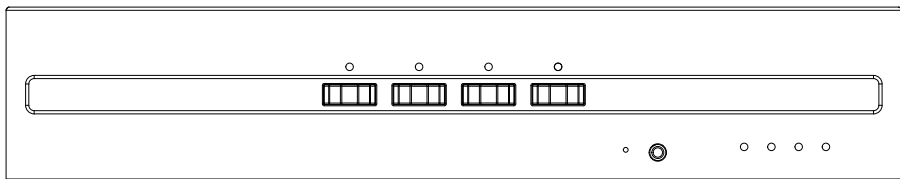
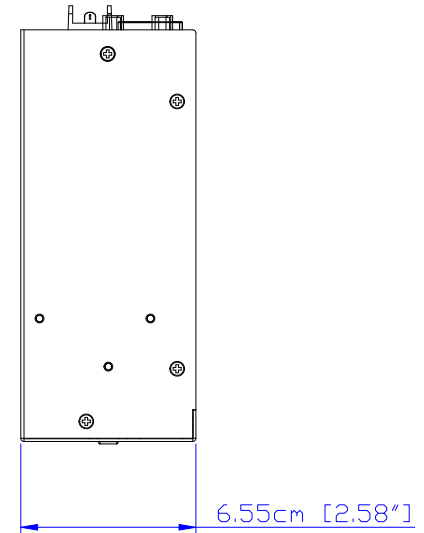
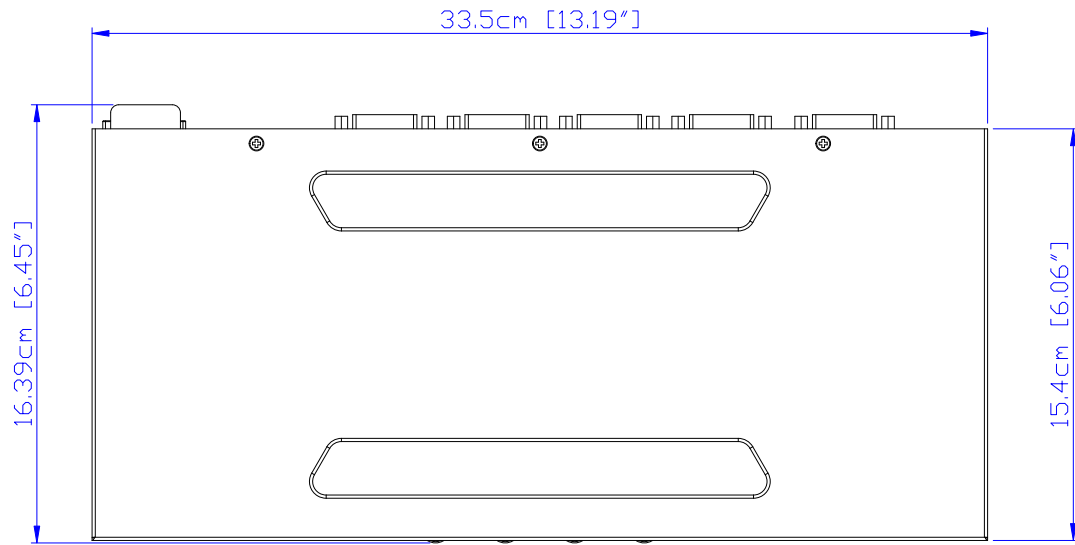
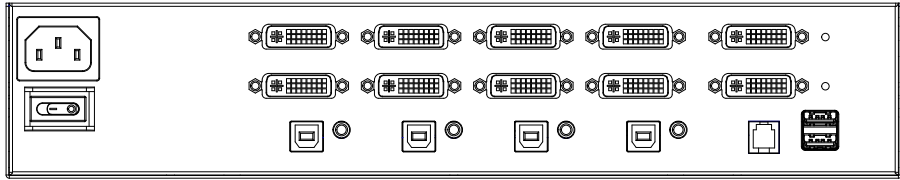

ATEN
CS1144D4

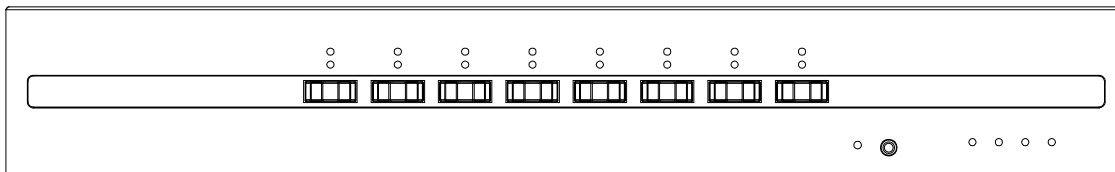
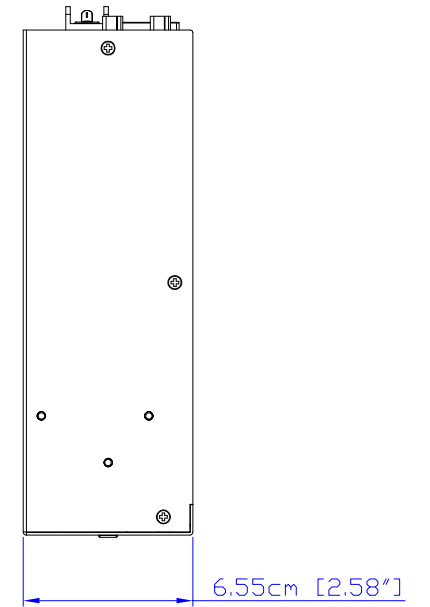
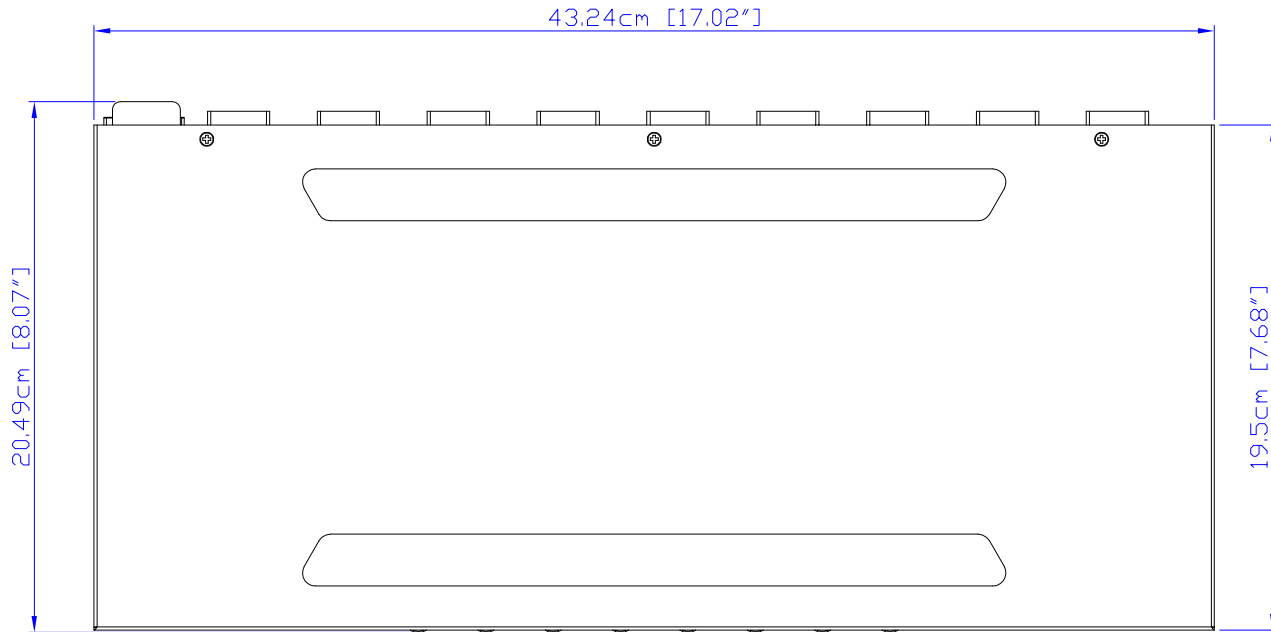
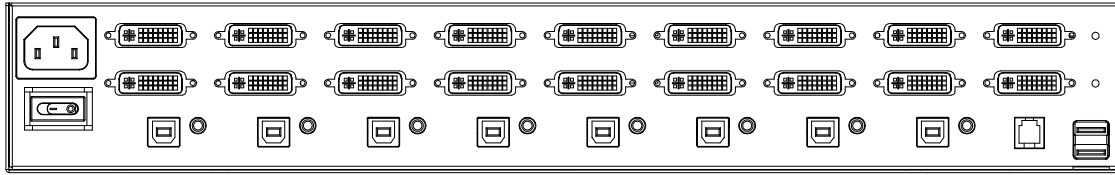

ATEN

CS1148D4

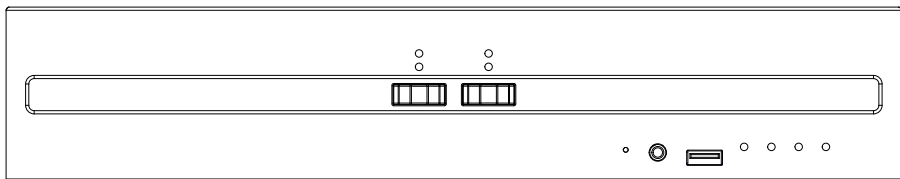
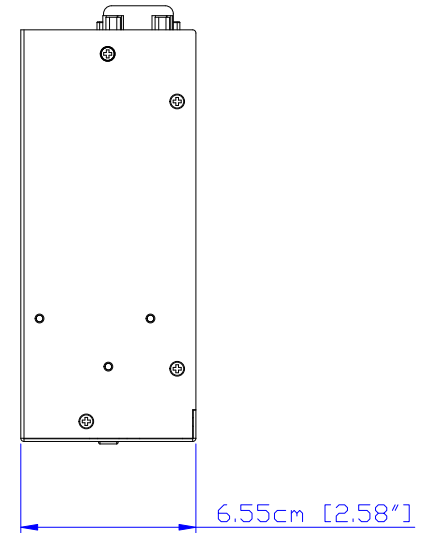
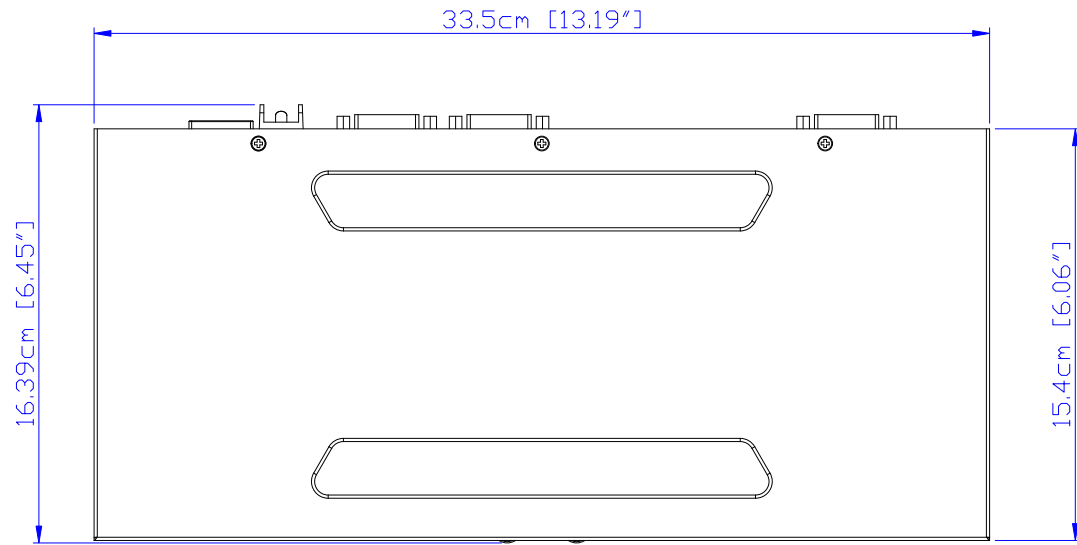
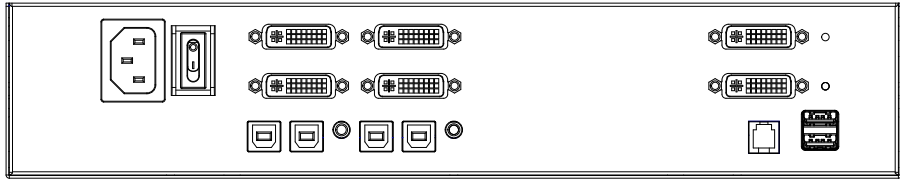

ATEN

CS1142D4C

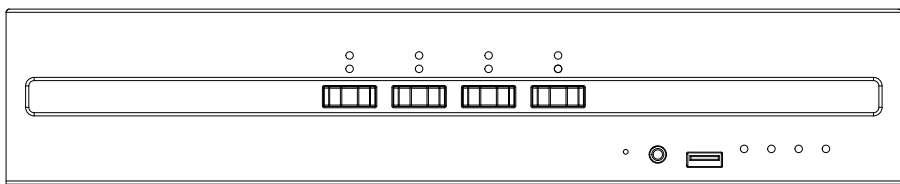
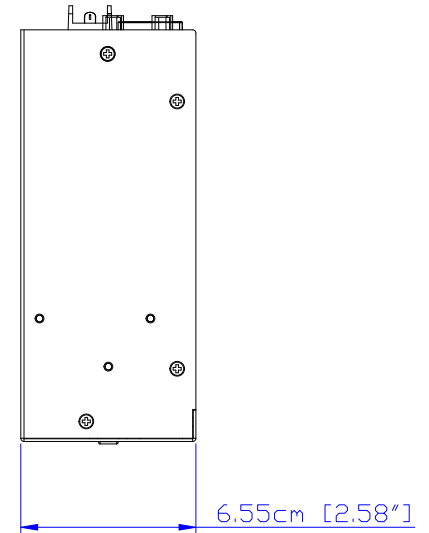
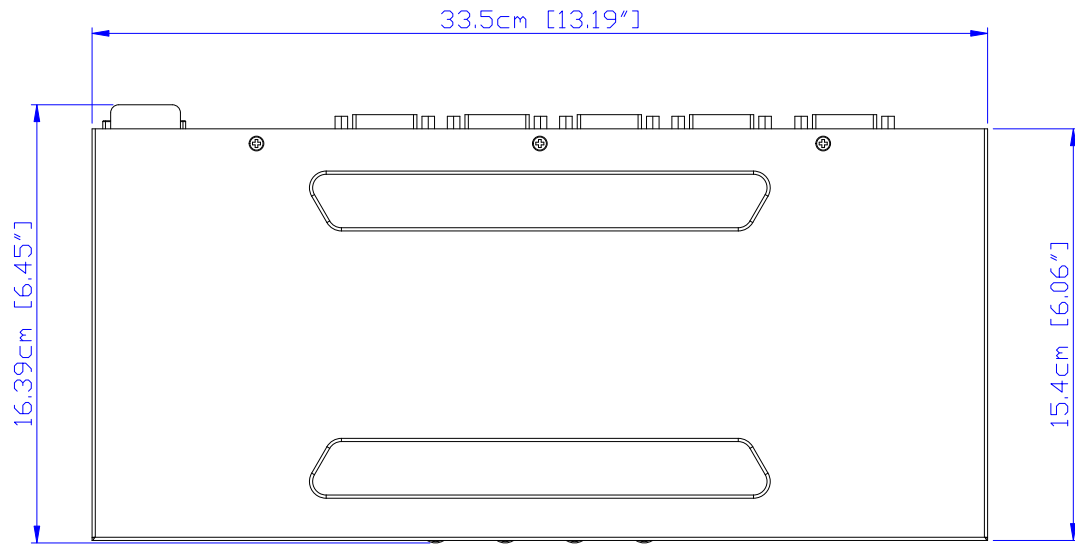
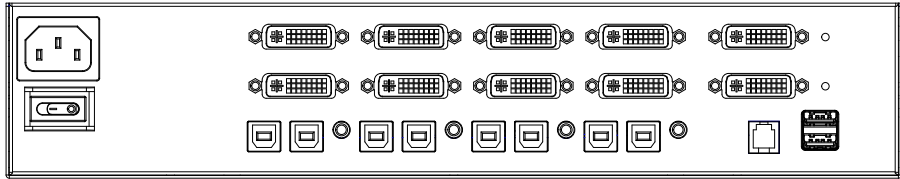

ATEN

CS1144D4C

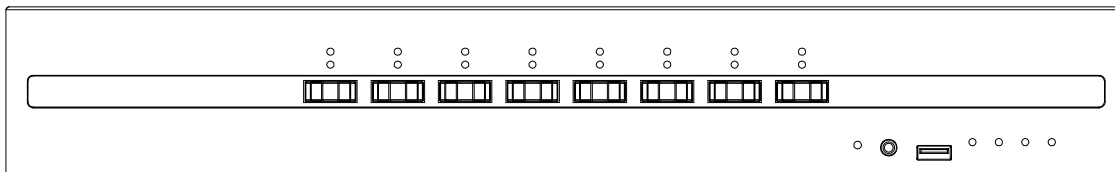
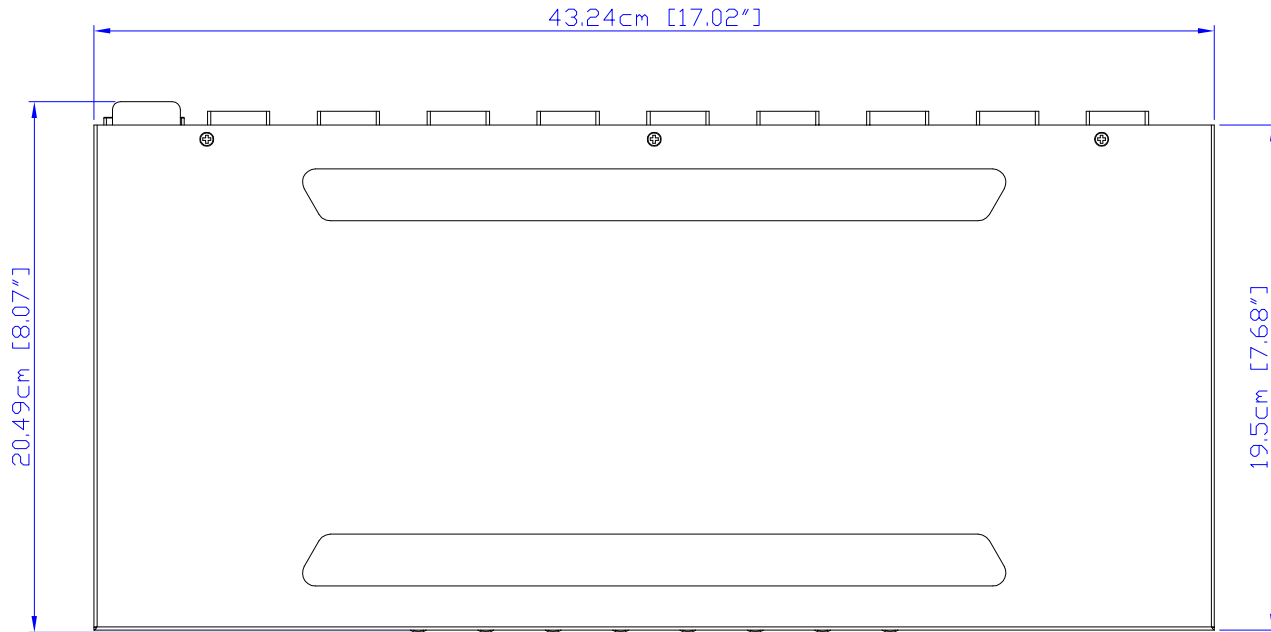
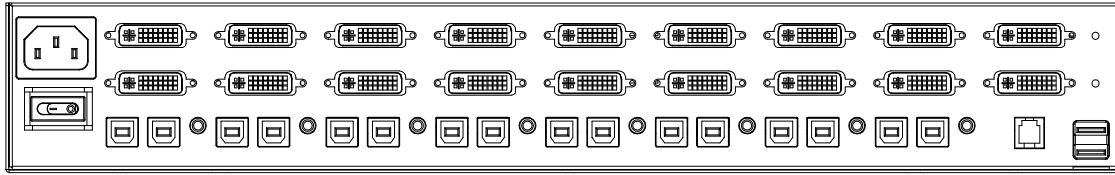

ATEN
CS1148D4C