



8/16-Port USB 3.0 4K DisplayPort KVM Switch CS19208 / CS19216

User Manual



EMC Information

FEDERAL COMMUNICATIONS COMMISSION INTERFERENCE STATEMENT: This equipment has been tested and found to comply with the limits for a Class A digital device, pursuant to Part 15 of the FCC Rules. These limits are designed to provide reasonable protection against harmful interference when the equipment is operated in a commercial environment. This equipment generates, uses, and can radiate radio frequency energy and, if not installed and used in accordance with the instruction manual, may cause harmful interference to radio communications. Operation of this equipment in a residential area is likely to cause harmful interference in which case the user will be required to correct the interference at his own expense.

The device complies with Part 15 of the FCC Rules. Operation is subject to the following two conditions: (1) this device may not cause harmful interference, and (2) this device must accept any interference received, including interference that may cause undesired operation.

FCC Caution: Any changes or modifications not expressly approved by the party responsible for compliance could void the user's authority to operate this equipment.

Warning: Operation of this equipment in a residential environment could cause radio interference.

Achtung: Der Gebrauch dieses Geräts in Wohnumgebung kann Funkstörungen verursachen.

KCC Statement:

유선 제품용 / A 급 기기 (업무용 방송 통신 기기)
이 기기는 업무용 (A 급) 전자파적합기기로서 판매자 또는 사용자는 이
점을 주의하시기 바라며, 가정 외의 지역에서 사용하는 것을 목적으로
합니다.

RoHS

This product is RoHS compliant.



User Information

Online Registration

Be sure to register your product at our online support center:

International	http://eservice.aten.com
---------------	---

Telephone Support

For telephone support, call this number:

International	886-2-8692-6959
China	86-400-810-0-810
Japan	81-3-5615-5811
Korea	82-2-467-6789
North America	1-888-999-ATEN ext 4988 1-949-428-1111

User Notice

All information, documentation, and specifications contained in this manual are subject to change without prior notification by the manufacturer. The manufacturer makes no representations or warranties, either expressed or implied, with respect to the contents hereof and specifically disclaims any warranties as to merchantability or fitness for any particular purpose. Any of the manufacturer's software described in this manual is sold or licensed *as is*. Should the programs prove defective following their purchase, the buyer (and not the manufacturer, its distributor, or its dealer), assumes the entire cost of all necessary servicing, repair and any incidental or consequential damages resulting from any defect in the software.

The manufacturer of this system is not responsible for any radio and/or TV interference caused by unauthorized modifications to this device. It is the responsibility of the user to correct such interference.

The manufacturer is not responsible for any damage incurred in the operation of this system if the correct operational voltage setting was not selected prior to operation. PLEASE VERIFY THAT THE VOLTAGE SETTING IS CORRECT BEFORE USE.

Package Contents

- ◆ 1 CS19208 / CS19216 8/16-Port USB 3.0 4K DisplayPort KVM Switch with Rack Mounting Kit
- ◆ 2 DisplayPort 1.4 Cables
- ◆ 2 USB 3.0 Cables
- ◆ 2 Audio Cables
- ◆ 1 Firmware Upgrade Cable
- ◆ 1 Foot Pad Set (4 pcs)
- ◆ 1 Power Adapter
- ◆ 1 User Instructions*

Check to make sure that all the components are present and that nothing got damaged in shipping. If you encounter a problem, contact your dealer.

Read this manual thoroughly and follow the installation and operation procedures carefully to prevent any damage to the unit, and/or any of the devices connected to it.

Note: Features may have been added to the CS19208 / CS19216 since this manual was published. Please visit our website to download the most up-to-date version.

© Copyright 2020 ATEN® International Co., Ltd.
Manual Date: 2020-10-12

ATEN and the ATEN logo are registered trademarks of ATEN International Co., Ltd. All rights reserved.
All other brand names and trademarks are the registered property of their respective owners.

Contents

EMC Information	ii
RoHS	ii
User Information	iii
Online Registration	iii
Telephone Support	iii
User Notice	iii
Package Contents	iv
Contents	v
About this Manual	ix
Conventions	x
Product Information	x
1. Introduction	
Overview	1
Features	2
Requirements	4
Console	4
Computers	4
Cables	5
Operating Systems	5
Components	6
Front View CS19208	6
Front View CS19216	6
Rear View CS19208	9
Rear View CS19216	9
2. Hardware Setup	
Overview	11
Installation Types	11
Before You Begin	11
Stacking and Rack Mounting	12
Stacking	12
Rack Mounting – Front	13
Rack Mounting – Rear	15
Single Stage Installation	17
Single Stage Installation Diagram	18
Two Stage Cascade	19
Two Stage Installation Diagram	21
Multi-display Installation	22
Cable Connections for Multi-display Installation	22
Multi-display Installation Diagram	23
Grouping Ports into “Vertical” Channels	24
Channels Diagram	24

3. Basic Operation

Hot Plugging	25
Hot Plugging KVM Ports	25
Hot Plugging Console Ports	25
Port Selection	26
Manual Port Switching	26
Port ID Numbering	26
Powering Off and Restarting	27

4. OSD Operation

OSD Overview	29
Manufacturing Number	29
OSD Login	29
OSD Hotkey	30
OSD Main Screen	30
OSD Main Screen Headings	31
OSD Navigation	31
OSD Functions	32
F1: Go To	33
F2: List	34
F3: Set	35
F4: Admin	37
F5: SKP	41
F6: BRC	42
F7: SCAN	43
F8: Logout	44

5. Hotkey Operation

Hotkey Port Control	45
Hotkey Setting Mode	46
Invoking HSM	46
Select the Active Port	47
Auto Scan Mode	48
Invoking Auto Scan:	48
Skip Mode	49
Keyboard / Mouse Reset	50
Hotkey Beeper Control	50
HSM Hotkey Control	50
OSD Hotkey Control	51
Port OS Control	51
Restore Default Values	52
Video DynaSync	52
EDID Mode	53
Mouse Emulation Control	53
HSM Summary Table	54

6. Keyboard Emulation

Mac Keyboard	57
Sun Keyboard	58

7. RS-232 Operation

Overview	59
Setup	59
Hardware Connection	59
RS-232 Pin Assignments	60
Console Login - HyperTerminal	61
RS-232 Commands	62
Verification	62
Login	63
Logout	64
Open / Close RS-232 Link	65
Set Baud Rate	66
Switch Port	67
Hotkey Setting	68
OSD Hotkey	69
USB Reset	70
Restore Default Settings	71
Firmware Upgrade	72
KVM Status	73
EDID Mode see VS482B	74
Broadcast Mode	75

8. The Firmware Management Utility

Introduction	77
Downloading the Firmware Upgrade Package	77
Preparation	78
Starting the Upgrade	79
Upgrade Succeeded	82
Upgrade Failed	82
Firmware Upgrade Recovery	83
OSD Configuration Backup/Restore	84
Backup	84
Restore	85

Appendix

Safety Instructions	87
General	87
Rack Mounting	89
Technical Support	90
International	90
North America	90

CS19208 / CS19216 Connection Tables	91
Specifications	93
Administrator Login Failure	94
Factory Default Hotkeys and Settings	95
Limited Warranty	96

About this Manual

This User Manual is provided to help you get the most from your CS19208 / CS19216 system. It covers all aspects of installation, configuration and operation. An overview of the information found in the manual is provided below.

Chapter 1, Introduction, introduces you to the CS19208 / CS19216 system. Its purpose, features and benefits are presented, and its front and back panel components are described.

Chapter 2, Hardware Setup, describes how to set up your installation. The necessary steps for a basic single stage hookup, three-stage cascade, and multi-display installation are provided.

Chapter 3, Basic Operation, explains the fundamental concepts involved in operating the CS19208 / CS19216.

Chapter 4, OSD Operation, provides a complete description of the CS19208 / CS19216's OSD (On Screen Display), and how to work with it.

Chapter 5, Hotkey Operation, details all of the concepts and procedures involved in the Hotkey operation of your CS19208 / CS19216 installation.

Chapter 6, Keyboard Emulation, provides tables that list the PC to Mac and PC to Sun keyboard emulation mappings.

Chapter 7, RS-232 Operation, provides details on the functions and RS-232 commands that you can use to control the CS19208 / CS19216 using a serial controller.

Chapter 8, The Firmware Management Utility, explains how to use this utility to upgrade the CS19208 / CS19216's firmware with the latest available versions and perform an OSD configuration backup/restore.

An Appendix, provides specifications and other technical information regarding the CS19208 / CS19216.

Conventions

This manual uses the following conventions:

- Monospaced Indicates text that you should key in.
- [] Indicates keys you should press. For example, [Enter] means to press the **Enter** key. If keys need to be chorded, they appear together in the same bracket with a plus sign between them: [Ctrl+Alt].
1. Numbered lists represent procedures with sequential steps.
- ◆ Bullet lists provide information, but do not involve sequential steps.
- Indicates selecting the option (on a menu or dialog box, for example), that comes next. For example, Start → Run means to open the *Start* menu, and then select *Run*.
-  Indicates critical information.

Product Information

For information about all ATEN products and how they can help you connect without limits, visit ATEN on the Web or contact an ATEN Authorized Reseller. Visit ATEN on the Web for a list of locations and telephone numbers:

International	http://www.aten.com
North America	http://www.aten-usa.com

Chapter 1

Introduction

Overview

The ATEN CS19208/CS19216 8/16-Port USB 3.0 4K DisplayPort KVM Switch can effectively access and control up to 8/16 DisplayPort computers from a single USB keyboard, USB mouse, and monitor console. With its dual interface console, users can choose between DisplayPort/HDMI video output supporting high video quality up to 4K DCI (4096 x 2160 @ 60Hz), presenting crystal-clear visuals.

To meet the needs of easy expansion and flexibility, the CS19208/CS19216 can be cascaded to two levels to control up to 128/256 computers from a single console. Furthermore, the CS19208/CS19216 supports multi-display function by stacking up to eight CS19208/CS19216 units to compare and analyze information on 8 monitors at most, which substantially streamlines the working environment.

With two patented ATEN technology – Video DynaSync™ and EDID Expert™, the CS19208/CS19216 can optimize display resolution, accelerate switching between ports and power up smoothly while eliminating boot-up display problems.

Besides, the CS19208/CS19216 comes with a built-in USB 3.1 Gen 1 hub delivering data transfer rates up to 5 Gbps, allowing users to speed up operations and share USB peripherals instantly. For user-friendly port selection methods, the CS19208/CS19216 offers pushbuttons, hotkeys, RS-232 commands, and OSD with newly-designed UI, bringing effortless and intuitive operations.

To eliminate security concern, a two-level password authorization is available to enhance security protection for accessing and controlling computers. Consolidating these advantageous functionalities, the CS19208/CS19216 is ideal for server room/computer room management applied in industries with requirements for high-quality images and multitasking, such as Enterprise, Government, Production, Telecom, Finance, Medical Healthcare, Industrial Automation, etc.

Note:

- ◆ The CS19208 / CS19216 offers two types of installation – 1) standalone/ cascade; and 2) multi-display – that require different cabling setups. Therefore, the functions of both types are not available in one installation.

- ◆ For PC compatible computers. Mac and Sun computers must use the USB cable connections (see *Cables*, page 5).
-

Features

- ◆ One USB console controls up to eight (CS19208) or sixteen (CS19216) DisplayPort interface computers and two additional USB 3.0 peripheral devices
- ◆ Cascadable to two levels – controls up to 128/256 computers (CS19208/CS19216)¹
- ◆ Multi-Display feature – stack up to eight CS19208/CS19216 units and display video from up to 8 monitors (dual display / triple display / quad display / multi-display)
- ◆ Video DynaSync™ – an exclusive ATEN technology that eliminates boot-up display problems and optimizes the resolution when switching among different sources
- ◆ EDID Expert™ – selects optimum EDID mode for smooth power-up and highest quality display
- ◆ Supports a DisplayPort or HDMI video output – allows you to choose an appropriate video output and deploy console with flexibility
- ◆ Superior video quality – up to 4K DCI (4096 x 2160 @ 60Hz)
- ◆ Built-in 2-port USB 3.1 Gen 1 hub with SuperSpeed 5 Gbps data transfer rates
- ◆ Audio enabled – full bass response provides a rich experience for 2.1 channel stereo sound
- ◆ Supports HD audio²
- ◆ Computer selection via pushbuttons, hotkeys, OSD, and RS-232 commands
- ◆ Independent switching of KVM and USB peripheral focus³
- ◆ Two-level (administrator/user) password authorization for enhanced security protection
- ◆ Broadcast mode – operations can be simultaneously performed on all selected computers, such as software installation and upgrading, system-wide shutdown, etc.

- ◆ Auto Scan Mode for monitoring all computers
- ◆ Console mouse port emulation/bypass feature supports most mouse drivers and multifunction mice
- ◆ Multilingual keyboard mapping – supports English (US), English (UK), German (GER.), German (SWISS), French, Hungarian, Italian, Japanese, Korean, Russian, Spanish, Swedish, Traditional Chinese, and Simplified Chinese
- ◆ Mac/Sun keyboard support and emulation⁴
- ◆ Supports hot-plugging
- ◆ DisplayPort 1.2 compliant; HDCP 2.2 compliant
- ◆ Multiplatform support – Windows, Linux, Mac, and Sun
- ◆ Firmware upgradable
- ◆ Supports multimedia, wireless keyboards and mouse

Note: 1. Cascading between CS19208 and CS19216 is available.

2. HD audio through HDMI and DisplayPort channel cannot be switched independently.
 3. Independent switching is only supported under mouse emulation mode.
 4. PC keyboard combinations emulate Mac/Sun keyboards; Mac/Sun keyboards work only with their own computers.
-

Requirements

Console

- ◆ An HDMI compatible monitor capable of the highest possible resolution that you will be using on any computer in the installation
- ◆ A DisplayPort compatible monitor capable of the highest possible resolution that you will be using on any computer in the installation

Note: For multi-display installations, multiple monitors are required. See *Multi-display Installation*, page 22, for details.

- ◆ A USB mouse
- ◆ A USB keyboard
- ◆ Speakers (optional)

Computers

The following equipment must be available on each computer:

- ◆ A DisplayPort card or DisplayPort port

Note:

- ◆ The quality of the display is affected by the quality of the DisplayPort display card. For best results, we recommend you purchase a high quality product.
 - ◆ For multi-display installations, the computers require multiple DisplayPort cards. See *Multi-display Installation Diagram*, page 23, for details.
-

- ◆ A Type A USB port
- ◆ Audio ports (optional)

Cables

- ◆ Only custom USB DisplayPort KVM cable sets, which are specifically designed to work with this switch, may be used to link to the computers. Two cable sets are provided with this package.

Note: The quality of the display is affected by the quality and length of the cables. If you need additional cable sets, please contact your dealer to purchase the appropriate ones for your switch.

- ◆ For multi-display installations, standard USB Type A to USB Type B cables and standard DisplayPort cables are also required.

Note: The CS19208 / CS19216 supports speaker ports only. Do not connect the microphone connector from the KVM cable sets.

Operating Systems

OS		Version
Windows		Windows Server 2008, 2012, 2016, 2019 / Windows 7 SP1 / Windows 8 / Windows 8.1 / Windows 10
Linux	CentOS	7 and higher
	OpenSUSE Leap 15.1 Snapshot8	10.26 and higher
	Ubuntu	16.0.4 and higher
	NeoKylin	v7.0
SUN	Sun Solaris	11.3 and higher
Mac		10.6 and higher

Note:

- ◆ Supports Linux Kernel 2.6 and higher.
 - ◆ The CS19208 / CS19216 has a built-in USB3.1 hub, and does not support PCs or operating systems that do not support USB3.1.
-

Components

Front View CS19208

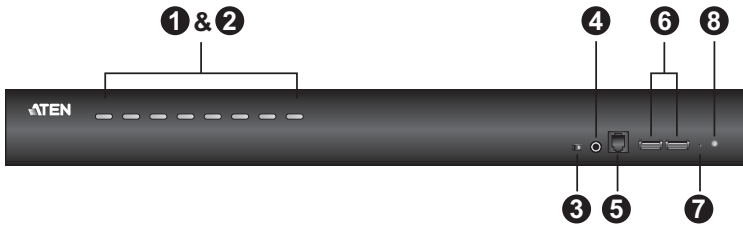

Front View CS19216

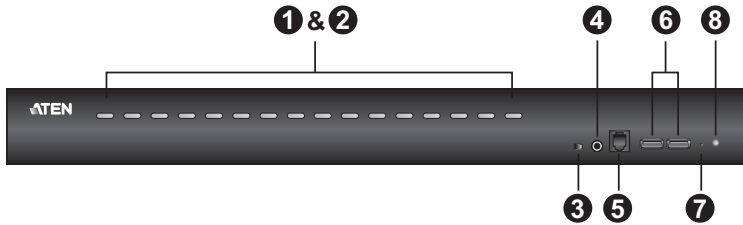

No.	Component	Description
1	Port Selection Pushbuttons	<p>For manual port selection (see <i>Port Selection</i>, page 26, also):</p> <ul style="list-style-type: none"> ◆ Press a port selection pushbutton for less than two seconds to bring the KVM, USB hub, and audio focus to the computer attached to its corresponding port. ◆ Press a pushbutton for longer than two seconds to bring the KVM and audio focus* to the computer attached to its corresponding port. ◆ Press pushbuttons 1 and 2 simultaneously for 2 seconds to perform a keyboard and mouse reset start. See <i>Keyboard / Mouse Reset</i>, page 50, for details. ◆ Press pushbuttons 7 and 8 simultaneously for 2 seconds to start Auto Scan Mode*. See <i>Auto Scan Mode</i>, page 48, also <p>Note: Enable mouse emulation for independent switching (see page 40).</p>
2	Port LEDs	<p>The Port LEDs are built into the Port Selection Switches. The left ones are the KVM Port LEDs; the right ones are the USB LEDs:</p> <p>KVM</p> <ul style="list-style-type: none"> ◆ Lights DIM ORANGE to indicate that the computer attached to the corresponding port is up and running (On Line). ◆ Flashes to indicate that Firmware Upgrade mode is in effect. ◆ Changes to BRIGHT ORANGE to indicate that the computer attached to its corresponding port is the one that has the KVM focus (Selected). ◆ Flashes to indicate that the computer attached to its corresponding port is being accessed under Auto Scan mode. <p>USB</p> <ul style="list-style-type: none"> ◆ Lights GREEN to indicate that the computer attached to its corresponding port is the one that has access to the USB peripherals.
3	Firmware Upgrade Recovery Switch	<p>During normal operation and while performing a firmware upgrade, this switch should be in the NORMAL position. If a firmware upgrade operation does not complete successfully, this switch is used to perform a firmware upgrade recovery. See <i>Firmware Upgrade Recovery</i>, page 83, for details.</p>
4	Audio Jack	<p>The cables from your main speakers plug in here.</p> <p>Note: The speakers plugged in here have priority over those in the rear panel.</p>
5	Firmware Upgrade Port	<p>The firmware upgrade cable that transfers the firmware upgrade data from the administrator's computer to the CS19208 / CS19216 plugs into this RJ-11 connector.</p>

No.	Component	Description
6	USB 3.1 Gen 1 Peripheral Hub Section	<p>USB 3.1 peripherals (printers, scanners, etc.) can plug into this port (this may require an extra power adapter).</p> <p>Note: The USB 3.1 hub cannot be accessed through the switch by computers on the second level of a cascaded installation.</p>
7	Reset Button	<p>Pressing this switch performs a system reset. When the system is reset, the switch beeps, and the port LEDs flash in succession until the reset is complete. After the reset is complete you can login again.</p> <p>Note: This switch is recessed and must be pushed with a small object, such as the end of a paper clip or a ballpoint pen.</p>
8	Power LED	<p>Lights to indicate that the switch is powered up and ready to operate.</p>

Rear View CS19208

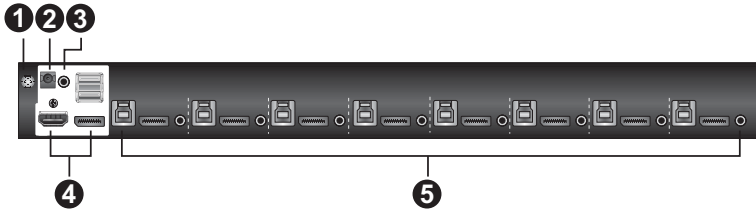

Rear View CS19216

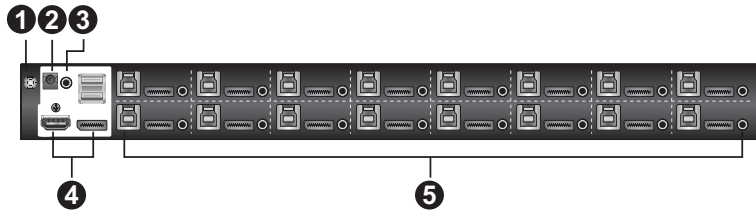

No.	Component	Description
1	Grounding Terminal	The grounding wire used to ground the switch attaches here.
2	Power Jack	The power adapter cable plugs in here.
3	Audio Jack	The cables from your main speakers plug in here. Note: The speakers plugged into the front panel have priority over those plugged here.
4	Console Port Section	The cables from your console DisplayPort monitor, HDMI monitor, USB keyboard, USB mouse, and speakers plug in here. Each connector is marked with an appropriate icon to indicate itself.
5	KVM Port Sections	The cables that link the switch to your computers plug in here. Each KVM port section is comprised of a speaker jack, a USB type B socket, and DisplayPort connector.

This Page Intentionally Left Blank

Chapter 2

Hardware Setup

Overview

For convenience and flexibility that allows mixing multiple platforms, the CS19208 / CS19216 design utilizes custom USB DisplayPort KVM cables that serve as intermediaries between the switch and the connected computers (refer to the installation diagram on page 18).

A separate custom USB DisplayPort KVM cable is required for each computer connection. The custom KVM cables are listed under *Cables*, on page 5. Consult your dealer to find out which custom KVM cables best fit your needs.

Installation Types

The CS19208 / CS19216 offers two types of installation – 1) standalone/cascade; and 2) multi-display – that require different cabling setups. Therefore, the functions of both types are not available in one installation. See the following sections in this chapter for details about the different cabling requirements.

Before You Begin



1. Important safety information regarding the placement of this device is provided on page 87. Please review it before proceeding.
2. To prevent damage to your installation from power surges or static electricity. It is important that all connected devices are properly grounded.
3. Make sure that power to all devices that you will be installing has been turned off. You must unplug the power cords of any computers that have the Keyboard Power On function.

Stacking and Rack Mounting

The CS19208 / CS19216 can be stacked on the desktop or rack mounted at the front or rear of the rack. The following sections take you through the procedures for each method.

Note:

- ◆ Allow at least 5.1 cm on each side for adequate ventilation and 12.7 cm at the rear for power cord and cable clearance.
 - ◆ The standard rack mounting kit does not include screws or cage nuts. If you need additional screws or cage nuts, contact your rack dealer.
-

Stacking

The CS19208 / CS19216 can be placed on any level surface that can safely support its weight and the weight of the attached cables. Make sure that the surface is clean and free of any materials that can block the exhaust vents or otherwise interfere with normal operation of the switch.

To place the CS19208 / CS19216, or to stack units if you are cascading them, remove the backing material from the bottom of the rubber feet that came with this package, and stick them onto the bottom panel at the corners, as shown in the diagram, below:

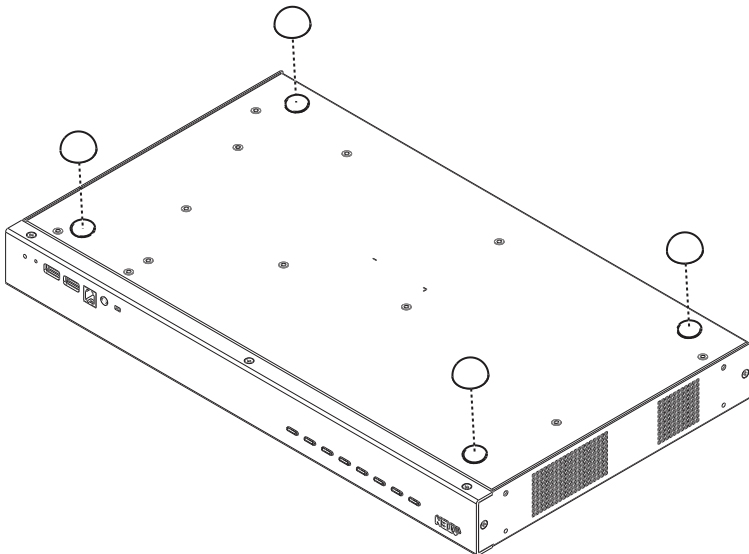

Rack Mounting – Front

1. Remove the screws, one each from the left and right sides near the front of the unit.

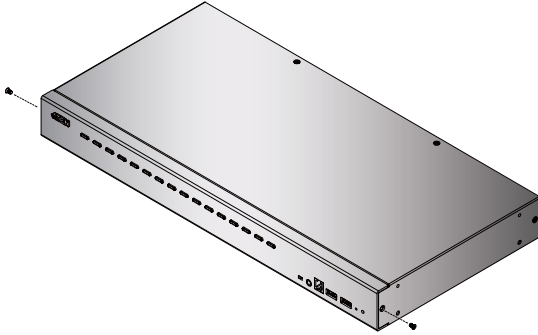

2. Use the M3 x 6 Phillips hex head screws supplied with the rack mounting kit to screw the rack mounting brackets into the sides near the front of the unit.

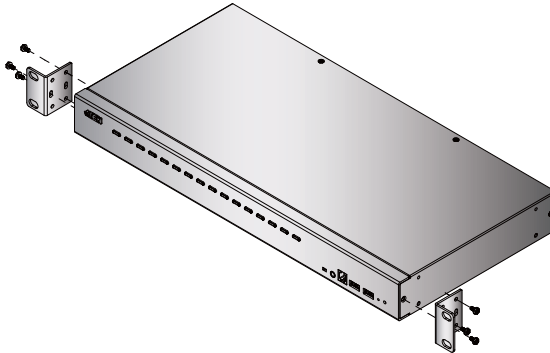

3. Place the KVM switch in the rack. Position it so that the holes in the mounting brackets line up with the holes in the rack. Secure the mounting brackets to the front of the rack.

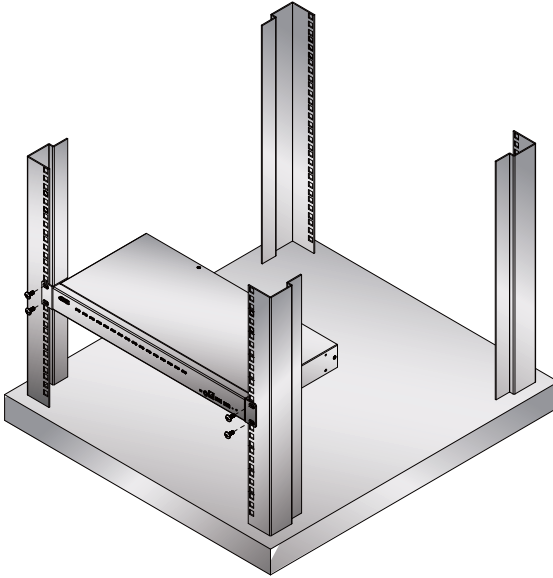

Rack Mounting – Rear

1. Remove the screws, one each from the left and right sides of the switch near the rear of the unit.

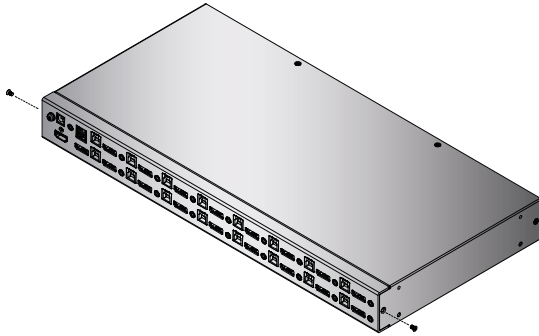

2. Use the M3 x 6 Phillips hex head screws supplied with the rack mounting kit to screw the rack mounting brackets into the sides near the rear of the unit.

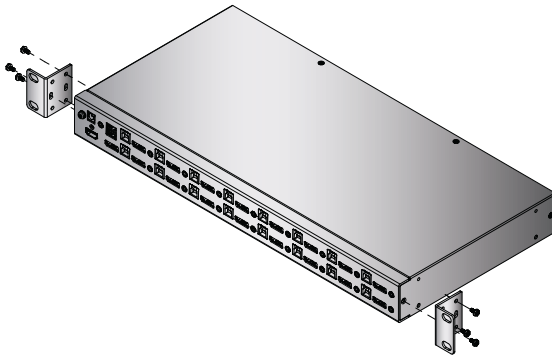

3. Place the KVM switch in the rack. Position it so that the holes in the mounting brackets line up with the holes in the rack. Secure the mounting brackets to the rear of the rack.

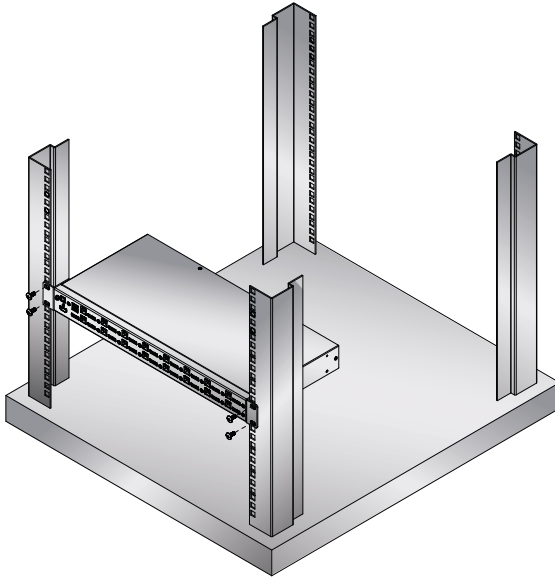

Single Stage Installation

To set up your single stage CS19208 / CS19216 installation, refer to the installation diagram on page 18 (the numbers in the diagrams correspond to the steps, below), and do the following:

1. Ground the CS19208 / CS19216 by connecting one end of a grounding wire to the Grounding Terminal and the other end to a suitable grounded object.

Note: Do not omit this step. Proper grounding helps to prevent damage to the unit from power surges or static electricity.

2. Plug your USB keyboard and USB mouse into the USB console ports from the Console Ports Section located on the unit's rear panel.
3. Plug your DisplayPort and/or HDMI monitor(s) into the DisplayPort and/or HDMI console port(s) from the Console Ports Section located on the unit's rear panel and power on the monitor(s).

Note: The CS19208 / CS19216 displays the same source content on both the DisplayPort and HDMI monitors when DisplayPort and HDMI console ports are plugged in simultaneously.

4. Plug your speakers into the Audio Jacks located on the unit's front and rear panel. The speakers plugged into the front panel have priority over those plugged into the rear panel.
5. Use the provided cable sets (DisplayPort cable, USB 3.0 cable, and audio cable) with this package. Plug the DisplayPort connector into any available DisplayPort port in the KVM Ports Section of the switch (CPU 1, CPU 2, etc.), and then plug the USB 3.0 cable and audio cable into their corresponding ports.

Note:

- ◆ Verify that all the connectors are in the same KVM Ports Section (all in CPU 1, all in CPU 2).
 - ◆ The CS19208 / CS19216 only supports speaker ports. Do not connect a KVM cable's microphone connector to the speaker ports.
-

- At the other end of the cables from step 5, plug the DisplayPort cable, USB 3.0 cable, and audio cables into their respective ports on the computer. Repeat steps 5, and 6 for other PC systems you are installing.
- (Optional) Plug your USB peripherals into the USB Type-A ports in the USB 3.1 Gen1 Peripheral Hub Section located on the unit's front panel.
- Plug the power adapter that came with your switch into an AC power source, then plug power adapter cable into the switch's Power Jack. Now the CS19208 / CS19216 is turned on.
- Power on the computers.

Note: Make sure the computers and devices that the CS19208 / CS19216 connects to are also properly grounded.

Single Stage Installation Diagram

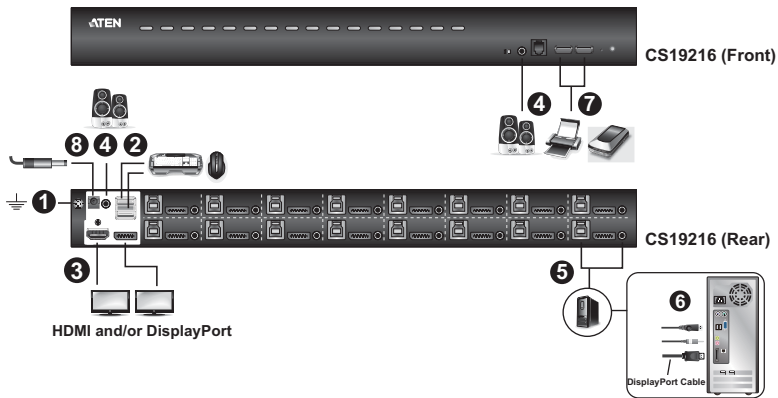

Two Stage Cascade

To control even more computers, additional CS19208 / CS19216 units can be cascaded from the KVM ports of the First Stage unit. The cascaded CS19208 / CS19216s that connect back to the First Stage unit are considered Second Stage units. As many as 128 (CS19208) or 256 (CS19216) computers can be controlled in a complete two stage installation. A table showing the relation between the number of computers and the number of units needed to control them is provided on page 91.

To set up a two stage installation, refer to the *Two Stage Installation* diagram on the next page as you do the following:

1. Make sure that power to all the devices you will be connecting up, including all preexisting devices on the installation, have been turned off.
2. Use the provided cable sets (DisplayPort cable, USB 3.0 cable, and audio cable) with this package to connect any available KVM Port on the First Stage unit to the Console ports of the Second Stage unit.

Note: Plug the USB Type-A connector into the lower USB (keyboard) port in the Console section (they are both marked with a similar icon to remind you of the correct USB port).

3. Using another provided cable sets (DisplayPort cable, USB 3.0 cable, and audio cable) with this package, plug the DisplayPort connector into any available DisplayPort port in the KVM Ports Section of the second stage switch, then plug the accompanying USB Type-B, and audio cable into their corresponding USB, and audio jack.

Note:

- ♦ Verify that all the connectors are in the same KVM Ports Section (all in CPU 1, all in CPU 2, etc.), and that each socket is marked with an appropriate icon to indicate itself.
 - ♦ The CS19208 / CS19216 only supports speaker ports. Do not connect a KVM cable's microphone connector to the speaker ports.
-
4. At the other end of the cables from step 3, plug the DisplayPort cable, USB 3.0 cable, and audio cables into their respective ports on the computer.
 5. Repeat steps 3 and 4 for any other PC systems you are installing.

6. For each Second Stage unit, plug the power adapter cable into its Power Jack, then plug the power adapter into an AC source.
7. Plug the First Stage unit's power adapter cable into its Power Jack, then plug the power adapter into an AC source.
8. Power on the computers.

Note:

- ◆ The Power On sequence requires that all Second Stage units be powered on first. After they are all on, the First Stage units must be powered on next. Only after all the switches have been powered on in this sequence, can the computers be powered on.
 - ◆ The USB 3.1 hub cannot be accessed through the switch by computers on the second level of a cascaded installation.
 - ◆ Make sure the computers and devices that the CS19208 / CS19216 connects to are also properly grounded.
-

Two Stage Installation Diagram

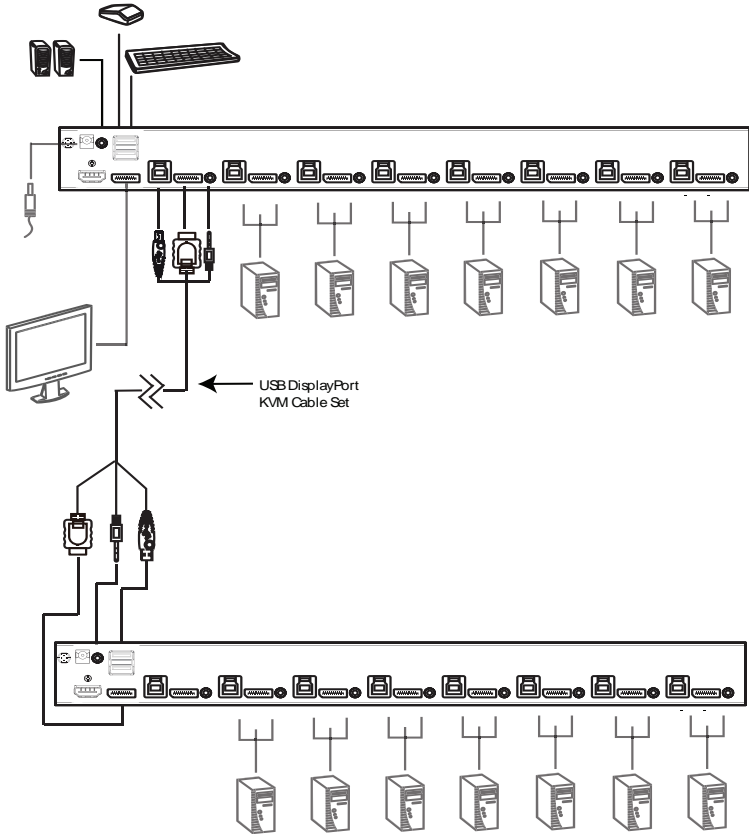

Multi-display Installation

The CS19208 / CS19216's multi-display feature allows you to stack two, three, four, or up to 8 units in a dual/triple/quad-display/multi-display installation to control up to seven (CS19208) or fifteen (CS19216) computers at once. This installation requires slightly different cabling than the standard cascade and offers an extra level of switching flexibility for multiple-monitor installations where each computer is fitted with multiple video cards.

Note: In a Multi-display installation, the CS19208 can only be connected to CS19208 units, and the CS19216 can only be connected to CS19216 units.

Cable Connections for Multi-display Installation

To set up your multi-display installation, refer to the installation diagram on the next page (the numbers in the diagrams correspond to the steps, below), and do the following:

1. Use a standard USB Type A-to-USB Type B cable to connect the Port 8 USB Type B port on the first stage unit to the USB Type A port in the Console section of the second switch.

Note:

- ◆ Port 8 is reserved to connect the units in a multi-display installation, so up to seven (CS19208) or fifteen (CS19216) computers can be attached, using KVM ports 1–7 (CS19208) or ports 1–7/9–16 (CS19216).
 - ◆ Plug the USB Type-A connector into the lower USB (keyboard) Port in the Console Port Section (both USB Ports are marked with a similar icon to remind you of the correct USB port).
-

2. Use DisplayPort cables to connect the DisplayPort KVM port on the second CS19208 / CS19216 unit to the second video-in port on the computers.

Note: Only DisplayPort video cables are necessary – the other ports in the KVM section are not required in this installation.

3. Connect a display to the console section of the second switch.
 4. Repeat steps 1–3 for any additional units, up to a total of 8 switches.
-

5. Connect the cables for the first switch. See *Single Stage Installation*, page 17 for full details. All video, audio and peripheral devices must be connected to the first switch.
6. Power up the CS19208 / CS19216 units, starting with the first switch, and then power on the computers.

Note: Make sure the computers and devices that the CS19208 / CS19216 connects to are also properly grounded.

Multi-display Installation Diagram

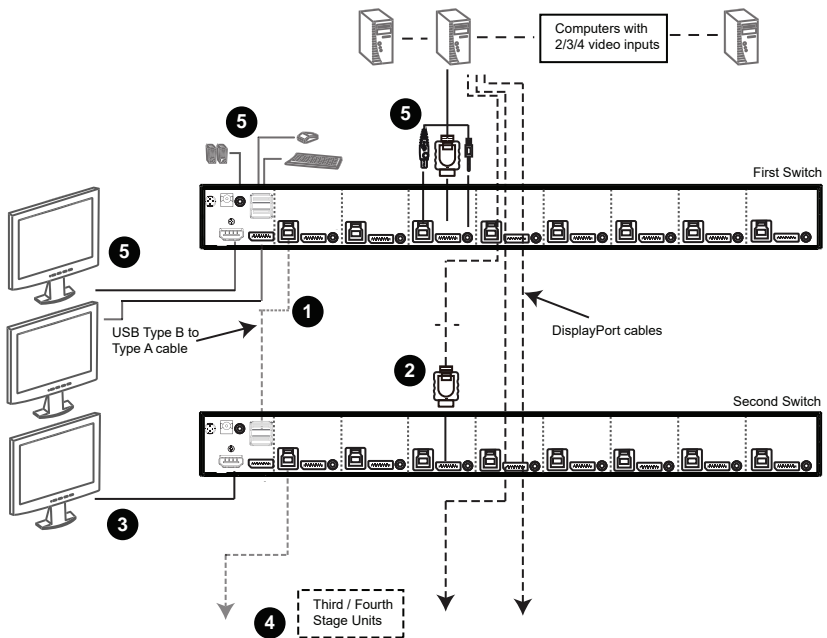

Grouping Ports into “Vertical” Channels

Once the cables have been connected and multi-display mode has been selected in the OSD, the CS19208 / CS19216 auto-detects the channels and displaying modes. Users can then assign them a channel number as the port name (the channels are represented by the vertical columns in the diagram below). So, all the Port 1s become Channel 1, all the Port 2s become Channel 2, ... , and all the Port 7s become Channel 7. The ports will all be switched at the same time, channel by channel.

Depending on the number of stages in your stack, a CS19208 / CS19216 installation offers dual display (two stages), triple display (three stages), quad display (four stages) or multi-display (up to 8 stages) scenarios. For reference purposes, the example shows a four-stage installation with quad display functionality.

Note: Only one DisplayPort video signal can be displayed at a time, depending on the configuration of the CS19208 / CS19216 unit on the first switch.

Channels Diagram

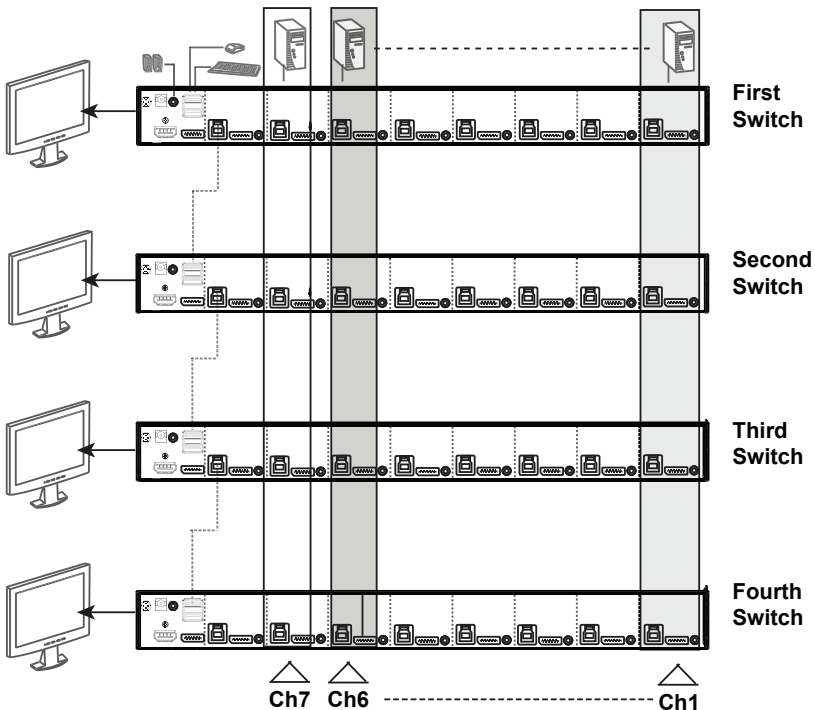

Chapter 3

Basic Operation

Hot Plugging

The CS19208 / CS19216 supports *hot plugging* – components can be removed and added back into the installation by unplugging their cables from the ports without the need to shut the unit down. In order for hot plugging to work properly, the procedures described below must be followed:

Hot Plugging KVM Ports

In order for the OSD menus to correspond to KVM port changes, you must manually reconfigure the OSD to reflect the new port information. See the *F3 SET* (page 35) and *F4 ADM* (page 37), functions for details.

Note: If the computer's operating system does not support hot plugging, this function may not work properly.

Hot Plugging Console Ports

The keyboard, monitor, and mouse can all be hot plugged. When hot plugging the mouse:

- ◆ You may unplug and replug the mouse (to reset the mouse, for example), as long as you use the same mouse.
- ◆ If you plug in a different mouse, all the computers on the installation must be shut down for 10 seconds, then restarted following the power up sequence described under Steps 6, 7, and 8 under *Two Stage Cascade*, page 19

Note: If, after hot plugging there is no response to keyboard and/or mouse input, perform a *Keyboard and Mouse Reset* by simultaneously pressing the 1 and 2 (CS19208 / CS19216) front panel pushbuttons.

Port Selection

The CS19208 / CS19216 provides four port selection methods to access the computers on the installation: Manual, an OSD (on-screen display) menu system, Hotkeys, and RS-232 commands.

- ♦ For OSD (on-screen display), see Chapter 4 *OSD Operation*, page 29 for more information.
- ♦ For Hotkeys operation, see Chapter 5 *Hotkey Operation*, page 45 for more information.
- ♦ For RS-23 commands, see Chapter 7 *RS-232 Operation*, page 59 for more information.

Manual Port Switching

Use the front panel pushbutton switches to manually switch to a port.

Port ID Numbering

Each port on a CS19208 / CS19216 installation is assigned a unique *Port ID*. You can directly access any computer on any level of the installation by specifying the Port ID that the computer is connected to – either with the OSD (see *OSD Operation*, page 29), or with the Hotkey port selection method (see *Hotkey Operation*, page 45).

- ♦ A computer attached to a primary unit has a two digit Port ID (from 01–08 for the CS19208, or 01–16 for the CS19216) that corresponds to the KVM port number that it is connected to.
- ♦ A computer attached to a secondary unit has a four digit Port ID.

The first two digits represent the KVM port number on the primary unit and the second two digits represent the KVM port number on the secondary unit that the computer is connected to. For example, a Port ID of 02–08 would refer to a computer that is connected to KVM port 8 of a secondary unit that links back to KVM port 2 of the primary unit.

Powering Off and Restarting

If it becomes necessary to power off a CS19208 / CS19216, do the following before restarting it:

1. Unplug the CS19208 / CS19216 from its power source.
2. Shut down all the computers that are attached to it.

Note: Unplug the power cords of any computers that have the *Keyboard Power On* function. Otherwise, the CS19208 / CS19216 will still receive power from the computers.

3. Wait 10 seconds, then plug the CS19208 / CS19216 back in.
4. Power on the computers.

Note: If there are stations cascaded down from the primary CS19208 / CS19216, all the cascaded stations and the computers attached to them must be shut down as well.

This Page Intentionally Left Blank

Chapter 4

OSD Operation

OSD Overview

The on-screen display (OSD) is a mouse and keyboard enabled, menu driven method to handle computer control and switching operations. All procedures start from the OSD main screen.

Manufacturing Number

The “MFG Number” (Manufacturing Number) is an internal serial number used by ATEN’s factory and technical support staff to identify products. This number does not affect products’ warranty. If your product requires after-sales services, you may provide the MFG Number to ATEN’s sales or technical support staff to identify the product and model number.

OSD Login

The OSD incorporates a two level (administrator / user) password system. Before the OSD main screen displays, a login screen appears requiring a password. If this is the first time that the OSD is used, or if the password function has not been set, simply press **[Enter]**. The OSD main screen displays in administrator mode. In this mode, you have administrator privileges, with access to all administrator and user functions, and can set up operations (including password authorization) as you like. If the password function has been set, you must provide an appropriate administrator/user password in order to access the OSD.

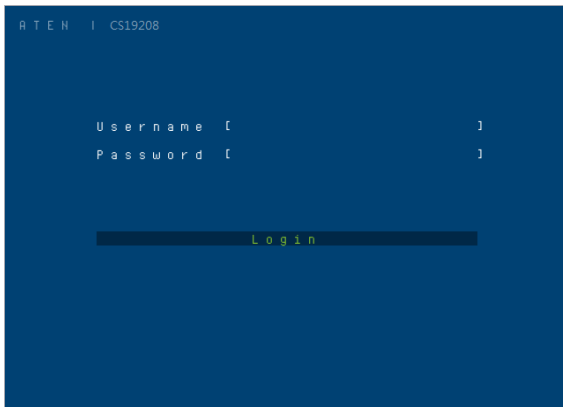

OSD Hotkey

You can display the OSD on the console monitor while also viewing the display of any port on the CS19208 / CS19216 by pressing the [**Scroll Lock**] key twice.

Note: You can optionally change the OSD hotkey to the Ctrl key, in which case you would press [**Ctrl**] twice (see *OSD HOTKEY*, page 35). With this method, you must press the same [Ctrl] key.

OSD Main Screen

When you invoke the OSD, a screen similar to the one below appears:

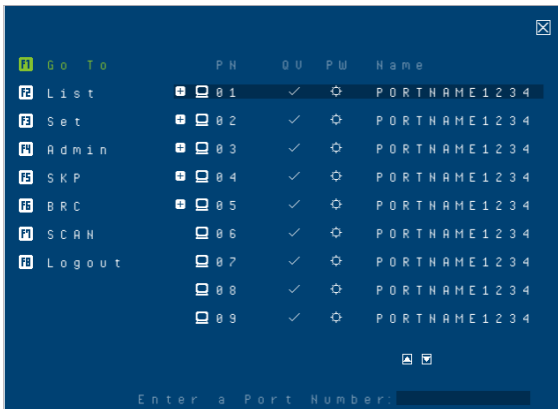

Note:



- ◆ The diagram depicts the administrator's main screen. The user main screen does not show the **F4** and **F6** functions, since these are reserved for the administrator and can't be accessed by users.
- ◆ The OSD always starts in list view, with the highlight bar at the same position it was in the last time it was closed.
- ◆ Only the ports that have been set accessible by the administrator for the current logged in user are visible (see *SET ACCESSIBLE PORTS*, page 38).
- ◆ Enable Mouse Emulation to operate the OSD using mouse. When the Mouse Emulation is disabled, you can only operate the OSD using keyboard.
 - a) To enable the Mouse Emulation via OSD, see *Mouse Emulation*, page 40.

- b) To enable the Mouse Emulation via hotkeys, see *Mouse Emulation Control*, page 53.
- ◆ If the port list is collapsed, click on a switch number, or move the highlight bar to it then press the Enter key to expand the list. Similarly, to collapse a switch's port list, click on the switch number, or move the highlight bar to it then press the right Enter key to collapse the list.

OSD Main Screen Headings

PN	This column lists the port ID numbers for all the KVM ports on the installation. The simplest method to access a particular computer is move the highlight bar to it, then press Enter .
QV	If a port has selected for quick view scanning (see <i>SET QUICK VIEW PORTS</i> , page 39), a check mark (✓) displays in this column.
PW	The computers that are powered on and are online have a sun symbol in this column 
NAME	If a port has been given a name (see <i>EDIT PORT NAMES</i> , page 39), its name appears in this column.

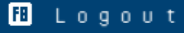
OSD Navigation

- ◆ To dismiss the menu, and deactivate OSD, click  at the upper right corner of the OSD window; or press **[Esc]**.
- ◆ To log out, click  at the left of the main screen, or press **[F8]**.
- ◆ To move up or down through the list one screen at a time, click the up and down arrow symbols ( ), or use the [Pg Up] and [Pg Dn] keys. If there are more list entries than what can appear on the main screen, the screen will scroll.
- ◆ To activate a port, click it, or move the highlight bar to it then press **[Enter]**.
- ◆ After executing any action, you automatically go back to the menu one level above.

OSD Functions

OSD functions are used to configure and control the OSD. For example, you can rapidly switch to any port, scan selected ports, limit the list you wish to view, designate a port as a quick view port, create or edit a port name, or make OSD setting adjustments.

To access an OSD function:

1. Either click on the function key field on the left of the main screen, or press a function key on the keyboard.
2. In the submenus that appear make your choice either by clicking it, or moving the highlight bar to it, then pressing **[Enter]**.
3. Press **[Esc]** to return to the previous menu level.

F1: Go To

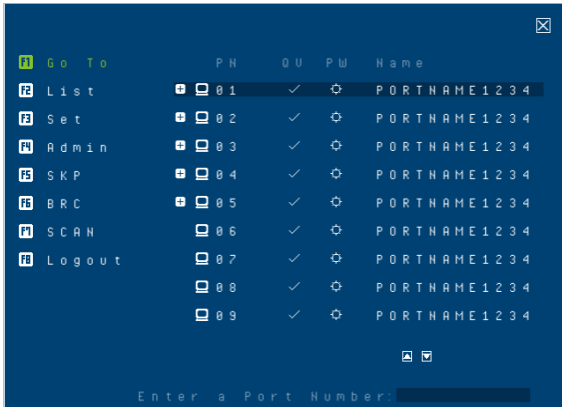

Clicking **F1 G O T O** or pressing **[F1]** activates the Go To function. Go To allows you to switch directly to a port by keying in the port's ID. Enable mouse emulation for independent switching (see page 40), for this function to work.

- ◆ To use the search method, key in the *Port ID*; then press **[Enter]** to switch KVM, Audio and USB focus; or **[Spacebar]** to switch KVM and Audio only.

F2: List

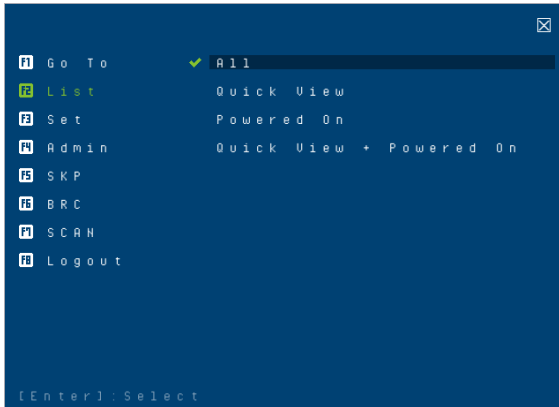

Clicking **F2 List** or pressing **F2** activates the List function. This function lets you broaden or narrow the scope of which ports the OSD displays on the main screen. The submenu choices and their meanings are given in the table below.

Choice	Meaning
ALL	Lists all of the ports on the installation that have been set accessible by the administrator for the current logged in user.
Quick View	Lists only the ports that have been selected as quick view ports (see <i>SET QUICK VIEW PORTS</i> , page 39).
Powered On	Lists only the ports that have their attached computers powered on.
Quick View + Powered On	Lists only the ports that have been selected as quick view ports (see <i>SET QUICK VIEW PORTS</i> , page 39), and that have their attached computers powered on.

Move the highlight bar to the choice you want, then press **[Enter]**. A check mark (✓) appears before the choice to indicate that it is the currently selected one.

F3: Set

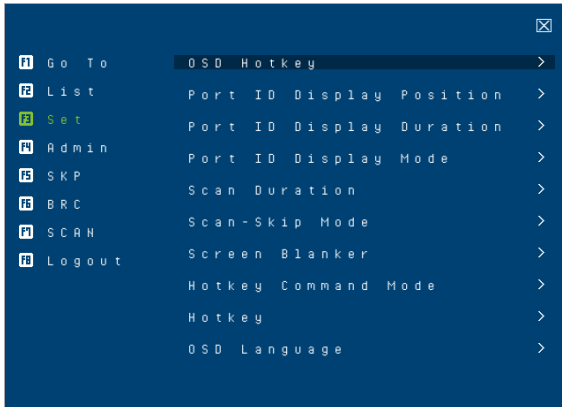

Clicking **F3 Set** or pressing **F3** activates the Set function. This function allows the administrator and each user to set up his own working environment. A separate profile for each is stored by the OSD and is activated according to the username that was provided during login.

To change a setting:

1. Click it; or move the highlight bar to it, then press **[Enter]**.
2. After you select an item, a submenu with further choices appears. To make a selection, either click it; or move the highlight bar to it, then press **[Enter]**. A check mark (✓) appears before the selected choice to indicate which one it is. The settings are explained in the following table:

Setting	Function
OSD Hotkey	<p>Selects which hotkey activates the OSD function:</p> <p>[Scroll Lock] [Scroll Lock] or [Ctrl] [Ctrl].</p> <p>Since the [Ctrl] key combination may conflict with programs running on the computers, the default is the [Scroll Lock] combination.</p>
Port ID Display Position	<p>Allows each user to customize the position where the port ID appears on the screen. The default is the upper left corner, but users can choose to have it appear anywhere on the screen.</p> <p>Use the mouse or the arrow keys plus Pg Up, Pg Dn, Home, and End (on the numeric keypad with Num Lock off). Arrow keys move the position one space at a time. Pg Up and Pg Dn brings position to the top or bottom. Home and End brings the position to the rightmost and leftmost of the screen. To position the port ID display, then single-click or press [Enter] to lock the position and return to the Set submenu.</p>

Port ID Display Duration	Determines how long a port ID displays on the monitor after a port change has taken place. The choices are: 3 Seconds (default) and Always Off .
Port ID Display Mode	Selects how the port ID is displayed: the port number plus the port name (Port Number + Port Name) (default); the port number alone (Port Number); or the port name alone (Port Name).
Scan Duration	Determines how long the focus dwells on each port as it cycles through the selected ports in Auto Scan mode (see <i>F7 SCAN</i> , page 43). Key in a value from 1–255 seconds, then press [Enter] . Default is 5 seconds; a setting of 0 disables the SCAN function. Note: We recommend to set the scan duration to 10 seconds.
Scan-Skip Mode	Selects which computers will be accessed under skip mode (see <i>F5: SKP</i> , page 41), and Auto Scan mode (see <i>F7: SCAN</i> , page 43). Choices are: ALL - All the ports which have been set accessible (see <i>SET ACCESSIBLE PORTS</i> , page 38); QUICK VIEW - Only those ports which have been set accessible and have been selected as quick view ports (see <i>SET QUICK VIEW PORTS</i> , page 39); POWERED ON - Only those ports which have been set accessible and are powered on; QUICK VIEW + POWERED ON - Only those ports which have been set accessible and have been selected as quick view ports and are powered on. The default is ALL. Note: The quick view choices only show up on the administrator's screen, since only he has <i>Quick View</i> setting rights (see <i>SET QUICK VIEW PORTS</i> , page 39).
Screen Blanker	If there is no input from the console for the amount of time set with this function, the screen is blanked. Key in a value from 1–30 minutes, then press [Enter] . The default setting of 0 disables this function. The screen will be blanked in the amount of time set (count from the moment when OSD is closed)
Hotkey Command Mode	Enables / disables the hotkey command function in case a conflict with programs running on the computers occurs.
Hotkey	Sets the keyboard shortcut for invoking <i>Hotkey Mode</i> (see <i>Hotkey Setting Mode</i> , page 46). Choices are: [NUM LOCK] + [-] (minus) (default), and [CTRL] + [F12] .
OSD Language	Sets the language used in the OSD. Choices are: English (Default), German, Japanese, Simplified Chinese, Traditional Chinese, Spanish, French, and Russian.

F4: Admin

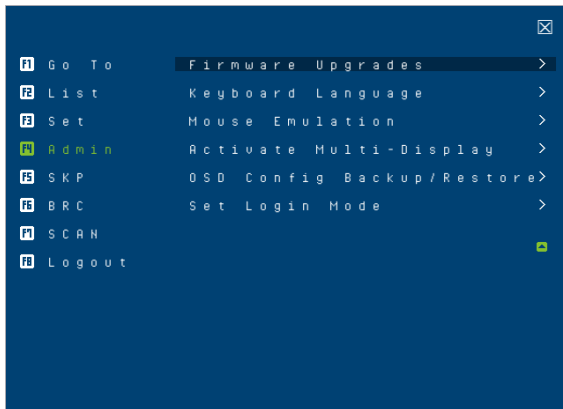

Clicking **[F4] Admin** or pressing **[F4]** activates Admin function. F4 is an administrator only function. It allows the administrator to configure and control the overall operation of the OSD. To change a setting, click on the settings item you want to configure, or use the up and down arrow keys to move the highlight bar to it then press **[Enter]**.

After you select an item, a submenu with further choices appears. Click an item, or move the highlight bar to it then press **[Enter]**. A check mark (✓) appears before the selected item so that you know which one it is. The settings are explained in the following table:

Setting	Function
Set User Login	<p>This function is used to set usernames and passwords for the administrator and users:</p> <ol style="list-style-type: none"> 1. Usernames and passwords for one administrator and four users can be set. 2. After you select the administrator field or one of the user fields, a field that allows you to key in the username and password appears. Usernames and passwords can be from 1 to 16 characters long and can consist of any combination of letters and numbers (A–Z, 0–9) and some additional keys (* () + : - , ? . / space). 3. For each individual, key in the username and password, confirm the password, choose SAVE, then press [Enter]. 4. To modify or delete a previous username and/or password, use the backspace key to erase individual letters or numbers. Press [Enter] when done. <p>Note: Usernames and passwords are not case sensitive. Usernames are displayed in capital letters in the OSD.</p>
Set Accessible Ports	<p>This function allows the administrator to define user access to the computers on the installation on a port-by-port basis.</p> <p>For each user, select the target port; then press the [Spacebar] to cycle through the choices: F (full access), V (view only), or blank. Repeat until all access rights have been set, then press [Enter]. The default is F for all users on all ports.</p> <p>Note:</p> <ul style="list-style-type: none"> ◆ A blank setting means that no access rights are granted. The port will not show up on the user's LIST on the main screen. ◆ The administrator always has full access to all ports.
Set Logout Timeout	<p>If there is no input from the console for the amount of time set with this function, the user is automatically logged out. A login is necessary before the console can be used again.</p> <p>This enables other users to gain access to the computers when the original user is no longer accessing them, but has forgotten to log out. To set the timeout value, key in a number from 1–180 minutes, then press [Enter]. The default setting of 0 disables this function.</p> <p>Note: This feature does not function if Set Login Mode is disabled. See <i>Set Login Mode</i>, page 40.</p>

Edit Port Names	<p>To help remember which computer is attached to a particular port, every port can be given a name. This function allows the administrator to create, modify, or delete port names.</p> <p>To edit a port name:</p> <ol style="list-style-type: none"> Click the port, or use the navigation keys to move the highlight bar to it. Key in the new port name, or modify/delete the old one. The maximum number of characters allowed for the port name is 12. Legal characters include: <ul style="list-style-type: none"> ◆ All alpha characters: A–Z ◆ All numeric characters: 0–9 ◆ * () + : - , ? . / <p>Case does not matter; the OSD displays the port name in all capitals no matter how they were keyed in.</p> When you have finished editing, press [Enter] to have the change take effect. To abort the change, press [Esc].
Restore Default Values	<p>This function is used to undo all changes and return the setup to the original factory default settings (See <i>Factory Default Hotkeys and Settings</i>, page 95) except for the port name list, username and password information, which are saved.</p>
Clear The Name List	<p>This function clears the port name list.</p>
Activate Beeper	<p>Choices are Y (on), or N (off). When activated, the beeper sounds whenever a port is changed; when activating the Auto Scan function (see <i>F7 SCAN</i>, page 43); or an invalid entry is made on an OSD menu. The default is Y.</p>
Set Quick View Ports	<p>This function lets the administrator select which ports to include as quick view ports.</p> <ul style="list-style-type: none"> ◆ To select/deselect a port as a quick view port, use the navigation keys to move the highlight bar to it, then press [Spacebar]. ◆ When a port has been selected as a quick view port, A check mark (\checkmark) displays in the QV column of the LIST on the main screen. When a port is deselected, the check mark (\checkmark) disappears. ◆ If one of the quick view options is chosen for the LIST view (see <i>F2 LIST</i>, page 34), only a port that has been selected here will display on the list. ◆ If one of the quick view options is chosen for auto-scanning (See <i>Scan-Skip Mode</i>, page 36), only a port that has been selected here will be auto-scanned. <p>The default has no ports selected for quick view.</p>

Set Operating System	<p>This function allows the administrator to define the operating system for the computer connected to each KVM port. The default setting is Win (PC compatible).</p> <p>To set the port operating system:</p> <ol style="list-style-type: none"> 1. From the list, select the port for which you wish to set the computer's operating system. 2. Set the operating system by pressing [Spacebar] to cycle through Win, MAC, SUN, or Other. 3. Press [Esc] to exit. The operating system you selected is assigned to the KVM port.
Firmware Upgrade	<p>In order to upgrade the CS19208 / CS19216 firmware (see page 77), you must first enable Firmware Upgrade mode with this setting.</p> <p>When you bring up this menu, the current firmware version levels are displayed. Select Y to enable Firmware Upgrade mode, or select [Esc] to leave this menu without enabling it.</p>
Keyboard Language	<p>Sets the language for the computer keyboard attached to the KVM port. To select a keyboard language, single-click it, or use the navigation keys to move the highlight bar to it, then press [Enter].</p> <p>Choices are: Auto (default), (US) English, (UK) English, German (Deutsch), German (SWISS), French, Hungarian, Italian, Japanese, Korean, Russian, Spanish, Swedish, Traditional Chinese, and Simplified Chinese.</p>
Mouse Emulation	<p>Enables / disable mouse emulation function.</p> <p>Note: Supported in the first level of an installation only. Enable mouse emulation to perform any independent switching of a port and for Auto Scan Mode or Skip Mode to work.</p>
Activate Multi-Display	<p>Enables multi-display mode for dual, triple, quad, or multi display mode in multiple-monitor installations where each computer is fitted with multiple video cards. See <i>Multi-display Installation</i>, page 22, for full details.</p> <p>Note: multi-display mode must be enabled on the OSD before the cables are connected.</p>
OSD Config Back / Restore	<p>Enters OSD Configuration Backup / Restore mode. The Firmware Management Utility lets you backup the current OSD configuration of the CS19208 / CS19216, and restore it when necessary. Storing the OSD configuration settings is useful when deploying more than one installation that uses the same settings. See <i>OSD Configuration Backup/Restore</i>, page 84, for full details.</p>
Set Login Mode	<p>This function allows the administrator to request users to login or not. When the login dialog box is disabled, the system disables the login/logout function. If the system is re-started, the login/logout function remains disabled.</p>

F5: SKP



Clicking **F5 SKP** or pressing **[F5]** invokes Skip (SKP) mode. This function enables you to easily skip backward or forward – switching the console focus from the currently active computer port to the previous or next accessible one. Enable mouse emulation for Skip mode to work (see page 40).

- ◆ The selection of computers available for skip mode switching is made with the *Scan-Skip* mode setting under the **F3: SET** function (see page 35).
- ◆ When you are in skip mode:
 - press [←] to skip to the previous accessible port on the list
 - press [→] to skip to the next accessible port on the list
 - press [↑] to skip to the previous accessible port. If the previous accessible port has cascaded a switch, then it skips to the last accessible port of that switch
 - press [↓] to skip to the next accessible port. If the next accessible port has cascaded a switch, then it skips to the first accessible port of that switch

Note: When you skip, you only skip to the previous or next accessible computer that is in the *Scan-Skip* mode selection (see page 36).

- ◆ If a port has been selected for *Scan-Skip* mode, when the focus switches to that port, a set of [↑], [↓], [←], [→] symbol appears before its port ID displays.
- ◆ While skip mode is in effect, the console will not function normally. You must exit skip mode in order to regain control of the console.
- ◆ To exit skip mode, press **[Spacebar]** or **[Esc]**.

F6: BRC

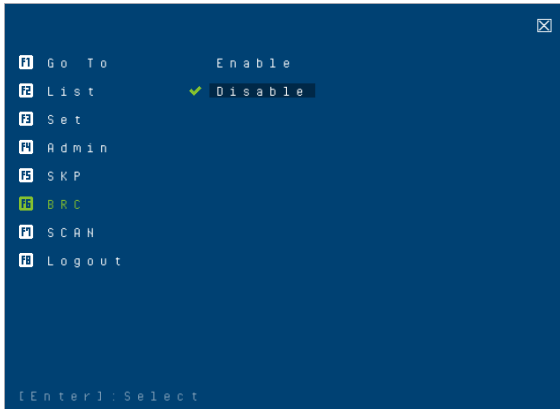

F6 is an administrator only function. Clicking **F6 BRC** or pressing **[F6]**, invokes *Broadcast* (BRC) mode. When this function is in effect, commands sent from the console are broadcast to all available computers on the installation.

This function is particularly useful for operations that need to be performed on multiple computers, such as performing a system wide shutdown, installing or upgrading software, etc.

- ◆ While BRC mode is in effect, a speaker symbol appears before the port ID display of the port that currently has the console focus. When the port ID with the speaker symbol displays.
- ◆ While BRC mode is in effect, the mouse will not function normally. You must exit BRC mode in order to regain control of the mouse.
- ◆ To exit BRC mode, invoke the OSD (with the OSD hotkey), then click the **F6** field, or press **[F6]**, to turn BRC mode off.
- ◆ When BRC mode is in effect, the Scroll Lock LED flashes. It stops flashing and reverts to normal status when you exit BRC.

F7: SCAN

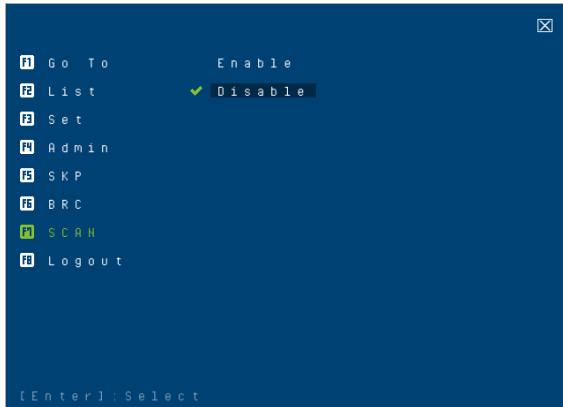

Clicking **F7** **SCAN** or pressing **[F7]** invokes *Auto Scan* mode. This function allows you to automatically switch among the available computers at regular intervals so that you can monitor their activity without having to take the trouble of switching yourself. Enable mouse emulation for *Auto Scan* to work (see page 40).

- ◆ The selection of computers to be included for auto-scanning is made with the *Scan-Skip* mode setting under the **F3: SET** function (see page 36).
- ◆ The amount of time that each port displays for is set with the *Scan Duration* setting under the **F3: SET** function (see page 36). When you want to stop at a particular location, press the [Spacebar] to stop scanning.
- ◆ If the scanning stops on an empty port, or one where the computer is attached but is powered Off, the monitor screen will be blank, and the mouse and keyboard will have no effect. After the *Scan Duration* time is up, the scan function will move on to the next port.
- ◆ As each computer is accessed, an **S** appears in front of the port ID display to indicate that it is being accessed under *Auto Scan* mode. When the port ID with the symbol displays, the background screen is blank.
- ◆ While *Auto Scan* mode is in effect, the console will not function normally. You must exit *Auto Scan* mode in order to regain control of the console.
- ◆ While you are in *Auto Scan* mode, you can pause the scanning in order to keep the focus on a particular computer either by pressing **P**, or with a left-click of the mouse. See *Invoking Auto Scan*, page 48, for details.
- ◆ To exit *Auto Scan* mode, press the [Spacebar] or [Esc].

F8: Logout

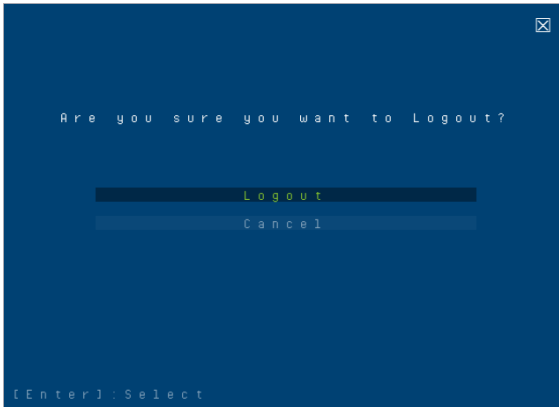

Clicking **F8 Logout**, or pressing **F8** logs you out of OSD control of the computers, and blanks the console screen. This is different from simply pressing **Esc** when you are at the main screen to deactivate the OSD. With this function you must log in all over again to regain access to the OSD, whereas with **Esc**, all you have to do to reenter the OSD is tap the OSD hotkey.

-
- Note:**
1. When you reenter the OSD after logging out, the screen stays blank except for the OSD main screen. You must input your username and password before you can continue.
 2. If you reenter the OSD after logging out, and immediately use **Esc** to deactivate the OSD without having selected a port from the OSD menu, a NULL PORT message displays on the screen. The OSD hotkey will bring up the main OSD screen.
-

Chapter 5

Hotkey Operation

Hotkey Port Control

Hotkey port control allows you to provide KVM focus to a particular computer directly from the keyboard. The CS19208 / CS19216 provides the following hotkey port control features:

- ◆ Selecting the Active Port
- ◆ Auto Scan Mode Switching
- ◆ Skip Mode Switching
- ◆ Computer Keyboard / Mouse Reset
- ◆ Enable / Disable Mouse Emulation

The following settings can also be controlled in *Hotkey Setting Mode (HSM)*:

- ◆ Setting the Beeper
- ◆ Setting the HSM Hotkey
- ◆ Setting the OSD Hotkey
- ◆ Setting the Port Operating System
- ◆ Restoring the OSD Default Values
- ◆ Setting the EDID Mode
- ◆ Setting the Video DynaSync Mode

Note: Enable mouse emulation to perform any independent switching of a port and for Auto Scan Mode or Skip Mode to work (see page 53).

Hotkey Setting Mode

Hotkey Setting Mode is used to set up your CS19208 / CS19216 switch configuration. All operations begin with invoking Hotkey Setting Mode (HSM).

Invoking HSM

To invoke HSM do the following:

1. Press and hold down [**Num Lock**].
2. Press and release [-].
3. Release [**Num Lock**].

or

1. Hold down the [**Ctrl**] key;
2. Press and release the [**F12**] key;
3. Release the [**Ctrl**] key:

When *HSM* is active:

- ◆ A command line appears on the monitor screen. The command line prompt is the word *HOTKEY:* in white text on a blue background, and displays the subsequent hotkey information that you key in.
- ◆ Ordinary keyboard and mouse functions are suspended – only hotkey compliant keystrokes (described in the sections that follow), can be input.

Pressing [**Esc**] exits *HSM*.

Select the Active Port

Each KVM port is assigned a port ID (see *Port ID Numbering*, page 26). You can directly access any computer on the installation with a hotkey combination that specifies the port ID of the KVM port that a computer is connected to. To access a computer using hotkeys:

1. Invoke HSM with the **[Num Lock] + [-]** or **[Ctrl] + [F12]** combination.
2. Key in the port ID.

The port ID numbers display on the command line as you key them in. If you make a mistake, use **[Backspace]** to erase the wrong number.

3. Press **[Enter]**.

After you press **[Enter]**, the KVM focus switches to the designated computer and you automatically exit HSM.

Note: In HSM, KVM focus will not switch to a port if an invalid switch or port number is entered. The hotkey command line will continue to display on the screen until you enter a valid switch and port number combination, or exit HSM.

Hotkey	Action
[PN] [Enter]	Brings the KVM , USB hub , and audio focus to the computer attached to the port corresponding to the specified Port ID.
[PN] [K] [Enter]	Brings only the KVM and audio focus to the computer attached to the specified port. The USB hub and audio focus remain where they are.
[PN] [U] [Enter]	Brings only the USB hub focus to the computer attached to the specified port. The KVM and audio focus remain where they are.

Note: The **[PN]** stands for the computer's Port ID number (1, 2, 3, or 4). See *Port ID Numbering*, page 26 for details. Replace the **[PN]** with the appropriate Port ID when entering Hotkey combinations.

Auto Scan Mode

Auto Scan automatically switches, at regular intervals, among all the KVM ports that have been set as accessible under *Scan–Skip Mode*, so that their activity can be monitored automatically. See *Scan–Skip Mode* on page 36 for more information.

Invoking Auto Scan:

To start *Auto Scan*, key in the following Hotkey combination:

1. Enable mouse emulation (see page 53).
2. Invoke *HSM* with the **[Num Lock] + [-]** or **[Ctrl] + [F12]** combination.
3. Press **[A]**. After you press **A**, then **[Enter]**, you automatically exit *HSM*, and enter *Auto Scan* mode.
 - ♦ While you are in *Auto Scan* mode, you can pause the scanning in order to keep the focus on a particular computer either by pressing **P** or with a left click of the mouse. During the time that auto-scanning is paused, the command line displays: **AUTO SCAN: PAUSED**.

Pausing when you want to keep the focus on a particular computer is more convenient than exiting *Auto Scan* mode because when you resume scanning, you start from where you left off. If, on the other hand, you exited and restarted, scanning would start over from the very first computer on the installation.

To resume Auto Scanning, press any key or left-click. Scanning continues from where it left off.

- ♦ While *Auto Scan* mode is in effect, ordinary keyboard and mouse functions are suspended – only *Auto Scan* mode compliant keystrokes and mouse clicks can be input. You must exit *Auto Scan* mode in order to regain normal control of the console.
4. To exit *Auto Scan* mode press **[Esc]** or **[Spacebar]**. Auto-scanning stops when you exit *Auto Scan* mode.

Note: Enable mouse emulation to perform any independent switching of a port and for Auto Scan Mode or Skip Mode to work (see page 53)

Skip Mode

This feature allows you to switch between computers in order to monitor them manually. You can dwell on a particular port for as long as you like – as opposed to auto-scanning, which automatically switches after a fixed interval. To invoke *Skip* mode, key in the following hotkey combination:

1. Enable mouse emulation (see page 53).
2. Invoke *HSM* with the [Num Lock] + [-] or [Ctrl] + [F12] combination.
3. Key in [↑], [↓], [←], or [→].
 - ◆ After you press an arrow key, you automatically exit *HSM* and enter *Skip* mode where you can switch ports as follows:

←	Skips to the previous accessible port. (See <i>Scan/Skip Mode</i> , page 36, for information regarding accessible ports.)
→	Skips to the next accessible port.
↑	Skips to the previous accessible port. If the previous accessible port has cascaded a switch, then it skips to the last accessible port of that switch.
↓	Skips to the next accessible port. If the next accessible port has cascaded a switch, then it skips to the first accessible port of that switch.

- ◆ Once you are in *Skip* mode, you can keep on skipping by pressing the arrow keys. You don't have to use the [Num Lock] + [-] combination again.
 - ◆ While *Skip* mode is in effect, ordinary keyboard and mouse functions are suspended – only *Skip* mode compliant keystrokes can be input. You must exit *Skip* mode in order to regain normal control of the console.
4. To exit *Skip* mode, press [Esc] or [Spacebar].

Note: Enable mouse emulation to perform any independent switching of a port and for Auto Scan Mode or Skip Mode to work (see page 53).

Keyboard / Mouse Reset

If the keyboard or mouse cease to function on the computer connected to the currently selected port, you can perform a keyboard / mouse reset on the computer. This function is essentially the same as unplugging and replugging the keyboard and mouse on the target computer. To perform a computer keyboard / mouse reset, key in the following hotkey combination:

1. Invoke *HSM* with the **[Num Lock] + [-]** or **[Ctrl] + [F12]** combination.
2. Press **[F5]**.

After you press **[F5]** you automatically exit *HSM* and regain keyboard and mouse control on the computer connected to the KVM port. If you fail to regain keyboard / mouse control on the computer after pressing **[F5]**, perform a console keyboard and mouse reset.

Hotkey Beeper Control

The beeper (see Activate Beeper, page 39) can be hotkey toggled on and off. The default setting is enabled. To toggle the beeper, key in the following hotkey combination:

1. Invoke *HSM* with the **[Num Lock] + [-]** or **[Ctrl] + [F12]** combination.
2. Press **[B]**.

After you press **[B]**, the beeper toggles on or off. The command line displays *BEEPER ON* or *BEEPER OFF* for one second; then the message disappears and you automatically exit *HSM*.

HSM Hotkey Control

The *HSM Hotkey* (see *Hotkey*, page 36) can be toggled between **[Num Lock] + [-]**, and **[Ctrl] + [F12]**. To toggle the *HSM Hotkey*:

1. Invoke *HSM* with the **[Num Lock] + [-]** or **[Ctrl] + [F12]** combination.
2. Press **[H]**.

After you press **[H]**, the command line displays *HOTKEY HAS BEEN CHANGED* for one second; then the message disappears and you automatically exit *HSM*.

OSD Hotkey Control

The *OSD Hotkey* (see *OSD Hotkey*, page 35) can be toggled between [Scroll Lock], [Scroll Lock] and [Ctrl], [Ctrl]. To toggle the *OSD Hotkey*, key in the following hotkey combination:

1. Invoke *HSM* with the [Num Lock] + [-] or [Ctrl] + [F12] combination.
2. Press [T].

After you press [T], the command line displays *HOTKEY HAS BEEN CHANGED* for one second; then the message disappears and you automatically exit *HSM*.

Port OS Control

A port's operating system can be changed to match that of the computer attached to the port. To change a port's operating system, key in the following hotkey combination:

1. Invoke *HSM* with the [Num Lock] + [-] or [Ctrl] + [F12] combination.
2. Key in [F1], [F2], or [F3], the Function of [F1], [F2], and [F3] keys is listed in the following table:

Key	Description
F1	Sets the Port OS to Windows
F2	Sets the Port OS to Mac
F3	Sets the Port OS to Sun

After pressing a function key you automatically exit *HSM*.

Restore Default Values

This administrator-only hotkey restores the CS19208 / CS19216 default values. see *Factory Default Hotkeys and Settings*, page 95. To restore the default values, key in the following hotkey combination:

1. Invoke *HSM* with the **[Num Lock] + [-]** or **[Ctrl] + [F12]** combination.
2. Press **[R]**.
3. Press **[Enter]**.

After you press [Enter], the command line displays *RESET TO DEFAULT SETTING* for one second; then the message disappears and you automatically exit *HSM*.

Video DynaSync

Video DynaSync is ATEN's exclusive technology that eliminates boot-up display problems and optimizes resolution when switching between ports. The default setting is enabled. To invoke Video DynaSync, do the following:

1. Invoke *HSM* with the **[Num Lock] + [-]** or **[Ctrl] + [F12]** combination.
2. Press **[D]**.

Note: If the monitor is disconnected and reconnected, the CS19208 / CS19216 re-executes Video DynaSync.

EDID Mode

To configure an EDID mode for the CS19208 / CS19216, do the following:

1. Invoke *HSM* with the [Num Lock] + [-] or [Ctrl] + [F12] combination.
2. Press [V].
3. Key in [1], [2], [3], or [4], the Function of [1], [2], [3], and [4] keys is listed in the following table:

Key	Description
1	Sets the switch to read DisplayPort monitor's EDID (Default)
2	Sets the switch to read HDMI monitor's EDID
3	Sets the switch to ATEN default EDID mode
4	Sets the switch to remix mode

4. Press [Enter]. After pressing [Enter] you automatically exit *HSM*.

Mouse Emulation Control

The default setting is enabled. To disable, do the following:

1. Invoke *HSM* with the [Num Lock] + [-] or [Ctrl] + [F12] combination.
2. Press [M].

This procedure is a toggle. Repeat to enable.

Note: Enable mouse emulation to perform any independent switching of a port and for Auto Scan Mode or Skip Mode to work.

HSM Summary Table

After invoking HSM (see page 46), key in one of the following keys to perform the corresponding function:

Key	Function
[<i>PN</i>] [Enter]	Switches KVM, Audio, and USB focus directly to the computer that corresponds to that port ID. (<i>PN</i> = port number)
[<i>PN</i>] [K] [Enter]	Switches KVM and Audio focus directly to the computer that corresponds to that port ID. (<i>PN</i> = port number)
[<i>PN</i>] [U] [Enter]	Switches USB focus only directly to the computer that corresponds to that port ID. (<i>PN</i> = port number) Note: This hotkey functions on the first level of an installation only.
[A] [Enter]	Starts Auto Scan. The KVM focus cycles from port to port at the default 5-second intervals
[A] [<i>n</i>] [Enter]	Starts Auto Scan at <i>n</i> -second intervals (<i>n</i> = 0–255 seconds) Note: When <i>n</i> =0, the Auto Scan will not be activated.
[H]	Toggles between the default ([Num Lock] [-]) and alternate ([Ctrl] [F12]) HSM invocation keys.
[T]	Toggles between the default ([Scroll Lock] [Scroll Lock]) and alternate ([Ctrl] [Ctrl]) OSD Hotkey.
[F1]	Sets the port OS to Windows.
[F2]	Sets the port OS to Mac.
[F3]	Sets the port OS to Sun.
[F5]	Performs a keyboard / mouse reset on the target computer.
[B]	Enables/Disables the beeper.
[R] [Enter]	Resets the hotkey settings to their default status. See <i>Factory Default Hotkeys and Settings</i> , page 95.
[D]	Invokes Video DynaSync, ATEN's exclusive technology that eliminates boot-up display problems and optimizes resolution when switching between ports.

Key	Function
[V] [n] [Enter]	Sets EDID Mode. <ul style="list-style-type: none"> ◆ n = 1, read DisplayPort monitor's EDID. ◆ n = 2, read HDMI monitor's EDID. ◆ n = 3, ATEN default EDID mode (Full HD 1920 x 1080 @60Hz). ◆ n = 4, Remix mode.
[M]	Enables/Disables mouse emulation.
[←]	Skips to the previous computer on the list, in skip mode.
[→]	Skips to the next computer on the list, in skip mode.
[↑]	Skips to the previous accessible port. If the previous accessible port has cascaded a switch, then it skips to the last accessible port of that switch.
[↓]	Skips to the next accessible port. If the next accessible port has cascaded a switch, then it skips to the first accessible port of that switch.
[ESC] or [Spacebar]	Exits hotkey setting mode.

Note: Enable mouse emulation to perform any independent switching of a port and for Auto Scan Mode or Skip Mode to work (see page 53).









This Page Intentionally Left Blank

Chapter 6

Keyboard Emulation

Mac Keyboard







The PC compatible (101/104 key) keyboard can emulate the functions of the Mac keyboard. The emulation mappings are listed in the table below.

PC Keyboard	Mac Keyboard
[Shift]	Shift
[Ctrl]	Ctrl
	
[Ctrl] [1]	
[Ctrl] [2]	
[Ctrl] [3]	
[Ctrl] [4]	
[Alt]	Alt
[Print Screen]	F13
[Scroll Lock]	F14
	=
[Enter]	Return
[Backspace]	Delete
[Insert]	Help
[Ctrl] 	F15

Note: When using key combinations, press and release the first key (Ctrl), then press and release the activation key.

Sun Keyboard

The PC compatible (101/104 key) keyboard can emulate the functions of the Sun keyboard when the Control key [Ctrl] is used in conjunction with other keys. The corresponding functions are shown in the table below.

PC Keyboard	Sun Keyboard
[Ctrl] [T]	Stop
[Ctrl] [F2]	Again
[Ctrl] [F3]	Props
[Ctrl] [F4]	Undo
[Ctrl] [F5]	Front
[Ctrl] [F6]	Copy
[Ctrl] [F7]	Open
[Ctrl] [F8]	Paste
[Ctrl] [F9]	Find
[Ctrl] [F10]	Cut
[Ctrl] [1]	
[Ctrl] [2]	
[Ctrl] [3]	
[Ctrl] [4]	
[Ctrl] [H]	Help
	Compose
	

Note: When using key combinations, press and release the first key (Ctrl), then press and release the activation key.

Chapter 7

RS-232 Operation

Overview

The CS19208 / CS19216's built-in bi-directional RS-232 serial interface allows system control through a high-end controller or PC. RS-232 serial operations in a CS19208 / CS19216 installation are managed via HyperTerminal sessions on systems that are running Windows. In order to use this feature to send commands to the CS19208 / CS19216, you must first download and install a HyperTerminal application.

Setup

Install a HyperTerminal application on a computer that is not part of the installation, which will be used to control the switch via the RS-232 connection. HyperTerminal applications can be download from the Internet, and many operating systems are embedded with HyperTerminal applications.

Hardware Connection

Use a the *Firmware Upgrade Cable* provided with this unit to connect a computer's serial port to the Firmware Upgrade Port on the CS19208 / CS19216's front panel, as shown below:

Note: The unit used in the diagram below is CS19216, the procedure for connecting CS19208 is identical with fewer KVM ports.

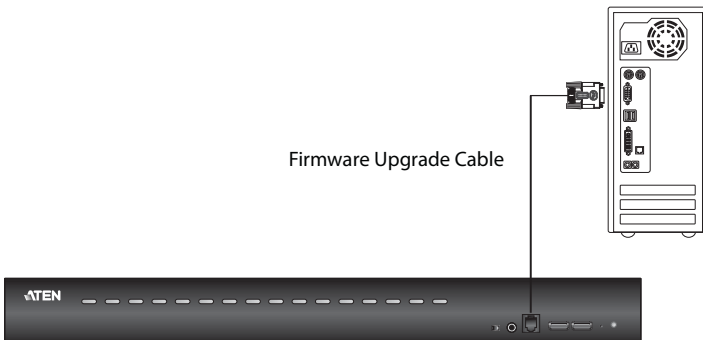

RS-232 Pin Assignments

Pin assignments for the CS19208 / CS19216's Firmware Upgrade Port that is used for connecting to a serial terminal are given in the table, below:

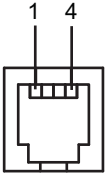
Pin	Assignment	
1	TXD: Transmit Data	 <p>The diagram shows a top-down view of an RJ-11 female connector. It has a rectangular shape with a notch on the right side. Two pins are shown protruding from the top edge, labeled '1' and '4'. The connector is shown in a simplified line-art style.</p>
2	RXD: Receive Data	
3	N/A	
4	GND: Signal Ground	

RJ-11 Female

Console Login - HyperTerminal

Once a physical connection from the computer to the CS19208 / CS19216 has been made, you can establish a HyperTerminal session using the instructions below.

1. Open the *HyperTerminal* application, and configure the port settings for COM1 port, then click **OK**.

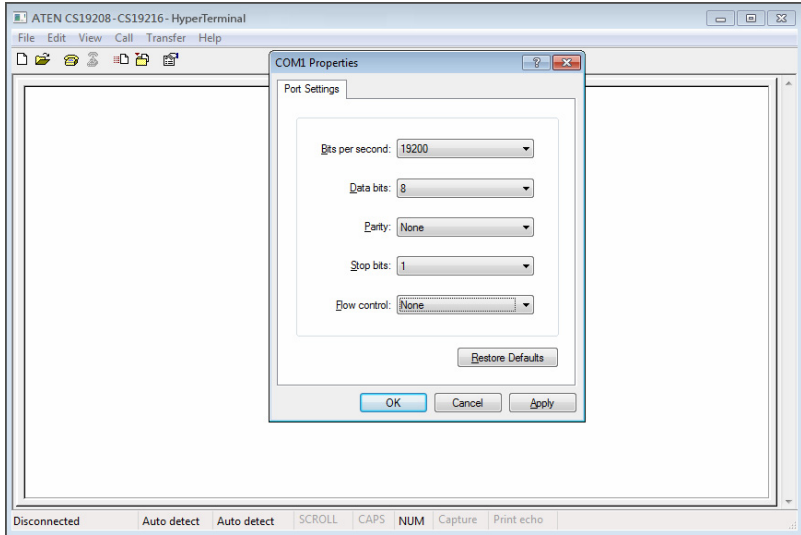

Bits per Second: **19200**, Data Bits: **8**, Parity: **None**, Stop bits: **1**, Flow Control: **None**.

2. After configuring the port settings you must enable serial control on the switch by typing the command: **Open + [Enter]**.

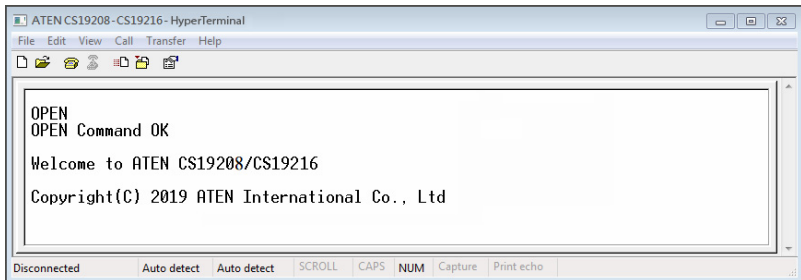

RS-232 Commands

After you login via HyperTerminal (see *Console Login - HyperTerminal*) use the instructions below to send RS-232 commands to control the switch from the computer.

When RS-232 control is enabled via the **Open + [Enter]** command, the CS19208 / CS19216's front panel pushbuttons, OSD, hotkeys, and remote control commands will be disabled - until the RS-232 control is disabled.

Verification

After entering a command, a verification message appears, as shown below, at the end of the command line, as follows:

Response Message	Description
Command OK	Command or parameter is correct.
Command incorrect	Command or parameter is incorrect.

With all commands in the sections that follow:

- ◆ Each command string can be separated with a space.
- ◆ The [Enter] command can be replaced with the ASCII code: 0x0D0A

Login

The *Login* command allows you to login to the CS19208 / CS19216 and begin sending RS-232 commands. When you login the RS-232 link is “opened”, and the CS19208 / CS19216 will not respond to front panel pushbuttons, hotkeys, OSD, or remote control commands - until the RS-232 link is closed (see *Switch Port*, page 67).

Use the **Formula** - to set **Parameters** - to create a **Command**.

Formulas:

Command + Control + Name + Number + [Enter]

Parameters:

Command	Description
login	Login command

Control	Description
U	Input user name + password

Name	Description
xxxxxxxxxxxxx	The login user name

Password	Description
xxxxxxxxxxxxx	The login user password

Enter	Description
Enter	Enter and send out command

Login Command

The available formula for the Login command is as follows:

1. Command + Control + Name + Number + [Enter]

For example, to login via username and password, type the following:

login u administrator p12345 [Enter]

Logout

The *Logout* commands allows you to logout of the CS19208 / CS19216 and close the RS-232 link.

Use the **Formula** - to set **Parameters** - to create a **Command**.

Formulas:

Command + [Enter]

Parameters:

Command	Description
logout	Logout command

Enter	Description
Enter	Enter and send out command

Logout Command

The available formula for the Logout command is as follows:

1. Command + [Enter]

For example, to logout of the CS19208 / CS19216, type the following:

logout [Enter]

Open / Close RS-232 Link

The *Open* and *Close RS-232 Link* commands allows you to open/close the link between the computer sending RS-232 commands and the CS19208 / CS19216. When the link is open, the CS19208 / CS19216 only accepts RS-232 commands and will not respond to front panel pushbuttons, OSD, hotkeys, and remote control commands - until the link is closed. The link opens when you login and closes after 2 minutes if no command is sent.

Use the **Formula** - to set **Parameters** - to create a **Command**.

Formulas:

Command + [Enter]

Parameters:

Command	Description
open	Open RS-232 Link command
close	Close RS-232 Link command

Enter	Description
Enter	Enter and send out command

Open/Close RS-232 Link Commands

The available formulas for the Open/Close RS-232 Link commands are as follows:

1. Command + [Enter]

For example, to open the RS-232 link between the computer and CS19208 / CS19216, type the following:

open [Enter]

2. Command + [Enter]

For example, to close the RS-232 link between the computer and CS19208 / CS19216, type the following:

close [Enter]

Set Baud Rate

The *Set Baud Rate* command allows you to configure the baud rate setting for the serial port connection. The default baud rate is 19200.

Use the **Formula** - to set **Parameters** - to create a **Command**.

Formulas:

Command + Control + [Enter]

Parameters:

Command	Description
baud	Baud Rate Command

Control	Description
19200	Set baud rate to 19200 (Default)
38400	Set baud rate to 38400
9600	Set baud rate to 9600

Enter	Description
Enter	Enter and send out command

Set Baud Rate Commands

The available formulas for the Set Baud Rate commands are as follows:

1. Command + Control + [Enter]

For example, to set the baud rate to 19200, type the following:

baud 19200 [Enter]

2. Command + Control + [Enter]

For example, to set the baud rate to 38400, type the following:

baud 38400 [Enter]

Switch Port

The *Switch Port* command allows you to switch ports. The default port is 01.

Use the **Formula** - to set **Parameters** - to create a **Command**.

Formula:

Command + Control + [Enter]

Parameters:

Command	Description
sw	Switch Port Command
Control	Description
ixx	Input Port Number xx= 01~08 (CS19208); 01~16 (CS19216)
Enter	Description
Enter	Enter and send out command

Switch Port Commands

The available formula for the Switch Port command is as follows:

1. Command + Control + [Enter]

For example, to switch to port 2, type the following:

sw i02 [Enter]

Note: The **Control** command can be skipped and the default value will be used.

Hotkey Setting

The *Hotkey Setting* command allows you to change the hotkey used to invoke the HSM (Hotkey Setting Mode). The default hotkey is [Num Lock] + [-].

Use the **Formula** - to set **Parameters** - to create a **Command**.

Formulas:

Command + Control + [Enter]

Parameters:

Command	Description
hotkey	Hotkey Setting Command

Control	Description
num	Change the HSM invoke key to: [Num Lock] + [-] (Default)
f12	Change the HSM invoke key to: [Ctrl] + [F12]

Enter	Description
Enter	Enter and send out command

Hotkey Setting Commands

The available formulas for Hotkey Setting commands are as follows:

1. Command + Control + [Enter]

For example, to change the HSM invoke key to [Num Lock] + [-], type the following:

hotkey num [Enter]

2. Command + Control + [Enter]

For example, to change the HSM invoke key to [Ctrl] + [F12], type the following:

hotkey f12 [Enter]

OSD Hotkey

The *OSD Hotkey* command allows you to change the hotkey used to invoke the OSD. The default hotkey is [Scroll][Scroll].

Use the **Formula** - to set **Parameters** - to create a **Command**.

Formulas:

Command + Control + [Enter]

Parameters:

Command	Description
osdkey	OSD Hotkey Command

Control	Description
scroll	Change OSD hotkey invoke key to: [Scroll] [Scroll] (Default)
ctrl	Change OSD hotkey invoke key to: [Ctrl] [Ctrl]

Enter	Description
Enter	Enter and send out command

Hotkey Switching Commands

The available formulas for OSD Hotkey commands are as follows:

1. Command + Control + [Enter]

For example, to change the OSD hotkey invoke key to [Scroll] [Scroll], type the following:

osdkey scroll [Enter]

2. Command + Control + [Enter]

For example, to change the OSD hotkey invoke key to [Ctrl] [Ctrl], type the following:

osdkey ctrl [Enter]

USB Reset

The *USB Reset* command allows you to reset the USB connection. The default USB reset setting is off.

Use the **Formula** - to set **Parameters** - to create a **Command**.

Formulas:

Command + Control + [Enter]

Parameters:

Command	Description
usbreset	USB Reset Command

Control	Description
on	Enable USB reset connection

Enter	Description
Enter	Enter and send out command

USB Reset Command

The available formula for the USB Reset command is as follows:

1. Command + Control + [Enter]

For example, to reset the USB connection, type the following:

usbreset on [Enter]

Restore Default Settings

The *Restore Default Settings* command allows you to reset all of the CS19208 / CS19216's settings back to the default. The default setting is off.

Use the **Formula** - to set **Parameters** - to create a **Command**.

Formulas:

Command + Control + [Enter]

Parameters:

Command	Description
reset	Restore Default Settings Command

Control	Description
on	Enable restore default values

Enter	Description
Enter	Enter and send out command

Restore Default Value Command

The available formula for the Restore Default Settings command is as follows:

1. Command + Control + [Enter]

For example, to restore all CS19208 / CS19216's settings back to the default, type the following:

reset on [Enter]

Firmware Upgrade

The *Firmware Upgrade* command allows you to enable the firmware upgrade mode. The default setting is off.

Use the **Formula** - to set **Parameters** - to create a **Command**.

Formulas:

Command + Control+ [Enter]

Parameters:

Command	Description
upgrade	Firmware Upgrade Command

Control	Description
on	Enable firmware upgrade mode

Enter	Description
Enter	Enter and send out command

Firmware Upgrade Command

The available formula for the Firmware Upgrade command is as follows:

1. Command + Control + [Enter]

For example, to enable firmware upgrade mode, type the following:

upgrade on [Enter]

KVM Status

The *KVM Status* command allows you to display read-only information about the CS19208 / CS19216' current configuration status. The default setting is off.

Use the **Formula** - to set **Parameters** - to create a **Command**.

Formulas:

Command + Control + [Enter]

Parameters:

Command	Description
status	KVM Status Command
Control	Description
on	Enable KVM status
Enter	Description
Enter	Enter and send out command

KVM Status Command

The available formula for the KVM Status command is as follows:

1. Command + Control + [Enter]

For example, to display the CS19208 / CS19216's configuration status, type the following:

status on [Enter]

A message similar to the one below will then appear:

hotkey: [numlock]+[-] / [scrolllock],[scrolllock]

os setting: pc

keyboard emulation: enabled/disabled

keyboard layout: English

mouse emulation: enabled/disabled

monitor re-detection: enabled/disabled

EDID Mode see VS482B

The *EDID Mode* command allows you to set EDID mode for the CS19208 / CS19216.

Use the **Formula** - to set **Parameters** - to create a **Command**.

Formulas:

Command + Control + [Enter]

Parameters:

Command	Description
edid	Set EDID Mode Command

Control	Description
port1	Set to display A (DisplayPort monitor) EDID
port2	Set to display B (HDMI monitor) EDID
default	Set to ATEN default EDID
remix	Set to remix mode

Enter	Description
Enter	Enter and send out command

EDID Mode Command

The available formula for the KVM Status command is as follows:

1. Command + Control + [Enter]

For example, to set the CS19208 / CS19216's EDID mode to ATEN default EDID, type the following:

edid default [Enter]

Broadcast Mode

The *Broadcast Mode* command allows you to set enable/disable broadcast mode for the CS19208 / CS19216. The default setting is off.

Use the **Formula** - to set **Parameters** - to create a **Command**.

Formulas:

Command + Control + [Enter]

Parameters:

Command	Description
broadcast	Set Broadcast Mode Command

Control	Description
on	Enable broadcast mode for CS19208 / CS19216
off	Disable broadcast mode for CS19208 / CS19216

Enter	Description
Enter	Enter and send out command

Broadcast Mode Command

The available formula for the KVM Status command is as follows:

1. Command + Control + [Enter]

For example, to enable the CS19208 / CS19216's broadcast mode, type the following:

broadcast on [Enter]

This Page Intentionally Left Blank

Chapter 8

The Firmware Management Utility

Introduction

The purpose of the Windows-based Firmware Management Utility is to provide an automated process for upgrading all CS19208 / CS19216 switches in an installation. The program comes as part of a Firmware Upgrade Package that is specific for each device.

As new firmware versions become available, new firmware upgrade packages are posted on our website. Check the website regularly to find the latest information and packages.

Downloading the Firmware Upgrade Package

To download the firmware upgrade package:

1. From a computer that is not part of your KVM installation go to our website and choose the model name that relates to your device. A list of available firmware upgrade packages appears.
2. Choose the firmware upgrade package that you wish to install (usually the most recent) and download it to your computer.

Preparation

To prepare for the firmware upgrade, do the following:

1. Use the *Firmware Upgrade Cable* provided with this unit to connect a COM port on your computer to the *Firmware Upgrade Port* of your switch.

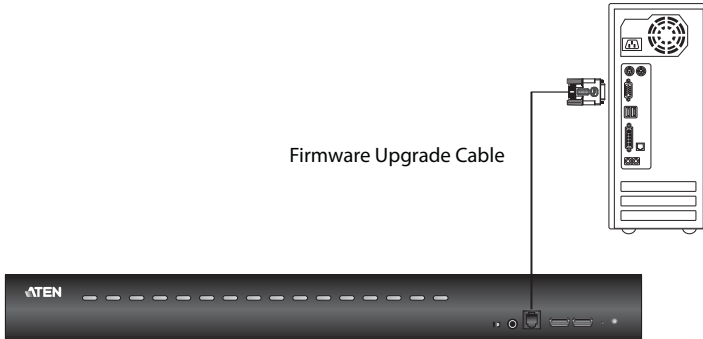

2. Shut down all the computers on the KVM installation.
3. From your KVM switch console, login to the OSD as the administrator (see p. 29) and select the **F4 Admin** function.
4. Scroll down to **Firmware Upgrades**. Press **[Enter]**, then press **[Y]** to invoke *Firmware Upgrade* mode (see p. 40).

Or

Invoke the *Firmware Upgrade* mode using RS-232 command (see p. 72).

Starting the Upgrade

To upgrade the firmware:

1. Run the downloaded firmware upgrade package file either by double-clicking the file icon, or by opening a command line and entering the full path to it.

The *Firmware Upgrade Utility* welcome screen appears:

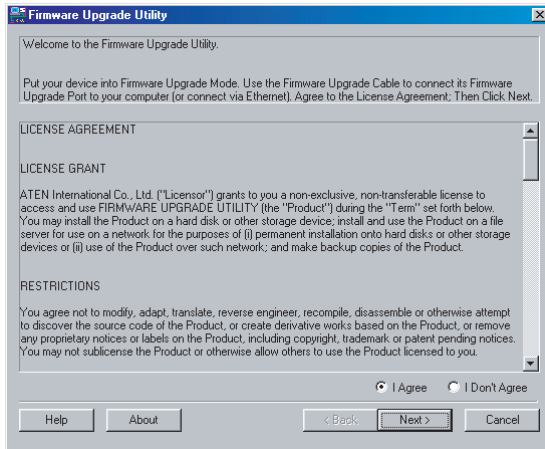

Note: The screens shown in this section are for reference only. The wording and layout of the actual screens put up by the *Firmware Upgrade Utility* may vary slightly from these examples.

2. Read and *Agree* to the License Agreement (enable the I Agree radio button).

3. Click **Next** to continue. The *Firmware Upgrade Utility* main screen appears. The devices capable of being upgraded are listed in the *Device List* panel:

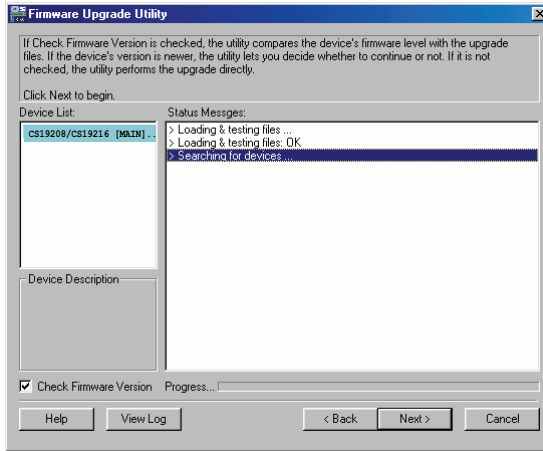

4. As you select a device in the list, its description appears in the *Device Description* panel.

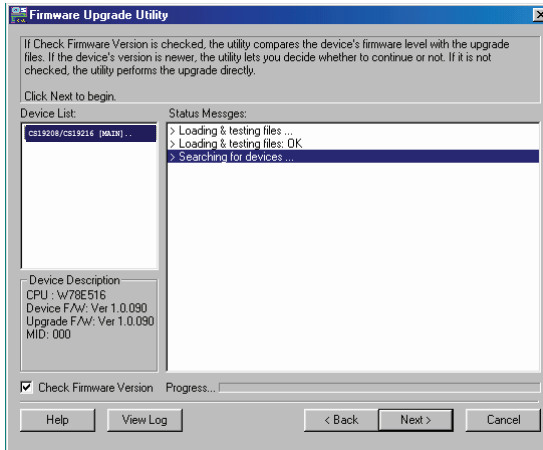

5. Click **Next** to perform the upgrade.

If you enabled *Check Firmware Version*, the Utility compares the device's firmware level with that of the upgrade files. If it finds that the device's version is higher than the upgrade version, it brings up a dialog box

informing you of the situation and gives you the option to continue or cancel.

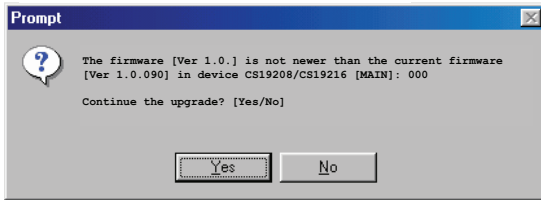

If you didn't enable *Check Firmware Version*, the Utility installs the upgrade files without checking whether they are a higher level, or not.

As the upgrade proceeds, status messages appear in the *Status Messages* panel, and the progress toward completion is shown on the *Progress* bar.

Upgrade Succeeded

After the upgrade has completed, a screen appears to inform you that the procedure was successful.

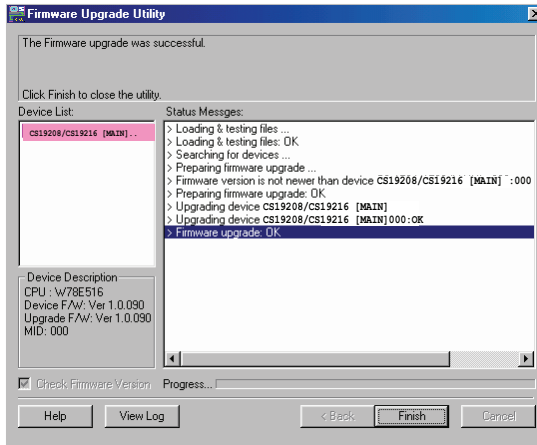

Click **Finish** to close the *Firmware Upgrade Utility*.

After a successful completion, the switches exit Firmware Upgrade Mode, and reset themselves.

Upgrade Failed

If the *Upgrade Succeeded* screen doesn't appear, it means that the upgrade failed to complete successfully. See the next section, *Firmware Upgrade Recovery*, for how to proceed.

Firmware Upgrade Recovery

There are three conditions that call for firmware upgrade recovery:

- ◆ When a firmware upgrade is manually aborted.
- ◆ When the mainboard firmware upgrade fails.
- ◆ When the I/O firmware upgrade fails.

To perform a firmware upgrade recovery, do the following:

1. Power off the switch.
2. Connect the *Firmware Upgrade Cable* to its *Firmware Upgrade Port*.
3. Slide the *Firmware Upgrade Recovery Switch* to the **Recover** position.
4. Power the switch back on and repeat the upgrade procedure.
5. After the switch has been successfully upgraded, power it off, and slide the *Firmware Upgrade Recovery Switch* back to the **Normal** position.
6. If the switch is one of the cascaded switches, plug it back into the installation.
7. Power the switch back on.

OSD Configuration Backup/Restore

The Firmware Management Utility lets you backup the current OSD configuration of the CS19208 / CS19216, and restore it when necessary. Storing the OSD configuration settings is useful when deploying more than one installation that uses the same settings.

Backup

Follow these steps to store a backup file to a local computer:

1. Make sure your computer is connected to the CS19208 / CS19216. See *Preparation*, page 78, and follow steps 1–3.
2. When you have selected the **F4 Admin** function, scroll down to OSD Config Backup / Restore. Press **[Enter]**, then select **Enable** to invoke *OSD Config Backup / Restore* mode.
3. Run the Firmware Management Utility. In the dialog box, choose *OSD Configuration Backup/Restore*, then click Next.
4. In the window that appears, click *Connect Device*.

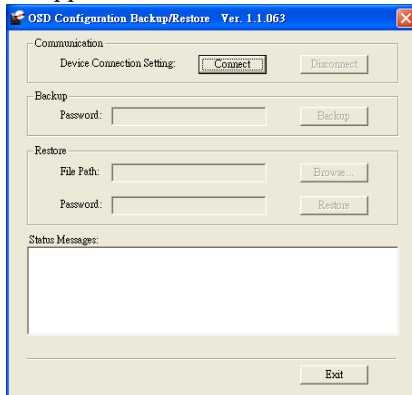

5. In the *Password* field, key in a password for the file.

Note: Setting a password is optional. If you do not set one, the file can be restored without specifying a password.

6. Click **Backup**.
7. When the browser asks what you want to do with the file, select *Save to disk*, then save it in a convenient location.

Restore

Follow these steps to restore a backup file from a local computer:

1. Do steps 1 to 3 of the previous section. See *Backup*, page 84.
2. Click **Restore** to recover an OSD configuration stored in the local computer. If you have previously set a password for this feature, enter the password in the provided field before clicking **Restore**. A confirmation window appears; click **Yes** to proceed.
3. Browse for the OSD configuration file you want to use and click **Restore**. Make sure the backup file is in the local computer.
4. A confirmation window appears when the restore process is done and successful. Click **OK** to close it.

This Page Intentionally Left Blank

Safety Instructions

General

- ◆ This product is for indoor use only.
- ◆ Read all of these instructions. Save them for future reference.
- ◆ Follow all warnings and instructions marked on the device.
- ◆ Do not place the device on any unstable surface (cart, stand, table, etc.). If the device falls, serious damage will result.
- ◆ Do not use the device near water.
- ◆ Do not place the device near, or over, radiators or heat registers.
- ◆ The device cabinet is provided with slots and openings to allow for adequate ventilation. To ensure reliable operation, and to protect against overheating, these openings must never be blocked or covered.
- ◆ The device should never be placed on a soft surface (bed, sofa, rug, etc.) as this will block its ventilation openings. Likewise, the device should not be placed in a built in enclosure unless adequate ventilation has been provided.
- ◆ Never spill liquid of any kind on the device.
- ◆ Unplug the device from the wall outlet before cleaning. Do not use liquid or aerosol cleaners. Use a damp cloth for cleaning.
- ◆ The device should be operated from the type of power source indicated on the marking label. If you are not sure of the type of power available, consult your dealer or local power company.
- ◆ To prevent damage to your installation it is important that all devices are properly grounded.
- ◆ Do not allow anything to rest on the power cord or cables. Route the power cord and cables so that they cannot be stepped on or tripped over.
- ◆ Position system cables and power cables carefully; Be sure that nothing rests on any cables.
- ◆ Never push objects of any kind into or through cabinet slots. They may touch dangerous voltage points or short out parts resulting in a risk of fire or electrical shock.
- ◆ Do not attempt to service the device yourself. Refer all servicing to qualified service personnel.

- ◆ If the following conditions occur, unplug the device from the wall outlet and bring it to qualified service personnel for repair.
 - ◆ The power cord or plug has become damaged or frayed.
 - ◆ Liquid has been spilled into the device.
 - ◆ The device has been exposed to rain or water.
 - ◆ The device has been dropped, or the cabinet has been damaged.
 - ◆ The device exhibits a distinct change in performance, indicating a need for service.
 - ◆ The device does not operate normally when the operating instructions are followed.
- ◆ Only adjust those controls that are covered in the operating instructions. Improper adjustment of other controls may result in damage that will require extensive work by a qualified technician to repair.
- ◆ Do not connect the RJ-11 connector marked “UPGRADE” to a public telecommunication network.

Rack Mounting

- ◆ Before working on the rack, make sure that the stabilizers are secured to the rack, extended to the floor, and that the full weight of the rack rests on the floor. Install front and side stabilizers on a single rack or front stabilizers for joined multiple racks before working on the rack.
- ◆ Always load the rack from the bottom up, and load the heaviest item in the rack first.
- ◆ Make sure that the rack is level and stable before extending a device from the rack.
- ◆ Use caution when pressing the device rail release latches and sliding a device into or out of a rack; the slide rails can pinch your fingers.
- ◆ After a device is inserted into the rack, carefully extend the rail into a locking position, and then slide the device into the rack.
- ◆ Do not overload the AC supply branch circuit that provides power to the rack. The total rack load should not exceed 80 percent of the branch circuit rating.
- ◆ Make sure that all equipment used on the rack – including power strips and other electrical connectors – is properly grounded.
- ◆ Ensure that proper airflow is provided to devices in the rack.
- ◆ Ensure that the operating ambient temperature of the rack environment does not exceed the maximum ambient temperature specified for the equipment by the manufacturer.
- ◆ Do not step on or stand on any device when servicing other devices in a rack.
- ◆ **Caution:** Slide/rail (LCD KVM) mounted equipment is not to be used as a shelf or a work space.



Technical Support

International

- ◆ For online technical support – including troubleshooting, documentation, and software updates: <http://support.aten.com>
- ◆ For telephone support, see *Telephone Support*, page iii:

North America

Email Support		support@aten-usa.com
Online Technical Support	Troubleshooting Documentation Software Updates	http://www.aten-usa.com/support
Telephone Support		1-888-999-ATEN ext 4988

When you contact us, please have the following information ready beforehand:

- ◆ Product model number, serial number, and date of purchase.
- ◆ Your computer configuration, including operating system, revision level, expansion cards, and software.
- ◆ Any error messages displayed at the time the error occurred.
- ◆ The sequence of operations that led up to the error.
- ◆ Any other information you feel may be of help.

CS19208 / CS19216 Connection Tables

The following tables indicate the relationship between the number of Primary View units and the number of computers that they control:

CS19208 (First Level) + CS19208 (Second Level)

PVs	Computers
1	1 - 8
2	8 -15
3	15 - 22
4	22 - 29
5	29 - 36
6	36 - 43
7	43 - 50
8	50 - 57
9	57 - 64

CS19208 (First Level) + CS19216 (Second Level)

PVs	Computers
1	1 - 8
2	8 -23
3	23 - 38
4	38 - 53
5	53 - 68
6	68 - 83
7	83 - 98
8	98 - 113
9	113 - 128

CS19216 (First Level) + CS19208 (Second Level)

PVs	Computers	PVs	Computers
1	1 - 16	10	72 - 79
2	16 - 23	11	79 - 86
3	23 - 30	12	86 - 93
4	30 - 37	13	93 - 100
5	37 - 44	14	100 - 107
6	44 - 51	15	107 - 114
7	51 - 58	16	114 - 121
8	58 - 65	17	121 - 128
9	65 - 72		

CS19216 (First Level) + CS19216 (Second Level)

PVs	Computers	PVs	Computers
1	1 - 16	10	136 - 151
2	16 - 31	11	151 - 166
3	31 - 46	12	166 - 181
4	46 - 61	13	181 - 196
5	61 - 76	14	196 - 211
6	76 - 91	15	211 - 226
7	91 - 106	16	226 - 241
8	106 - 121	17	241 - 256
9	121 - 136		

Specifications

Function		CS19208	CS19216	
Computer Connections	Direct	8	16	
	Max.	128 (via Cascade)	256 (via Cascade)	
Port Selection		OSD, Hotkey, Pushbutton, RS-232 Commands		
Connectors	Console Ports	KB	1 x USB Type A Female	
		Video	1 x DisplayPort Female 1 x HDMI Female	
		Mouse	1 x USB Type A Female	
		Speakers	2 x 3.5mm Audio Jack Female (Green; 1 x front, 1 x rear)	
	KVM Ports	KB / Mouse	8 x USB3.1 Gen1 Type B Female (Blue)	16 x USB3.1 Gen1 Type B Female (Blue)
		Video	8 x DisplayPort Female	16 x DisplayPort Female
		Speakers	8 x 3.5mm Audio Jack Female (Green)	16 x 3.5mm Audio Jack Female (Green)
	F/W Upgrade		1 x RJ11 Female (Black)	
	Power		1 x DC Jack	
	USB 3.1 Hub		2 x USB 3.1 Gen1 Type A Female (Blue; 2 x front)	
Switches	Port Selection	8 x Pushbutton	16 x Pushbutton	
	Reset	1 x Semi-recessed Pushbutton		
	F/W Upgrade	1 x Slide Switch		
LEDs	USB Link	8 (Green)	16 (Green)	
	On Line / Selected	8 (Orange)	16 (Orange)	
	Power	1 (Green)		
Emulation	Keyboard / Mouse	USB		
Video		DisplayPort: 4096 x 2160 @ 60Hz HDMI: 4096 x 2160 @ 60Hz		
Scan Interval		1–255 Seconds (Default: 5 secs)		
Power Consumption		DC12V:18.44W:136BTU	DC12V:26.66W:175BTU	
Environment	Operating Temp.	0–40°C		
	Storage Temp	-20–60°C		
	Humidity	0–80% RH, Non-condensing		
Physical Properties	Housing	Metal		
	Weight	3.11 kg (6.85 lb)	3.54 kg (7.8 lb)	
	Dimensions (L x W x H)	43.24 x 21.43 x 4.40 cm (17.02 x 8.44 x 1.73 in.)	43.24 x 21.43 x 4.40 cm (17.02 x 8.44 x 1.73 in.)	

Administrator Login Failure

If you are unable to perform an Administrator login (because the username/ password information has become corrupted, or you have forgotten it, for example), you can clear the login information with the following procedure:

1. Power off the CS19208 / CS19216 and remove its housing.
2. Short the jumper labeled J29.

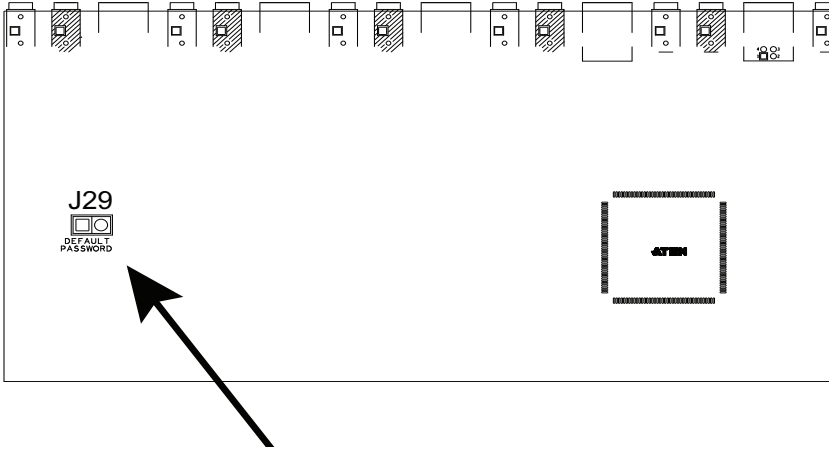

3. Power on the switch.
4. When the front panel LEDs flash, power off the switch.
5. Remove the jumper cap from J29.
6. Close the housing and start the CS19208 / CS19216 back up.
After you start back up, you can use the default login procedure (see *OSD Login*, page 29) to login.

Factory Default Hotkeys and Settings

Setting	Default
OSD Hotkey	[Scroll Lock] [Scroll Lock]
Invoking HSM Hotkey	[Number Lock] [-]
Auto Scan Interval	5 seconds
Mouse Emulation	Enabled
EDID Mode	DisplayPort Monitor's EDID
Beeper	Enabled
Video DynaSync	Enabled

Limited Warranty

ATEN warrants its hardware in the country of purchase against flaws in materials and workmanship for a Warranty Period of two [2] years (warranty period may vary in certain regions/countries) commencing on the date of original purchase. This warranty period includes the LCD panel of ATEN LCD KVM switches. Select products are warranted for an additional year (see *A+ Warranty* for further details). Cables and accessories are not covered by the Standard Warranty.

What is covered by the Limited Hardware Warranty

ATEN will provide a repair service, without charge, during the Warranty Period. If a product is defective, ATEN will, at its discretion, have the option to (1) repair said product with new or repaired components, or (2) replace the entire product with an identical product or with a similar product which fulfills the same function as the defective product. Replaced products assume the warranty of the original product for the remaining period or a period of 90 days, whichever is longer. When the products or components are replaced, the replacing articles shall become customer property and the replaced articles shall become the property of ATEN.

To learn more about our warranty policies, please visit our website:
<http://www.aten.com/global/en/legal/policies/warranty-policy/>

A

- Activate Beeper 41
- ADM 39
- Auto Scanning 45
 - Invoking Auto Scan 50
 - Pausing Auto Scan 50
 - Scan Duration 38
 - Stopping 50

B

- Beeper
 - Activate 41
 - Control 52
 - Hotkey Control 52, 53

BRC 44

Broadcast Mode 44

C

- Clear the Name List 41
- Components 6
- Computer Connection Tables 93

D

desktop mounting 12

E

Edit Port Names 41

F

- F1: GOTO 35
- F2: LIST 36
- F3: SET 37
- F4: ADM 39
- F5: SKP 43
- F6: BRC 44
- F7: SCAN 45
- F8: LOUT 46
- Firmware upgrade
 - OSD setting 42
 - port 80
 - recovery 85

G

GOTO 35

H

- Hot Plugging 27
 - Console Ports 27
 - KVM ports 27
- Hotkey
 - Beeper Control 52, 53

- Command Mode 38
- OSD 37
- Selecting the Active Port 49

- Hotkey Mode
 - exiting 48
- Hotkey Port Control 47

I

- Installation
 - two stage 19

K

- Keyboard Emulation
 - Mac 59
 - Sun 60

L

- LIST 36
- Logout 46
- Logout Timeout 40
- LOUT 46

M

- mounting
 - desktop 12
 - rack 12

O

- Online
 - Registration iii
- OSD
 - Functions 34
 - Hotkey 32, 37
 - Logout 46
 - Main Screen 31, 32
 - Main Screen Headings 33
 - Navigation 33
 - Overview 31
 - Password 31

P

- Password 31
- Pause 45
- Port ID
 - Display Duration 38
 - Display Mode 38
 - Display Position 37
 - Numbering 28
- Port Names 41
- Port Selection 28

Manual 28
ports
 quick view 41
 set operating system 42
Powering Off and Restarting 29

Q

quick view ports 41

R

Rack Mounting
 Safety information 91
rack mounting 12
 front 13
 rear 15

Requirements

 Operating Systems 5
 OS Support 5

Restore Default Values 41

RoHS ii

S

Safety Instructions
 General 89

Rack Mounting 91
SCAN 45
Scan Duration 38
SCAN/SKIP MODE 38
Screen Blanker 38
Selecting the Active Port 49
SET 37

 Accessible Ports 40
 Logout Timeout 40
 Quick View Ports 41

Skip Mode 43, 51
Specifications 94
stacking 12

T

Technical Support 92
Telephone support iii
Timeout 40
Two Stage Installation 19

U

User Notice iii
