



HDMI HDBaseT Receiver with Audio De-Embedding VE2812R User Manual



www.aten.com

EMC Information

FEDERAL COMMUNICATIONS COMMISSION INTERFERENCE

STATEMENT: This equipment has been tested and found to comply with the limits for a Class A digital device, pursuant to Part 15 of the FCC Rules. These limits are designed to provide reasonable protection against harmful interference when the equipment is operated in a commercial environment. This equipment generates, uses, and can radiate radio frequency energy and, if not installed and used in accordance with the instruction manual, may cause harmful interference to radio communications. Operation of this equipment in a residential area is likely to cause harmful interference in which case the user will be required to correct the interference at his own expense.

FCC Caution: Any changes or modifications not expressly approved by the party responsible for compliance could void the user's authority to operate this equipment.

CE Warning: Operation of this equipment in a residential environment could cause radio interference.

This device complies with Part 15 of the FCC Rules. Operation is subject to the following two conditions:

- (1) this device may not cause harmful interference, and
- (2) this device must accept any interference received, including interference that may cause undesired operation.

KCC Statement

유선 제품용 / A 급 기기 (업무용 방송 통신 기기)
이 기기는 업무용 (A 급) 전자파적합기기로서 판매자 또는 사용자는 이 점을 주의하시기 바라며, 가정 외의 지역에서 사용하는 것을 목적으로 합니다.

RoHS

This product is RoHS compliant.



User Information

Online Registration

Be sure to register your product at our online support center:

International	http://eservice.aten.com
---------------	-----------------------------------------------------------------

Telephone Support

For telephone support, call this number:

International	886-2-8692-6959
China	86-400-810-0-810
Japan	81-3-5615-5811
Korea	82-2-467-6789
North America	1-888-999-ATEN ext 4988 1-949-428-1111

User Notice

All information, documentation, and specifications contained in this manual are subject to change without prior notification by the manufacturer. The manufacturer makes no representations or warranties, either expressed or implied, with respect to the contents hereof and specifically disclaims any warranties as to merchantability or fitness for any particular purpose. Any of the manufacturer's software described in this manual is sold or licensed as *is*. Should the programs prove defective following their purchase, the buyer (and not the manufacturer, its distributor, or its dealer), assumes the entire cost of all necessary servicing, repair and any incidental or consequential damages resulting from any defect in the software.

The manufacturer of this system is not responsible for any radio and/or TV interference caused by unauthorized modifications to this device. It is the responsibility of the user to correct such interference.

The manufacturer is not responsible for any damage incurred in the operation of this system if the correct operational voltage setting was not selected prior to operation. PLEASE VERIFY THAT THE VOLTAGE SETTING IS CORRECT BEFORE USE.

Package Contents

1 VE2812R HDMI HDBaseT Receiver with Audio De-Embedding
1 RS-232 Terminal Block
4 Foot Pads
1 Power Adapter
1 User Instructions

Note: Make sure that all of the components are present and in good order. If anything is missing or was damaged in shipping, contact your dealer.

Table of Contents

EMC Information	ii
RoHS	ii
User Information	iii
Online Registration	iii
Telephone Support	iii
User Notice	iii
Package Contents	iv
About this Manual	vii
Conventions	viii
Product Information	viii

1. Introduction

Overview	1
Features	2
Planning the Installation	3
Requirements	3
Considerations	3
Compatible Products	3
Components	4
Front View	4
Rear View	5
LED Display	6

2. Hardware Setup

Mounting the VE2812R Unit	7
Wall Mounting	7
Rack Mounting	7
Connecting the VE2812R Unit	8
RS-232 Channel Transmission	10

3. Operation

RS-232 Serial Transmission	11
Bypass	11
Command	11
Command to control VE28128R	11
Command to control VE2812T	12
Long Reach Mode	13

Appendix

Safety Instructions	15
General	15
Rack Mounting	17
Technical Support	18

International	18
North America	18
Specifications	19
Limited Warranty	21

About this Manual

This user manual is provided to help you get the most from the VE2812R unit. It covers all aspects of installation, configuration, and operation. An overview of the information found in the manual is provided below.

Chapter 1, Introduction introduces you to the VE2812R. Its purpose, features, installation considerations, and panel components are presented and described.

Chapter 2, Hardware Setup describes the steps that are necessary to quickly and safely set up your installation.

Chapter 3, Operation explains the limitations, and how to adjust audio channel using the a switch and RS-232 commands.

An Appendix provides a list of safety instructions and precautions, contact information for ATEN technical support, product specifications, and other technical information.

Note:

- ◆ Read this manual thoroughly and follow the installation and operation procedures carefully to prevent any damage to the unit or any connected devices.
 - ◆ ATEN regularly updates its product documentation for new features and fixes. For an up-to-date VE2812R documentation, visit <http://www.aten.com/global/en/>
-

Conventions

This manual uses the following conventions:

- `Monospaced` Indicates text that you should key in.
- [] Indicates keys you should press. For example, [Enter] means to press the **Enter** key. If keys need to be chorded, they appear together in the same bracket with a plus sign between them: [Ctrl+Alt].
1. Numbered lists represent procedures with sequential steps.
- ◆ Bullet lists provide information, but do not involve sequential steps.
- Indicates selecting the option (on a menu or dialog box, for example), that comes next. For example, Start → Run means to open the *Start* menu, and then select *Run*.
-  Indicates critical information.

Product Information

For information about all ATEN products and how they can help you connect without limits, visit ATEN on the Web or contact an ATEN Authorized Reseller. Visit ATEN on the Web for a list of locations and telephone numbers:

International	http://www.aten.com
North America	http://www.aten-usa.com

Chapter 1

Introduction

Overview

ATEN VE2812R is a high-quality HDBaseT HDMI receiver featuring Audio De-Embedding function. Powered by HDBaseT™ technology, the VE2812R can receive 4K HDMI signals up to 100 m over a single Cat 5e/6/6a or ATEN 2L-2910 Cat 6 cable. With HDBaseT Long Reach Mode enabled, it can deliver HDMI signals up to a maximum range of 150 meters @ 1080p.

The VE2812R is HDCP2.2, HDMI1.4 compatible and guarantees reliable transmission of high-quality uncompressed HDMI signals, supporting 3D, 1080p/36bits Deep Color, 4K and embedded HD lossless audio formats. In addition, the VE2812R's built-in Audio De-Embedded function delivers S/PDIF Coaxial or Stereo audio signals extracted from HDMI interface to an audio system that is separated from the display.

The VE2812R is designed for use in meeting rooms or digital education environments where high video quality is required. Take advantage of this HDMI Extender to extend and display crystal clear, High-Definition digital signals in a reliable and efficient manner.

More, VE2812R can carry on IR/RS232 from VE2812T. The VE2812R is recommend to be deployed in pair with the VE2812T. Users could remotely control the VE2812T unit through RS-232 command mode via input port switching.

Features

- ◆ Superior video quality
 - ◆ 4K HDMI up to 100 m via a single Cat 5e/6/6a or ATEN 2L-2910 Cat 6 cable
 - ◆ 1080p up to 150 m via a single Cat 5e/6 cable in HDBaseT Long Reach Mode
- ◆ HDMI 1.4 (3D, Deep Color, 4K); HDCP 2.2 compliant
- ◆ Supports Audio EDID Switching (2ch Stereo, 5.1 ch Surround sound, and AUTO)
- ◆ Supports Audio De-Embedding - extracts audio stream from an HDMI source and delivers as a separate audio from HDMI, Coaxial S/PDIF, or Stereo audio output.
- ◆ Features RS-232 Serial Communication Switch - Command mode and Bypass mode to meet application requirements
- ◆ Supports bi-directional IR signal transmission - IR way IR protocol delivery by one IR port; IR transmission is processed one direction at a time
- ◆ Firmware upgradable
- ◆ Built-in 8KV / 15KV ESD protection
- ◆ Plug-and-play
- ◆ Rack-mountable using the VE-RMK1U

Planning the Installation

Requirements

Prepare the following before installing the VE2812R unit:

- ◆ 1 HDMI display device
- ◆ 1 Cat 5e/6/6a or ATEN 2L-2910 Cat 6 cable

Considerations

- ◆ To ensure video quality, use a Cat 5e/6/6a cable.

Note:For best results, ATEN recommends using the ATEN 2L-2910 Cat 6 cable.

- ◆ The maximum transmission distance varies at different parts of the transmission:

Connection	Interface	Max. Distance
The VE2812R to a compatible ATEN Video Extender Transmitter	Cat 5e/6/6a	100 m / 150 m (up to 1080p in Long Reach Mode)
The VE2812R to a display	HDMI	5 m

Compatible Products

The VE2812R is designed to work with VE2812T / VE2812EUT / VE2812UST, and also compatible with a wide range of ATEN video splitters, video switches, video extender transmitters, and video converters. Visit our official web site for more details.

Components

Front View

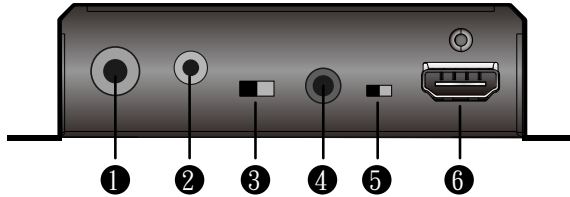

No.	Component	Description
1	Audio Out (Coaxial)	Connects to the Audio In (Coaxial) port on a speaker.
2	Audio Out (Stereo)	Connects to the Audio In (Stereo) port on a speaker.
3	Audio Channel Switch	Use the switch to set the audio channel to 2.1 ch, 5.1 ch, or auto.
4	IR Port	Connects to an IR transmitter/receiver.
5	HDMI Audio Out Switch	To mute the audio on the connected HDMI display, put the HDMI Audio Out Switch to OFF .
6	HDMI Video Out	Connects to the HDMI In Port on the display device.

Rear View

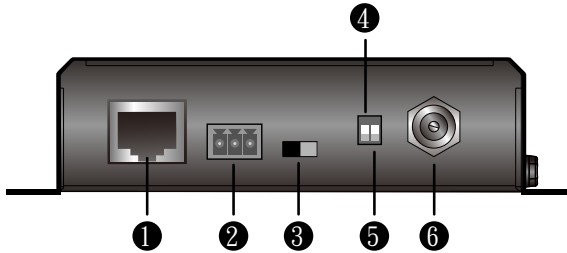

No.	Component	Description
1	HDBaseT In	Connects to the HDBaseT Output port on a compatible ATEN video transmitter via a CAT 6a/ ATEN 2L-2910 cable.
2	RS-232 Serial Port	Connects to an RS-232 main controller, such as a PC or Control system.
3	RS-232 Serial Communication Switch	Sets the RS-232 serial interface for signal Bypass or Command . For details, see page 11.
4	Long Reach Mode Switch	Put the switch to ON to enable the Long Reach Mode. For more details on Long Reach Mode, see page 13.
5	Firmware Upgrade Switch	This port is reserved for ATEN Technical Support. If you would like to do a firmware upgrade yourself, please contact your dealer.
6	Power Jack	Connects to the Power Adapter.

LED Display

You can find the unit's LEDs on the top and front panel as illustrated below. See the table below for details on LED indication.

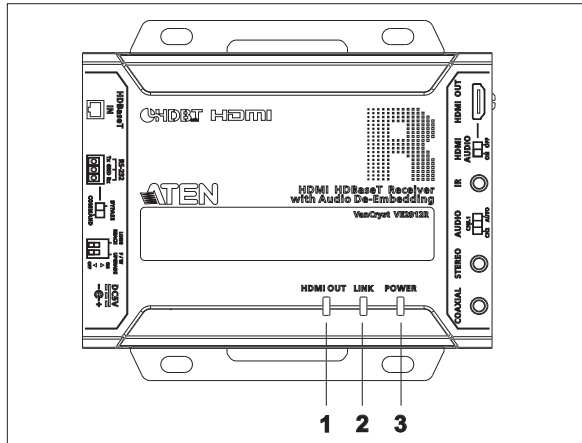

No.	LED	Indication	Description
1	HDMI Out Status LED	Lights orange	Video display is normal with HDCP key.
		Blinks orange	Video display is normal without HDCP key.
		Off	Video signal dropped.
2	Link LED	Lights orange	The transmission to the display device is stable.
		Off	The transmission to the display device is unstable.
3	Power LED	Lights green	The unit is powered on.
		Off	The unit is powered off.

Note:

- ◆ The Power, Link LED and HDMI Out Status LED blink at the same time to indicate that the firmware upgrade is in progress.

Chapter 2

Hardware Setup



1. Please review the safety information regarding the placement of this device in Safety Instructions, page 15.
2. Do not power on the VE2812R until all the necessary hardware is connected.

Mounting the VE2812R Unit

You can mount the VE2812R to the wall or on a rack.

Wall Mounting

Secure or hang the VE2812R unit to the wall using the built-in mounting brackets.

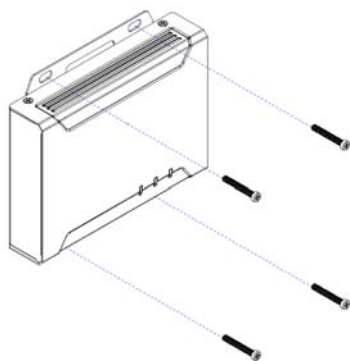

Rack Mounting

Use the VE-RMK 1U Rack Mount Kit to rack-mount the VE2812R. For more information about this accessory, go to <https://www.aten.com/global/en/products/professional-audiovideo/accessories/ve-rmk1u/>

Connecting the VE2812R Unit

Follow the steps below to connect the VE2812R to an HDMI-enabled display source, a compatible ATEN Video Transmitter, and other controls as required.

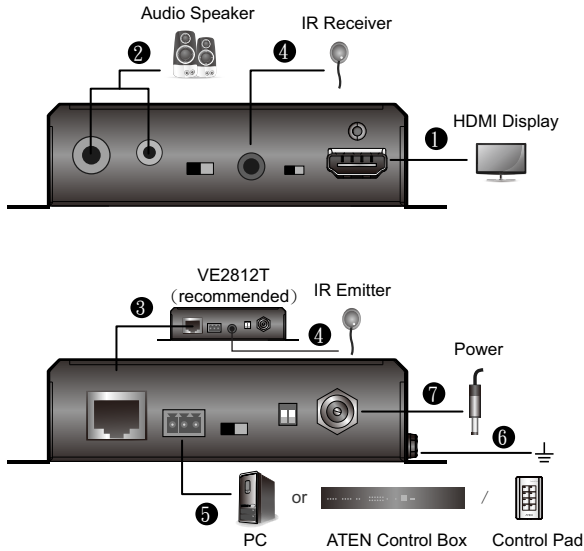

1. Connect an HDMI-enabled display to the VE2812R's HDMI Out Port.
2. Follow the steps below to set up your audio output.
 - a) To use an independent speaker, connect the speaker to the VE2812R's Audio Out Port (Coaxial or Stereo) using an appropriate audio cable.
 - b) Depending on the interface of your chosen audio output device, adjust the audio signal using the Audio Channel Switch.

Audio Interface	Audio Channel Switch	Description
Stereo	2 ch	Sets the audio output to channel 2.
Coaxial	5.1 ch	Sets the audio output to channel 5.1.
HDMI	Auto	Detects the supported audio channel of the connected HDMI display.

Note: Stereo audio will be mute if the channel is set to **CH5.1**.

- c) To mute the audio on the connected HDMI display, put the HDMI Audio Switch to **OFF**.
3. Connect the VE2812R's HDBaseT In Port to a video transmitter's HDBaseT Out Port using a Cat 6a/ATEN 2L-2910 cable.

Note:ATEN recommends pairing the VE2812R with VE2812T / VE2812EUT / VE2812UST.

4. (Optional) To bypass IR signals to remotely control a device (e.g. blu-ray disc) connected to the video transmitter, connect an IR receiver to the VE2812R's IR port and an IR emitter to the VE2812T's IR port.

Note:To purchase an IR receiver and an IR remote control, contact your local sales representative for more information.

5. (Optional) You can use the RS-232 serial port to do one of the following:
- ◆ To control the VE2812T using an ATEN Control System/Control Pad, connect a Control Box/Control Pad to the VE2812R's RS-232 Serial port and then put the RS-232 Serial Communication Switch to **Command**.
 - ◆ To bypass RS-232 serial control signals to a PC or a serial device, connect the PC or serial device (e.g. touch pad) to the VE2812R's RS-232 Serial port and put the RS-232 Serial Communication Switch to **Bypass**.
6. Ground the devices connected to the VE2812R to prevent damages from power surges or static electricity.
7. Plug the power cord into the VE2812R's power jack.

RS-232 Channel Transmission

You can manage the VE2812R via RS-232 serial devices, such as computers or bar code scanners. The RS-232 signal transmission flow can be illustrated as follows:

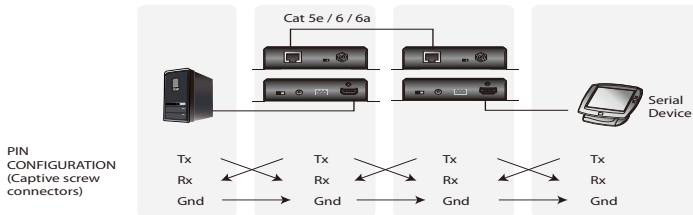

From a source device, the RS-232 signal is transmitted (Tx) to the VE2812R receiving (Rx) unit; the a compatible ATEN Video Receiver transmits (Tx) signals to the display device (Rx).

You can set the VE2812R to either bypass serial data or to receive RS-232 commands. By default, the VE2812R is set to bypass serial data. To set the unit to receive RS-232 commands, press the Input Switch pushbutton for 5 seconds. For details on RS-232 commands, see *RS-232 Serial Transmission*, page 11.

Chapter 3 Operation

RS-232 Serial Transmission

The RS-232 Serial Transmission allows you to choose whether to bypass serial data or to remotely control the VE2812T using commands depending on your installation.

Bypass

RE-232 serial data is bypassed from the controller PC or Pad to other connected devices.

Command

Command to control VE2812R

To control VE2812R please use the commands below.

Task	Command
	Control
Mute the HDMI display sound	mute HDMI audio on
Unmute the HDMI display sound	mute HDMI audio off

Note:

- ◆ In order for the above two commands to work, the HDMI Audio Out Switch must be switched to **OFF**.

Mute the stereo and coaxial sound	mute audio on
Unmute the stereo and coaxial sound	mute audio off

Note:

- ◆ Press **[Enter]** to execute a command.
-

Command to control VE2812T

You can change the input mode of VE2812T using RS-232 commands. Refer to the table below for a list of available tasks and the corresponding commands. For example, to enable automatic switching, type **swmode next** and then press **[Enter]**.

Task	Command		
	Control	Input	Port
Enable automatic input switching	swmode next	N/A	N/A
Disable automatic input switching	swmode off	N/A	N/A
Set the unit to the HDMI mode	sw	i	01
Set the unit to the VGA mode	sw	i	02
View the current input mode settings	read	N/A	N/A

Note:

- ◆ Press **[Enter]** to execute a command.

You can simply switch RS-232 mode between **Command** / **Bypass** by clicking the RS-232 Serial Communication Switch listed below.

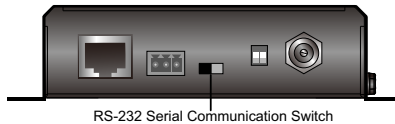

Note: By default, the VE2812R is set to **Bypass** serial data.

Long Reach Mode

Long Reach Mode is a modulation that extends the transmission distance up to 150 m using a Cat 5e/6 cable while compromising the maximum frame rate to 1080p, 24 bpp, 60 Hz via a single Cat 5e/6 cable. To enable Long Reach Mode, put the HDBaseT Long Reach Mode Switch to **ON** at either the transmitter or the connected receiver.



Note: When Long Reach Mode is enabled, the VE2812R will not be able to transmit 4K signals, in which case, the output display will be blank.

This Page Intentionally Left Blank

Safety Instructions

General

- ◆ This product is for indoor use only.
- ◆ Read all of these instructions. Save them for future reference.
- ◆ Follow all warnings and instructions marked on the device.
- ◆ Do not place the device on any unstable surface (cart, stand, table, etc.). If the device falls, serious damage will result.
- ◆ Do not use the device near water.
- ◆ Do not place the device near, or over, radiators or heat registers.
- ◆ The device cabinet is provided with slots and openings to allow for adequate ventilation. To ensure reliable operation, and to protect against overheating, these openings must never be blocked or covered.
- ◆ The device should never be placed on a soft surface (bed, sofa, rug, etc.) as this will block its ventilation openings. Likewise, the device should not be placed in a built in enclosure unless adequate ventilation has been provided.
- ◆ Never spill liquid of any kind on the device.
- ◆ Unplug the device from the wall outlet before cleaning. Do not use liquid or aerosol cleaners. Use a damp cloth for cleaning.
- ◆ The device should be operated from the type of power source indicated on the marking label. If you are not sure of the type of power available, consult your dealer or local power company.
- ◆ The device is designed for IT power distribution systems with 230V phase-to-phase voltage.
- ◆ To prevent damage to your installation it is important that all devices are properly grounded.
- ◆ The device is equipped with a 3-wire grounding type plug. This is a safety feature. If you are unable to insert the plug into the outlet, contact your electrician to replace your obsolete outlet. Do not attempt to defeat the purpose of the grounding-type plug. Always follow your local/national wiring codes.
- ◆ Do not allow anything to rest on the power cord or cables. Route the power cord and cables so that they cannot be stepped on or tripped over.

- ◆ If an extension cord is used with this device make sure that the total of the ampere ratings of all products used on this cord does not exceed the extension cord ampere rating. Make sure that the total of all products plugged into the wall outlet does not exceed 15 amperes.
- ◆ To help protect your system from sudden, transient increases and decreases in electrical power, use a surge suppressor, line conditioner, or uninterruptible power supply (UPS).
- ◆ Position system cables and power cables carefully; Be sure that nothing rests on any cables.
- ◆ Never push objects of any kind into or through cabinet slots. They may touch dangerous voltage points or short out parts resulting in a risk of fire or electrical shock.
- ◆ Do not attempt to service the device yourself. Refer all servicing to qualified service personnel.
- ◆ If the following conditions occur, unplug the device from the wall outlet and bring it to qualified service personnel for repair.
 - ◆ The power cord or plug has become damaged or frayed.
 - ◆ Liquid has been spilled into the device.
 - ◆ The device has been exposed to rain or water.
 - ◆ The device has been dropped, or the cabinet has been damaged.
 - ◆ The device exhibits a distinct change in performance, indicating a need for service.
 - ◆ The device does not operate normally when the operating instructions are followed.
- ◆ Only adjust those controls that are covered in the operating instructions. Improper adjustment of other controls may result in damage that will require extensive work by a qualified technician to repair.

Rack Mounting

- ◆ Before working on the rack, make sure that the stabilizers are secured to the rack, extended to the floor, and that the full weight of the rack rests on the floor. Install front and side stabilizers on a single rack or front stabilizers for joined multiple racks before working on the rack.
- ◆ Always load the rack from the bottom up, and load the heaviest item in the rack first.
- ◆ Make sure that the rack is level and stable before extending a device from the rack.
- ◆ Use caution when pressing the device rail release latches and sliding a device into or out of a rack; the slide rails can pinch your fingers.
- ◆ After a device is inserted into the rack, carefully extend the rail into a locking position, and then slide the device into the rack.
- ◆ Do not overload the AC supply branch circuit that provides power to the rack. The total rack load should not exceed 80 percent of the branch circuit rating.
- ◆ Make sure that all equipment used on the rack – including power strips and other electrical connectors – is properly grounded.
- ◆ Ensure that proper airflow is provided to devices in the rack.
- ◆ Ensure that the operating ambient temperature of the rack environment does not exceed the maximum ambient temperature specified for the equipment by the manufacturer.
- ◆ Do not step on or stand on any device when servicing other devices in a rack.

Technical Support

International

- ◆ For online technical support – including troubleshooting, documentation, and software updates: <http://support.aten.com>
- ◆ For telephone support, see *Telephone Support*, page iii:

North America

Email Support		support@aten-usa.com
Online Technical Support	Troubleshooting Documentation Software Updates	http://www.aten-usa.com/support
Telephone Support		1-888-999-ATEN ext 4988

When you contact us, please have the following information ready beforehand:

- ◆ Product model number, serial number, and date of purchase
- ◆ Your computer configuration, including operating system, revision level, expansion cards, and software
- ◆ Any error messages displayed at the time the error occurred
- ◆ The sequence of operations that led up to the error
- ◆ Any other information you feel may be of help

Specifications

Function	Specifications	
Video Output		
Interfaces	1 x HDMI Type A Female (Black)	
Impedance	HDMI: 100 Ω	
Video		
Max. Data Rate	10.2 Gbps (3.4 Gbps per lane)	
Max. Pixel Clock	340 MHz	
Compliance	HDMI (3D, Deep Color, 4K)	
	HDCP Compatible	
	Consumer Electronics Control (CEC)	
Max. Resolutions / Distances	HDMI: <ul style="list-style-type: none"> ◆ Up to 4k @70m (Cat 5e/6) / 100m (Cat 6a/ATEN 2L-2910 Cat6) ◆ Up to 1080p @100m (Cat 5e/6/6a) 4k supported: <ul style="list-style-type: none"> ◆ 4096 x 2160 / 3840 x 2160 @60Hz (4:2:0) ◆ 4096 x 2160 / 3840 x 2160 @30Hz (4:4:4) 	
Audio		
Output	1 x HDMI Type A Female (Black) 1 x Mini Stereo Jack Female (Green) 1 x SPDIF Coaxial Female (Orange)	
Connectors		
Unit To Unit	1 x RJ-45 Female	
Power	1 x DC Jack (Black) with locking	
Control		
RS-232	Connectors	1 x Terminal Block, 3 Pole, Type: DTE
	Baud Rate	19200 bps
	Data Bits	8
	Stop Bits	1, no parity and flow control
IR	1 x Mini Stereo Jack Female (Black)	
Power Consumption	DC5V:4.98W:43BTU	

Function	Specifications
Switches	
HDMI Mute	1 x Slide Switch - ON/OFF
Audio EDID Selection	1 x Slide Switch - 2ch/5.1ch/AUTO
RS-232 Selection	1 x Slide Switch - RS-232 Bypass/Command mode
Long Reach Mode Switch	1 Slide Switch - ON/OFF
Firmware Upgrade	1 Slide Switch - ON/OFF
Environmental	
Operating Temperature	0 - 40°C
Storage Temperature	-20 - 60°C
Humidity	0 x 80% RH, Non-Condensing
Physical Properties	
Housing	Metal
Weight	0.46 Kg (1.01 lb)
Dimensions (L x W x H) with Bracket	14.53 x 12.30 x 3.00 cm (5.72 x 4.84 x 1.18 in.)
Dimensions (L x W x H) without Bracket	13.60 x 10.10 x 2.90 cm (5.35 x 3.98 x 1.14 in.)

Limited Warranty

ATEN warrants its hardware in the country of purchase against flaws in materials and workmanship for a Warranty Period of two [2] years (warranty period may vary in certain regions/countries) commencing on the date of original purchase. This warranty period includes the LCD panel of ATEN LCD KVM switches. Select products are warranted for an additional year (see *A+ Warranty* for further details). Cables and accessories are not covered by the Standard Warranty.

What is covered by the Limited Hardware Warranty

ATEN will provide a repair service, without charge, during the Warranty Period. If a product is defective, ATEN will, at its discretion, have the option to (1) repair said product with new or repaired components, or (2) replace the entire product with an identical product or with a similar product which fulfills the same function as the defective product. Replaced products assume the warranty of the original product for the remaining period or a period of 90 days, whichever is longer. When the products or components are replaced, the replacing articles shall become customer property and the replaced articles shall become the property of ATEN.

To learn more about our warranty policies, please visit our website:
<http://www.aten.com/global/en/legal/policies/warranty-policy>

This Page Intentionally Left Blank