



# ATEN Control System User Manual



[www.aten.com](http://www.aten.com)

# Preface

## EMC Information

---

### FEDERAL COMMUNICATIONS COMMISSION INTERFERENCE STATEMENT

This equipment has been tested and found to comply with the limits for a Class A digital device, pursuant to Part 15 of the FCC Rules. These limits are designed to provide reasonable protection against harmful interference when the equipment is operated in a commercial environment. This equipment generates, uses, and can radiate radio frequency energy and, if not installed and used in accordance with the instruction manual, may cause harmful interference to radio communications. Operation of this equipment in a residential area is likely to cause harmful interference in which case the user will be required to correct the interference at his own expense.

**FCC Caution:** Any changes or modifications not expressly approved by the party responsible for compliance could void the user's authority to operate this equipment.

**Warning:** Operation of this equipment in a residential environment could cause radio interference.

### KCC Statement

유선 제품용 / A 급 기기 ( 업무용 방송 통신 기기 )

이 기기는 업무용 ( A 급 ) 전자파적합기기로서 판매자 또는 사용자는 이 점을 주의하시기 바라며 , 가정 외의 지역에서 사용하는 것을 목적으로 합니다 .

## RoHS

---

This product is RoHS compliant.

## Safety

---

This product has been classified as Information Technology Equipment.



---

## User Information

---

### Online Registration

Be sure to register your product at our online support center:

International	<a href="http://eservice.aten.com">http://eservice.aten.com</a>
---------------	---

### Telephone Support

For telephone support, call this number:

International	886-2-8692-6959
China	86-400-810-0-810
Japan	81-3-5615-5811
Korea	82-2-467-6789
North America	1-888-999-ATEN ext 4988 1-949-428-1111

### User Notice

All information, documentation, and specifications contained in this manual are subject to change without prior notification by the manufacturer. The manufacturer makes no representations or warranties, either expressed or implied, with respect to the contents hereof and specifically disclaims any warranties as to merchantability or fitness for any particular purpose. Any of the manufacturer's software described in this manual is sold or licensed *as is*. Should the programs prove defective following their purchase, the buyer (and not the manufacturer, its distributor, or its dealer), assumes the entire cost of all necessary servicing, repair and any incidental or consequential damages resulting from any defect in the software.

The manufacturer of this system is not responsible for any radio and/or TV interference caused by unauthorized modifications to this device. It is the responsibility of the user to correct such interference.

The manufacturer is not responsible for any damage incurred in the operation of this system if the correct operational voltage setting was not selected prior to operation. PLEASE VERIFY THAT THE VOLTAGE SETTING IS CORRECT BEFORE USE.

## Package Contents

---

### **VK2100**

The VK2100 package consists of:

- ◆ 1 VK2100 ATEN Control Box
- ◆ 1 Rack Mount Kit
- ◆ 9 Terminal Blocks
- ◆ 1 Power Cord
- ◆ 1 User Instructions\*

### **VK1100**

The VK1100 package consists of:

- ◆ 1 VK1100 ATEN Compact Control Box
- ◆ 4 Terminal Blocks
- ◆ 1 Power Cord
- ◆ 1 User Instructions\*

---

#### **Note:**

- ◆ Read this manual thoroughly and follow the installation and operation procedures carefully to prevent any damage to the ATEN Control Box and other connected devices.
  - ◆ The VK2100 product firmware may have been updated with new features after the release of this manual. For an up-to-date VK2100 user manual, visit <http://www.aten.com/global/en/>
-



# Table of Contents

---

## Preface

EMC Information . . . . .	ii
Safety . . . . .	ii
User Information . . . . .	iii
Telephone Support . . . . .	iii
Package Contents . . . . .	iv
VK2100 . . . . .	iv
VK1100 . . . . .	iv
Table of Contents . . . . .	v
About this Manual . . . . .	ix
Conventions . . . . .	x
Terminology . . . . .	x
Product Information . . . . .	x

## 1. Introduction

Overview . . . . .	1
Benefits . . . . .	3
Intelligent Control . . . . .	3
Features . . . . .	5
ATEN Configurator (VK6000) . . . . .	6
ATEN Control System App . . . . .	6
ATEN Keypads (8-button VK108US and 12-button VK112EU) . . . . .	7
Requirements . . . . .	8
Hardware Devices . . . . .	8
Accessories . . . . .	9

## 2. Hardware Setup

ATEN Control Box . . . . .	11
Panel Components . . . . .	11
VK2100 Front View . . . . .	11
VK2100 Rear View . . . . .	13
VK1100 Front View . . . . .	14
VK1100 Rear View . . . . .	15
Rack Mounting the ATEN Control Box . . . . .	16
VK2100 . . . . .	16
VK1100 . . . . .	17
Control Box Connections . . . . .	19
12VDC Power Output . . . . .	22
Relay . . . . .	26
IR / Serial . . . . .	27

One IR Transmitter .....	28
Two IR Transmitters .....	28
Digital I/O .....	29
RS-232 .....	31
RS-232 / 422 / 485 .....	32
Ethernet .....	33
ATEN Expansion Box .....	34
ATEN Keypad .....	35
Installation .....	36
Component .....	40
Layout Examples .....	41
VK108US .....	41
VK112EU .....	41

### 3. Browser Operation

Overview .....	43
Logging In .....	43
Dashboard .....	44
Settings .....	45
Licenses for Mobile Control .....	47
Storage .....	48
Access Key .....	49
Monitor .....	50
Network .....	51
Connections .....	52
Schedule .....	53
Security .....	54

### 4. ATEN Configurator (VK6000)

Overview .....	55
Installation .....	55
Getting Started Tasks .....	58
Main Page .....	60
Menu Bar .....	61
Project .....	67
Device .....	68
Adding Devices to ATEN Configurator .....	69
The Device Configuration List .....	70
Left Sidebar .....	71
Library .....	72
Device Library .....	73
Properties .....	74
Design .....	82

Select Viewer .....	83
Left Sidebar .....	84
Right Sidebar .....	84
Keypad .....	85
Page Overview .....	86
Edit .....	87
Windows OS Button Limitation .....	88
Page Objects .....	89
Properties .....	89
Button / Slider Bar Action .....	98
Adding Commands .....	100
Advanced Options .....	104
Layering Images .....	116
Graphic Library .....	117
Background Color .....	117
Button .....	117
Icon .....	118
Device Interface .....	118
Library .....	119
Flag .....	120
Monitor .....	122
Condition & Action Overview .....	122
Creating an If Monitor .....	125
Creating a Switch Monitor .....	130
Creating a Bypass Monitor .....	133
Macro .....	134
Scheduled Events .....	136
Synced Variables .....	137
For Devices that Return Feedback Messages .....	137
Upload .....	142
Uploading Viewers to Control Boxes .....	143
Viewing Control Box Information .....	144

## 5. ATEN Database Generator

Overview .....	145
My Library .....	146
Managing My Library .....	148
Edit / Add New Device .....	149
Text Command Tools .....	151
ATEN Library .....	163

## 6. Remote PC Control Using ControlAssist

Overview .....	165
----------------	-----

Specifications . . . . .	165
Setting Up Remote PC Control . . . . .	167
Installing ControlAssist to a Computer . . . . .	167
Adding the Computer to the Control System. . . . .	169
Configuring a Control Interface . . . . .	171
Supported PC Control Actions . . . . .	174

## 7. ATEN Control System App

Overview . . . . .	177
Installing the App . . . . .	177
ATEN Control System App . . . . .	178
Demo . . . . .	179
WinViewer1 / iPad / Android1 . . . . .	179
Demo. . . . .	180
Welcome . . . . .	182
Edit Viewer Profile . . . . .	183
Manage LAN Device . . . . .	184
Controller. . . . .	185
Set Password . . . . .	187
Log Report . . . . .	188
Report History . . . . .	189
Information . . . . .	190
Download Viewer Profile . . . . .	191
Downloading Profiles . . . . .	192

## Appendix

Safety Instructions . . . . .	193
Rack Mounting . . . . .	195
Technical Support . . . . .	196
Datapoint Types . . . . .	197
Specifications . . . . .	200
VK2100 . . . . .	200
VK1100 . . . . .	202
Limited Warranty. . . . .	204

## About this Manual

---

This User Manual is provided to help you get the most from your ATEN Control System. It covers all aspects of installation, configuration and operation. An overview of the information found in the manual is provided below.

**Chapter 1, Introduction,** introduces you to the ATEN Control System. Its purpose, features and benefits are presented, and the VK1100 and VK2100's front and back panel components are described.

**Chapter 2, Hardware Setup,** provides the necessary steps to setup the ATEN Control System installation, including how to wire the different types of hardware connections.

**Chapter 3, Browser Operation,** provides a complete description of the Browser Graphical User Interface (GUI) and how to use it to remotely configure parts of the ATEN Control System installation.

**Chapter 4, ATEN Configurator (VK6000),** provides a complete description of the VK6000 software and how to use it to configure and operate the ATEN Control System.

**Chapter 5, ATEN Database Generator,** provides a complete description of the Database Generator software and how to use it to configure new devices to add to the VK6000 device library.

**Chapter 6, Remote PC Control,** explains how to set up your computer for remote control from a license device and provide a complete description of the supported control actions.

**Chapter 7, ATEN Control System App,** provides a complete description of the ATEN mobile app and how to use it to operate devices connected to the ATEN Control System.

**An Appendix,** provides specifications and other technical information regarding the ATEN Control System.

## Conventions

---

This manual uses the following conventions:

- `Monospaced` Indicates text that you should key in.
- [ ] Indicates keys you should press. For example, [Enter] means to press the **Enter** key. If keys need to be chorded, they appear together in the same bracket with a plus sign between them: [Ctrl+Alt].
- 1. Numbered lists represent procedures with sequential steps.
- ◆ Bullet lists provide information, but do not involve sequential steps.
- Indicates selecting the option (on a menu or dialog box, for example), that comes next. For example, Start → Run means to open the *Start* menu, and then select *Run*.
-  Indicates critical information.

## Terminology

---

Terminology	Description
Control Box or ATEN Controller	Used without indicating model numbers to refer to all models of ATEN Control Box, including the VK2100 Control Box and the VK1100 Compact Control Box. A model number is indicated to refer to a specific model.
Viewer	A Viewer is a software interface created using ATEN Configurator and to be used on mobile devices to control devices managed by the Control Box.
Profile or Project Profile	A Profile or Project Profile is a file generated by ATEN Configurator that contains configurations of devices managed by the Control Box and the control interfaces (Viewers) to be used on mobile devices.

## Product Information

---

For information about all ATEN products and how they can help you connect without limits, visit ATEN on the Web or contact an ATEN Authorized Reseller. Visit ATEN on the Web for a list of locations and telephone numbers:

International	<a href="http://www.aten.com">http://www.aten.com</a>
North America	<a href="http://www.aten-usa.com">http://www.aten-usa.com</a>

# Chapter 1

## Introduction

### Overview

---

The ATEN Control System, incorporating the ATEN Control Box, the ATEN Configurator software (VK6000), and the ATEN Control System App is a standard Ethernet-based management system that connects all hardware devices in a room or large facility to provide centralized control of devices directly and effortlessly via a mobile device. The ATEN Control Box works as the main controller that provides great connectivity to all sorts of hardware devices commonly seen in a room. After connecting the hardware, the ATEN Configurator (VK6000) provides simple setup of the devices with easy step by step configuration. The ATEN Control System App then connects you to the VK2100 / VK1100 Control Box from any iOS, Android or Windows mobile device / tablet computer which empowers you with mobility to control all the hardware devices, in different rooms, whenever and however you like.

The VK2100 / VK1100 Control Box easily deploys into an existing installation and integrates seamlessly with ATEN VanCryst pro-A/V products and nearly any other hardware devices found in a room, including A/V equipment, lighting, conference systems, air conditioning, motion sensors, power switches and many more. The VK2100 / VK1100 Control Box serves as the central platform where hardware devices are connected – to be monitored, managed, and controlled directly via a tailor-made GUI from any iOS, Android, or Windows mobile device.

The VK6000 Configurator software facilitates quick setup and control of the devices in a few easy steps via an intuitive GUI. The VK6000 walks you through configuring the hardware, designing the interface and uploading Profiles to the VK2100 / VK1100. To provide control of the hardware devices, Profiles, which contain Viewers, are imported via the ATEN Control System App from any iOS, Android or Windows mobile device. Through an Ethernet connection, the ATEN Control System App enables you to import and update Profiles from the VK2100 / VK1100 Control Box via a point-n-tap user interface. Each Viewer is a customized control interface that grants you quick

access to target and control hardware devices. Use of any profile is protected with password authentication to ensure secure access.

The ATEN Control System is perfectly applicable in meeting rooms, conference centers, boardrooms, classrooms or any room that requires central and mobile control of a variety of hardware devices through a streamlined management system with optimum efficiency and performance.



## **Benefits**

---

### **Intelligent Control**

The ATEN Control System makes the interactions between your hardware devices smarter. Pre-programmed actions and triggers can provide a fully automated series of advanced operations that allow your devices to respond to each other intelligently, making your whole solution run smarter and smoother.

### **Optimized Performance**

The ATEN Control System has optimized the communication protocols that not only maintain a near-zero response time but also feature data encryption for extra protection.

### **Simplified Setup**

No matter how large the room or how complicated the hardware, the ATEN Control System can be deployed in 3 easy steps: connect the hardware, configure the system and upload profiles via a smart mobile app. Through an intuitive GUI, the process for setting up the controls for every room is simple and customizable, via straightforward predefined commands and macros, that do not require you to have complicated programming skills.

### **Effortless Expandability**

With a range of expansion boxes available, the ATEN Control System installation can grow to accommodate additional Serial, Relay and IR devices. Furthermore, the ATEN Library has 10,000+ device drivers and grows as you add new devices to the existing database via the Database Generator, making it expandable and easily manageable, whatever the size or scope of the installation.

### **User Centered Convenience**

An advanced, single-software solution creates an intuitive interface for any mobile device, while specific needs are customizable by selecting from an extensive library of actions and design elements to customize the control panel.

In addition, the ATEN Control System provides various support services that include driver downloads, database generation and upgrade tools – to help system integrators build easy-to-control environments effortlessly.

### **On-the-Go Control**

Intuitive system control can start with one room and scale up to multiple rooms in the same area or across regions. Toggling between profiles on an iOS, Android or Windows mobile device facilitates control of different rooms with simple point-n-tap operations. In addition, multiple mobile devices can be authorized with access to control the same room or multiple rooms, providing you with flexible, enhanced mobility, and tight security.

---

## Features

---

### **ATEN Control Box**

- ◆ Supports various connection interfaces:

Interface	VK2100 Control Box	VK1100 Compact Control Box
Serial Port	6	2
IR/Serial Port	4	2
Relay Channel	4	4
I/O Channel	4	-
Ethernet Port	1	1

- ◆ DC outputs for power supply connections
  - ◆ VK2100: equipped with 4 DC outputs
  - ◆ VK1100: equipped with 1 DC output
- ◆ 1 x USB port for easy profile upload
- ◆ IR Learning function for adding IR device drivers
- ◆ Supports native KNX IP for building management systems
- ◆ Telnet, TCP, UDP, ONVIF, PJLink, HTTP, and HTTPS compliant
- ◆ Supports project file backup
- ◆ Supports up to 8 ATEN Keypads
- ◆ Web GUI for easy system configuration
- ◆ 2 free licenses for mobile control\*
- ◆ Supports SSH communication for data monitoring
- ◆ Rack-mountable

---

**Note:** If you need more than two licenses for mobile control, contact your local sales representative.

---

## **ATEN Configurator (VK6000)**

- ◆ Simple profile setup with easy configuration steps via intuitive GUI
- ◆ Customizable GUI to be used on mobile devices and PC
- ◆ Supports ControlAssist that allows PC control (PC shutdown, media files, PowerPoint files)\*
- ◆ Built-in Database Generator for device driver setup and overall device management.
- ◆ Built-in ATEN Library comprising 10,000+ device drivers and complete ATEN VanCryst product drivers
- ◆ Event scheduling
- ◆ Two-way communication enables user-defined event monitoring to automatically trigger the next actions
- ◆ Test tool to verify commands in action before uploading the profile to the ATEN Control Box
- ◆ Simulator to simulate and review the customized GUI before uploading

---

**Note:** For details on the supported PC control actions, see *Supported PC Control Actions*, page 174.

---

## **ATEN Control System App**

- ◆ Allows administrators central control of multiple rooms via profiles on a mobile device or tablet computer
- ◆ Restrict user access to profiles via password authentication
- ◆ Synchronization of system controls amongst multiple mobile devices and tablet computers
- ◆ Any iOS, Android, or Windows mobile device can be used to control the system – no need to purchase costly

## **ATEN Keypads (8-button VK108US and 12-button VK112EU)**

- ◆ Fully customizable layout
  - ◆ VK108US: 14 layout combinations using 4 to 8 buttons
  - ◆ VK112EU: 125 layout combinations using 6 to 12 buttons
- ◆ System LED indicators for quick connection status check
- ◆ Dual-color LEDs for clear indication in dark environments
- ◆ Easy ID pairing with Control Box for Ethernet communication
- ◆ Scalability – a Control Box can connect up to 8 Keypads
- ◆ Versatile modes support flexible behavior settings for each button
- ◆ Intuitive Web GUI for easy configuration
- ◆ Redundant power supplies (DC power and PoE)
- ◆ Button engraving service

## **Requirements**

---

The following equipment is required for a installation:

### **Hardware Devices**

A device for each type of hardware connection that will be wired to the VK2100 / VK1100, which can include:

- ◆ Bi-directional RS-232/422/485 serial devices
- ◆ One-way IR or serial transmitter hardware devices
- ◆ Relay hardware devices
- ◆ Digital input hardware devices (VK2100)
- ◆ Digital output hardware devices (VK2100)
- ◆ Ethernet-controlled PLink, Telnet, ONVIF, TCP, UDP, HTTP, or HTTPS devices
- ◆ KNX IP interfaces for connecting KNX-compliant devices

### **Cables**

- ◆ Cat 5e/6 Ethernet cable used to connect the VK1100 and VK2100 to the local area network
- ◆ For serial devices with DB9 connectors use standard straight through cables.

### **Computer & Software**

- ◆ PC installed with the ATEN Configurator software (VK6000)
- ◆ Mobile Device installed with the ATEN Control System App

### **Minimum PC Requirements (VK6000)**

Supported operating systems for the ATEN Configurator software (VK6000) are shown in the table, below:

OS	Versions
Windows	Win 7, 8, 8.1, 10, or later

---

## Accessories

---

Optionally purchase ATEN accessories to enhance the functionality of your Control System. For more information, visit the ATEN website. Contact your ATEN dealer to purchase these accessories.

Model	Description
2XRT-0004G	Full Range IR Emitter (1.8 m)
2X-031G	Single Rack Mount Kit for VK1100
VK108US	8-button Keypad (US, 1 Gang)
VK112EU	12-button Keypad (EU, 2 Gang)
VK224	4-Port Serial Expansion Box
VK236	6-Port IR/Serial Expansion Box
VK248	8-Channel Relay Expansion Box
SA0141	DB9-F to RJ45-F Adapter
SA0145	RJ45-F to DB9-M Adapter

This Page Intentionally Left Blank



# Chapter 2

## Hardware Setup



1. Important safety information regarding the placement of this device is provided on *Safety Instructions*, page 193. Please review it before proceeding.
2. Make sure that the power to all devices connected to the installation are turned off. You must unplug the power cords of any computers that have the Keyboard Power On function.

### ATEN Control Box

---

#### Panel Components

##### VK2100 Front View

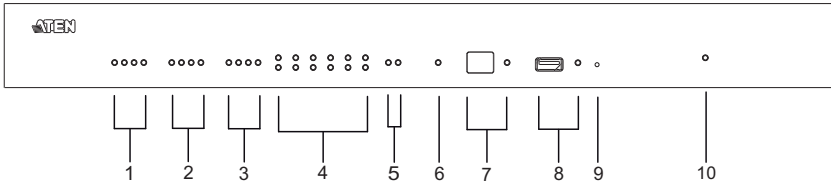

No.	Component	Description
1	Relay LED	The LED lights green to indicate an active device connection (closed loop).
2	IR/Serial LED	The LED lights green to indicate an active device connection and IR/Serial signals are being transmitted.
3	I/O LED	The LED lights green to indicate an active device connection and I/O signals are being transmitted.
4	Serial LED	The LED (1~6) lights green to indicate serial signals are being transmitted.

No.	Component	Description
5	Ethernet LED	<p>The LEDs provide information about the network connection:</p> <ul style="list-style-type: none"> <li>◆ <b>Link:</b> The LED blinks green to indicate Ethernet signals are being transmitted.</li> <li>◆ <b>ACT:</b> The LED lights green to indicate 100Mbps transmissions.</li> </ul>
6	DC Overload LED	<p>The LED lights orange to indicate DC output exceeds maximum output.</p> <p><b>Note:</b> When the LED lights orange, please unplug any of the connected devices to keep its total output under 24W.</p>
7	IR Receiver / LED	<p>This IR receiver passes the functions of a remote control to the VK2100 in learning mode. The distance between the IR remote and the receiver window should be kept under 10cm with a direct line of sight.</p> <ul style="list-style-type: none"> <li>◆ The LED blinks green to indicate the unit is ready to receive signals from an IR remote control.</li> </ul>
8	USB Port / LED	<p>This is where a USB device plugs in to upload Viewer files to the VK2100.</p> <ul style="list-style-type: none"> <li>◆ The LED blinks green to indicate Viewer files are being uploaded, and lights green to indicate a successful upload of Viewer files.</li> <li>◆ The LED lights orange to indicate Viewer files failed to upload.</li> </ul>
9	Reset	<p>This semi-recessed pushbutton can be pressed to reset the VK2100's network settings.</p>
10	Power LED	<p>Lights green when the unit is turned on.</p>

## VK2100 Rear View

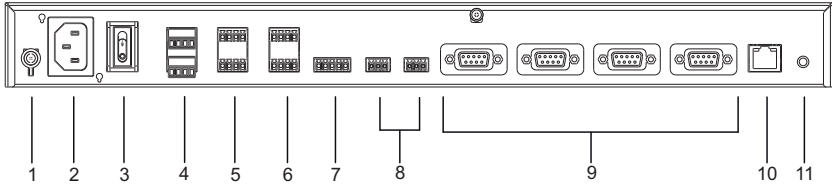

No.	Component	Description
1	Grounding Terminal	The grounding wire attaches here.
2	Power Socket	This is a standard 3-pin AC power socket. The power cord from an AC source plugs in here.
3	Power Switch	This is a standard rocker switch that powers the unit on and off.
4	DC Output Ports	Four outputs provide a total power output of 24W /2A max.
5	Relay Channels	Four channels; normally open, isolated relays with a contact rating of 24VDC, 2A max.
6	IR / Serial Ports	Four IR ports that can also be configured as RS-232 TX ports. pin1: Signal / pin2: Ground.
7	I/O Channels	Four channels that can be configured as digital input or digital output ports. <ul style="list-style-type: none"> <li>◆ Digital Input: 0-24VDC programmable input range or contact closure with +12VDC pull-up</li> <li>◆ Digital Output: 250mA sink from 12VDC</li> </ul> Pin1~4: Signal / Pin5: Ground
8	RS-232 Ports	Two RS-232 ports with TX/RX functions supported.
9	RS-232/422/485 Ports	Four ports with supported RS-232/422/485 conversion by pin assignment and RTS/CTS flow control. The RS232, RS422, or RS485 connection is defined by pin. For pin assignments, see page 32.
10	Ethernet Port	This RJ-45 port is used for the network connection. If no IP address is assigned within 30 seconds, the default IP settings will be used: IP: 192.168.0.60 / mask: 255.255.255.0
11	Controller ID Switch	This 16-segment switch is used for controller ID selection.

## VK1100 Front View

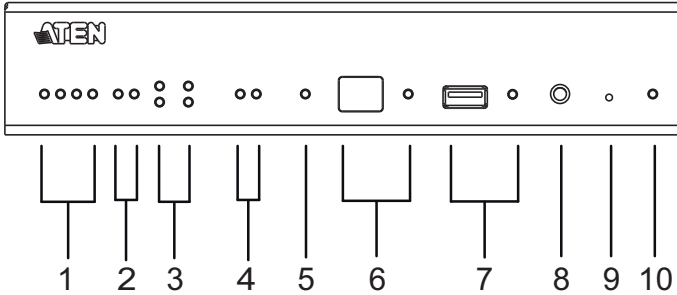

No.	Component	Description
1	Relay LED	The LED lights green to indicate an active device connection (closed loop).
2	IR/Serial LED	The LED lights green to indicate an active device connection and IR/Serial signals are being transmitted.
3	Serial LED	The LED (1~2) lights green to indicate serial signals are being transmitted.
4	Ethernet Link / ACT LED	The LEDs provide information about the network connection: <ul style="list-style-type: none"> <li>◆ <b>Link:</b> The LED blinks green to indicate Ethernet signals are being transmitted.</li> <li>◆ <b>ACT:</b> The LED lights green to indicate 100Mbps transmissions.</li> </ul>
5	DC Output Overload LED	The LED lights orange to indicate DC output exceeds maximum output. <p><b>Note:</b> When the LED lights orange, please unplug any of the connected devices to keep its total output under 12W.</p>
6	IR Receiver / LED	This IR receiver passes the functions of a remote control to the VK1100 in learning mode. The distance between the IR remote and the receiver window should be kept under 10cm with a direct line of sight. <ul style="list-style-type: none"> <li>◆ The LED blinks green to indicate the unit is ready to receive signals from an IR remote control.</li> </ul>

No.	Component	Description
7	USB Port / LED	This is where a USB device plugs in to upload Viewer files to the VK1100. <ul style="list-style-type: none"> <li>◆ The LED blinks green to indicate Viewer files are being uploaded, and lights green to indicate a successful upload of Viewer files.</li> <li>◆ The LED lights orange to indicate Viewer files failed to upload.</li> </ul>
8	Controller ID Switch	This 16-segment switch is used for controller ID selection.
9	Reset	This semi-recessed pushbutton can be pressed to reset the VK1100's network settings.
10	Power LED	Lights green when the unit is turned on.

### VK1100 Rear View

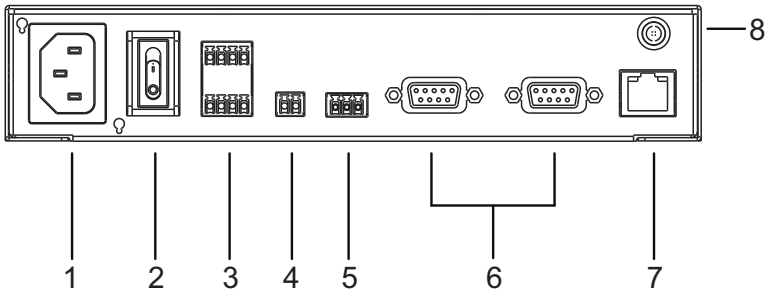

No.	Component	Description
1	Power Socket	This is a standard 3-pin AC power socket. The power cord from an AC source plugs in here.
2	Power Switch	This is a standard rocker switch that powers the unit on and off.
3	Relay Channels	Four channels; normally open, isolated relays with a contact rating of 24VDC, 2A max.
4	DC Output Ports	One output provides a total power output of 12W max.
5	IR / Serial Ports	Two IR ports that can also be configured as RS-232 TX ports. pin1: Signal / pin2: Ground.

No.	Component	Description
6	RS-232/422/485 Ports	Two ports with supported RS-232/422/485 conversion by pin assignment and RTS/CTS flow control. The RS232, RS422, or RS485 connection is defined by pin. For pin assignments, see page 32.
7	Ethernet Port	This RJ-45 port is used for the network connection. If no IP address is assigned within 30 seconds, the default IP settings will be used: IP: 192.168.0.60 / mask: 255.255.255.0
8	Grounding Terminal	The grounding wire attaches here.

## **Rack Mounting the ATEN Control Box**

### **VK2100**

The VK2100 can be mounted in a 19" (1U) system rack. To install the device in a rack, do the following:

1. Use the M3 x 8 Phillips head hex screws supplied with the Rack Mount Kit to screw the rack mounting brackets onto the front of the unit.

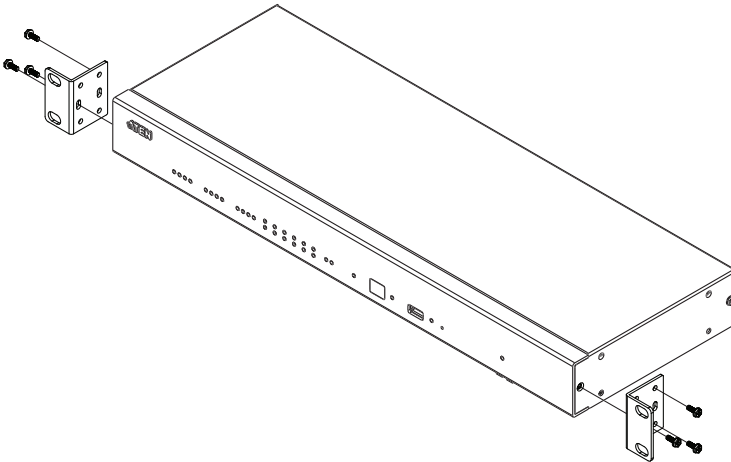

2. Position the unit in the front of the rack and align the holes in the mounting brackets with the holes in the rack.

3. Screw the mounting brackets to the rack.

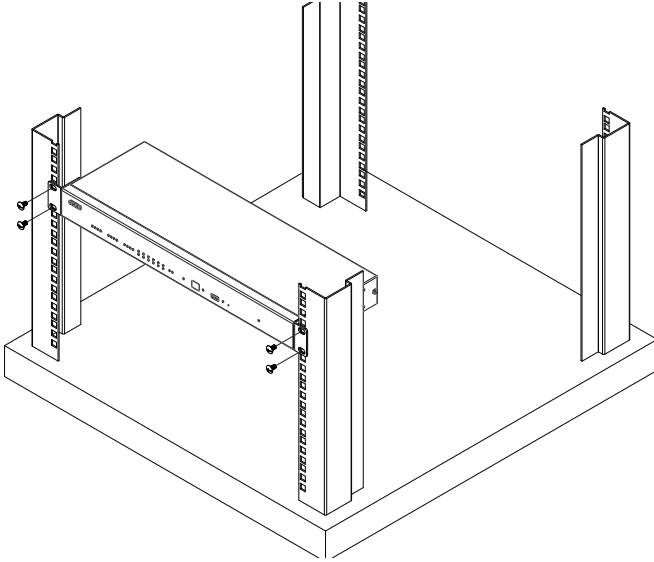

## VK1100

Optionally purchase an ATEN Rack Mount Kit to install VK1100 in a 19" (1U) system rack. To install the device in a rack, do the following:

1. Remove the side and bottom screws from the front of the VK1000.

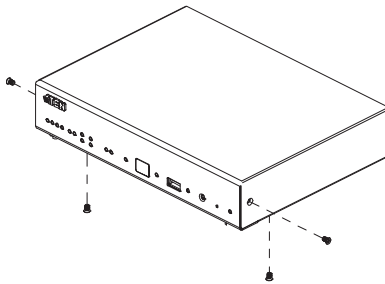

2. Use the two bottom screws removed in step 1 to secure the bottom of the brackets, and two M3X6 hexagon screws (from the rack mount kit) to secure the side of the bracket to the VK1100.

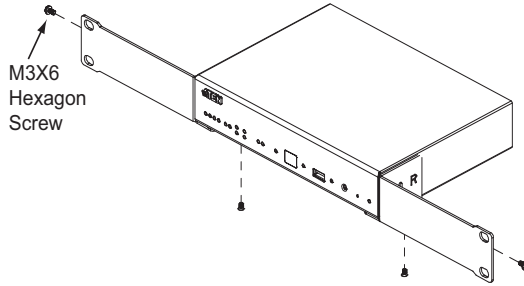

3. Screw the mounting brackets to the rack.

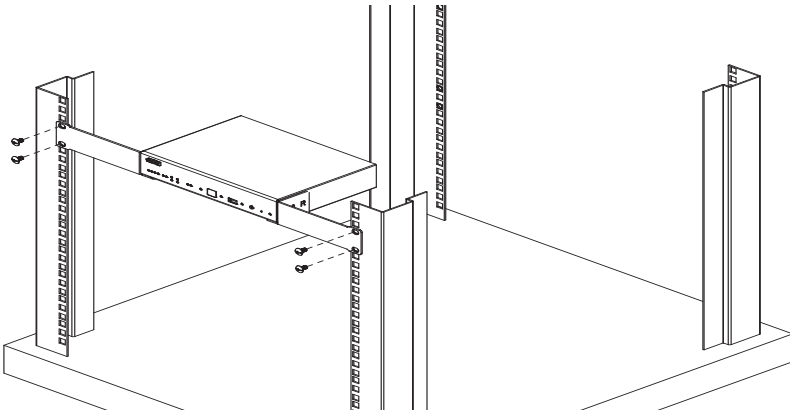



---

## Control Box Connections

Installation of the Control Box is a matter of connecting the appropriate wires. Refer to the installation diagrams on the pages that follow to setup each device and use the instructions below as a guide (each step provides a corresponding page with diagram for the VK2100 and VK1100), and do the following:

Connect the hardware devices to the Control Box using these instructions:

1. Use a grounding wire to ground the unit by connecting one end of the wire to the grounding terminal, and the other end of the wire to a suitable grounded object.

---

**Note:** Do not omit this step. Proper grounding helps to prevent damage to the unit from surges or static electricity.

---

2. Use a Cat 5e/6 cable to connect the Control Box's Ethernet port to the network.
3. Set the Controller ID to the appropriate setting for this unit.
4. Use the DC Output terminals to wire 12VDC power connections using the instructions on page 24.
5. Use the Relay terminals to wire relay device connections using the instructions on page 26.
6. Use the IR/Serial (TX) terminals to wire IR or serial device connections using the instructions on page 27.
7. Use the Digital I/O terminals to wire digital Input/Output device connections using the instructions on page 29.
8. Use the RS-232 terminals to wire RS-232 serial device connections using the instructions on page 31.
9. Use the DB-9 ports to wire RS-232/422/485 serial device connections using the instructions on page 32.
10. Connect IP-based devices to the same network as the Control Box. Refer to *Ethernet*, page 33 for details.

---

**Note:**

- ◆ For KNX-compliant devices, connect the devices to a KNX IP interface, and then connect the KNX IP interface to the network where the Control Box is installed.
  - ◆ To check if the KNX functions are supported by the Control Box, see *Datapoint Types*, page 197.
- 

11. Plug the power cord supplied with the package into the Control Box's 3-prong AC socket and then into an AC power source.

## VK2100 Installation Diagram

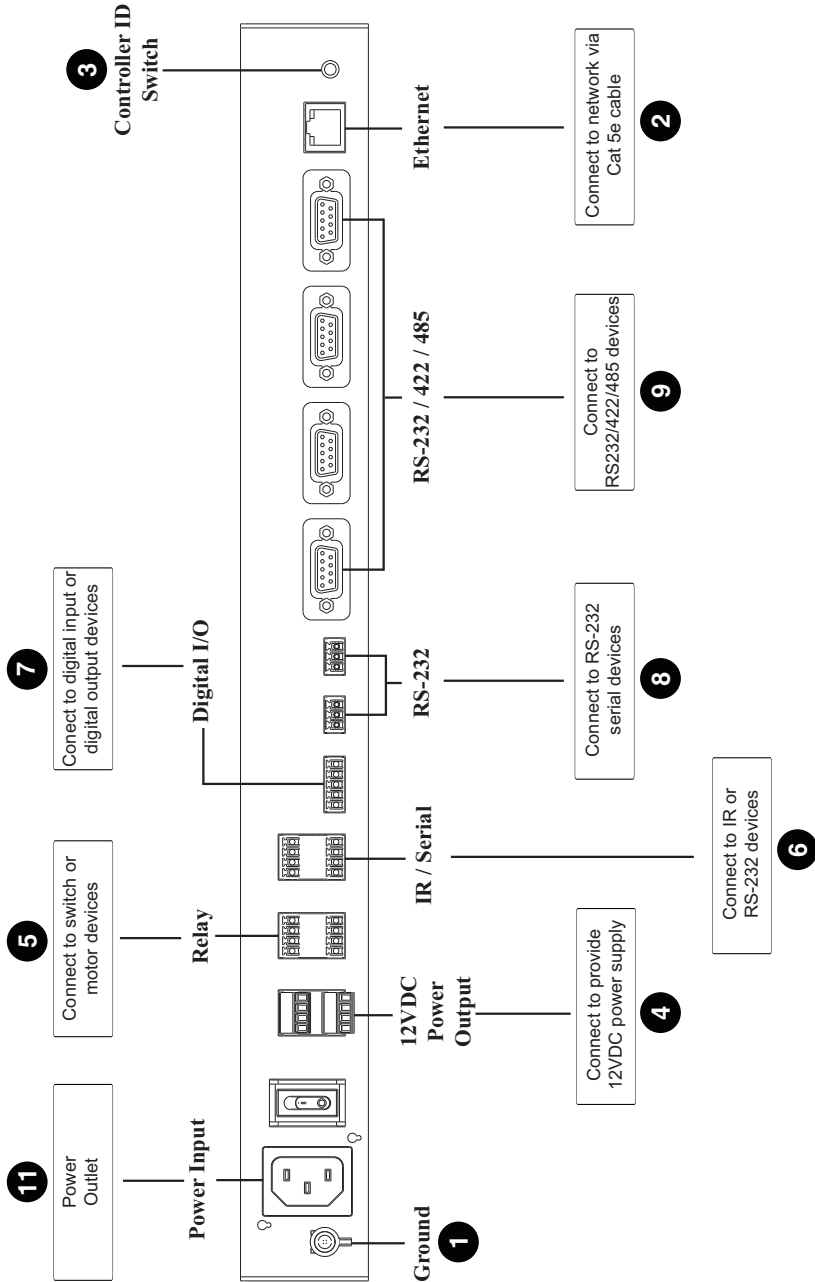

## VK1100 Installation Diagram

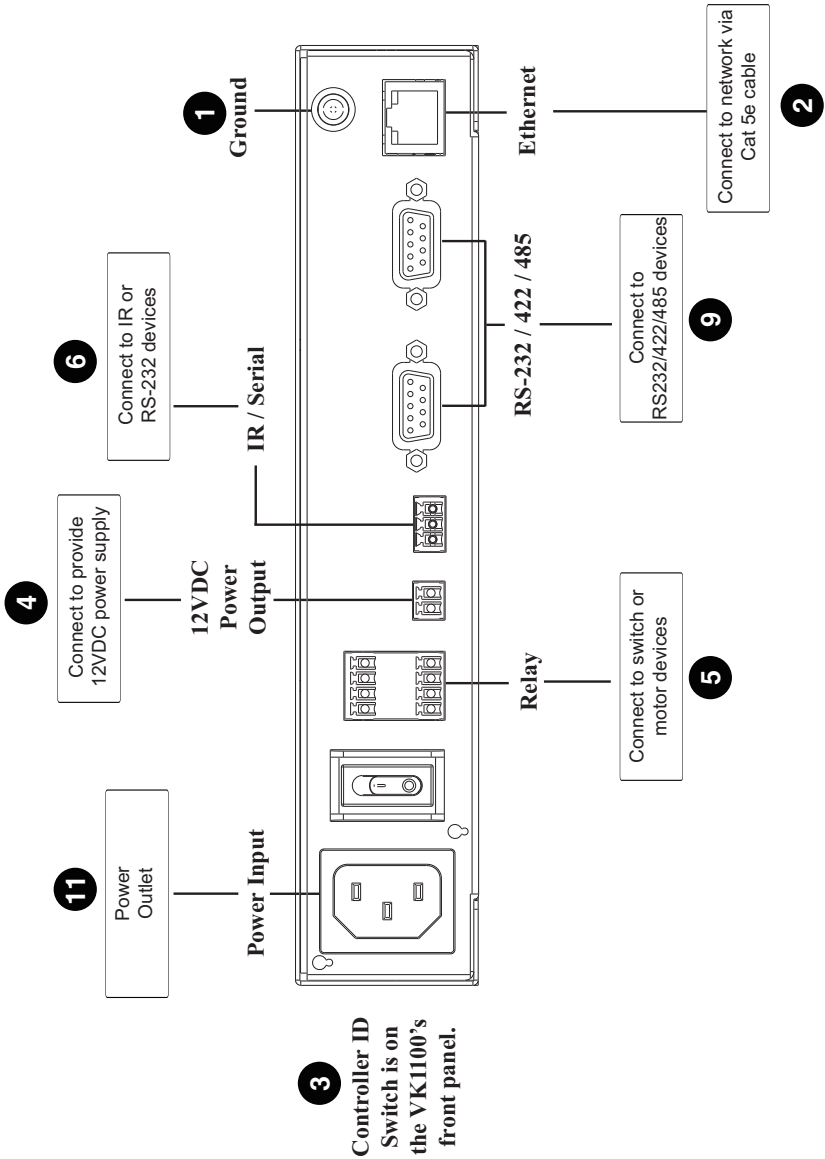

## 12VDC Power Output

One or four (VK1100 / VK2100) ports provide 12VDC of power with a total of 12 or 24 watts. The output can power one or four (VK1100 / VK2100) independent hardware devices, one or four (VK1100 / VK2100) loops for connected relay devices, or one or four (VK1100 / VK2100) digital output devices. If the combined current of the ports exceeds 1A (VK1100) or 2A (VK2100), the DC Power Overload LED lights orange, an alarm beeps three times and the ports are turned off. To return power to the ports, power off the Control Box, unplug all hardware connected to the 12VDC Power Output ports, power on the Control Box, and then plug in the hardware devices, one at a time, ensuring the current does not exceed 1A or 2A.

The diagrams on the next three pages show ports on the VK2100. The VK1100 is the same except that it has fewer 12VDC terminal blocks and no I/O ports.

### Independent Power Supply

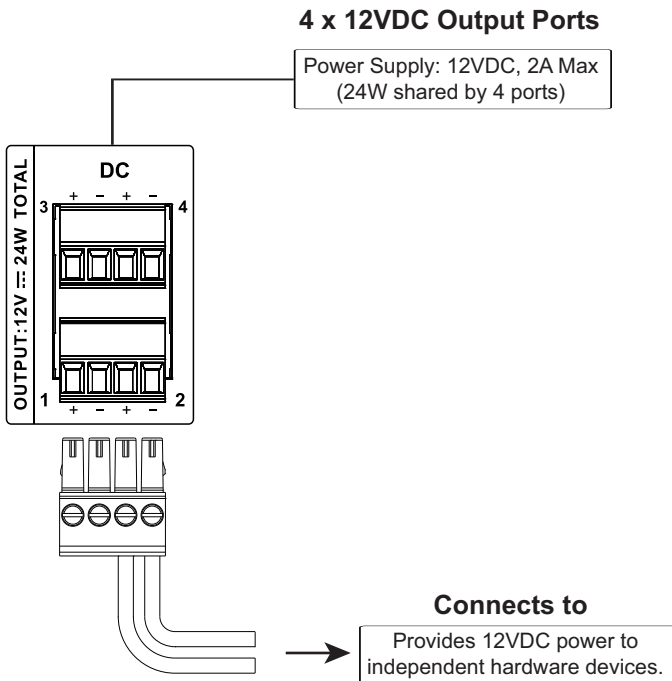

## Relay Power Supply

### 4 x 12VDC Output Ports

Power Supply: 12VDC, 2A Max  
(24W shared by 4 ports)

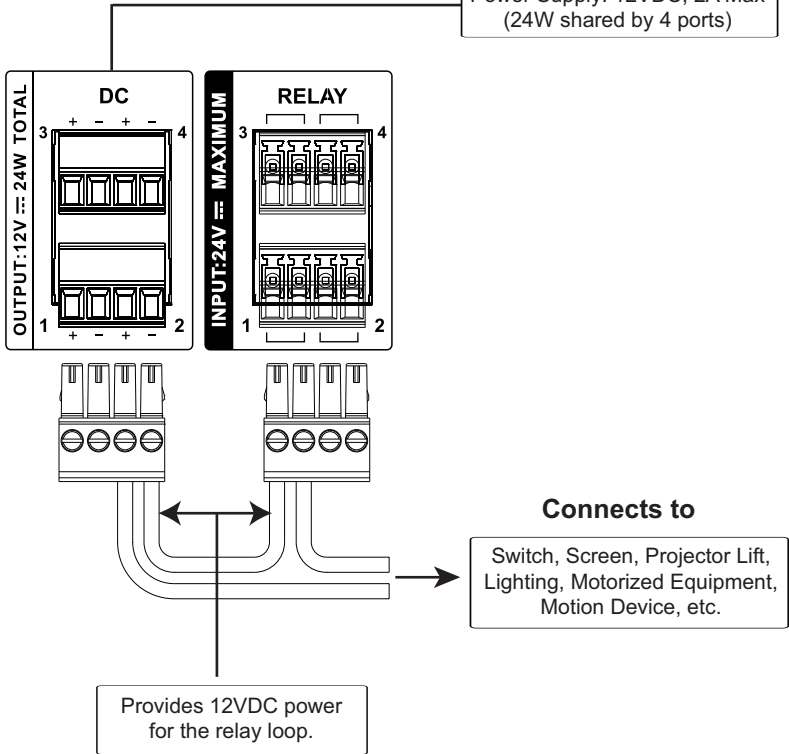

## Digital Output Power Supply (VK2100 only)

### 4 x 12VDC Output Ports

Power Supply: 12VDC, 2A Max  
(24W shared by 4 ports)

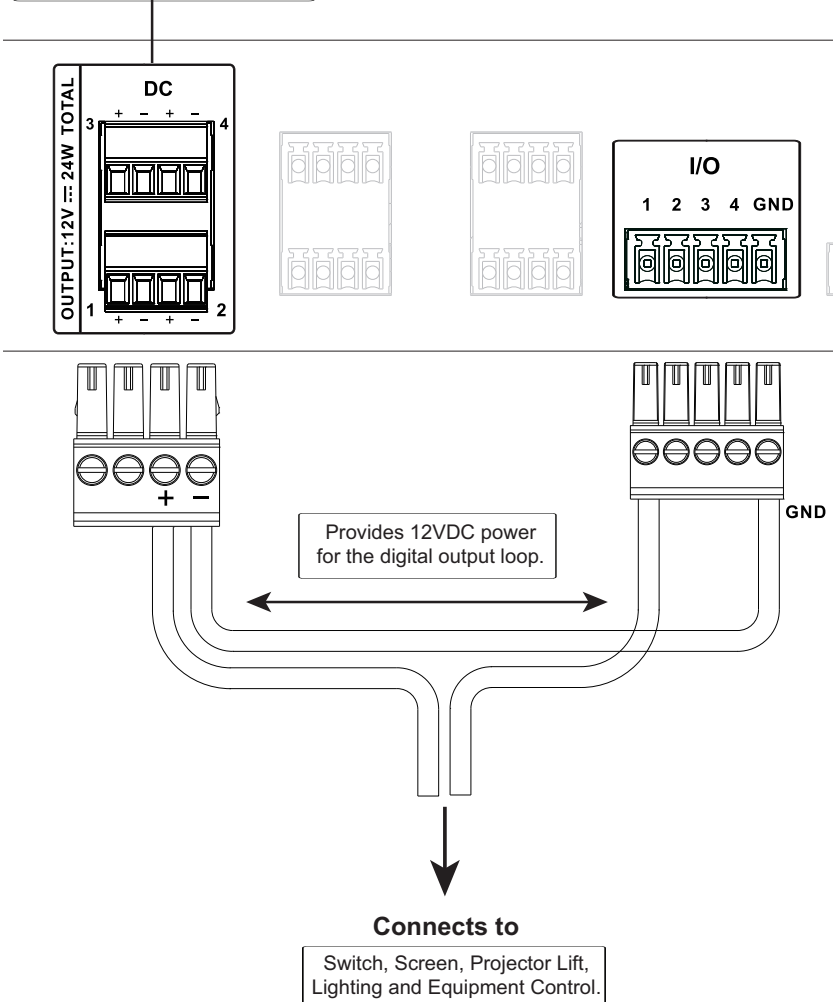

## Digital Output Dual Power Supply (VK2100 only)

### 4 x 12VDC Output Ports

Power Supply: 12VDC, 2A Max  
(24W shared by 4 ports)

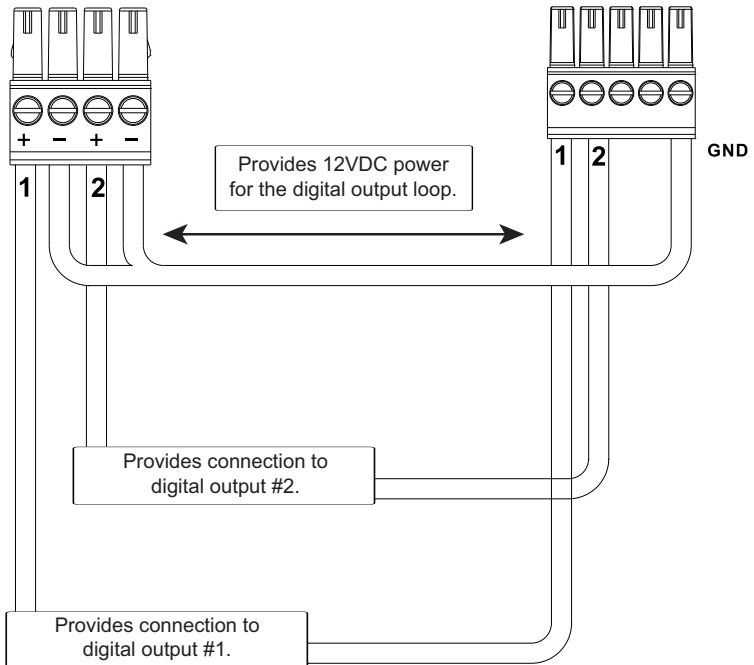
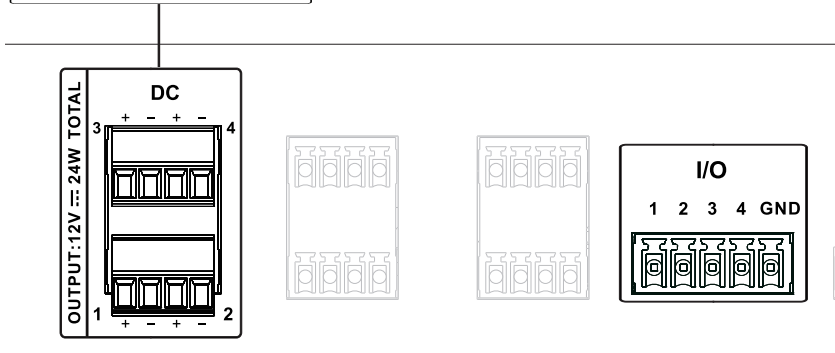

## Relay

These four Relay channels provide connections to control hardware devices such as electric screens, projector lifts and other motorized equipment. Each relay is normally open by default.

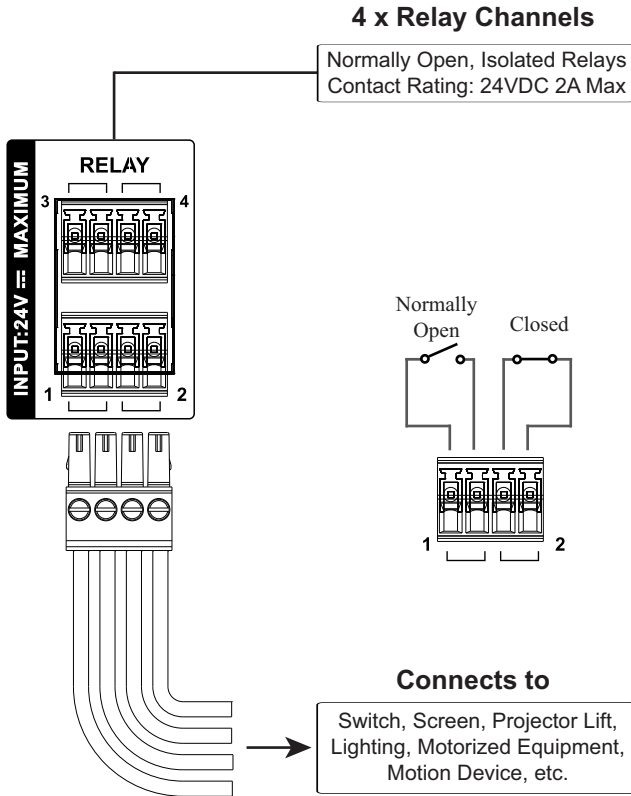



## IR / Serial

These two or four (VK1100 / VK2100) ports can be configured to connect IR and RS-232 devices. By default the ports are set to transmit IR signals. Use the ATEN Configurator software to configure the ports for RS-232 signals. The diagram below shows ports on the VK2100. The VK1100 is the same except that it has fewer terminals blocks and the Uni-directional setting is (0 to 5 V).

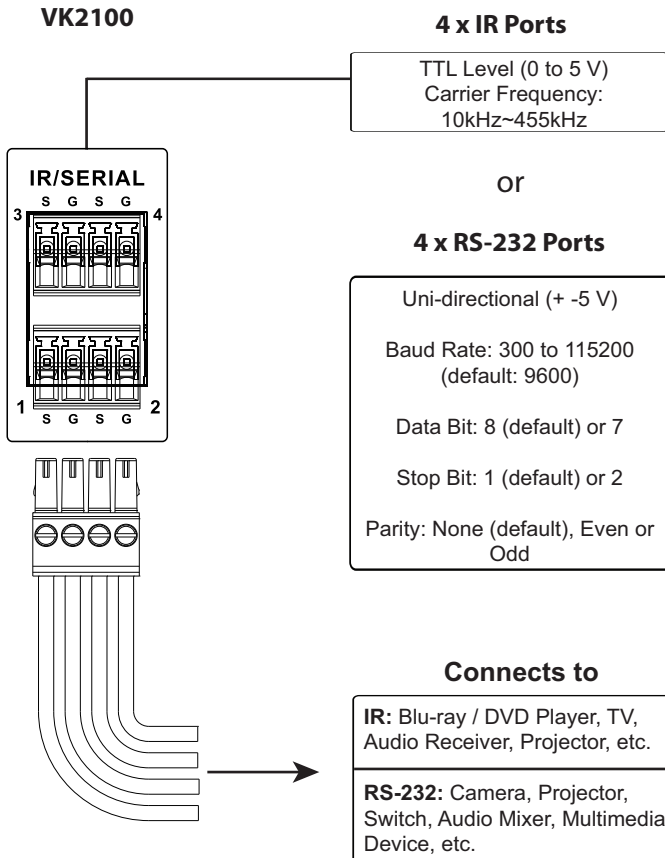

**IR Connection:** Connect a transmitter cable to the IR and Ground ports on the Control Box and install the IR transmitter on or near the device's IR receiving port, as shown on page 28.

**Serial Connection:** Connect the device's receiver (RX) and ground ports to the Serial (TX) and Ground ports on the Control Box. Next configure the same serial port setting on the Control Box and serial device so that they can communicate.

## One IR Transmitter

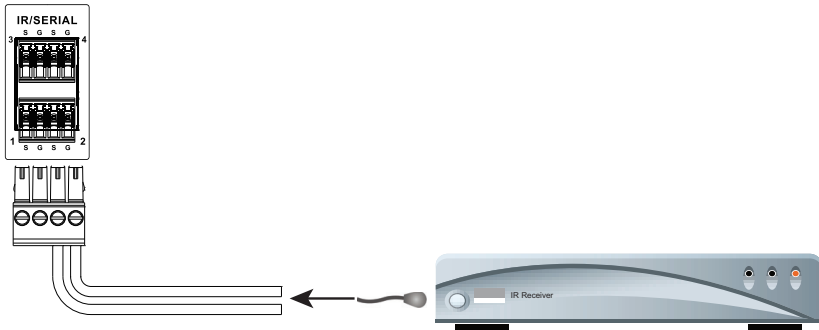

## Two IR Transmitters

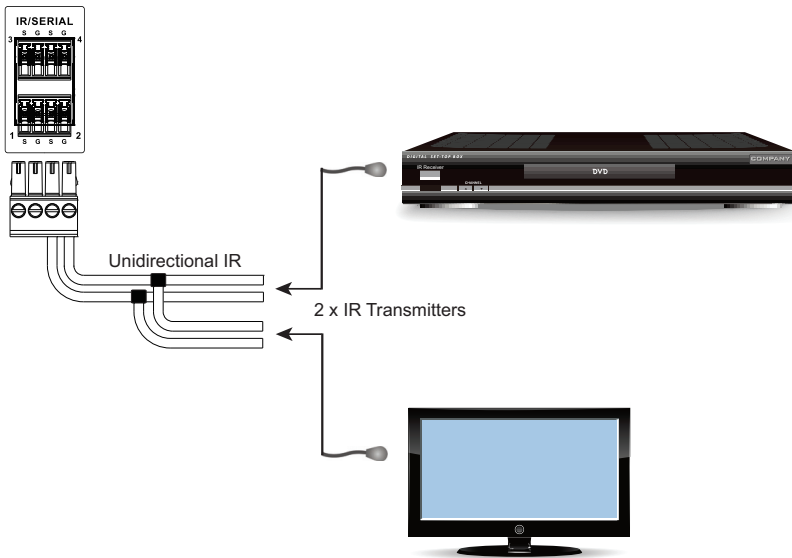

## Digital I/O

The four channels on the VK2100 can be used to connect Digital Input or Digital Output hardware devices such as switches, sensors, LEDs and relays. Each channel can be configured as either an Input (VDC), Input (Dry Contact) or Output channel.

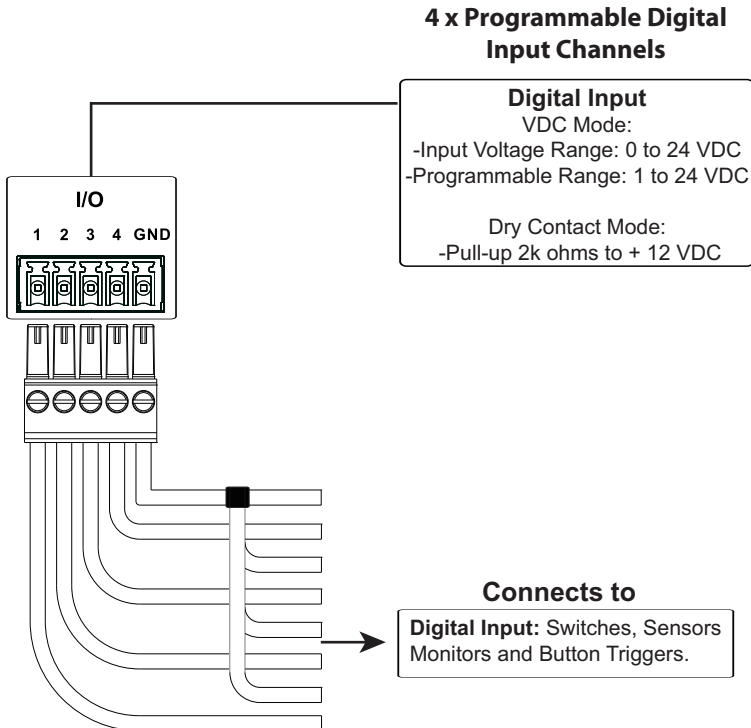

### Digital Input (Dry Contact):

Digital inputs are hardware devices (switches, sensors, monitors) with two circuit signals – open and closed. These two signals provide indicators from sensors or switches of an event. An event can be the on/off power, dry contact, sensor or switch status from a device. This information is used to trigger events and functions through the VK2100.

### Digital Input (VDC):

Digital input 12VDC hardware devices (temperature, current and monitor sensors) provide voltage signals between 1 and 24. A digital input port detects if a voltage is above/below a specific threshold (1 to 24). If the voltage coming from a hardware device is higher than the set value, the VK2100 will detect the digital input as high. If the voltage coming from a hardware device

is lower than the set value, the VK2100 will detect the digital input as low. This information is used to trigger events and functions through the VK2100.

**Digital Output:**

Digital output channels provide non-powered dry contact (open and closed) circuit control of hardware devices such as electric screens, projector lifts and other motorized equipment. Devices connected to the Digital Output port must be connected through a **Relay Module**, as shown below.

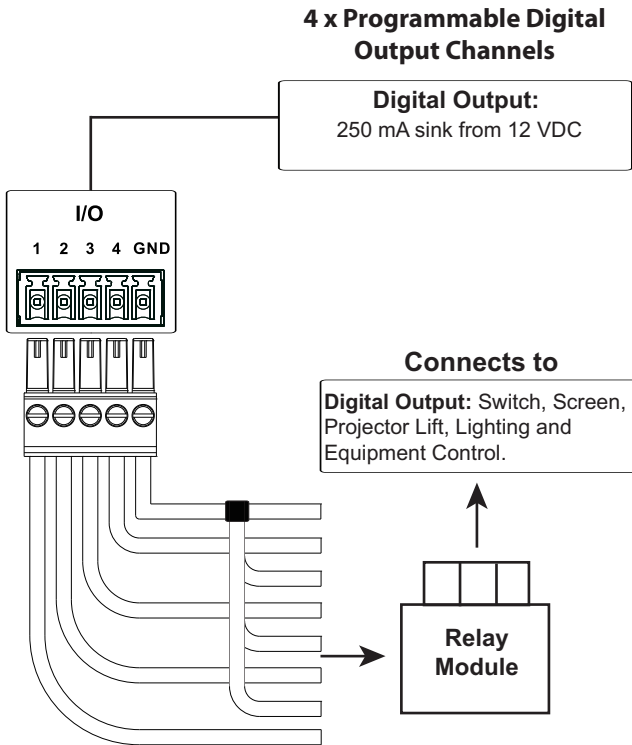

## RS-232

The two bi-directional RS-232 ports on the VK2100 provide serial control of hardware devices (projectors, matrix switches, etc.) and receive status messages from the connected devices. For bi-directional RS-232 control, the transmit, receive and ground pins must be wired on both the VK2100 and hardware device. Each hardware device requires different wiring. Please consult each hardware device's manual for details.

### 2 x Bi-directional RS-232 Ports

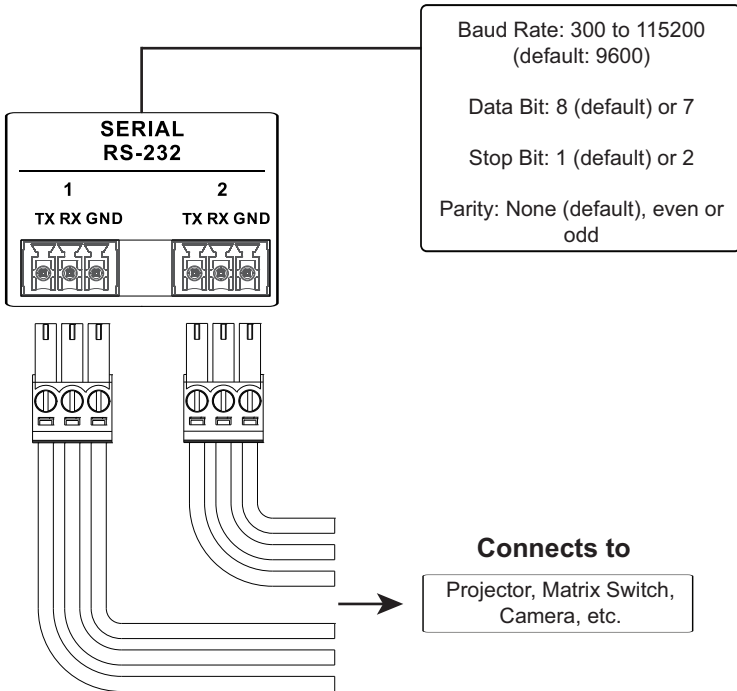

## RS-232 / 422 / 485

These two or four (VK1100 / VK2100) bi-directional ports provide serial control of hardware devices (projectors, switches, etc.) with programmable pin assignments and receive status messages from the connected devices. The diagram below shows ports on the VK2100. The VK1100 is the same except that it has fewer ports.

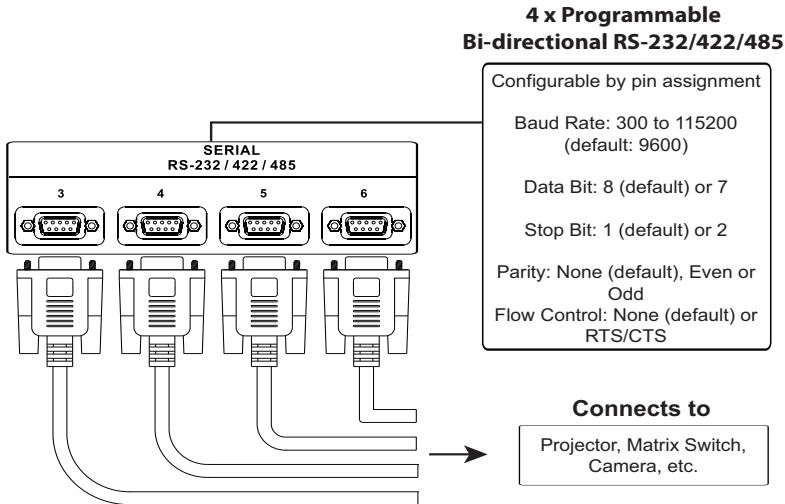

### Pin Assignments

RS-232	RS-422	RS-485
Pin2: RX	Pin1: RX-	Pin3: D+
Pin3: TX	Pin2: RX+	Pin4: D-
Pin5: GND	Pin3: TX+	
Pin7: RTS	Pin4: TX-	
Pin8: CTS	Pin5: GND	

## Ethernet

The RJ-45 port provides an Ethernet connection for GUI access (page 43) and the ability to add up to 25 LAN devices (page 70) per Control Box, as shown below.

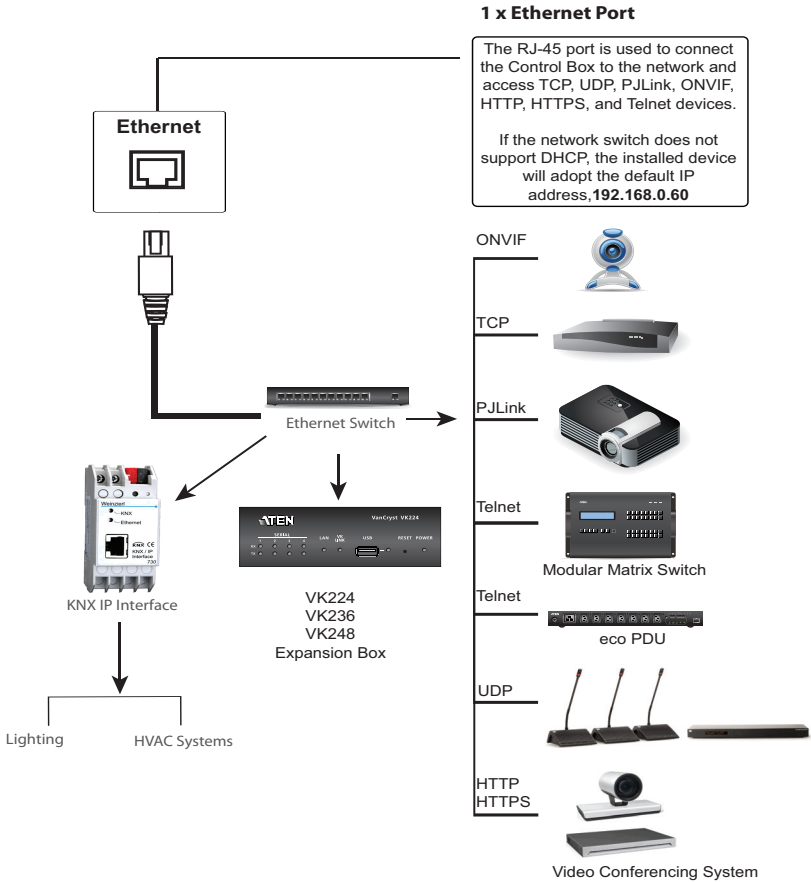

## ATEN Expansion Box

ATEN Expansion Boxes (sold separately) provide additional ports for a flexible expansion of the ATEN Control System. This allows you to add and control additional devices in an environment where more devices are required. With the advantage of an Ethernet-based connection, the expansion boxes are easily connected to the Control Box via a LAN connection from a variety of locations across a network. The diagram below provides an example of the VK224 4-Port Serial Expansion Box setup.

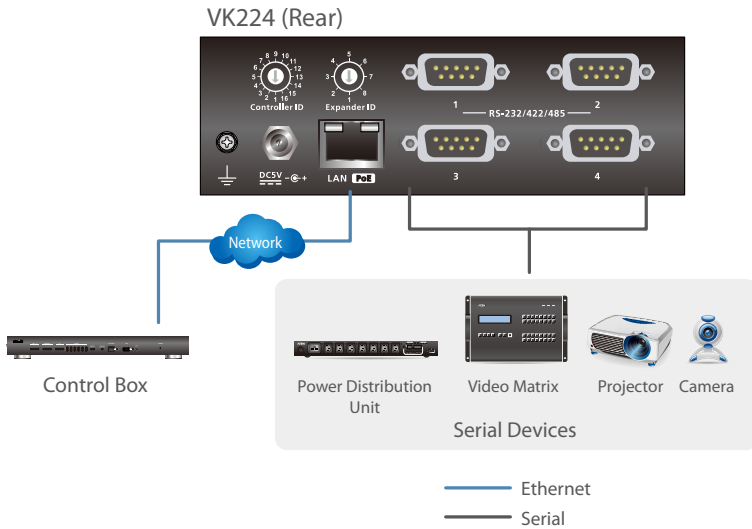

**Note:**

- To add and configure ATEN Expansion Boxes, see *The Device Configuration List*, page 70 and *Expander*, page 71.
- The available Expansion Box models include:

Model	Description
VK224	4-Port Serial Expansion
VK236	6-Port IR/Serial Expansion Box
VK248	8-Channel Relay Expansion Box



## ATEN Keypad

The ATEN Keypad mounts to a wall to provide control of hardware through a Control Box. The setup of the Keypad to the Control System can be illustrated as follows:

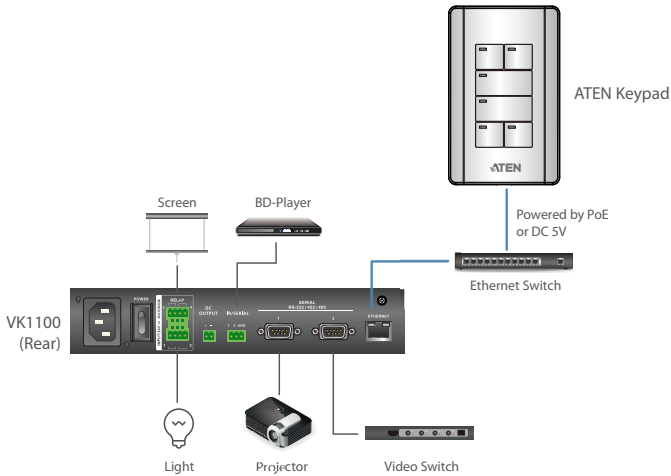

### Note:

- ◆ The following Keypad models are available:

Model	Description
VK108US	8-Button Keypad (US, 1 Gang)
VK112EU	12-Button Keypad (EU, 2 Gang)

- ◆ You can have your Keypad buttons customized with text engraving. To make the order, go the this link:

[https://www.aten.com/ext\\_data/global\\_en/VK\\_Keypad\\_Engraving\\_Service/aten\\_keypad.html](https://www.aten.com/ext_data/global_en/VK_Keypad_Engraving_Service/aten_keypad.html)

## **Installation**

To install the Keypad, follow the steps below:

1. Make sure you have created and uploaded a control interface (Viewer) for the Keypad and uploaded the Viewer to the Control Box. For details, see *Design*, page 82.
2. Prepare the installation site.
  - a) Choose a location where cables are free of interference.
  - b) Prepare a recession in the wall based on the following dimensions.

### **VK108US**

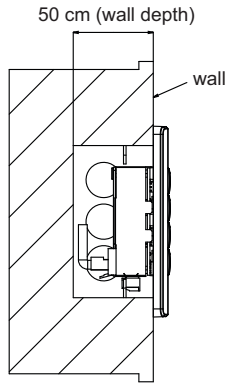

Installing with a wall box

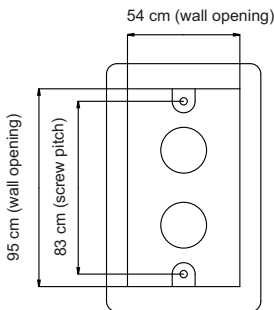

Installing without a wall box

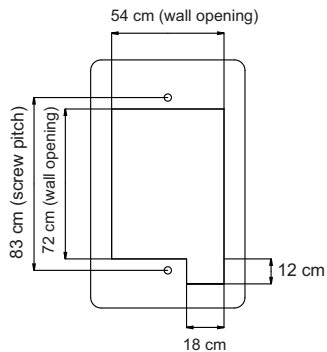

## VK112EU

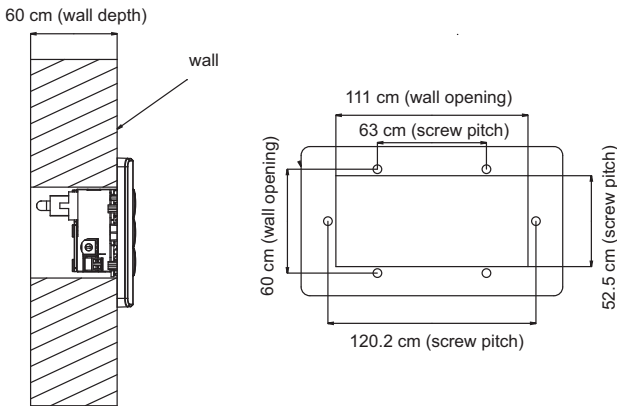

3. Adjust the keypad ID switch (blue) to assign an ID number for the Keypad.
4. Adjust the Control Box ID switch (black) to specify the ID number of the Control Box which the Keypad will work with. One ATEN Control Box can work with up to 8 Keypads.
5. Connect the Keypad to LAN using an Ethernet cable to provide network connectivity and power.

---

**Note:** PoE is only supported if a power sourcing equipment is installed.

---

6. If you do not have a power sourcing equipment to supply power through the Ethernet cable, follow the steps below to prepare the power adapter and then plug it to the Keypad.

---

**Note:** Optionally purchase an ATEN power adapter for this application.

---

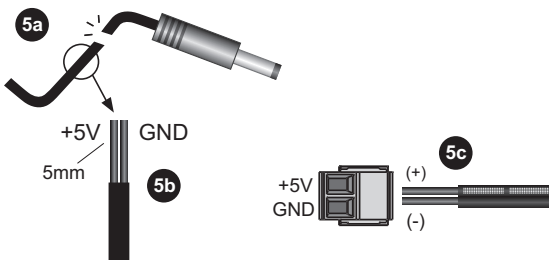

- a) Cut the connector end of the power adapter cable.
- b) Strip 0.5 cm off the insulation cover of the power adapter cable to expose the two wires, the +5V wire, and the grounding wire.
- c) Insert the exposed wires into the supplied 2-pin terminal block.

---

**Note:** To determine the wire polarity, use a voltmeter.

---

- 7. The LAN and Link LEDs light green to indicate that the Keypad successfully links to the assigned Control Box.

---

**Note:**

- ◆ Make sure that the Keypad is in the same subnet with its assigned Control Box.
  - ◆ The Keypad adopts the default IP address **192.168.0.60** if the network switch does not support DHCP. To configure the IP address, log in the web interface using the default IP address and the default password (**password**).
- 

- 8. Secure the Keypad to the wall.
- 9. Follow the layout created in the profile and assemble the button caps onto the Keypad.
  - a) Assemble button caps of the same row with each other.



- b) From the top row, attach each row of button caps to the Keypad by pressing on the hinges.

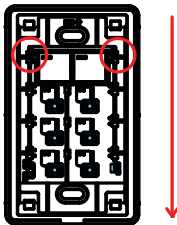

**Caution:** When removing button caps, place your fingers on the top of button caps and then press downwards, as illustrated below. Pressing upwards from the bottom may cause damages to the button caps.

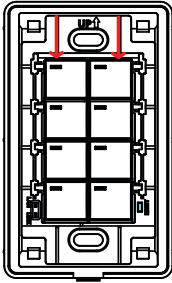

10. Attach the faceplate to the Keypad.

### VK108US

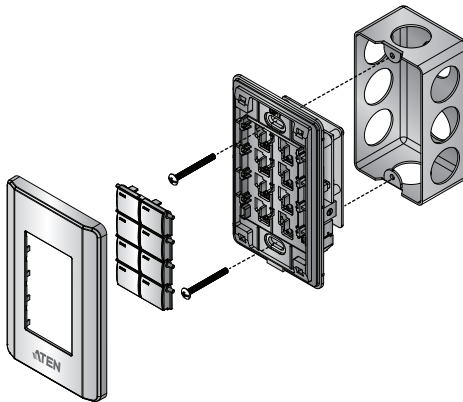

### VK112EU

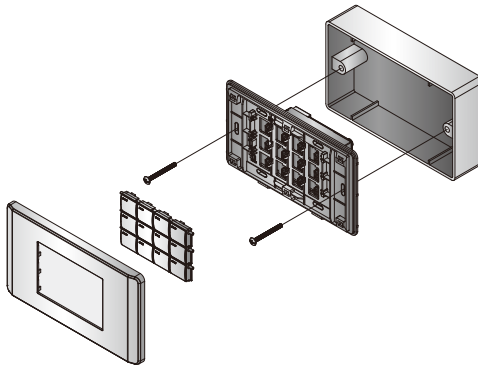

## Component

The VK108US and VK112EU Keypads share the same hardware layout. For demonstration purpose, VK112EU is used as an example below.

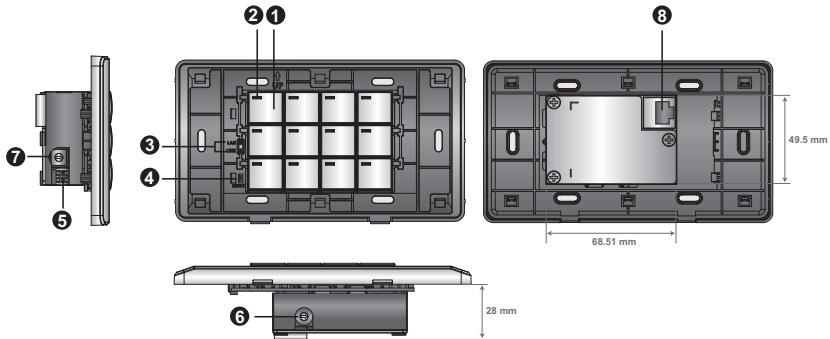

No.	Component	Description
1	Buttons	<p><b>VK108US</b></p> <p>The Keypad can be customized up to 14 different layouts using 4 to 8 buttons.</p> <p><b>VK112EU</b></p> <p>The Keypad can be customized up to 125 different layouts using 6 to 12 buttons.</p>
2	Button LEDs	<p>A button LED:</p> <ul style="list-style-type: none"> <li>◆ Lights orange to indicate the power is on.</li> <li>◆ Lights white to indicate the Keypad is in operation.</li> <li>◆ Blinks orange and white to indicate that firmware upgrade is in progress.</li> </ul>
3	System LED Indicators	<ul style="list-style-type: none"> <li>◆ LAN: lights green to indicate that the Keypad is connected to LAN.</li> <li>◆ Link: lights green to indicate that the Keypad is connected to the assigned Control Box.</li> </ul>
4	Reset Pushbutton	Press to reset the Keypad to its default network settings.
5	DC Power	Plug a power adapter into this DC power input.
6	Keypad ID Switch (blue)	Sets the ID of the keypad (1~8).
7	Control Box ID Switch (black)	Sets the ID of the Control Box (1 ~ 16).

No.	Component	Description
8	LAN Port	<ul style="list-style-type: none"> <li>Connects the Keypad to LAN</li> <li>Supplies power (PoE) if a power sourcing equipment is installed.</li> </ul>

## Layout Examples

### VK108US

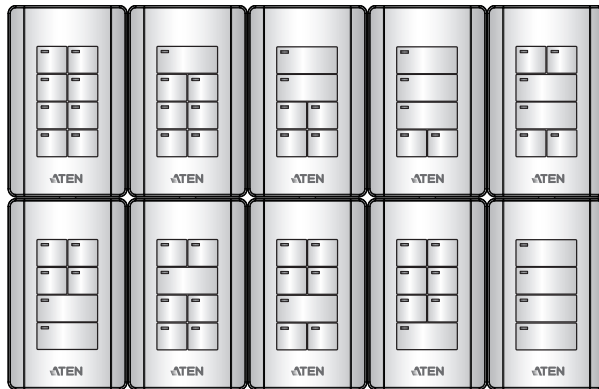

### VK112EU



This Page Intentionally Left Blank



# Chapter 3

## Browser Operation

### Overview

---

The Control Box can be configured over a standard TCP/IP connection via its built-in Graphical User Interface (GUI). Because it can be accessed from anywhere over a network or the Internet, operators can easily log in via a web browser. The web interface can be used to upload licenses, set the access key, enable monitors and update the firmware.

### Logging In

---

To access the GUI, type the IP address of the Control Box into the address bar of any browser. If a Security Alert dialog box appears, accept the certificate – it can be trusted. The Welcome screen appears:

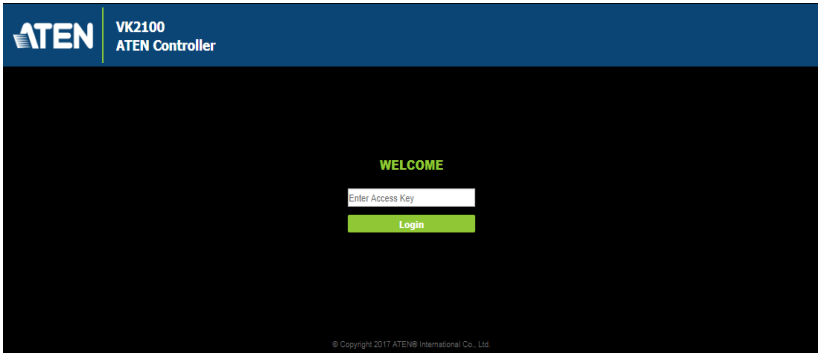

- ◆ The default IP address is **http://192.168.0.60**
- ◆ The default password is: **password**
- ◆ Enter the password, then click **Login**.
- ◆ Only one user can log in at a time.
- ◆ Supports Internet Explorer browsers IE9 and higher

## Dashboard

The *Dashboard* appears when you successfully log in to the Control Box. The Dashboard gives a quick view of each setting and provides a link to each page. Click **Manage** to configure the settings.

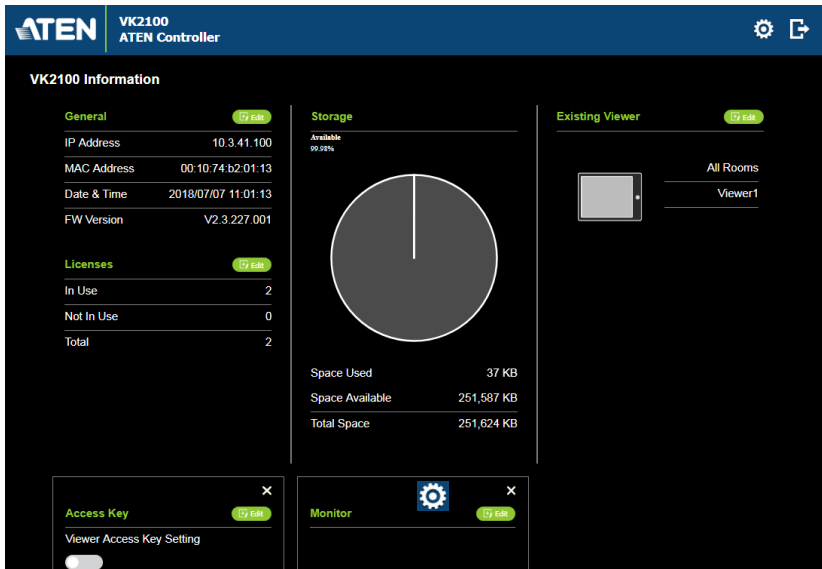

The top bar provides two options:

Click to enter the **Settings** page.



Click to **Logout** of the web session.

## Settings

The *Settings* page contains tabs to provide options to configure the Control Box. The page is divided into two parts, the **Interactive Display Panel** which is used to configure the options and the **Top Bar** which provides icons to exit the settings page and log out of the web session.

The Settings page opens on the **General** tab, as shown below:

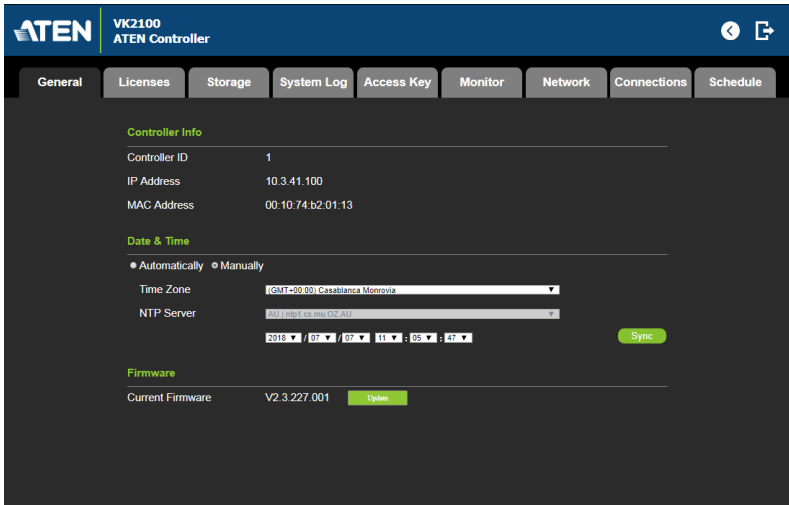

The *General* tab provides settings and information about the Control Box, as described in the table below.

Controller Info	<p>Provides network and identification information pertaining to the Control Box.</p> <ul style="list-style-type: none"> <li>◆ <b>Controller ID:</b> Displays the Control Box ID # set on the rear of the unit.</li> <li>◆ <b>IP Address:</b> Provides the IP address of the Control Box.</li> <li>◆ <b>MAC Address:</b> Provides the hardware MAC address of the Control Box.</li> </ul>
Date & Time	<p>Provides two options to set the date and time:</p> <ul style="list-style-type: none"> <li>◆ <b>Time Zone:</b> To establish the time zone for the Control Box, use the drop-down menu and choose the city that most closely corresponds to where it is located.</li> <li>◆ <b>Set Manually:</b> Use the drop-down menus to manually set the Date (Year/Month/Day) and Time (Hour:Minute:Second).</li> </ul>

Firmware	<p>Displays the Current Firmware version and option to upgrade.</p> <p>Click <b>Update Firmware</b> to open the <i>Firmware Upgrade</i> window. Click <b>Browse</b> to select the firmware upgrade file.</p> <p>When <b>Check FW Version</b> is selected, the system will check the current firmware version against the one being used to upgrade the Control Box. If the device version is higher than the upgrade version a dialog box informs you and gives you the option to continue or cancel.</p> <p>After the file has been selected, click <b>Update</b> to start the firmware upgrade.</p>
----------	---

## Licenses for Mobile Control

A license is a software permit that an ATEN Control Box grants to a mobile device when the mobile device connects to the ATEN Control Box for remote control. Each ATEN Control Box comes with two free licenses stored in the device itself, allowing two mobile devices to remotely access the ATEN Control Box at the same time. You can have up to 10 licenses to an ATEN Control Box. To purchase additional copies of license, contact your local sales representative.

You can use the Licenses tab to:

- ◆ Find out the total number of licenses, the number of licenses that are available, and those that are in use
- ◆ Upload licenses to the Control Box
- ◆ View license information

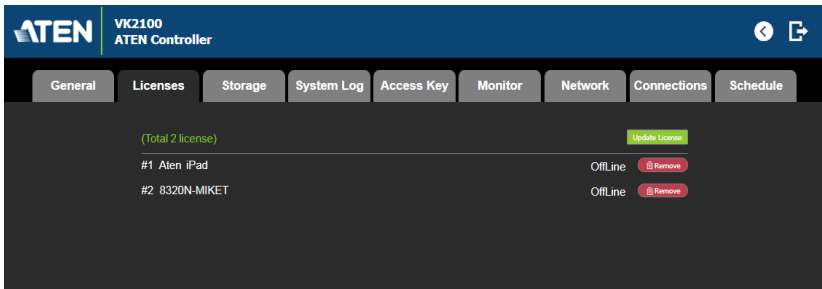

Licenses	<ul style="list-style-type: none"> <li>◆ <b>In Use:</b> displays the number of licenses being used by mobile devices.</li> <li>◆ <b>Not in Use:</b> displays the number of licenses available for use.</li> <li>◆ <b>Total</b> shows the number of licenses purchased for use on the Control Box.</li> </ul>
Update License	Clicking <b>Add</b> opens the <i>Add License</i> window to upload new licenses to the Control Box. Click <b>Browse</b> to locate the license file and Add to upload the license(s).
Remove	When a device is accessing the Control Box you can click the <b>Remove</b> button to disconnect the session.

## Storage

The *Storage* tab displays information about the space available for storing viewer profiles on the Control Box.

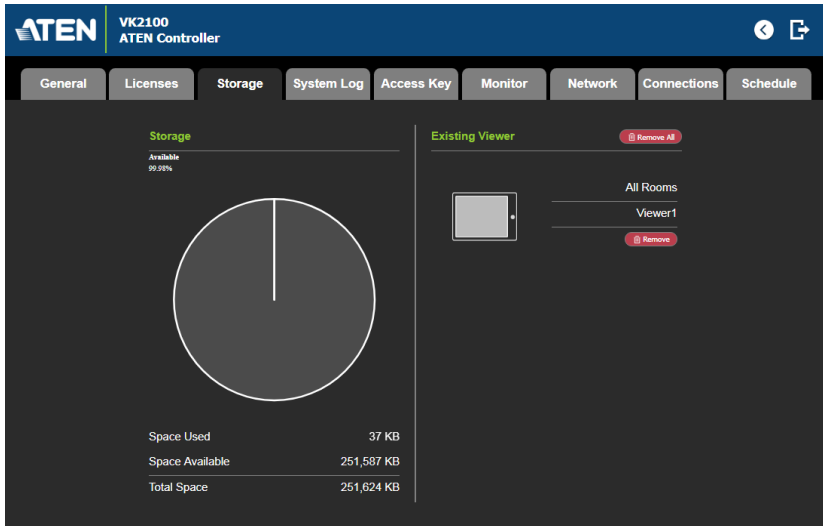

Storage	<p>This section shows a graph displaying the percentage of space available on the Control Box to upload viewer profiles, as well as:</p> <ul style="list-style-type: none"> <li>◆ <b>Space Used:</b> The amount of space currently being used to store viewer profiles uploaded to the Control Box.</li> <li>◆ <b>Space Available:</b> The amount of space currently available to store viewer profiles on the Control Box.</li> <li>◆ <b>Total Space:</b> The total amount of space available to store viewer profiles on the Control Box.</li> </ul>
Existing Viewer	<p>This section lists all the viewer profiles that are currently stored on the Control Box with their name and assigned room. Click <b>Remove</b> to delete a single viewer profile or <b>Remove All</b> to delete all viewer profiles from the Control Box.</p>

## Access Key

The *Access Key* tab allows you to manage the password that is used to upload/download viewer files to the Control Box and from a mobile device.

Show on dashboard	Check this box to show the Access Key settings on the Dashboard.
Current Access Key	Enter the password required to upload/download viewer profiles so that you can create a new access key.
New Access Key	Enter the current password in the <i>Current Access key</i> box and then use the <i>New Access Key</i> box to enter a new password, finally use the <i>Confirm Access Key</i> box to re-enter the new password.
Enable Viewer Access Key	Check this box to require a password when uploading/downloading viewer profiles to the Control Box and from a mobile device.
Save	Click to save changes to the access key settings.

## Monitor

The *Monitor* tab allows you to view and enable the monitors that have been configured for Flags and digital input devices in the VK6000 software. Check the **Show on dashboard** box to show the *Monitor* settings on the Dashboard. Click the slide bar next to the monitor you want to enable or use the drop-down menu to select **All On** or **All Off**.

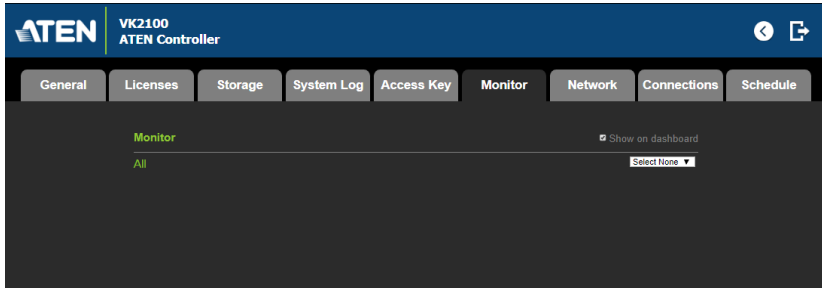

For more information about creating monitors, see *Library*, page 119.



## Network

The *Network* tab allows you to view and configure the Control Box's network settings. Select **Manually** to set a static *IP Address*, *Subnet Mask*, and *Default Gateway*, or **Use DHCP** to have the server assign an IP address to the Control Box.

**Note:** Make sure to set the Control Box's IP address and Default Gateway to the same subnet.

The screenshot shows the ATEN VK2100 ATEN Controller interface. The top navigation bar includes tabs for General, Licenses, Storage, System Log, Access Key, Monitor, Network (selected), Connections, and Schedule. The Network configuration page is displayed with the following settings:

- Get IP Address:**  Manually,  Use DHCP
- IP Address:** 10 . 3 . 41 . 100
- Subnet Mask:** 255 . 255 . 255 . 0
- Default Gateway:** 10 . 3 . 41 . 254
- Get DNS Server:**  Automatically,  Manually
- Preferred DNS Server:** 10 . 0 . 1 . 7
- Alternate DNS Server:** 10 . 0 . 1 . 6

Buttons for Save and Cancel are located at the bottom right of the configuration area.

## Connections

The *Connections* tab allows you to view the connection statuses and IP addresses of licensed devices, ATEN Keypads, and ATEN Expansion Boxes.

The screenshot shows the ATEN VK2100 ATEN Controller interface. The top navigation bar includes the ATEN logo, the device name 'VK2100 ATEN Controller', and navigation icons. Below the navigation bar is a menu of tabs: General, Licenses, Storage, System Log, Access Key, Monitor, Network, Connections, and Schedule. The 'Connections' tab is selected and active.

Under the 'Connections' tab, there are two sections:

- Licensed Devices and Keypads**: A table with columns for Name, ID, IP Address, and Status. It lists two devices: #1 (8320N-MIKET) and #2 (8060P-CHRISTINE), both with 'N/A' for ID and IP Address, and 'Offline' for Status.
- Expansion Box**: A table with columns for Name, ID, IP Address, and Status. This table is currently empty.

	Name	ID	IP Address	Status
#1	8320N-MIKET	N/A	N/A	Offline
#2	8060P-CHRISTINE	N/A	N/A	Offline

	Name	ID	IP Address	Status
--	------	----	------------	--------

## Schedule

The *Schedule* tab lists scheduled events predefined using the ATEN Configurator. You can use this tab to do the following:

- ◆ Enable or disable scheduled events.
- ◆ Enable or disable scheduled days

For details on setting up scheduled events, see *Scheduled Events*, page 136.

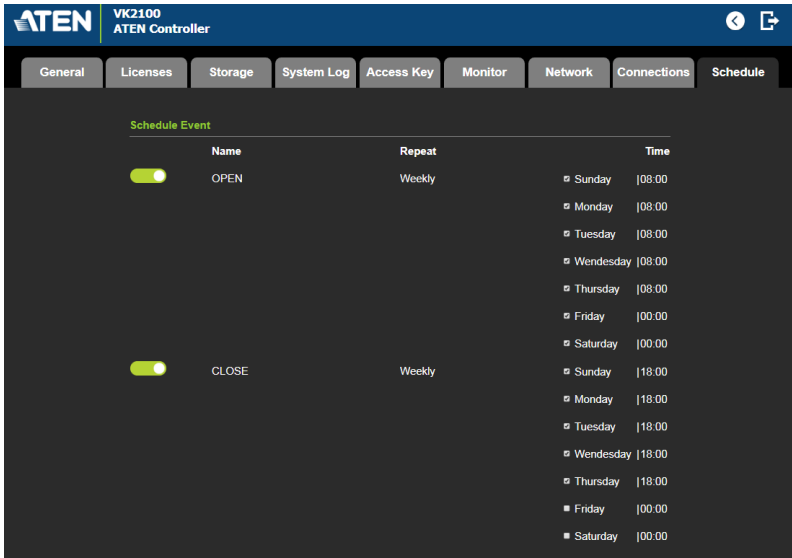

The screenshot shows the ATEN VK2100 ATEN Controller web interface. The top navigation bar includes the ATEN logo, the model name 'VK2100 ATEN Controller', and navigation icons. Below the navigation bar is a menu with tabs: General, Licenses, Storage, System Log, Access Key, Monitor, Network, Connections, and Schedule. The 'Schedule' tab is active, displaying a 'Schedule Event' section. This section contains two event entries, each with a toggle switch, a name, a repeat frequency, and a list of days and times.

Name	Repeat	Time
<input checked="" type="checkbox"/> OPEN	Weekly	<input type="checkbox"/> Sunday   08:00 <input type="checkbox"/> Monday   08:00 <input type="checkbox"/> Tuesday   08:00 <input type="checkbox"/> Wednesday   08:00 <input type="checkbox"/> Thursday   08:00 <input type="checkbox"/> Friday   00:00 <input type="checkbox"/> Saturday   00:00
<input checked="" type="checkbox"/> CLOSE	Weekly	<input type="checkbox"/> Sunday   18:00 <input type="checkbox"/> Monday   18:00 <input type="checkbox"/> Tuesday   18:00 <input type="checkbox"/> Wednesday   18:00 <input type="checkbox"/> Thursday   18:00 <input type="checkbox"/> Friday   00:00 <input type="checkbox"/> Saturday   00:00

## **Security**

The *Security* tab allows you to secure the browsing sessions between your computer and the Control Box's web interface using SSL encryption. Purchase and obtain an SSL certificate from a trusted certifying authority and click **Upload** in this page to apply the certificate.

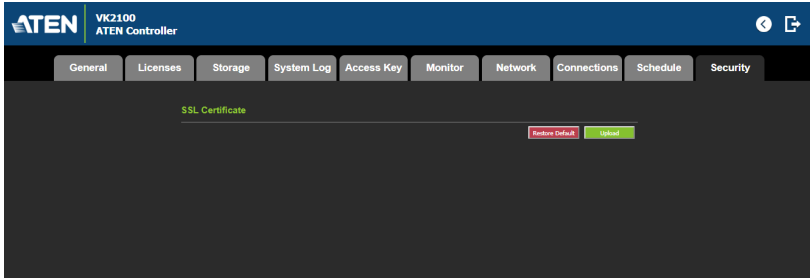

# Chapter 4

## ATEN Configurator (VK6000)

### Overview

---

The ATEN Configurator (VK6000) is a GUI-based management tool that helps you set up and configure the connected hardware and create control interfaces to be used by mobile devices and ATEN Keypads.

### Installation

---

To install the ATEN Configurator software, do the following:

1. Download ATEN Configurator.
  - a) Visit the ATEN download page.  
<http://www.aten.com/global/en/support-and-downloads/downloads/>
  - b) Search for “VK6000”. A list of downloads for VK6000 appear.
  - c) Click **ATEN\_configurator\_software\_x.x.xxx.zip** to download.
2. Open the downloaded zip file and double-click **ATEN\_configurator\_software\_x.x.xxx.exe** to run the setup. This screen appears.

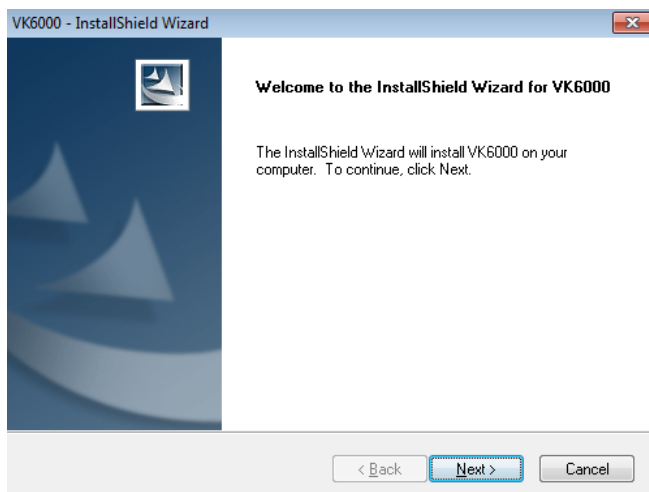

3. Click **Next**. This screen appears.



4. If you agree with the License Agreement, select **I accept the terms of the license agreement**, and click **Next**. Click **Print** to print the *Software End User License Agreement*. This screen appears.

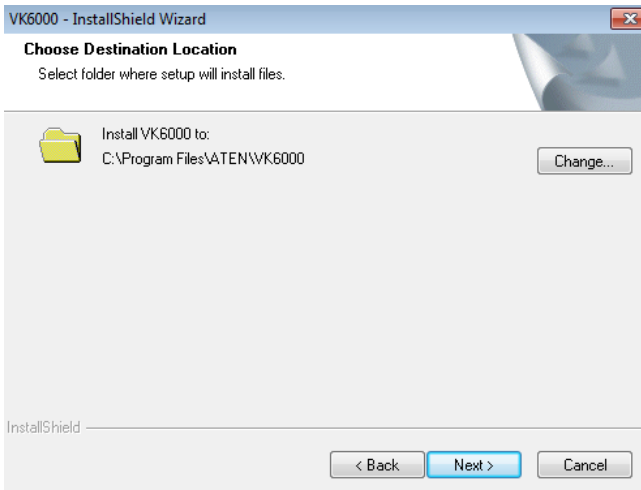

- To change the destination location, click **Change**. Click **Next** to proceed using the default location. This screen appears.

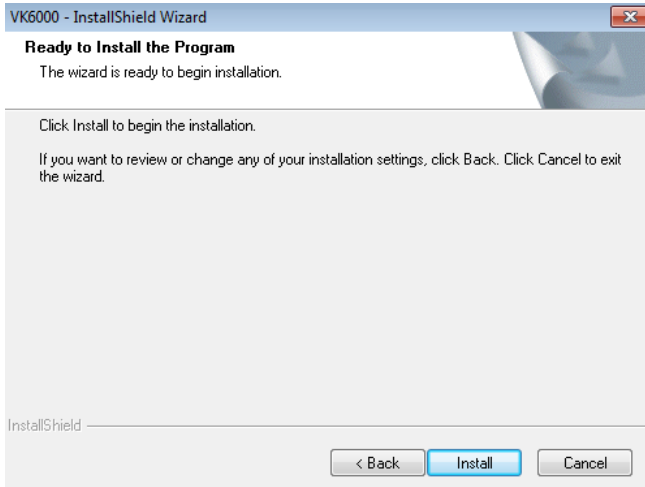

- Click **Install**. When the process is complete, a confirmation message appears.

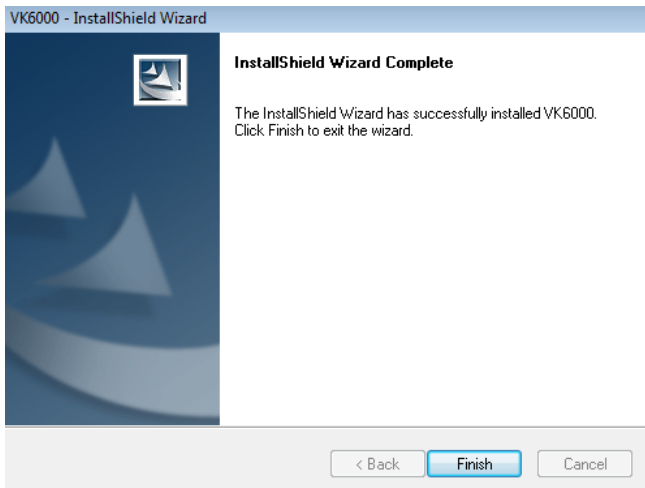

- Click **Finish**.

## Getting Started Tasks

After you have installed and launched the ATEN Configurator, the Main Page (page 60) appears. You will be guided to create and configure a project using the 4 tabs in the Configurator’s interface, as illustrated below.

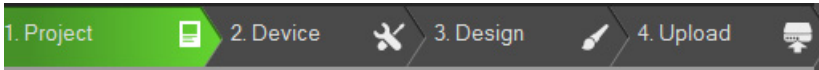

**Hint:** You can click the tabs to switch among different pages for configuration.

The steps below provides an overview of the getting started tasks.

1. In the **Project** tab, do the following.
  - ◆ Provide information on the ATEN Control Box (controller) that you have set up.
  - ◆ (Optional) Provide client information for the specified Control Box.
  - ◆ Click **Add Controller** if you have more than one Control Boxes in the environment.

For more details, see *Project*, page 67.

Click **Start Project** to proceed.

2. In the **Device** tab, do the following.
  - ◆ Connect each Control Box with its managed devices by adding them to the Control Box’s Device Configuration list, enter the connection settings, and specify the physical locations.
  - ◆ (Optional) Add another Control Box and/or Expansion Box to the project by clicking **Add Controller or Expander**.
  - ◆ Connect the Extension Box with its managed devices by adding them to the Extension Box’s Device Configuration list.

For more details, see *Device*, page 68.

Click **Design** or the **Viewer** tab to proceed.

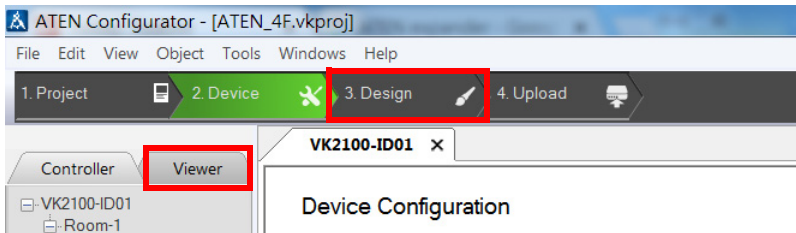



3. In the **Design** tab, do the following.
  - ◆ Create and configure a control interface (Viewer). For more information, see *Design*, page 82.
  - ◆ (Optional) Set up scheduled events to automatically carry out specified actions.
  - ◆ (Optional) Add additional conditions and actions to buttons using Flags. For details, see *Flag*, page 120.
  - ◆ (Optional) Create a sequence of actions for a button by creating a Macro. For details, see *Macro*, page 134.
  - ◆ (Optional) Create a Synced Variable for a device setting that is controlled by two or more components in one control interface. For details, see *Synced Variables*, page 137.
4. In the **Upload** tab, upload this profile to the Control Box. For details, see *Upload*, page 142.

# Main Page

Double-click the **Configurator.exe** shortcut to open the ATEN Configurator software. The *Project* page appears:

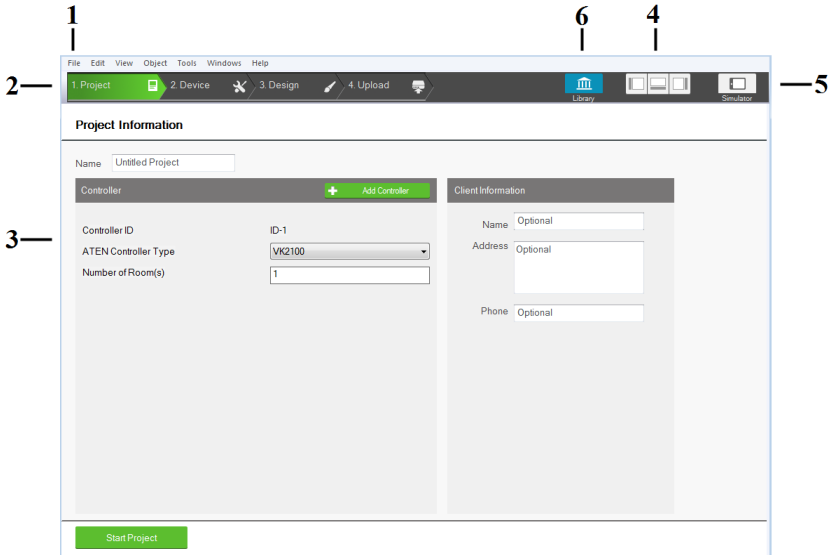

1	Menu bar	The <i>Menu Bar</i> contains categories with options that pertain to different sections of the software. Menu bar items are listed on page 61.
2	Project Bar	The <i>Project Bar</i> contains four tab and the Library icon. Each tab relates to a step required to setup the project profile. Each step and the Library can be selected by clicking on the bar. Each step is discussed, starting on page 67, and the Library on page 73.
3	Interactive Display Panel	This is the main work area. The page that appears here reflects the project tab that is selected.
4	Toggle Bar	These three icons are used as a toggle to show or hide the right, left and bottom control panel.
5	Simulator	The Simulator button is used to test a viewer's interface after it has been created in <i>Design</i> . The simulator allows you to tryout the interface as it would work on a mobile device but without actually controlling devices. Use the mouse to click through the page links.
6	Library	The Library contains the devices, object, macro, flag and monitor databases. Each section allows you to add custom items or choose from ready made selections.

## Menu Bar

Use the *Menu Bar* to select options in each project tab. The table below provides a description of each menu item.

Menu	Sub-Menu	Description
File	New Project	Select to create a new project.
	Open Project	Select to browse and open a previously saved project.
	Restore Project from Controller	Downloads a previously backed up project from a Control Box.
	Close	Closes the current project and returns to the Project tab.
	Save	Select to save changes to the current project.
	Save as	Use this option to save the project as a different name.
	Export Viewer to USB	Exports viewers and an access key to a USB drive. After exporting the data onto a USB drive, plug the USB drive into the Control Box's USB port to upload the viewer files and the access key. These files can only be read by the Control Box and are not project files that can be opened by the ATEN Configurator software.
	Project Report	Click to save a PDF file that contains detailed information about each part of the current project.
	Import ETS Project	Import an ETS project file for your KNX devices.
	Recent Projects	Select to view a list of recent projects that can be clicked on to open.
Exit	Select to close the project and exit.	

Menu	Sub-Menu	Description
Edit	Undo	Select to undo a change when editing a viewer page in <i>Create &amp; Design Viewer</i> .
	Redo	Select to redo a change when editing a viewer page in <i>Create &amp; Design Viewer</i> .
	Cut/Copy/Paste	Select to cut, copy or paste text and objects when editing a viewer page in <i>Create &amp; Design Viewer</i> . When used to copy and paste a button, both the <i>General</i> and <i>Action</i> properties are copied (see page 98).
	Paste Graphic Only	Select to paste a button's image but not its <i>Action</i> properties in <i>Create &amp; Design Viewer</i> .
	Delete	Select to delete highlighted text and images when editing a page in <i>Create &amp; Design Viewer</i> .
	Delete Action Only	Select to delete the <i>Action</i> properties of a button in <i>Create &amp; Design Viewer</i> .
	Select All / Deselect All	Use either option to select or deselect all objects when editing a viewer page in <i>Create &amp; Design Viewer</i> .
Preferences	Display Language	Use to select the language for the interface.
	SSH Destination	Click to choose the location of the executable for the SSH Client software. To execute the program, go to the menu bar and select <i>Tools</i> → <i>SSH Client</i> .
	Interface	Check a box to enable the feature described below: <ul style="list-style-type: none"> <li>◆ <b>Show Welcome Page:</b> displays the Welcome screen when the ATEN Configurator software opens.</li> <li>◆ <b>Show Upload Tip Screen:</b> displays a screen reminding you to set the Control Box ID before uploading profiles in <i>Search &amp; Upload</i>.</li> <li>◆ <b>Auto Page Creation:</b> automatically creates a viewer page in <i>Create Viewer &amp; Design</i>, for every hardware device that is configured in <i>Select Device &amp; Configuration</i>.</li> <li>◆ <b>Show Password:</b> displays the characters entered for the password in <b>Edit Access Key</b> from <i>Search &amp; Upload</i>.</li> </ul>

Menu	Sub-Menu	Description
View	These options are available from <i>Create Viewer &amp; Design</i> → <i>Edit Viewer</i> .	
	Zoom	Zooms the viewer page to 25%, 50%, 75%, 100%, 200% or Fit in Window. <b>Note:</b> A mouse wheel can be used to zoom the viewer page in or out.
	Project Information	Select to go to Project Information.
	Device Configuration	Select to go to Select Device & Configuration.
	Viewer Design	Select to go to Create Viewer & Design.
	Project Upload	Select to go to Search & Upload.
	Properties	Select to show/hide the Properties window when editing a viewer page.
	Align to Grid	Select to automatically align objects with the grid. This places objects in perfect alignment with the grid dots when they are moved. Use Show Grid to display the grid dots. When Align to Grid is not selected, objects can be placed anywhere on the page.
	Show Grid	Select to display the grid dots on the page. Use with the Align to Grid option to set objects in perfect alignment on the page.

Menu	Sub-Menu	Description	
Object	These options are available from <i>Create Viewer &amp; Design</i> → <i>Edit Viewer</i> .		
	Button	Adds a button to the viewer page.	
	Text	Adds a text box to the viewer page.	
	Image	Adds an image to the viewer page.	
	Scroll View	Adds a scroll box to the viewer page, then double-click it to add buttons. Use the box as a scroll window to easily access a list of buttons on the page.	
	Video	Adds a video box which allows you to view video. The video box can be resized using the Properties sidebar or by dragging a small box on the boarder to resize it to the desired shape.	
	Slider Bar	Adds a slider bar to the viewer page. Slider bars are used to adjust the value of a device setting, such as the volume level of an audio device.	
	PowerPoint Control Template	Adds a PowerPoint Control template to the Viewer. This control template is used to control PowerPoint files saved in a target computer.	
	Media Control Template	Adds a Media Control template to the Viewer. This control template is used to control media files saved in a target computer.	
	Group	Group	Select multiple objects and use <b>Group</b> to lock them together. Objects in the group will move together as one.
		Radio Group	Select multiple buttons and use <b>Radio Group</b> to associate them as follows: selecting a button that belongs to the radio group deselects the previously selected radio button within the same group.
		Ungroup	Select grouped objects and use <b>Ungroup</b> to unlock the group.
	Order	Bring to Front	Moves an object to the top position when objects are layered.
		Send to Back	Moves an object to the bottom position when objects are layered.
Bring Forward		Moves an object up one position when objects are layered.	
Send Backward		Moves an object down one position when objects are layered.	
Align	Left	Aligns two or more selected objects to the <del>Left side of the object that is selected last.</del>	

Menu	Sub-Menu		Description
	Make Same Size	Width	Resizes two or more selected objects to the same width of the object that is selected last.
		Height	Resizes two or more selected objects to the same height of the object that is selected last.
		Both	Resizes two or more selected objects to the same width and height of the object that is selected last.
	Space Evenly	Across Page Width	Spaces two or more selected objects evenly across the width of the page.
		Across Page Height	Spaces two or more selected objects evenly across the height of the page.
		Between Objects Horizontally	Adjusts the horizontal space between three or more selected objects to the average distance between each of the selected objects.
		Between Objects Vertically	Adjusts the vertical space between three or more selected objects to the average distance between each of the selected objects.
Tools	Database Generator		Opens the ATEN Database Generator which is used to manually add and configure hardware devices. This is where you can create custom devices to add to <i>My Device Library</i> . See <i>ATEN Database Generator</i> , page 145, for details.
	Simulator		The Simulator is used to test a viewer's interface after it has been created in <i>Design</i> . The simulator allows you to tryout the interface as it would work on a mobile device but without actually controlling devices. Use the mouse to click through the page links.
	SSH Client		This runs the SSH Client software selected under <i>Edit</i> → <i>Preferences</i> → <i>SSH Destination</i> . The SSH Client is used to communicate with the Control Box.
Windows	New Page		Click to create a new viewer page or select a page to open in <i>Create Viewer &amp; Design</i> .

<b>Menu</b>	<b>Sub-Menu</b>	<b>Description</b>
Help	About	Provides the firmware version and support information for the Configurator software.
	Check for Updates	Checks if ATEN Configurator is up-to-date.



## Project

The *Project* tab allows you to enter details about the installation to start the project. Enter the information using the table below as a guide.

Name	Enter the project name you are setting up. You can create multiple projects but for most installations only one project is required.
Add Controller	Click to add Control Boxes to the project. The number added should equal the number of Control Box units being installed. A project can have up to 16 Control Boxes. A Controller is the software link to the Control Box being installed.
Controller ID	Displays the Controller ID for the Control Box in the project. Use the Controller ID in the project to set the <b>Controller ID Switch</b> on the rear of the Control Box. The device configuration and viewer profile will be uploaded to the Control Box set with the same ID.
ATEN Controller Type	Select the Control Box model you are installing.
Number of Rooms	Enter the number of rooms each Control Box will control. Each hardware device you add will be associated with a room. When buttons are configured in the <i>Design</i> tab, you can select a <b>Room</b> under <i>Button Action</i> to filter the <i>Device</i> list so that only hardware in that room appears. This link between the Control Box, devices and room is how the viewer profile knows which devices to control.
Name	Enter the client name associated with the project.
Address	Enter the client address associated with the project.
Phone	Enter the client phone number associated with the project.
Remove Controller	Click to delete a Control Box from the project.
Start Project	Click to begin configuring hardware devices. The <i>Select Device &amp; Configuration</i> tab will open.

## Device

The *Device* tab is used to configure Control Box ports according to the connected hardware device.

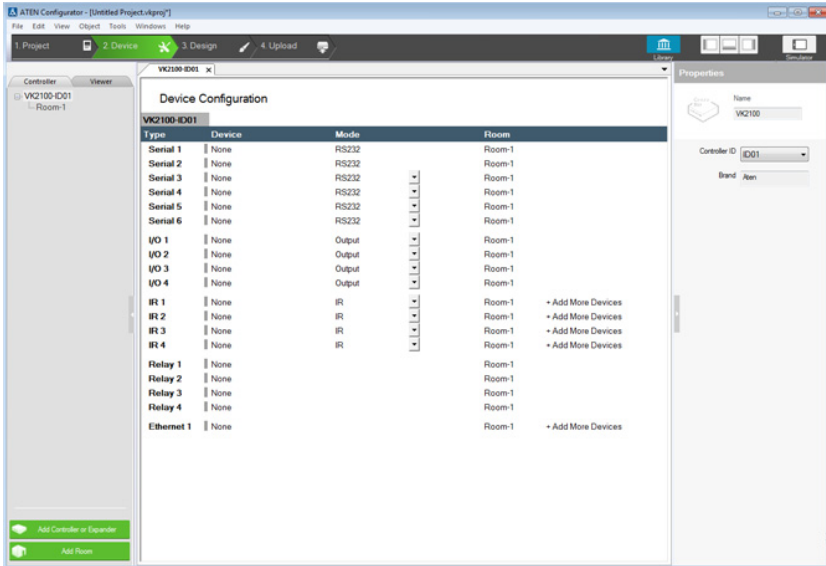

Device Configuration	This section lists the ports for each Control Box. Select a Controller, Expander or Room in the left sidebar to display the ports. Each port needs to be configured according to the hardware device connected to it (see page 68).
Left Sidebar	This section lists the Controllers, Expanders and Rooms. Use the sidebar to add a Control Box, Expander or Room. When a port is configured with a device, the device appears listed below the room on the sidebar (see page 71).
Library	Click this icon to open the <i>Library</i> on the <b>Device Library</b> tab which contains a database of hardware devices that are used to configure VK2100 ports (see page 73).
Properties	The <i>Properties</i> section displays information about the selected controller, port or room (see page 71).

## **Adding Devices to ATEN Configurator**

Add the devices managed by the Control Box to the Device Configuration list and configure their settings.

- ◆ To add KNX devices, follow the steps below:
  1. Click **File** and then **Import ETS Project**. The configurations for your KNX devices appear in the Controller tab on the left-side bar.
  2. In the Controller tab, click on **KNX IP Interface** and type its IP address and port in the Properties column.
- ◆ To add a device that is not KNX compliant, follow the steps below:
  1. In the Device Configuration list, select a port by clicking an entry or click **Add More Devices** to create a new entry.
  2. Click **Library** to find the device you want to add and double-click the entry to add the device. Proceed to the next step if the device is not in the Library.
  3. Create a device using the built-in Database Generator.
    - a) Follow the steps in *Edit / Add New Device*, page 149 to create the device.
    - b) In the Library window, click **Library** and select **My Device Library**.

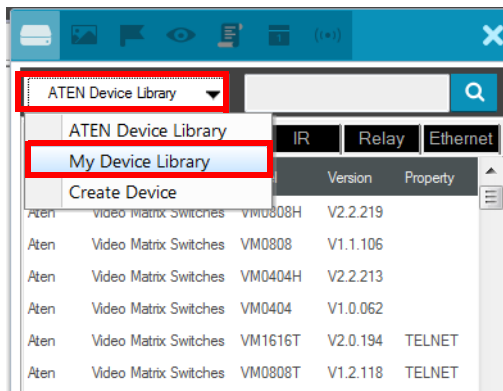

- c) Double-click the device you just created to add it to the Device Configuration list.

## The Device Configuration List

The *Device Configuration* page lists the Control Box ports by type. Click a port to view its **Properties** (page 71). Double-click a port to open the **ATEN Device Library** and search for the hardware device to configure the port. Configure each port according to the hardware device connected to it.

Type	Device	Mode	Room
Serial 1	None	RS232	Room-1
Serial 2	None	RS232	Room-1
Serial 3	None	RS232	Room-1
Serial 4	None	RS232	Room-1
Serial 5	None	RS232	Room-1
Serial 6	None	RS232	Room-1
I/O 1	None	Output	Room-1
I/O 2	None	Output	Room-1
I/O 3	None	Output	Room-1
I/O 4	None	Output	Room-1
IR 1	None	IR	Room-1 + Add More Devices
IR 2	None	IR	Room-1 + Add More Devices
IR 3	None	IR	Room-1 + Add More Devices
IR 4	None	IR	Room-1 + Add More Devices
Relay 1	None		Room-1
Relay 2	None		Room-1
Relay 3	None		Room-1
Relay 4	None		Room-1
Ethernet 1	None		Room-1 + Add More Devices

Type	Lists the VK2100 port type and number.
Device	Lists the device name entered in Properties.
Mode	Lists the port's communication mode. Click an arrow to select options: <ul style="list-style-type: none"> <li>◆ <b>Serial:</b> RS232, RS422, or RS485</li> <li>◆ <b>I/O:</b> Input (VDC), Input (Dry Contact) or Output</li> <li>◆ <b>IR:</b> IR or RS232</li> </ul>
Room	Lists the room selected for a device. The rooms available depend on the number of rooms added to the controller. No drop-down menu appears if there is only one room. Each controller must have at least one room. Select the room where the device is installed.
+ Add More Devices	RS422, RS485, LAN and IR ports can cascade additional devices that are connected to the first unit. IR ports can cascade 1 device, RS422 and RS485 ports can cascade up to 2 devices and LAN ports can cascade up to 25 devices.

## Left Sidebar

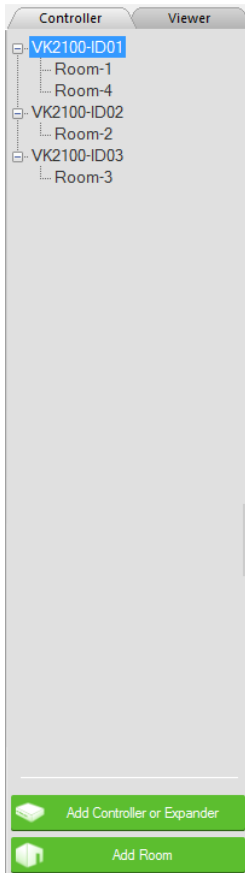

### Controller

The *Left Sidebar* provides a tree view of the controllers, expanders and rooms. Each controller represents a Control Box with the room(s) it manages. Selecting a controller allows you to configure its ports. When a port is configured for a device, it appears listed under the Room.

Each controller must have one room. When installing multiple Control Boxes in one room, add a room with the same name to each controller.

Each controller name ends with an ID number: VK2100-**ID01**. Use this number to set the **Controller ID Switch** on the rear of the Control Box. This links the controller in the software to the Control Box being installed.

Right-click a controller to **Add Room** or **Delete Controller**.

### Room

Rooms are associated with a controller and the viewer profile so that the information is uploaded to the correct Control Box to control the hardware devices.

Right click a room to **Delete** or **Rename** the room.

Use the buttons at the bottom of the sidebar to **Add Room**.

### Expander

ATEN Expansion Boxes connect over a network to add ports to the Control Box via its Ethernet port. Clicking **Add Controller or Expander** opens a window which allows you to select a device to add:





## Library

The Project Bar provides the **Library** option. Use the *Device Library* tab (shown right) to configure VK2100 ports according to the hardware device connected to it. The Device Library provides an extensive database of hardware devices that can be double-clicked or drag and dropped into the **Device Configuration** page to configure the VK2100 ports. The Device Library is discussed on the next page.

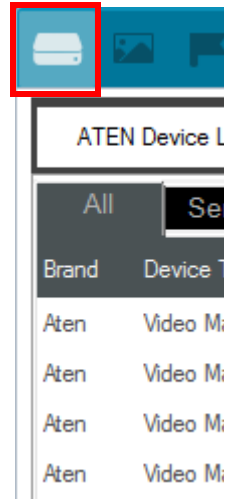



## Device Library

The *Device Library* tab is a database of hardware devices that instantly configure VK2100 ports. Search the library for the device connected to a VK2100 port then add it to configure the port. For devices not in the library, use the *ATEN Database Generator* to create custom hardware (see page 145). Click **Library** on the Project bar or double-click a port on the *Device Configuration* page to open the ATEN Device Library.

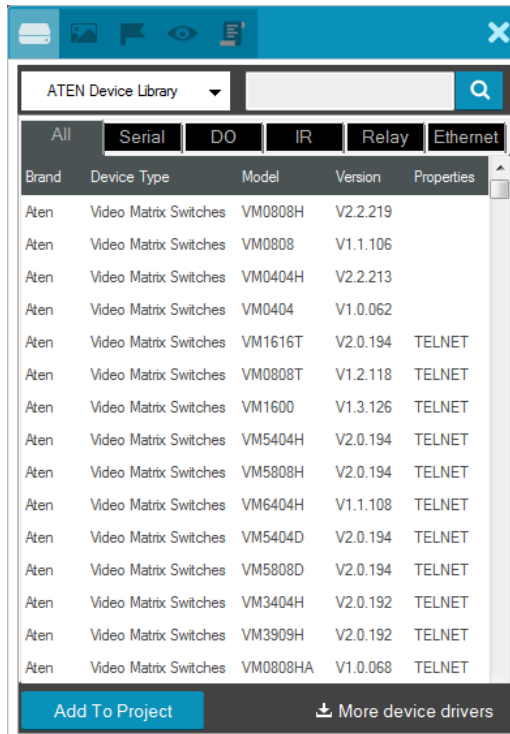

- ◆ Add a device by clicking **Add to Project** or by **drag & drop**.
- ◆ To search for a device type keywords into the box and click .
- ◆ Click a tab to filter by **All**, **Serial**, **DO**, **IR**, **Relay** or **Ethernet**.
- ◆ Click headings to sort by **Brand**, **Device Type**, **Model** or **Version**.
- ◆ Use the drop-down menu to select:
  - ◆ **ATEN Device Library** – ATEN’s database of hardware devices.
  - ◆ **My Device Library** – Devices added from the Database Generator.
  - ◆ **Create Device** – Opens the *Database Generator* to create custom hardware devices for *My Device Library* (page 145).

## Properties

The *Properties* sidebar displays information about the device selected. The information available depends on the device or port selected. The table below describes information shown for all types, followed by sections for types that include additional *Connection Settings* options.

Setting	Description
Name	Displays the device name and allows you to edit it.
Category	Displays the category of the selected device.
Brand	Displays the brand of the selected device.
Model	Displays the model of the selected device.
Version	Shows the firmware version selected for the device. Use the drop-down menu to select a different firmware version. Click the menu box next to the version number to open a PDF with the version history. The version history and different versions for a device can be manually added/updated via the Database Generator (see step 3 of <i>Edit / Add New Device</i> , page 149).
Connection Settings	Configure the parameters for the selected serial or Ethernet devices. For details, see <i>Serial Device</i> , page 75 and <i>Ethernet Device</i> , page 76 respectively.



Setting	Description
Advanced	Click <i>Advanced</i> and use the <b>Delay Interval</b> drop-down menu to set a timed delay for each command before it is sent to the device.
Add Custom	At the bottom of the Properties sidebar is <b>Add Custom</b> . Enter the name for a device and click <b>Add Custom</b> to reserve a VK2100 port for a new custom device.
Arrow Bar	Use the arrow bar on the left window frame to show or hide the Properties sidebar.

## ■ Connection Settings

### ◆ Serial Device

Provides drop-down menus to configure the **Baud Rate**, **Data Bit**, **Stop Bit**, **Parity** and **Flow Control** settings. Configure these options to match the serial device settings. Click **Advanced** to configure to

Click **Advanced** to configure the following parameters.

Delay Interval	Use the <i>Delay Interval</i> drop-down menu to set a time delay for each command before they are sent to the device.
Feedback Timeout	Sets the duration for receiving a feedback from the serial device before the Control Box times the session out.

- ◆ I/O Device

Two drop-down menus appear for *Input (VDC)* ports: **Lower Threshold** and **Upper Threshold**. Set the thresholds according to the hardware device you are connecting and then configure a *Monitor* (see page 122).

Lower Threshold

Upper Threshold

- ◆ Ethernet Device

These options allow you to configure the settings for a **PJLINK**, **TELNET**, **UDP**, **ONVIF**, **TCP**, **HTTP**, **HTTPS** device. Select the Protocol Type and then enter the IP Address, Port, Username and/or Password as required by the option you select. Each Control Box can add 25 LAN devices that connect through the Ethernet port. Use the *Protocol Type* drop-down menu to select:

- ◆ **PJLINK** – allows control of data projectors over a network using the PJLink protocol. Enter the IP Address, Port and Password of the LAN projector or device used to control the projector.

Protocol Type

IP Address

Port

Password

- ◆ **TELNET** – allows control of a LAN device via telnet commands. Enter the **IP Address**, **Port**, **Username** and **Password** of the telnet controlled LAN device. Use the **Advanced** Telnet options to configure the following parameters:

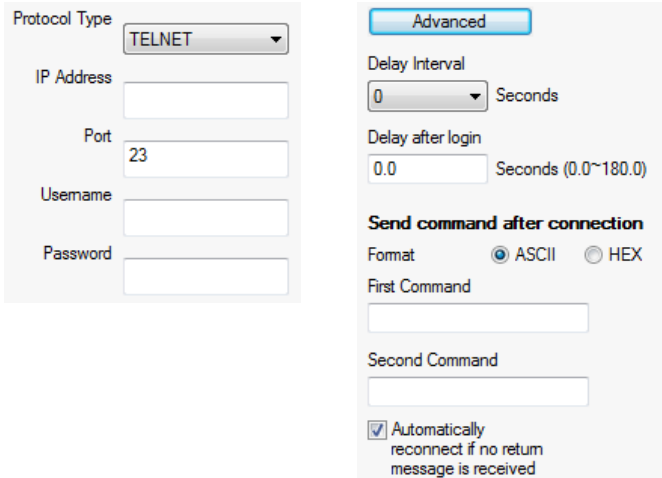

The screenshot shows the configuration interface for a TELNET connection. On the left, the 'Protocol Type' is set to 'TELNET'. Below it are input fields for 'IP Address', 'Port' (set to 23), 'Username', and 'Password'. On the right, the 'Advanced' tab is active, showing 'Delay Interval' set to 0 seconds, 'Delay after login' set to 0.0 seconds, and 'Send command after connection' options. The 'Format' is set to ASCII, and there are input fields for 'First Command' and 'Second Command'. A checkbox for 'Automatically reconnect if no return message is received' is checked.

Delay Interval	Use the <i>Delay Interval</i> drop-down menu to set a time delay for each command before they are sent to the device.
Delay after login	Sets a delay (to allow a connection to be established) before the <i>First</i> and <i>Second</i> Commands are sent to the device.
Send command after connection	Select the <b>Format</b> and enter a <i>First</i> and <i>Second Command</i> to send to the device after a successful connection has been established.
Automatically reconnect if no return message is received	Check this box if you want to continue reconnection attempts when no return message is received from the device.

- ◆ **ONVIF** – allows use of the ONVIF protocol which allows video from devices to be controlled and displayed through the ATEN Control System App. Enter the **IP Address**, **Username** and **Password** of the ONVIF device you are adding. Use the **Advanced** ONVIF options to configure Delay Interval:

Delay Interval	Use the <i>Delay Interval</i> drop-down menu to set a time delay for each command before they are sent to the device.
----------------	---

- ◆ **TCP** – allows control of a TCP LAN device. Enter the **IP Address** and **Port** of the device you are adding. Use the **Advanced** TCP options to configure the following parameters:

Delay Interval	Use the <i>Delay Interval</i> drop-down menu to set a time delay for each command before they are sent to the device.
----------------	---

Delay after login	Sets a delay (to allow a connection to be established) before the First and Second Commands are sent to the device.
Send command after connection	Select the <b>Format</b> and enter a <i>First</i> and <i>Second Command</i> to send to the device after a successful connection has been established.
Automatically reconnect if no return message is received	Check this box if you want to continue reconnection attempts when no return message is received from the device.

- ◆ **UDP** – allows control of UDP-compliant devices. Enter the IP Address and Port of the added device. Use the **Advanced** UDP options to configure Delay Interval:

The screenshot displays two panels for configuring UDP settings. The left panel, titled 'Connection Setting', contains a 'Protocol Type' dropdown menu with 'UDP' selected, an empty 'IP Address' text input field, and a 'Port' text input field containing the value '8000'. The right panel, titled 'Advanced', features a blue 'Advanced' button at the top, followed by a 'Delay Interval' dropdown menu set to '0' and the unit 'Seconds'.

Delay Interval	Use the <i>Delay Interval</i> drop-down menu to set a time delay for each command before they are sent to the device.
----------------	---

- ◆ **HTTP(S)** – allows control of HTTP or HTTPS devices. Enter the **IP Address**, **Port**, **Username**, and **Password** of the device you are adding. Specify the authentication type (**Auth Type**) using the drop-down list. Use the **Advanced** options to configure the following parameters:

The image shows two configuration panels. The left panel, titled "Connection Setting", contains the following fields: "Protocol Type" (dropdown menu showing "HTTP(S)"), "IP Address" (text input), "Port" (text input showing "80"), "Username" (text input), "Password" (text input), and "Auth Type" (dropdown menu showing "None"). The right panel, titled "Advanced", contains a "Delay Interval" dropdown menu showing "0" and the unit "Seconds".

Auth Type	Select the HTTP or HTTPS authentication type that the device uses.
Delay Interval	Use the <i>Delay Interval</i> drop-down menu to set a time delay for each command before they are sent to the device.

## ■ Controller

When you select a controller from the left side bar, the properties provides a drop-down menu to set the Controller ID (ID01~ID16). See *Controller ID*, page 67, for details.

The image shows the Controller configuration interface. It includes a "Controller Box" icon, a "Name" text input field containing "MK2100", a "Controller ID" dropdown menu showing "ID01", and a "Brand" text input field containing "Aten".

## ■ Expander

When you select an expander (VK224, VK236, VK248) from the left side bar, the properties provides a drop-down menu to set the Expander ID (ID01~ID08) and the option to configure the IP Address.

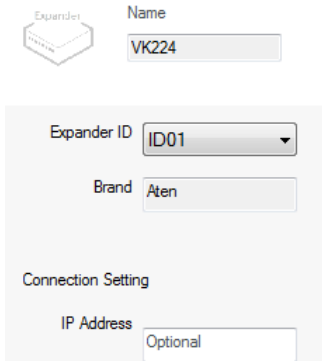

Expander

Name: VK224

Expander ID: ID01

Brand: Aten

Connection Setting

IP Address: Optional

To add an expander, click **Add Controller or Expander** on the left sidebar, then use the arrow and select an ATEN Expansion Box to add. The expansion box and ports will be listed on the *Device Configuration* page, as shown below:

VK224-ID01			
Type	Device	Mode	Room
Serial 1	None	RS232	Room-1
Serial 2	None	RS232	Room-1
Serial 3	None	RS232	Room-1
Serial 4	None	RS232	Room-1

# Design

The *Design* tab is for creating a **Viewer** – the user interface that controls the hardware from a mobile device or Keypad. Create a viewer and add the pages to control the hardware according to the setup you are installing.

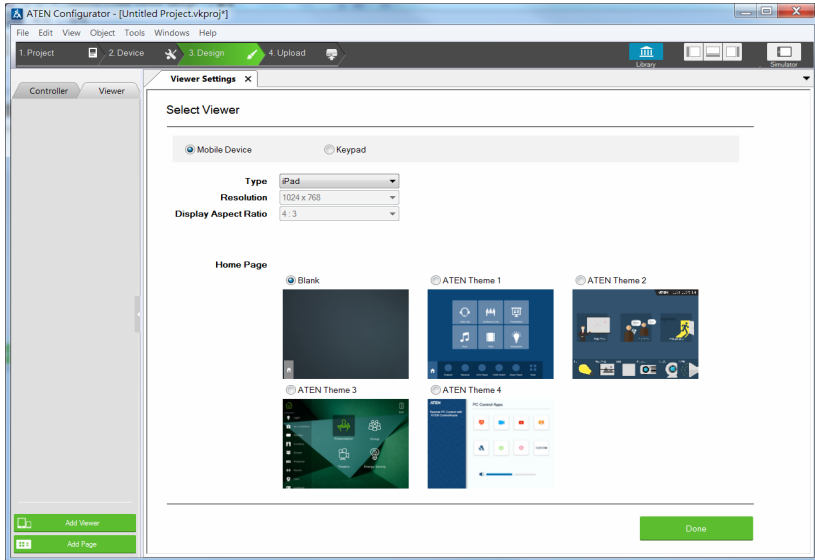

Viewer Settings	The <i>Viewer Settings</i> page appears if no viewer has been created so that you can set the Viewer Properties. The viewer properties must be set before you begin configuring the viewer's pages. When you are finished, click <b>Done</b> to begin designing the viewer pages. See <i>Select Viewer</i> , page 83, for details.
Left Sidebar	The left sidebar lists each viewer and its pages. The sidebar allows you to add viewers and pages. These options become available after clicking <b>Done</b> on the Viewer Settings page. See <i>Left Sidebar</i> , page 71, for details.
Library	Click this icon to open the <i>Library</i> which provides access to the <b>Graphic</b> (page 117), <b>Flag</b> (page 120), <b>Monitor</b> (page 122), <b>Macro</b> (page 134), <b>Scheduled Event</b> (page 136), and <b>Synced Variables</b> settings (page 137).
Simulator	The Simulator button is used to test a viewer's interface after it has been created. The simulator allows you to tryout the interface as it would work on a mobile device but without actually controlling devices. Use the mouse to click through the page links.
Select Viewer	The Select Viewer section allows you to configure the basic settings and type of viewer you want to create. See <i>Select Viewer</i> , page 83, for details.



## Select Viewer

The *Select Viewer* page sets the basic properties for the viewer that you create. A viewer is the interface designed for a mobile device or ATEN Keypad with the pages and buttons used to control each hardware device. Use the table below to select the viewer settings, and then click **Done** to continue.

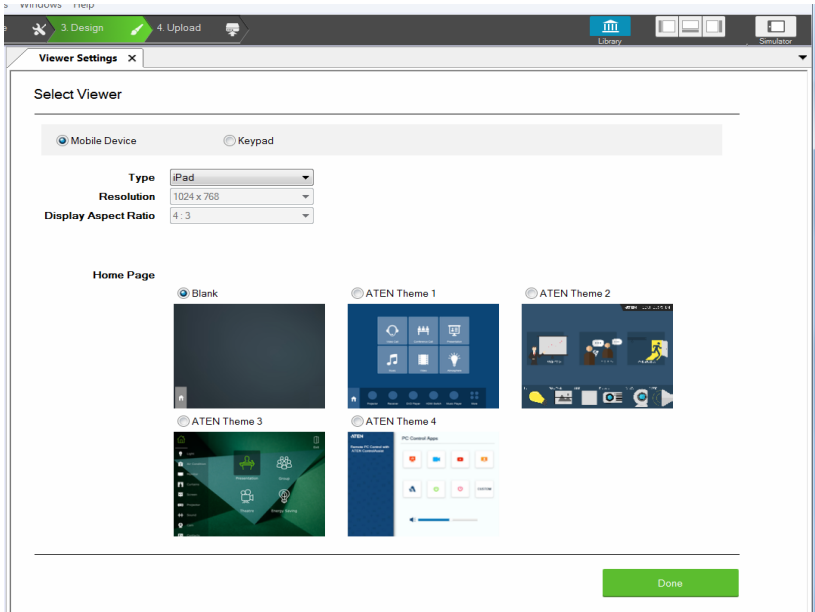

Select Viewer	<p>Displays the basic settings that must be selected to create a viewer profile.</p> <ul style="list-style-type: none"> <li>◆ <b>Mobile Device:</b> Select to create a viewer profile that will be uploaded for use on a mobile device.</li> <li>◆ <b>Keypad:</b> Select to create a viewer profile that will be used to configure buttons for a Keypad installation (see page 36).</li> </ul>
Type	<p>Use this drop-down menu to select the mobile device that will be used to control hardware devices in a room. This sets the resolution for the viewer to fit on the mobile device's screen.</p> <p>Choose a <b>Custom</b> selection to configure a screen size with the <i>Resolution</i> drop-down menu below it.</p> <p><b>Note:</b> If you select <i>Custom Windows Device</i> – the Windows OS has a limitation for adding buttons to the viewer pages on Windows mobile devices. See <i>Properties</i>, page 89, for details.</p>
Resolution	<p>Use this drop-down menu to set a custom screen resolution for the mobile device being used to control hardware devices. This option becomes available when you select one of the <i>Custom</i> selections from the <i>Type</i> drop-down menu. The <b>Display Aspect Ratio</b> menu is only provided as a reference and can not be set.</p>

Home Page	<p>Sets the layout for the Viewer's home page:</p> <ul style="list-style-type: none"> <li>◆ <b>Blank:</b> Creates a custom home page that you design from scratch.</li> <li>◆ <b>ATEN Theme 2:</b> Creates a home page and device page templates with graphics. Each theme provides a template that can be customized into your own design.</li> </ul>
Done / Replace	<p>Click <b>Done</b> to edit the Viewer pages. When you click <i>Edit Preferences</i> the <b>Replace</b> button appears to save changes.</p>

## Left Sidebar

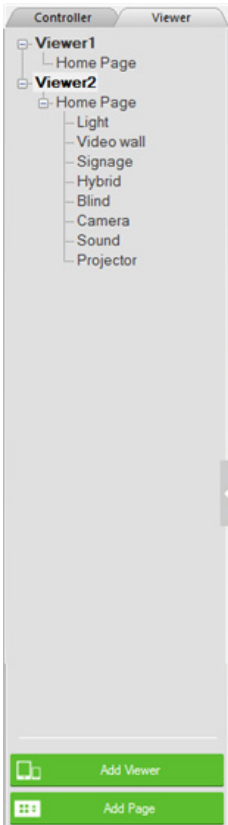

### Viewer

The *Left Sidebar* provides a tree view of the **Viewers** and **Pages**. Clicking a viewer opens the *Page Overview* which is a layout of the viewer's pages.

Right click a viewer to **Delete**, **Rename** or **Edit** the viewer.

Use **Add Viewer** at the bottom of the sidebar to create a new viewer.

### Pages

Each viewer lists the **Home Page** with each **Viewer Page** created for the viewer under it.

Clicking a Home or Viewer Page on the sidebar opens a new tab where the page can be edited.

Right click a page to **Delete** or **Rename** the page. The Home Page cannot be deleted.

Use **Add Page** at the bottom of the sidebar to add a page to the viewer.

## Right Sidebar

The *Right Sidebar* provides the **Properties** options which displays information and various settings for objects that are selected in the main window. The *Properties* sidebar will appear when a viewer page is open for editing and an object is selected. The *Properties* sidebar is discussed starting on page 74.

## Keypad

When you select the **Keypad** radio button on the *Select Viewer* page, configuration menus appear. The four drop-down menus allow you to configure the Keypad layout and ID settings. After clicking **Done**, the viewer page will open allowing you to configure the Keypad's label and buttons.

The screenshot shows the 'Select Viewer' configuration page in the ATEN Configurator. At the top, there is a tab labeled 'Viewer Settings' with a close button. Below the tab, the 'Select Viewer' section has two radio buttons: 'Mobile Device' (unselected) and 'Keypad' (selected). Under the 'Keypad' selection, there are four dropdown menus: 'Model' (set to VK108US), 'Number of Keys' (set to 8 Keys), 'Layout' (set to Type 1), 'Controller ID' (set to VK2100-ID01), and 'Keypad ID' (set to VK108US-ID01). Below these menus is a green 'Add Keypad' button. To the right of the dropdowns is a diagram of a keypad layout, showing a 2x4 grid of keys with the ATEN logo below it. At the bottom right of the page is a green 'Done' button.



Type	Select the type of Keypad that you are installing.
Layout	Click to define the Keypad layout. This setting should match the physical Keypad layout for the installation (see page 41 for details).
Controller ID	Select the ID number of the Control Box (Controller) that the Keypad will connect through. This ID must match the Control Box ID Switch (black) set on the Keypad (see page 40).
Keypad ID	Select the ID number to match the Keypad ID Switch (blue) set on the Keypad (see page 40). Up to 8 Keypads can connect to one Control Box.
Add Keypad	Click <b>Add Keypad</b> to add another Keypad that will connect to the same Control Box and control the same set of devices.
Done / Replace	Click <b>Done</b> to edit the Viewer page for the Keypad. When you click <i>Edit Preferences</i> , the <b>Replace</b> button appears to save changes.

## Page Overview

When you select **Mobile Device** or **Keypad** on the *Select Viewer* page and click **Done**, *Page Overview* appears with a preview of the viewer pages that control the hardware. From here you can edit and delete pages created for the viewer profile.

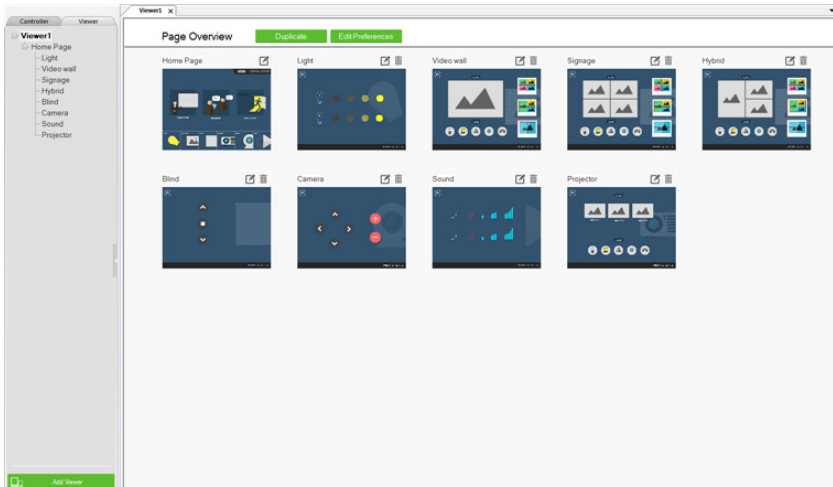
Edit and add pages to design the layout that will be used to control hardware from a mobile device or keypad. Each page can be fully customized with macros and buttons to control different hardware devices and with any object, background, size, shape and color of your choice. For keypads, a layout will be automatically created allowing you to configure the labels and buttons.



Page Overview	Shows the <b>Home Page</b> and each <b>Control Page</b> that you add to the Viewer.
Duplicate	Click <b>Duplicate</b> to create a copy of the selected viewer and its pages. A new viewer will appear in the left sidebar.
Edit Preferences	Click <b>Edit Preferences</b> to enter the <i>Select Viewer</i> page (see page 83). This allows you to change the viewer's basic settings. To return to Page Overview, click Done.
	Click the <b>Edit</b> icon to customize a viewer page (see page 87).
	Click this icon to delete the viewer page. The viewer's Home Page can not be deleted.
Add Viewer	Click <b>Add Viewer</b> from the left sidebar to create a new viewer.
Add Page	Click <b>Add Page</b> from the left sidebar to add a new page to the viewer. Pages can only be added to <i>Mobile Device</i> viewers.
Viewer Sidebar	See <i>Left Sidebar</i> , page 84, for details.

## Edit

Clicking the **Edit** icon of a viewer page (see page 86) allows you to customize the layout and design. You can add buttons\*, labels, images, scroll view windows, and slider bars to the page.

Buttons can be made into a **Link**, **Macro** or **Function** (page 98).

Use the **Library** on the Project Bar to design the layout and buttons using *Graphics* (page 117); or configure *Flags* (page 120), *Monitors* (page 122) and *Macros* (page 119) for button actions. Objects can be layered, images can be imported and labels can be applied anywhere.

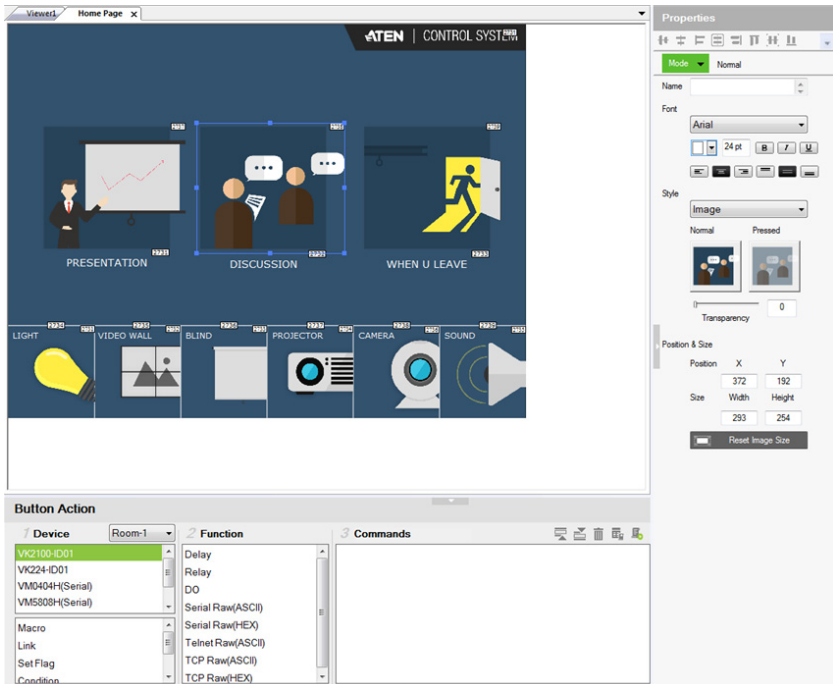

**Note:** The Windows OS has a limitation when adding buttons to viewer pages for use on Windows mobile devices. See *Windows OS Button Limitation*, page 88, for details.

- ◆ Right click on the page to add an object: **Button**, **Label**, **Image**, **Scroll View**, **Video**, **Slider Bar**, **PowerPoint Control**, and **Media Control Template**.
- ◆ Select an object to open **Properties** on the right side.

- ◆ Select a button or slider bar to open **Action** on the bottom.
- ◆ Drag and drop objects anywhere on the page.
- ◆ Right click on an object to set **Order** options to layer objects.
- ◆ Click the mouse wheel to zoom the page in or out.
- ◆ Click the **Library** icon on the Project Bar to open the *Graphic, Flag, Monitor or Macro* libraries.
- ◆ Select and right-click multiple objects to **Group** or **Align** objects.
- ◆ Use the *View* menu options to select **Show Grid** and **Align to Grid** to set objects in perfect alignment.

### Windows OS Button Limitation

When adding buttons to a viewer page for use on a Windows mobile device there is a Windows OS limitation for overlapping buttons. When two buttons are layered (A) on top of (B), the top most button (A) can not be pressed – instead (B) is activated each time. To resolve this issue, duplicate the top most button (A) and add it (C) directly under (A) and below (B) on the viewer page.



When the top button (A) is pressed, the lowest button (C) will execute the action.

## Page Objects

A number appears at the top right corner of each object. The numbers are assigned in sequence, in the order that the object is added. These numbers help identify a label when configuring a **Change Label** (page 111) or a button when configuring a **Change Button State** (page 110).



Each button has a symbol in the top left corner to indicate:

- ◆ “A” the button’s actions are configured correctly.
- ◆ “!” the button’s actions need to be modified or they will not work.
- ◆ Buttons with no symbol indicate that functions have not been added to it.  
For details on adding functions, see *Button / Slider Bar Action*, page 98.

## Properties

The *Properties* side bar provides alignment buttons for when multiple objects are selected allowing you to arrange them accordingly:



## ■ Page Properties

The *Page* properties provides an option to change the background image.

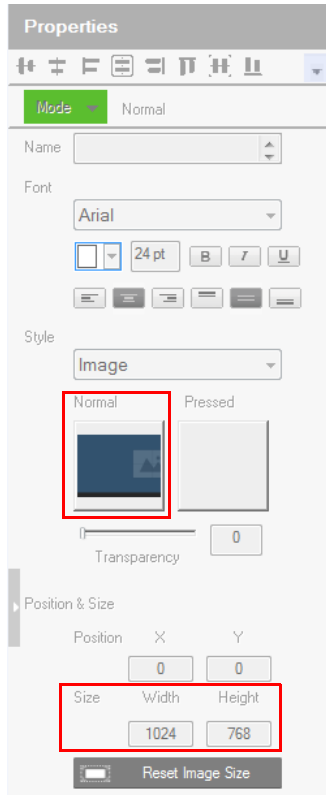

- ◆ **Style** – click the *Normal* box to import an image (\*.png,\*.jpg\*.jpeg\*.bmp) to use as the background for the page.
- ◆ **Position and Size** – displays the *Width* and *Height* of the page according to the *Resolution* set in the *Viewer Properties*. This option can not be changed.



## ■ Button Properties

The *Button* properties provide options to configure the appearance of a button, and the confirmation message and progress message before carrying out the associated action.

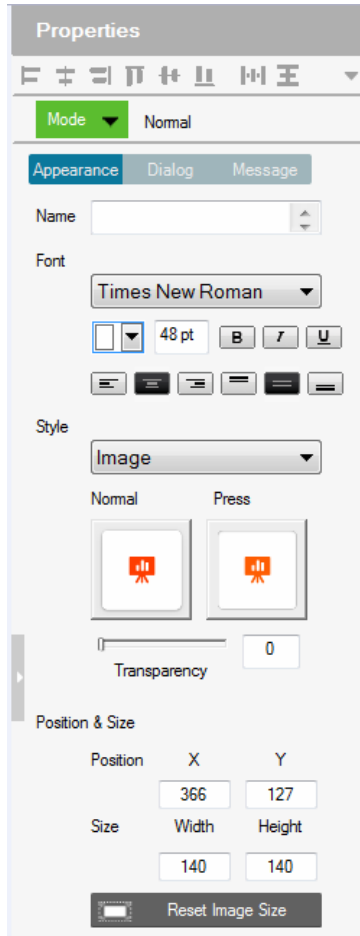

### ◆ Mode

Use this drop-down menu to select one of the following button types.

- ◆ **Normal** – This is a button that stays the same when pressed.
- ◆ **Toggle** – for a button that switches between two images/colors to indicate the button status. This also splits the Commands list under **Button Action** (page 98) – to provide two commands for the button: Toggle ON and Toggle OFF.

- ◆ **Press and Release** – for a button that switches between two images/ colors when pressed and released. This splits the Commands list under **Button Action** (page 98) to provide two commands for the button: Press and Release.
  - ◆ **Long Press** for a button that switches between two images/colors when pressed and released. This button continuously re-sends a command to a device as long as it is pressed, at the **Interval** specified (see *Interval*, below) and stops sending the command once the button is released.
  - ◆ Use the **Normal** and **Pressed** option to set the image or color of the button according to its state.
- ◆ **Appearance**

Click the **Appearance** tab to configure the look of the button.

**Note:** The Appearance settings are applicable to all button modes. However, the **Appearance** tab only exists for Normal and Toggle buttons to categorize different sets of settings.

- ◆ **Name** – (optional) type the text you want to use for the button (or slow double-click the button on the viewer page).
- ◆ **Font** – use the drop-down menu to select the font type.
  - ◆ **Color** – use the drop-down menu to change the color of the text.
  - ◆ **Size** – enter a number (1-200) to set the size of the text for the button.
  - ◆ **Format** – formats text to *Bold*, *Italic* or *Underline* for the button.
  - ◆ **Alignment** – click a box to align the text Right, Center or Left; and Top, Middle or Bottom within the button box.
- ◆ **Style** – use the drop-down menu to select the style type.
  - ◆ **Normal** imports an image to use as the button's standard background and click *Pressed* to import an image to use when the button is pressed.
  - ◆ **Color** allows you to use drop-down menus to select the buttons color for Normal and Pressed.
  - ◆ **Transparency** – enter a number (0-100) or use the slider-bar to set the transparency of the button.
- ◆ **Send Command Every** (Long Press mode buttons only) – use the drop-down menu to select the amount of time between each command that is sent (repeatedly) to the device while the button is pressed.

- ◆ **Position and Size** – *X* and *Y* position the button at the coordinates entered. *Width* and *Height* set the size of the button box. Click **Reset Image Size** to reset the button size.
- ◆ **Dialog**

Click the **Dialog** tab to set up a confirmation message that displays in the viewer when the button is pressed.

**Note:** The Dialog settings are only available for Normal and Toggle buttons.

  - ◆ **Confirm the associated action with the following message when the button is pressed** – Click the check box to enable this feature.
  - ◆ **Action** – Select a button action (**Toggle On** or **Toggle Off**) to display the confirmation message.
  - ◆ Content drop-down list – Select one of the following for customization.
    - ◆ **Background** – Customize the wording for the confirmation message. Type the message in the **Name** field and optionally customize its font and style.
    - ◆ **OK** – Customize the wording on the button for carrying out the associated action. Type in the **Name** field and optionally customize its font and style.
    - ◆ **Cancel** – Customize the wording on the button for canceling the associated action. Type in the **Name** field and optionally customize its font and style.
- ◆ **Message**

Click the **Message** tab to set up a progress message that displays while the associated action is being carried out.

**Note:** The Message settings are only available for Normal and Toggle buttons.

  - ◆ **Confirm the associated action with the following message when the button is pressed** – Click the check box to enable this feature.
  - ◆ **Action** – Select a button action (**Toggle On** or **Toggle Off**) for displaying the progress message.
  - ◆ Content drop-down list – Select one of the following for customization.
    - ◆ **Background** – Configure the wording for the progress message. Type the message in the **Name** field and optionally customize its font and style.
    - ◆ **Progress Bar** – Configure the display duration (in seconds), font, and color of the progress indicator.

## ■ Label Properties

The *Label* properties provide options to change the text formatting of a label.

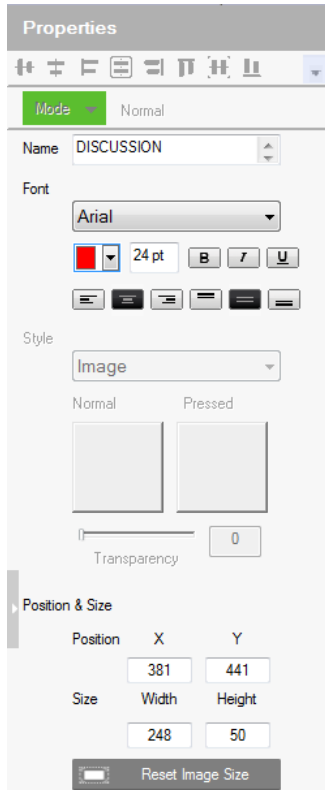

- ◆ **Name** – enter the text you want to use for the label or slow double-click the label on the **Edit** page.
- ◆ **Font** – use the drop-down menu to select the font type.
  - ◆ **Color** – use the drop-down menu to change the color of the text.
  - ◆ **Size** – enter a number (1-200) to set the size of the text.
  - ◆ **Format**– format text to *Bold*, *Italic* or *Underline*.
  - ◆ **Alignment** – click a box to align the text Right, Center or Left; and Top, Middle or Bottom within the label box.
- ◆ **Position and Size** – *X* and *Y* position the label at the coordinates entered. *Width* and *Height* set the size of the label.

## ■ Properties for Slider Bars

The *Slider Bar* properties provide options to configure a Slider Bar. Right click on a viewer page and select **Slider Bar** to add a bar. A Slider Bar can control a device, link to another page, or run a macro. The Slider Bar properties are discussed on the next page.

Mode
Basic Slider Bar

---

Name

Font

10 pt
  B
 I
 U

Direction

Vertical  
 Horizontal

Style

Foreground Color

Background Color

Knob



Transparency

Value

ASCII     HEX

Minimum     Maximum

Level

The change value will be averaged by calculating:  
 (Maximum Value - Minimum Value) / Levels

Position & Size

Position    X                      Y

Size        Width                      Height

Reset Image Size

- ◆ **Mode** – use the drop-down menu to select the button type:
  - ◆ *Basic Slider Bar* for a bar where you enter the minimum and maximum values to calculate the range and levels on a slider bar, and then add one command to configure the Basic Slider Bar’s action (See *Slider Value*, page 103). Choose options under **Value** to configure the slider bar’s range:
    - ◆ *ASCII / HEX* – click a radio button to select the format for the slider bar values.
    - ◆ *Minimum* – enter the lowest level on the bar.
    - ◆ *Maximum* – enter the highest level on the bar.
    - ◆ *Level* – this represents the number of levels on the slider bar. You can calculate the value of each level with the formula: **Maximum Value - Minimum Value / Level = Value Per Level**. The *Level* is automatically calculated according to the Minimum and Maximum values you enter.
  - ◆ *Advanced Slider Bar* for a bar where you set the number of levels and add a command for each level in the bar (see *Level*, in the table, on page 98). Choose options under **Value** to configure the slider bar’s range:
    - ◆ *Level* – this represents the number of levels on the slider bar. For each level you must add a separate command in the **Slider Bar Action – Commands** list (see *Level*, in the table, on page 98).
- ◆ **Direction** – sets the bearing of the slider bar. Options are *Vertical* or *Horizon*.
- ◆ **Style** – click the drop-down menus to select the *Foreground Color* and *Background Color* for the slider bar.
- ◆ **Value**
  - ◆ String format – Specifies the string format for the managed device to **ASCII** or **HEX**.
  - ◆ **Minimum** – Sets the minimum value of the slider bar.
  - ◆ **Maximum** – Sets the maximum value of the slider bar.
  - ◆ **Level** – Sets the total number of levels for the slider bar.
- ◆ **Position and Size** – depending on whether the bar is set Vertical or Horizontal you can use either the *Size*: **Width** or **Height** box to enter a number to resize the length of the slider bar.

## ■ Properties for PowerPoint Control Templates and Media Control Templates

Click a PowerPoint control template or a media control template to configure its position, size, and the PC that controls it.

**Properties**

Mode: Normal

Name:

Font: Arial

10 pt

Style: Image

Normal Press

Transparency: 0

Position & Size		
Position	X	Y
	441	15
Size	Width	Height
	216	166

Reset Image Size

Select Device: ControlAssist

- ◆ **Position and Size** – X and Y position the label at the coordinates entered. *Width* and *Height* set the size of the label.
- ◆ **Select Device** – Select the PC that stores the PowerPoint or media files using the drop-down list.



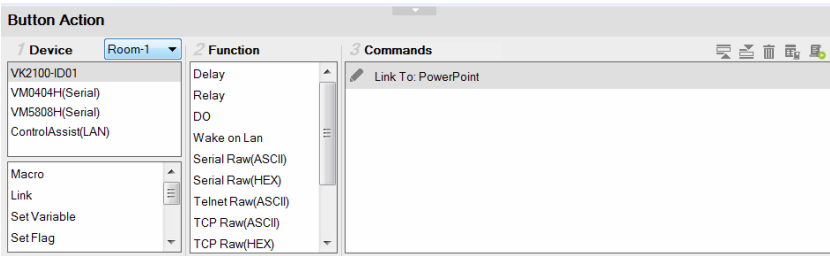

## Button / Slider Bar Action

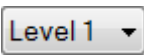

The *Button Action* is used to set what a button does when pressed. Select a button on the viewer page to configure the Button Action. Use the table below for an overview and the instructions on the next page to add *Commands* and *Advanced Options* to a button's action.

Device	Lists the devices and advanced options that can be selected to add commands to the Button Action. When one is selected, commands appear in the Function list. The upper box lists hardware, the lower box <i>Advanced Options</i> .
Room	Select the room that the viewer will control devices in. Use this drop-down menu to select rooms in the KNX system and display KNX devices. The viewer will only upload to a Control Box configured with the same Room name (see <i>Left Sidebar</i> , page 71). Select <b>All Rooms</b> to allow the viewer to control all rooms. Selecting All Rooms will upload the viewer profile to all Control Boxes.  The Accessible Room defines what <b>Devices</b> are available to configure new <b>Actions</b> in Button Properties (see page 98). Only <i>Devices</i> listed under the same <i>Room</i> (see page 71) as the viewer's Accessible Room will be listed for use in Button Properties.
Function	Lists commands that can be added to the Commands list. When a device or option is selected, commands in the Function list can be added to the Commands list to configure the button's action(s).
Commands	Lists the commands that will initiate when the button is pressed. <i>Device</i> and <i>Advanced Option</i> functions can be added and associated in the Commands list together. Commands initiate in the order that they are added to the list. Right-click in the Commands list to use the menu selections: <i>Move Up</i> , <i>Move Down</i> , <i>Copy</i> , <i>Paste</i> , <i>Delete</i> , <i>Save as Macro</i> , or <i>Test Tool</i> .
Toggle ON / Toggle OFF or Press / Release	When the Button <b>Mode</b> (page 91) is set to <i>Toggle</i> or <i>Press and Release</i> , the <i>Commands</i> list splits to set the two c commands:  <b>Toggle ON / Press</b> – lists the commands that initiate when the button is first pressed or pressed and held.  <b>Toggle OFF / Release</b> – lists the commands that initiate when the button is pressed a second time (Toggle), or released (Press and Release). When the button is pressed again, <i>Toggle ON</i> initiates and the cycle repeats.



	The Level drop-down menu appears when an Advanced Slider Bar is selected on the viewer page. The number of levels in the drop-down menu reflect the <b>Level</b> set in the <i>Advanced Slider Bar's</i> properties (page 96). Use the drop-down menu to select a level and then add a command for each of the Advanced Slider Bar's levels (see page 104 for details).
	Use <b>Move up</b> to move an action up in the Commands list, or <b>Move down</b> to move an action down in the Commands list.
	Use <b>Delete</b> to remove an action from the Commands list.
	Use <b>Save as Macro</b> to save the commands in the Commands list as a macro.
	Use <b>Test Tool</b> to connect to a Control Box and test the action(s) in the Commands list.

## Adding Commands

The *Button Action* section allows you to add and configure commands – to set what a button does when pressed. You can configure a button with **Device** commands (On, Off, Stop, Play, etc.); as a **Macro** to send multiple commands to one or more devices; or as a **Link** to other viewer pages. *Advanced Options* allow you to add conditions to the commands, as described on the next page.

To add a command to the button:

1. Under **Device**, select a **Room** and then an option.
2. Select a command from the **Function** list.
3. Double-click the command to add it to the **Commands** list.

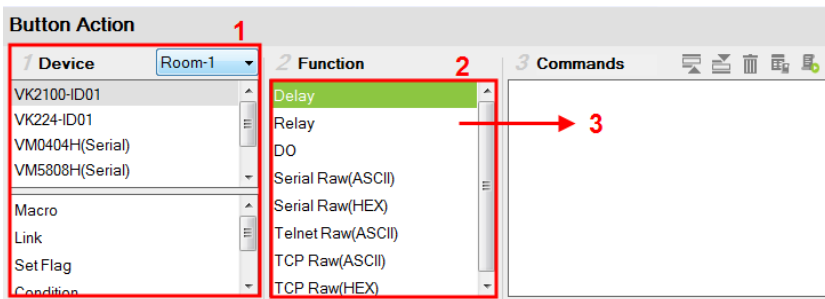

The commands listed under **Function** depend on which option is selected in the **Device** list.

4. Use the information below to understand how each **Button / Slider Bar Action** section works and how to add *Advanced Option* to commands.
  - ◆ **Device** – lists hardware devices and advanced options that can be selected to add commands to the Commands list. Commands appear in the *Function* list. Only hardware devices from the **Room** that is selected (via the drop-down menu) are listed here. The controller is listed first and allows you to add *Special* commands, as explained under *Function*, on page 102. In addition to hardware device commands, you can add options:

**Macro** – sends multiple commands to one or more devices. Select to add a macro command from the *Function* list. To create a macro, add multiple device actions to the Commands list, then click the **Save as Macro**  icon or access the function by clicking the *Library* icon (page 119).

**Link** – makes the button into a link that directs you to a viewer page. Select to add a page link from the *Function* list. Double-click the page link in the Commands list to select a different page link.

Below lists **Advanced Options** that provide features to add conditions to button commands. For more information on these options, see *Advanced Options*, page 104.

**Set Variable** – creates a variable for a device setting (e.g. volume) that is controlled by two or more UI components (e.g. slider bar or buttons) in the viewer. When the device setting is changed through one of the components, its setting is automatically synced and reflected on all components. For details, see *Synced Variables*, page 137.

**Set Flag** – sets a flag value to represent the new device status when a command changes a device setting. Set Flags are added to the Commands list after device commands to change the Flag (device status).

**Condition** – adds a condition that must be met for commands to initiate. A condition's set value must be *equal to* a **Flag** or **Feedback** value for the command(s) below it to initiate. Conditions are added before commands in the Commands list.

**Change Button State** – this command changes the image of another button when this button is pressed – allowing the image of any other button to change when the command from this button is sent. Change Button State is added to the end of the Commands lists. When adding this to a **Toggle** button it allows the image to switch with the toggle behavior: *Normal* or *Pressed*. In this situation the Change Button State is added to the end of both the **Toggle ON** and **Toggle OFF** Commands lists.

**Change Label** – this option changes a label's text with text that you enter manually or with text from a device's return message. A Manual Change Label can be added to the beginning or end and with a Condition in the Commands list. Adding it to a Condition guarantees the label only changes when the command initiates.

**Change Group Button State** – this option adds a command that changes the button selected in a **Radio Group** (page 64). Create a Radio Group and then a Function will be listed for it when *Change Group Button State* is selected. Add the *Change Group Button State* to the *Commands* list of a button and use the drop-down menu to select the button in the Radio Group you want selected.

**Change Slider Bar Level** – this option adds a command that changes the level of a **Slider Bar** (page 95). Create a Slider Bar and then a Function will be listed for it when *Change Slider Bar Level* is selected. Add the *Change Slider Bar Level* to the *Commands* list of a button and use the drop-down menus to select the **Slider Bar** and **Level** to change.

- ◆ **Function** – lists the commands that can be added to the *Commands* list. Select an option under **Device**, then double-click or drag & drop commands from the *Function* list to add them to the *Commands* list.

Associate **Set Flag**, **Condition**, **Change Button State**, or **Change Label** commands with device commands in the *Commands* list by dragging and dropping them into a tree view list, which allows them to initiate together (see *Advanced Options*, page 104).

If you select the controller from the **Device** list, you can add the *Special* commands listed below. Double-click to add, and then double-click to configure:

**Delay** – adds a delay in seconds. Enter a number between 0.1-180.

**Relay** – adds an Open, Close, Toggle or Pulse action on the selected controller and Relay port.

**DO** – adds an Open, Close, Toggle or Pulse action on the selected controller and Digital Output port.

**Wake on LAN** – powers on the specified computer (MAC address) over Ethernet.

**Serial Raw (ASCII)** – adds a serial command in the ASCII mode.

**Serial Raw (HEX)** – adds a serial command in the HEX mode.

**Telnet Raw (ASCII)** – adds a telnet command in the ASCII mode.

**TCP Raw (ASCII)** – adds a TCP command in the ASCII mode.

**TCP Raw (HEX)** – adds a TCP command in the HEX mode.

**UDP Raw (ASCII)** – adds a UDP command in the ASCII mode.

**UDP Raw (HEX)** – adds a UDP command in the HEX mode.

**HTTP** – adds an HTTP command.

**HTTPS** – adds an HTTPS command.

- ◆ **Commands** – lists the commands that initiate when the button or slider bar is used. They can include *Device Commands* (on, off, switch, change setting or volume, etc.) and *Conditions* (Flag, Feedback) that must be met before a command can initiate; or *Changes* (Set Flag, Change Button State, Change Label, Change Group Button State, or Change Slider Bar Level) that initiate with device commands.

When a device command has multiple values you can double-click it and use the **Show Flag Menu\*** to select a device setting.

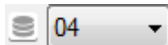
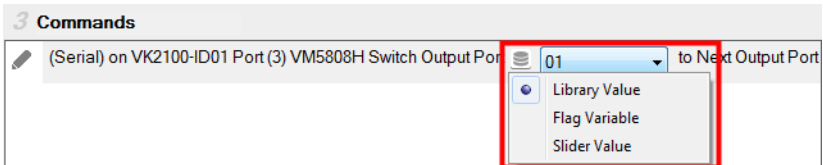

**Library Value** – use the drop-down menu to select a device setting for the command. The selection of settings in the drop-down menu can be modified using the Database Generator to edit the command string (see *Edit / Add New Device*, page 149).



**Flag Variable** – clicking this button allows a Flag with a set of values to be selected for the action. The button's action will select a setting according to the Flag value. Each value in a Flag can be set to a different device using a Set Flag (as a button to select the device). When that (Set Flag) button is pressed, the Flag value is set for that particular device, and will be used as the setting for this action, when it's button is pressed.

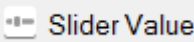

**Slider Value** – select this option to configure a *Basic Slider Bar's* command. The range and change levels are automatically configured according to the minimum and maximum values set for the Basic Slider Bar (page 95). This option only appears when a *Basic Slider Bar* is selected on the viewer page and you are adding **Slider Bar Action** commands.

---

**Note:** The Show Flag Menu allows you to use a single Flag for all devices rather than adding a Conditional Flag for each device.

---

Level 1 ▾

**Level** – When an *Advanced Slider Bar* is selected on a viewer page, the Level drop-down menu appears above the *Commands* list. A command must be added to each level of an Advanced Slider Bar. To configure each level, use the drop-down menu to select a level and then add a command to it.

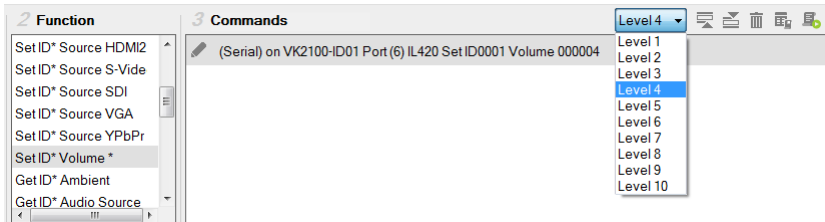

## Advanced Options

Advanced Options allow you to include conditions with commands in the Commands list. Associate **Set Flag**, **Condition**, **Change Button State** or **Change Label** functions with a command in the Commands list by dragging and dropping them into a tree view listed with the command, so that they initiate in the order listed.

- ♦ **Set Flag** – add a Set Flag to change a Flag’s value when a command changes a device setting. This sets the **Flag** value to match the new device setting (e.g. ON or OFF). Always add a **Set Flag** to a **Condition Flag**, after the device action(s):

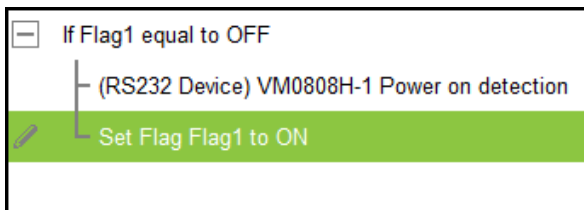

To add a Set Flag:

1. Under **Device**, select **Set Flag**.
2. From the Function list, select the **Flag**.
3. From the **Function** list, drag and drop the **Flag** to add it to the end of the *Condition Flag*, in a tree view list:

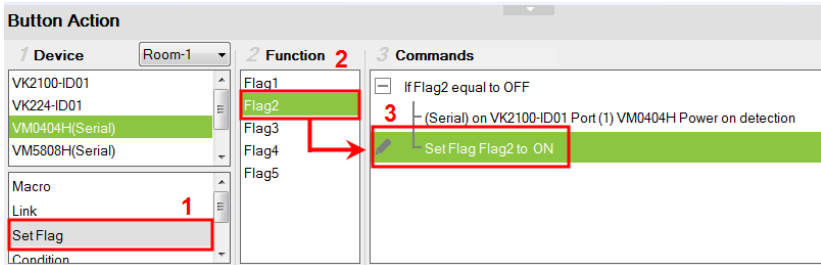

4. Double-click **Set Flag** in the Commands list to use the drop-down menus to set the **Flag** and **Value**.

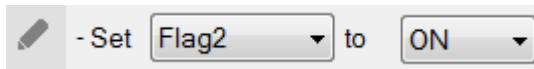

- ◆ **Condition** – adds a condition that must be met before the commands listed with it can initiate. When the button is pressed, the Condition's set value must equal the **Flag** or **Feedback** value for the command(s) to initiate. There are two condition types: **Flag** and **Feedback**.
- ◆ **Flag** – adds a condition based on a Flag's value. "If **Flag** equals **Value**" is true, the condition is met and the commands listed with the Condition will initiate. Always add a **Condition Flag** at the top of the Commands list, drag and drop the device command(s) and then a Set Flag at the end, in a tree view list:

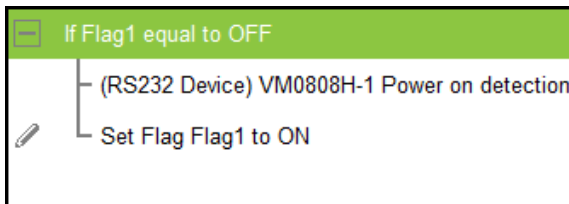

To add a Condition Flag:

1. Under **Device**, click **Condition**.
2. From the Function list, select **Flag**.
3. Double-click **Flag** to add the Condition Flag to the **Commands** list.

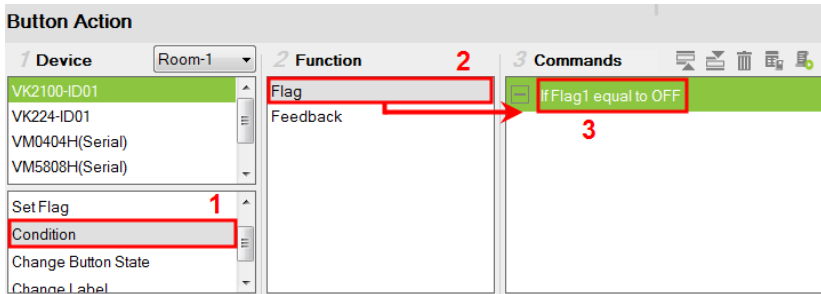

4. Double-click the **Condition Flag** in the Commands list to use the drop-down menus to set the **Flag** and **Value**.

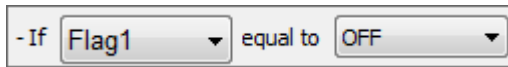

5. From the **Function** list, drag & drop device commands to add them to the **Condition Flag**, in a tree view list:

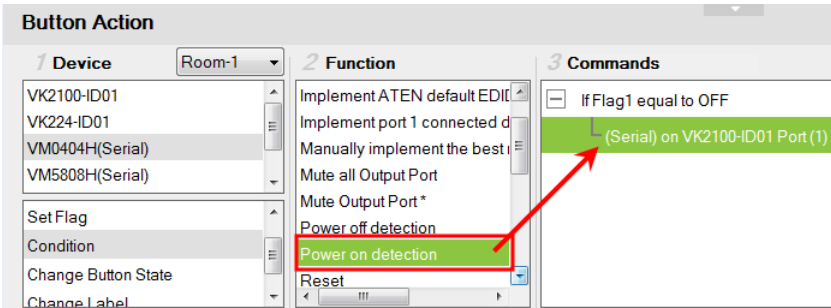



6. Add a **Set Flag** after the last device command in the **Commands** list:



- ♦ **Feedback** – adds a condition based on the **text** from a serial/telnet/TCP device's return message. Always add a **Condition Feedback** to a serial/telnet/TCP command, with command(s) added below the Condition Feedback, in a tree view list:

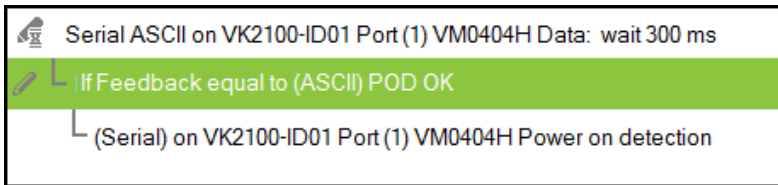

**Receive Time** – when a Feedback condition is added to a device command the **wait** to *Receive Time* drop-down menu appears allowing you to set the amount of time to wait before it stops receiving the return message from the device.

There are three Condition Feedback types:

- ♦ **Equal** – when the text sent from a serial/telnet/TCP device's return message matches **all of the text** entered for a **Condition Feedback Equals**, the commands listed below it will initiate.
- ♦ **Include** – when the text sent from a serial/telnet/TCP device's return message matches **part of the text** entered for a **Condition Feedback Include**, the commands listed below it will initiate.
- ♦ **Bypass** – this option bypasses matching text from the serial/telnet/TCP return message and initiates a **Change Label** command. The label's text will change to the return message sent from the device (i.e. the *Feedback Result*). A **Change Label** must be added to the **Feedback Bypass** for it to work.

To add a Condition Feedback Equal/Include:

1. Under **Device**, click **Condition**.
2. From the Function list, select **Feedback**.
3. From the **Function** list, drag and drop **Feedback** to add it to the Serial/Telnet/TCP command, in a tree view list:

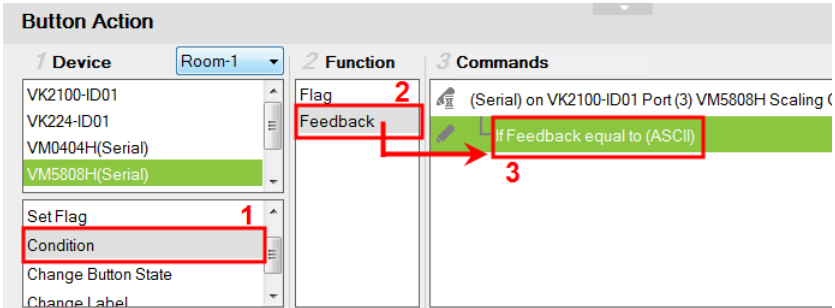

4. Double-click **If Feedback equals to** in the Commands list and use the drop-down menu to select **equal to** or **include** and enter the **Text**.



Text entered here must match **all** (equal to) or **part** (include) of the text from a serial/telnet/TCP device's return message for the command(s) to initiate. Use the **ASCII / HEX** drop-down menu to select the format.

5. From the **Function** list, drag & drop device command(s) to add them to the **Feedback Equal/Include Condition**, in a tree view list:

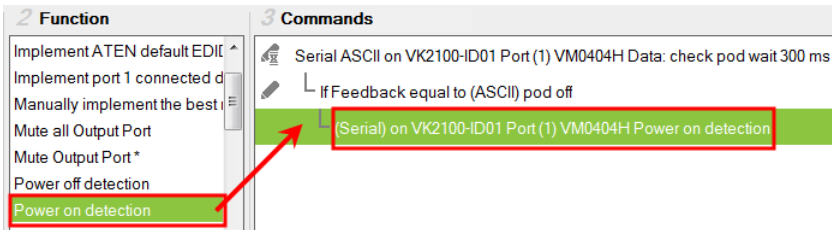

To add a Feedback Bypass Condition with Change Label:

1. Under **Device**, click **Condition**.
2. Select **Feedback** from the Function list.
3. From the **Function** list, drag and drop **Feedback** to add it to the Serial/Telnet/TCP command, in a tree view list:

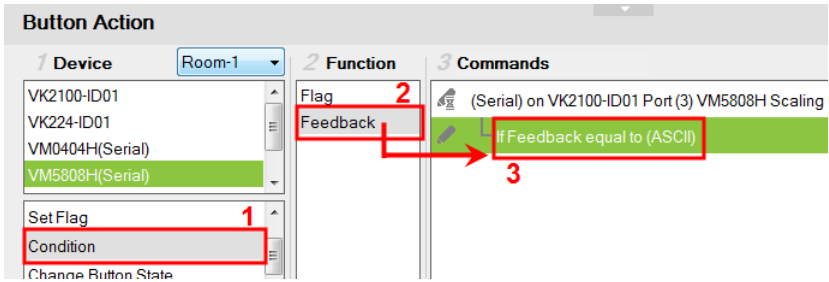

4. Double-click **If Feedback equals to** in the Commands list and use the drop-down menu to select **bypass**.

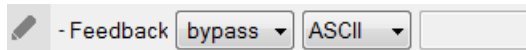

5. Under **Device**, select **Change Label**.
6. From the Function list, select the **Viewer Page** where the label is located.
7. From the Function list, drag and drop the **Viewer Page** to add it to the **Feedback Bypass Condition**, in a tree view list:

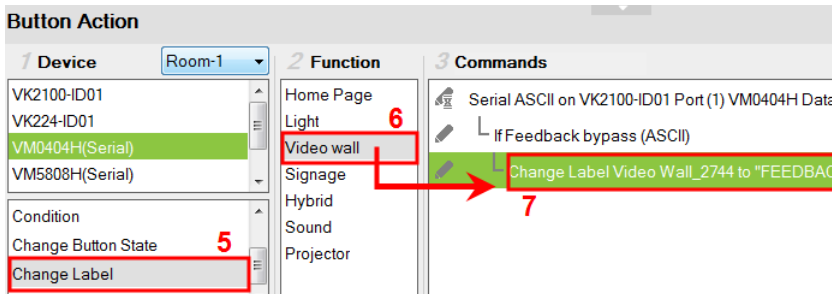

8. Double-click **Change Label** in the Commands list and use the drop-down menu to select a label. Labels are identified by number (see page 89).

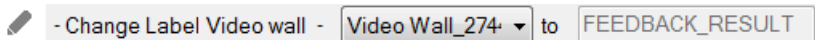

The label's text will change to the serial/telnet/TCP device's return message.

- ♦ **Change Button State** – this option is used to change another buttons image when this button is pressed – allowing the button image to switch depending on the status: *Normal* or *Pressed*. Change Button State is added to the end of the Commands lists and should point to a **Toggle** button. Adding this to a **Toggle** button allows the image to switch with the toggle behavior: *Normal* or *Pressed*.

To add a Change Button State:

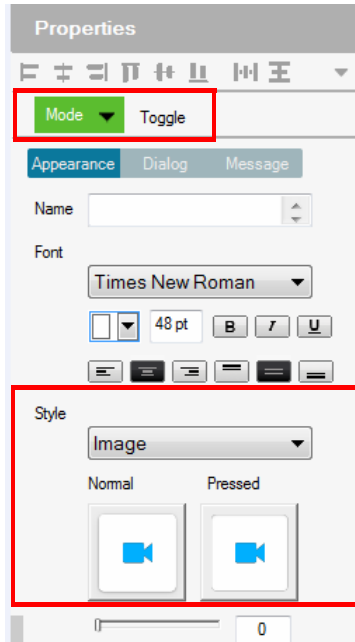

1. Under **Properties**, use the **Mode** drop-down menu to select a button type.
2. Under **Style**, click the **Normal** and **Pressed** button to select an image/color\* for the button's state.

---

**Note:** Use the *Style* drop-down menu to select **Image** to import an image file for the button state, or **Color** to choose a color format for the button state.

---

3. Add the Toggle ON and Toggle OFF device commands to the Commands lists.
4. Under **Device**, select **Change Button State**.
5. In the Function list, select the **viewer page**.

6. Select the **Toggle ON** radio button, then in the Function list, double-click the **viewer page** to add it to the end of the *Toggle ON* commands in the Commands list.
7. Select the **Toggle OFF** radio button, then in the Function list, double-click the **viewer page** to add it to the end of the *Toggle OFF* commands in the Commands list.

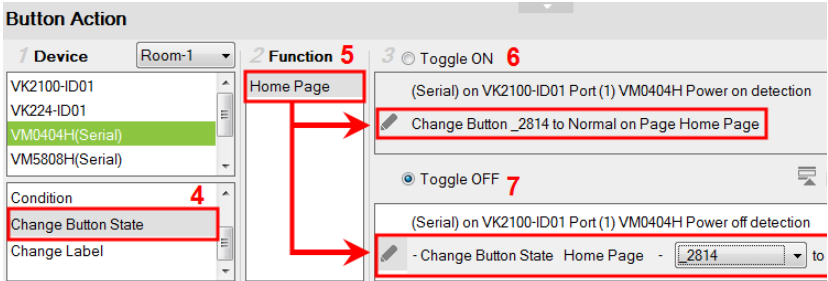

8. In each Commands list, double-click the **Change Button State** command to set the **Button** and **State** (*Normal* or *Pressed*).

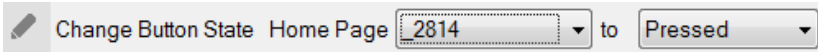

- ◆ **Change Label** – changes a label’s text with text that you enter manually or with text from a serial/telnet/TCP device’s return message (*Feedback Result*). A **Change Label** that uses a return message, must be added to a Feedback Bypass Condition (page 108). A **Manual Change Label** can be added anywhere in the Commands list. Adding it to a Condition guarantees the label changes only when the command initiates.

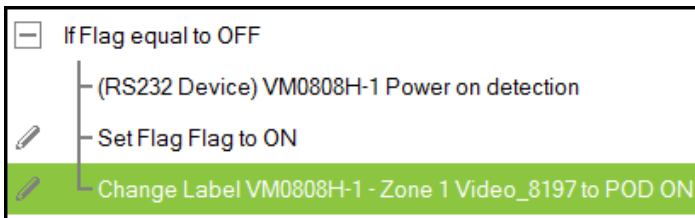

To add a Manual Change Label:

1. Under **Device**, click **Change Label**.
2. In the Function list, select the **viewer page** where the label is located.
3. Double-click or drag and drop the **viewer page** to add the Change Label to the **Commands** list.

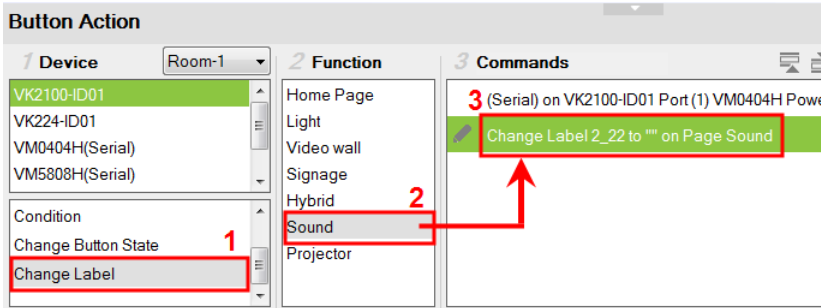

4. Add a **Change Label** to *multiple* or *Toggle ON / Toggle OFF* Command lists to have the same label change text for different actions.
5. In the Commands list, double-click **Change Label** to use the drop-down menu to select a **Label** and input the **Text**. This is the text in the label that will appear when the button is pushed.

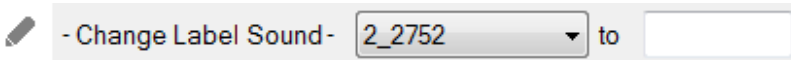

Repeat the steps to add a Change Label for the reverse action (i.g., **On** and **Off**).

- ◆ **Change Group Button State** – adds a command that changes the selection in a *Radio Group* (see page 64). To use this function, first create a *Radio Group* and then add a button to the viewer page. Add a **Change Group Button State** independently or with a device command:

To add a Change Group Button State:

1. Under **Device**, select **Change Group Button State**.
2. From the **Function** list, select the **Viewer Page** where the Radio Group is located.
3. From the **Function** list, drag and drop the **Viewer Page** to add it to the *Commands* list:

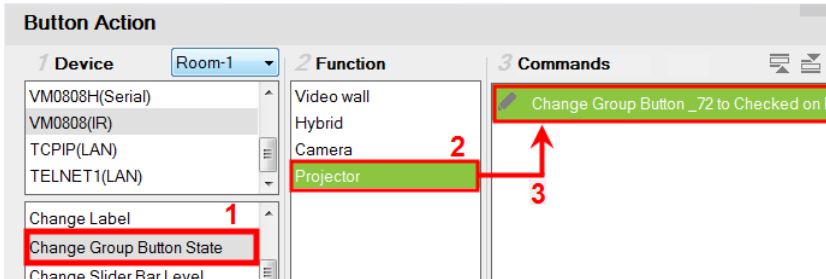

4. Double-click **Change Group Button** in the *Commands* list and use the drop-down menu to select the **Button**.

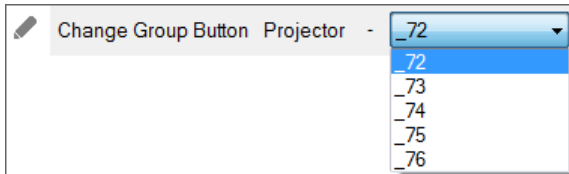

- ◆ **Change Slider Bar Level** – adds a command that changes the level of a *Slider Bar*. To use this function, first create a *Slider Bar* on a viewer page. Add a **Change Slider Bar Level** independently or with a device command:

To add a Change Slider Bar Level:

1. Under **Device**, select **Change Slider Bar Level**.
2. From the **Function** list, select the **Viewer Page** where the Slider Bar is located.
3. From the **Function** list, drag and drop the **Viewer Page** to add it to the **Commands** list:

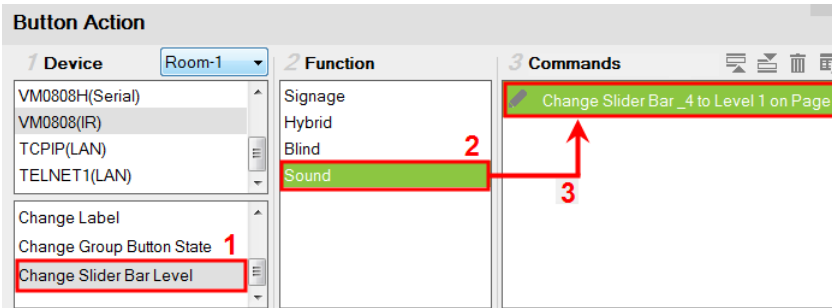

4. Double-click **Change Slider Bar** in the **Commands** list and use the drop-down menus to select the **Slider Bar** and **Level**.

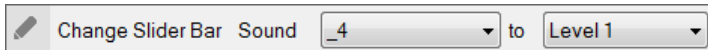



## ■ Image Properties

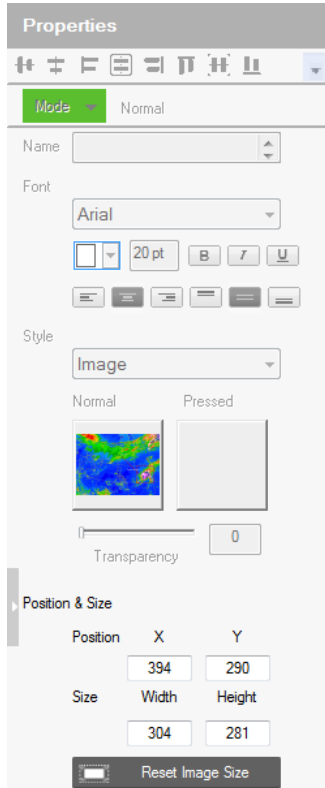

The **Properties** for an image provide options to change and import images to the page. Images can be layered with other objects so that they can be placed as a background or as highlights for buttons (see *Layering Images*, page 116). You can **Group**, **Order**, **Align**, **Make Same Size** or **Space Evenly** from the *Object* menu.

---

**Note:** For imported images, make sure the file names contain English alphabets and/or numerals only.

---

- ◆ **Style** – shows the image selected. Click inside the box to import an image (\*.png, \*.jpg, \*.jpeg, \*.bmp) to the page.
- ◆ **Transparency** – enter a number (0-100) or use the slider-bar to set the transparency of the image selected.
- ◆ **Position and Size** – *X* and *Y* position the image at the coordinates entered. *Width* and *Height* set the size of the image.
- ◆ **Reset Image Size** – resets the image size.

## Layering Images

Images can be layered with other objects, such as labels and buttons, so that they can be placed as a background or as highlight for the page and/or other objects.

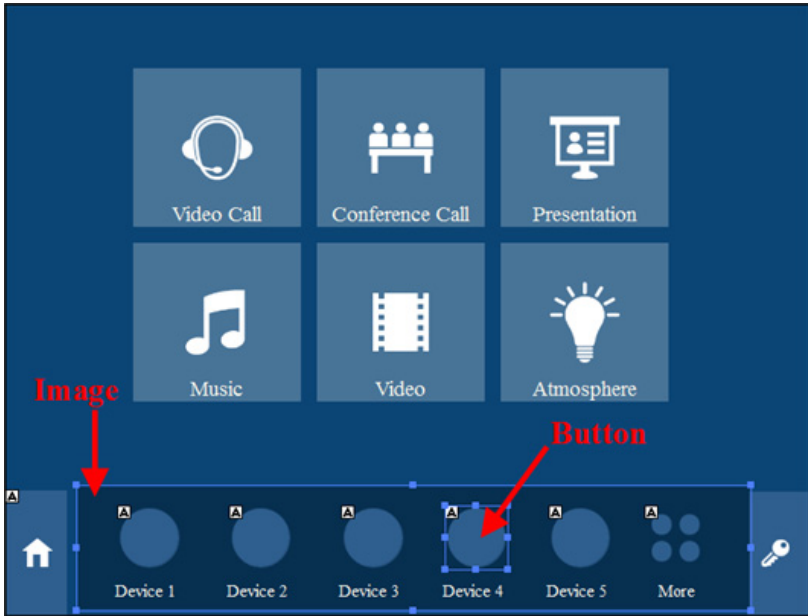



## Graphic Library

The **Library** icon on the Project bar provides a *Graphics* tab and drop-down menus with ready-to-use graphics for backgrounds, buttons, icons and device interfaces. Device Interface provides entire page layouts that you can use as templates for different types of devices. Double-click or drag and drop graphics to add them to the page. Images can be imported for icons and buttons in various formats (\*.png,\*.jpg,\*.jpeg,\*.bmp).

## Background Color

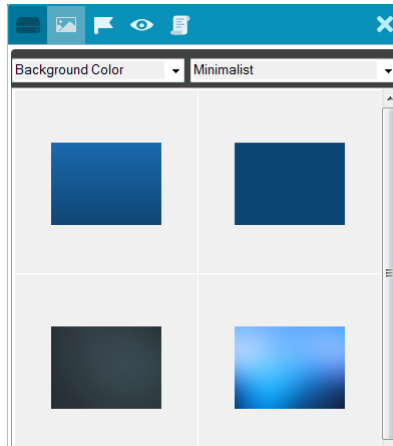

## Button

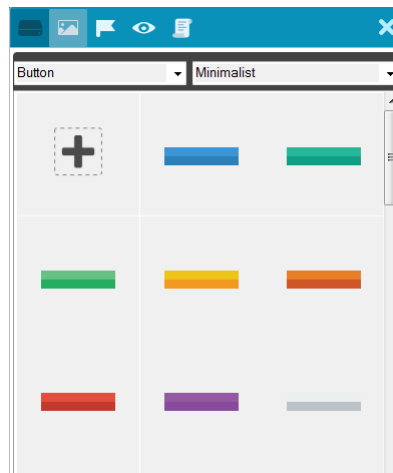

## Icon

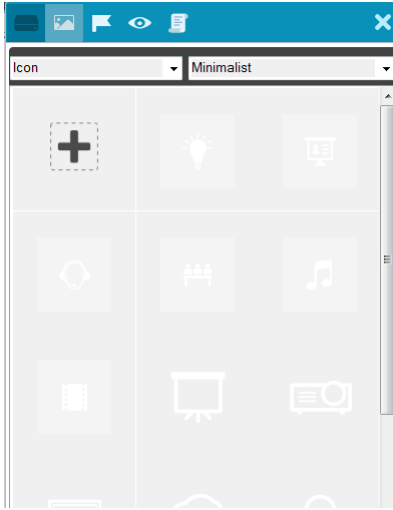

## Device Interface

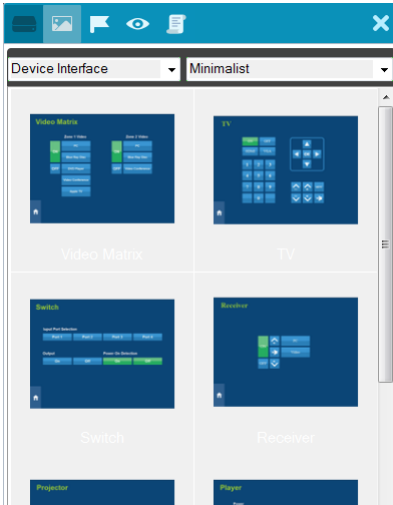

## Library

The **Library** icon on the Project bar offers the following functions. The table below provides an overview of each function.

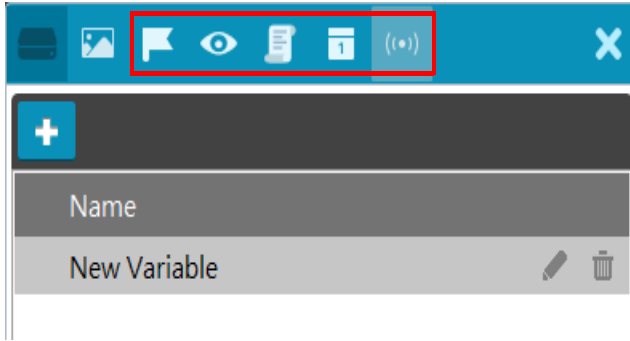

Flag	Flags are created to include parameters when settings are changed to indicate the current status. For details, see <i>Flag</i> , page 120.
Monitor	Monitors allow you to set Conditions for Digital Input (dry contact) and Digital Input (VDC) signals and Flags on a port that will initiate an Action. In addition, you can create <b>Listen to port</b> and <b>Query port</b> monitors which check a device's status to initiate actions. For details, see <i>Monitor</i> , page 122.
Macro	Macros initiate a sequence of actions on one or more hardware devices. For details, see <i>Macro</i> , page 134.
Schedule	Click to create scheduled events. For details, see <i>Scheduled Events</i> , page 136.
Synced Variables	Creates a variable for a device setting (e.g. volume) that is controlled by two or more UI components (e.g. slider bar or buttons) in the viewer. When the device setting is changed through one of the components, its setting is automatically synced and reflected on all components. For details, see <i>Synced Variables</i> , page 137.
<b>+</b>	Opens a pop-up window to create a Flag, Monitor, or Macro.
<b>X</b>	Closes the Library window.



## Flag

*Flags* are created for control buttons to include parameters for when settings are changed or requests are made to change settings on a device. Flags indicate what the status is and what action to take according to the value. Flags are added as actions to *Button Properties* as a **Condition** or **Set Flag** value.

*Conditions* tell a button to initiate associated actions if the flag value is true: “If **Flag** equals **Value**” initiate the action. Actions are associated with a condition so that they only initiate if the flag value is correct. That way an ON command is only sent to a device if the current flag value is OFF.

*Set Flag* changes the flag value when a device setting has changed. So that if a device is OFF and the action turns the device ON, adding a “Set Flag 1 to ON” will change the flag value to ON. Now the flag’s value matches the device status so that actions associated with flag Conditions will initiate accordingly.

Create flags for a device and add them as a *Condition* and *Set Flag* value in the *Action – Button Properties* (see *Button / Slider Bar Action*, page 98).

To create a Flag:

1. Select **Flag** and click **+**.

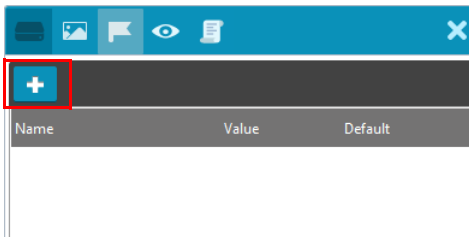

2. The *New Flag* menu appears:

Enter a **Name** and select a radio button to set the flag value:

- ◆ Select **On/Off** and use the drop-down menu to select the *Default Value*.

- ♦ Enter a range (1-100) for the values in the two boxes and use the drop-down menu to select the *Default Value*. Use the drop-down menu to select the format ASCII or HEX.
3. Click **+** to create more flags or double-click a flag to edit it. The flags will appear in the list, as shown below.

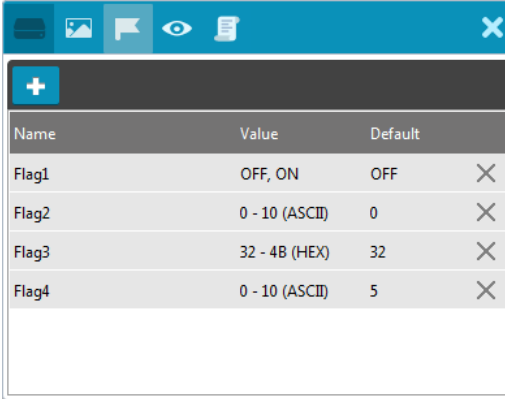

Name	Value	Default	
Flag1	OFF, ON	OFF	✕
Flag2	0 - 10 (ASCII)	0	✕
Flag3	32 - 4B (HEX)	32	✕
Flag4	0 - 10 (ASCII)	5	✕

**Name** – Lists the Flag names which have been created.

**Value** – Lists the flag's values or range of values.

**Default** – Lists the flag's default value.

**X** – Deletes a flag from the list.

4. Select **Condition** or **Set Flag** to add flags as a command in Button Action by selecting a button on a viewer page (see *Button / Slider Bar Action*, page 98).



## Monitor

A *Monitor* allows you to set conditions on a port using **Digital Input (VDC)** and **Digital Input (Dry Contact)** signals, return messages, and Flags. When the condition is met, it will initiate the desired action. Digital Input (VDC) hardware devices provide voltage signals between 1 and 24. Digital Input (Dry Contact) hardware devices provide open and closed circuit signals. Hardware devices with return messages can be monitored using **Listen to port** or **Query port** conditions via text they transmit. These signals provide indicators from sensors or switches of an event. An event can be the temperature, power, dry contact, sensor, switch status, or message from a device. There are two parts to a monitor, the **Condition** and **Action**.

### Condition & Action Overview

A monitor watches a port for a signal or message and when that message or signal is received – the condition is met and an action initiates. Below is an summary of the steps needed to create a monitor.

To create a monitor, follow the steps below.

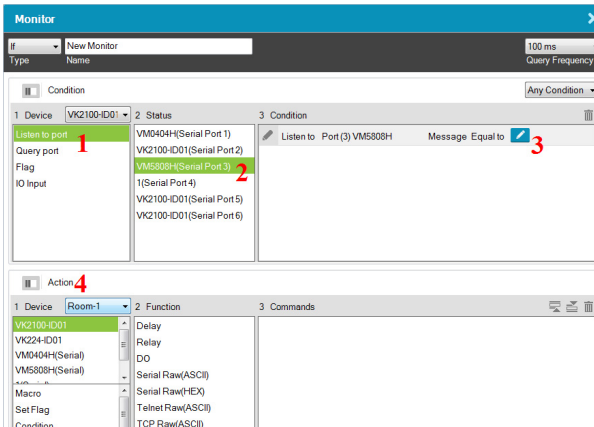

1. Under *Device*, select a monitor type.
2. Under *Status*, add a device port to the Condition List.
3. Double-click the device port in the *Condition List* to configure the condition settings.
4. Add a device action that initiates when the condition is met.





The table below provides a description of the *Monitor* page options.

Type	<p>Use this drop-down menu to select:</p> <p><b>If</b> – select this option for a single condition monitor. “If” the single condition is met, the action initiates.</p> <p><b>Switch</b> – select this option for multiple conditions that use more than one “If” conditions for the monitor. In this type, if one of the conditions is met, the monitor will initiate the action.</p> <p><b>Bypass</b> – select this option to transmit device feedback message to the selected variable actively listening for a message or by receiving a return message from the specified devices.</p>
Name	Enter a unique name for the monitor.
Query Frequency	Use this drop-down menu to select how frequently the monitor checks a device for a signal. Options are: 100 ms - 1 second.

<p>Condition</p>	<p>This section is for adding the condition that will need to be met for the Action to initiate. To add a condition:</p> <ol style="list-style-type: none"> <li>1. Select a monitor under <b>Device</b>.</li> <li>2. Add a device port under <b>Status</b> to the Condition List.</li> <li>3. Configure the condition settings by double-clicking the device port in the <b>Condition</b> List.</li> </ol> <p>Use the <b>Type</b> drop-down menu to select from two condition types: <b>If</b> or <b>Switch</b>. Both are configured similarly, but with Switch you can add multiple comparison conditions called Cases, each of which can initiate the Action.</p>
<p>Action</p>	<p>Use this section to create the commands that will initiate when the monitor's condition is met. See <i>Button / Slider Bar Action</i>, page 98, for details on configuring commands.</p>
	<p>Click to hide or display the Device and Status/Function columns in the Condition and Action lists so that you can see a complete row of Conditions/Commands.</p>
	<p>Click to move an selected command up or down in the Commands list.</p>
	<p>Click to remove an selected command from the Commands list.</p>

## Creating an If Monitor

To create a monitor for a device port with a **Condition** that initiates an **Action**, click **+** from the Library's Monitor tab, and do the following:

1. Select **IF** from the drop-down menu and enter a name for the monitor.
2. Use the drop-down menu to set the **Query Frequency**.
3. Use the **All Conditions / Any Conditions** drop-down menu to select:

These options are only for advanced setups that require multiple events from hardware devices connected to multiple conditions. Most devices only require one signal Status added to the *Condition List* to initiate an *Action*. Most installations will not need to use this option, therefore it can be ignored.

**All Conditions:** Add multiple conditions – all of which must be met for the Action to initiate.

**Any Conditions:** Add multiple conditions – one of which must be met for the Action to initiate.

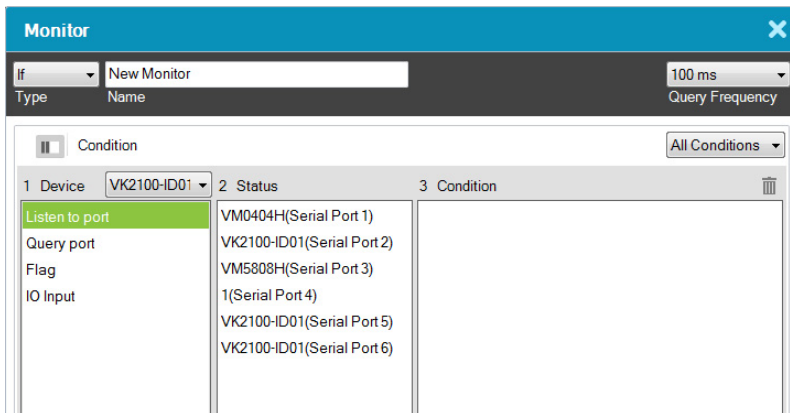

4. Under **Device**, select a **Controller** from the drop-down menu, and then choose one of the following monitor types

**Listen to port** – to create a monitor that actively listens for a message from the device. Under **Status**, double-click a device port to add it to the **Condition** list.

**Query port** – to create a monitor that sends out a command to the device until a feedback message is received from the device.

**Flag** – to create a flag condition for the monitor.

**IO Input** – to create a trigger signal from a device according to the voltage.

- Under **Status**, double-click to add a device port or flag to the *Condition* list. Then double click the device port or flag in the Condition list to configure the condition settings. Each is explained below:

■ **Listen to port / Query port**

(*Query port only*) Click **F(x)** to open the drop-down menu to select a device command to send out; or enter a command string; and then the click *Edit Return Message* icon and do as explained below.

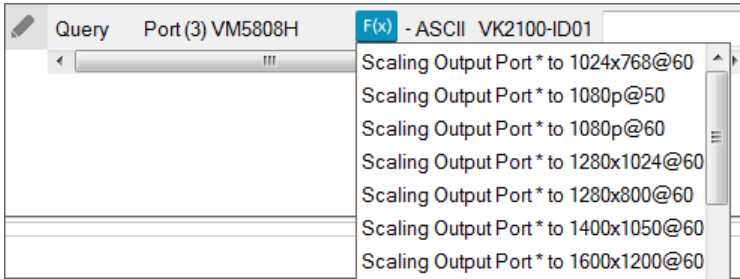

**Edit Return Message**

(*Listen to port / Query port*) Next configure the parameters for the return message from the device. This message must match for the condition to be met. In the **CONDITION** list double-click the command and then click  to open the **Edit Return Message** window:

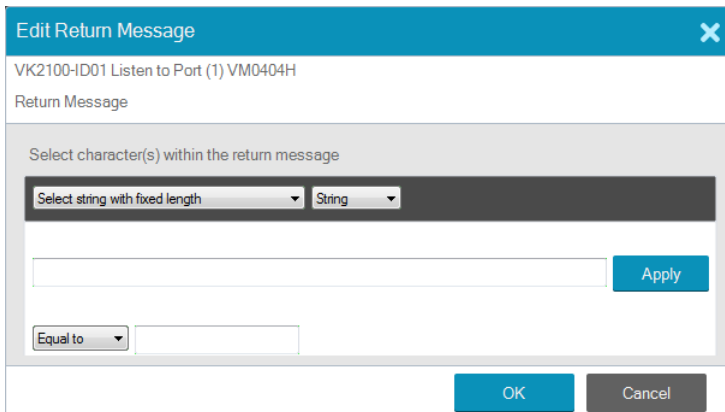

Use the drop-down menu and enter a string of that will represent the characters in a return message from the serial device:

◆ **Select string with fixed length**



Use this to set a string of characters that are set within a fixed parameter. Enter a string of characters and use the **S** to set the start of the string and **E** to set the end and then click **Apply**. The return message will need to fit the fixed string of characters set in the text box next to the *Drop-Down Menu* (see next page) for the monitor to be triggered.

◆ **Select string with a non-fixed length**



Use this to set a string of characters where the parameters are variable. Enter a string of characters and use the **S** to set the start of the string and **E** to set the end and then click **Apply**. The return message will need to fit the fixed string of characters set in the text box next to the *Drop-Down Menu* (see below) for the monitor to be triggered.

◆ **Drop-Down Menu**

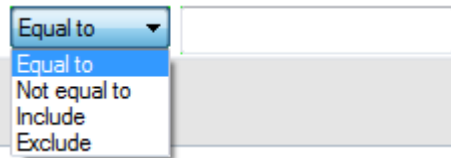

Above, enter characters that the *Select string with fixed length* or *Select string with non-fixed length* string must match and how they must be matched: **Equal to**, **Not equal to**, **Include**, or **Exclude** for the condition to be triggered.

■ **Flag**

Creates a flag condition for the monitor. Use the drop-down menus to set a format (how the flag value must be matched) and the flag value for the condition to be triggered.



## ■ IO Input

Create a trigger signal from a device according to the voltage. Only device with a Digital Input (dry contract) or Digital Input (VDC) port appear in the Status list. Double-click a device in the **Status** list to add it to the Condition list. Double-click the command in the **Condition** list to configure the setting:



The High or Low status tells the Monitor to initiate an Action when the device signal is above or below the threshold setting\* for the port:

### Digital Input (VDC)

- ◆ High - states that when the voltage signal is above the **Upper Threshold** to initiate the Action.
- ◆ Low - states that when the voltage signal is below the **Lower Threshold** to initiate the Action.

### Digital Input (Dry Contact)

According to an open or closed circuit status for the port:

- ◆ Open - states that when the circuit is **Open** to initiate the Action.
- ◆ Closed - states that when the circuit is **Closed** to initiate the Action.

To configure Upper and Lower thresholds, see *Click Advanced to configure the following parameters.*, page 75.

6. (Optional) Use the Operator option to add additional High or Low conditions (see step 4, page 125).
7. Go to the *Action* section at the bottom of the page to select the hardware **Device** and add the **Function** to the **Commands** list, as explain in the steps that follow.

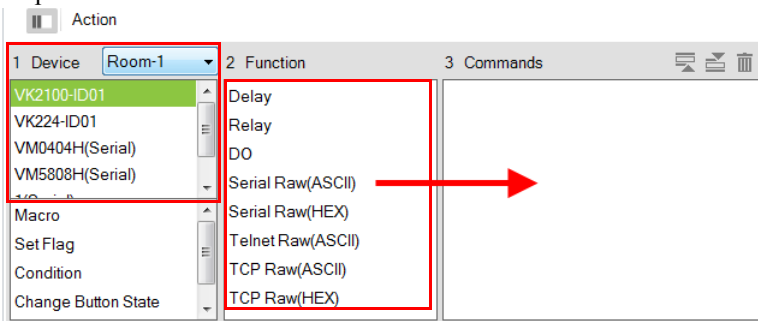

**Note:** For more information on Functions, see *Button / Slider Bar Action*, page 98.

8. First select the hardware under **Devices**.

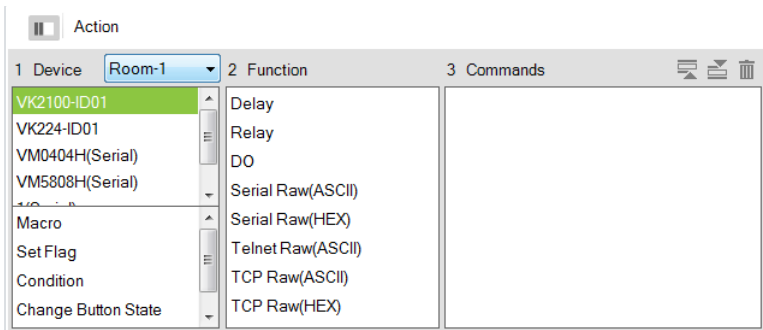

9. Under **Function**, double-click a command to add it to the **Commands** list. This **Command** initiates when the **Condition** is met.

For details on Functions and Commands, see

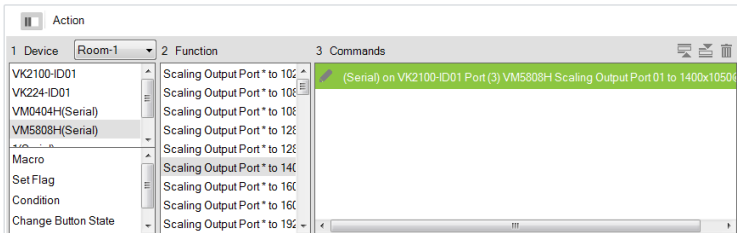

10. You can also add a **Macro**, **Link**, **Set Flag** or Monitor's **Condition**.
11. After adding all the functions to the *Commands* list, the **IF** monitor is complete.

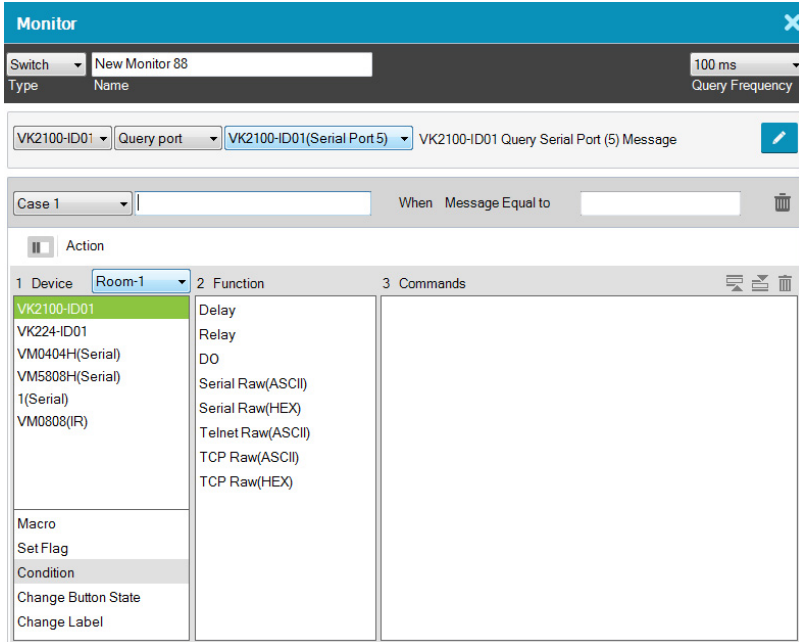

## Creating a Switch Monitor

1. Select **Switch** from the drop-down menu and enter a name for the monitor.
2. Use the drop-down menu to set the **Query Frequency**.
3. Use the options to create multiple condition comparisons, as explained below.



Type	Use the drop-down menu to select: <b>If</b> – select this option for a single condition comparison monitor. <b>Switch</b> – select this option for multi-condition comparisons that use multiple “If” comparisons for the command.
Name	Enter a unique name for the monitor.
Query Frequency	Use this drop-down menu to select how frequently the monitor checks a device for a signal. Options are: 100 ms - 1 second.



Drop-Down Menus	<p>Under the <i>Type</i> drop-down menu are four addition drop-down menus used to configure the Switch Condition:</p> <ul style="list-style-type: none"> <li>◆ <b>Controller</b> – use the first drop-down to menu select the controller for a Switch condition.</li> <li>◆ <b>Listen to port / Query port</b> – use the second drop-down menu to select the condition type for a Switch condition (see step 4, page 125 for details).</li> <li>◆ <b>Serial Device Port</b> – use the third drop-down menu to select a serial device port and configure <i>Edit Return Message</i> (to configure, see <i>Edit Return Message</i>, page 126).</li> <li>◆ <b>Case</b> – use the fourth drop-down menu to add cases by selecting <b>Add More Cases</b> for comparison that need to be met before monitor's condition will initiate. In the left text box enter a name for the Case, in the right text box enter the character string that the return message should match.</li> </ul>
Action	Use this section to create commands for the monitor. See <i>Button / Slider Bar Action</i> , page 98, for details on configuring commands.
	Click this icon to switch to the Action list view so that you can see a complete row of the command's functions. This is a toggle button.
	Closes the Monitor window.

- Go to the *Action* section at the bottom of the page to select the hardware **Device** and add the **Function** to the **Commands** list, as explain in the steps that follow.

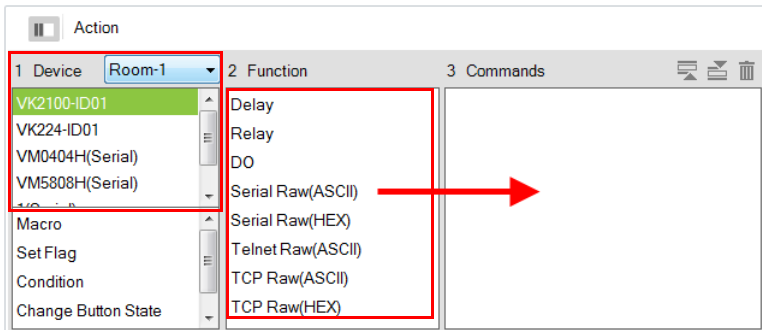

**Note:** For more information on Functions, see *Button / Slider Bar Action*, page 98.

5. First select the hardware under **Devices**.

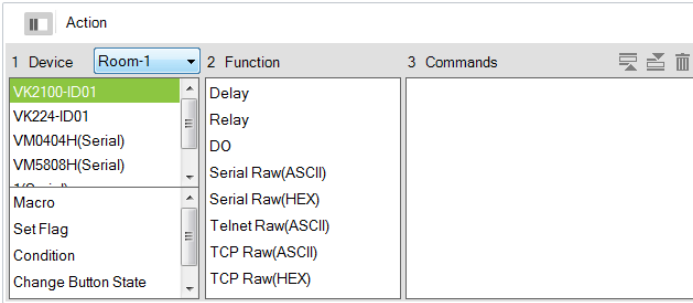

6. Under **Function**, double-click a command to add it to the **Commands** list. This is the **Command** that initiates when the **Condition** is met. For details on what each function does, see *Adding Commands*, page 100.

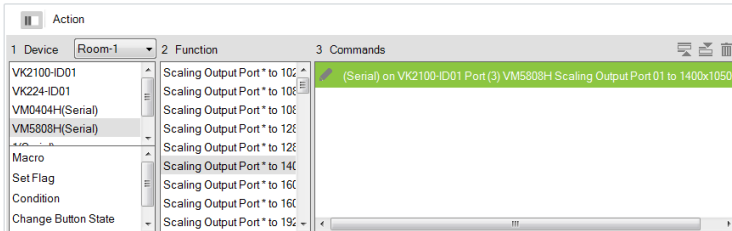

7. You can also add a **Macro**, **Link**, **Set Flag** or Monitor's **Condition**.

8. After adding all the functions to the *Commands* list, the **Switch** monitor is complete.

## Creating a Bypass Monitor

Follow the steps below to create a bypass monitor.

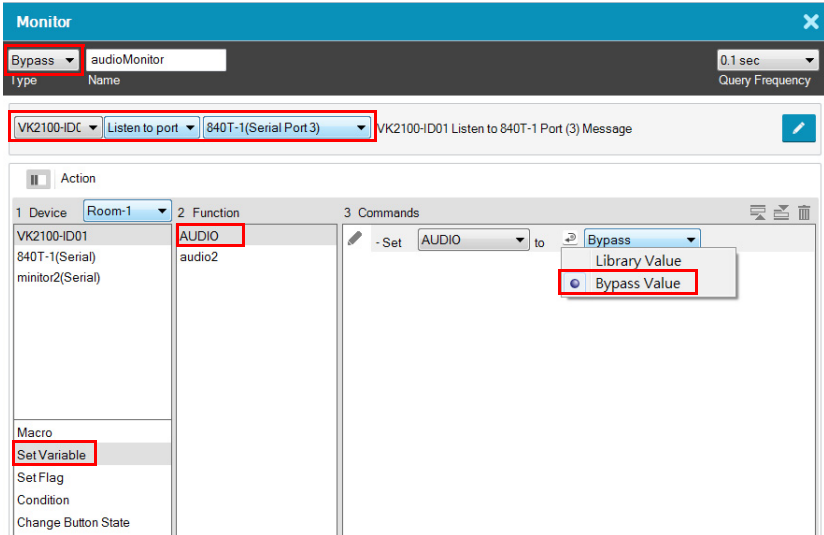

1. Select **Bypass** from the drop-down menu and enter a name for the monitor.
2. Configure the following settings.
  - ♦ **Query frequency:** sets how frequently the monitor checks the device for a signal. Valid values range from 100 ms to 1 second.
  - ♦ In the second drop-down list, select one of the following:
    - ♦ **Listen to port:** actively listens for a message from the specified device.
    - ♦ **Query port:** when a setting is changed on the specified device, the device sends a feedback message to the Control Box, informing the latest setting.
  - ♦ In the last drop-down list, select the port or the device to be monitored.
3. Configure the actions.
  - a) Select **Set Variable**.
  - b) Double-click the variable you wish to update when Control Box detects a change for the specified device setting.
  - c) For a variable, double-click the command and select **Bypass**.





## Macro

Macros allow you to create a button that will initiate a sequence of actions across the same or different hardware devices. This saves time by allowing multiple devices to initiate actions all at once from one button. For example, you can create a macro to start a video presentation by adding functions to: dim lights, power on source, power on display, lower screen and play source. You can also add time delays between actions in a macro.

When you click **+** from the Library's **Macro** tab, the window opens:

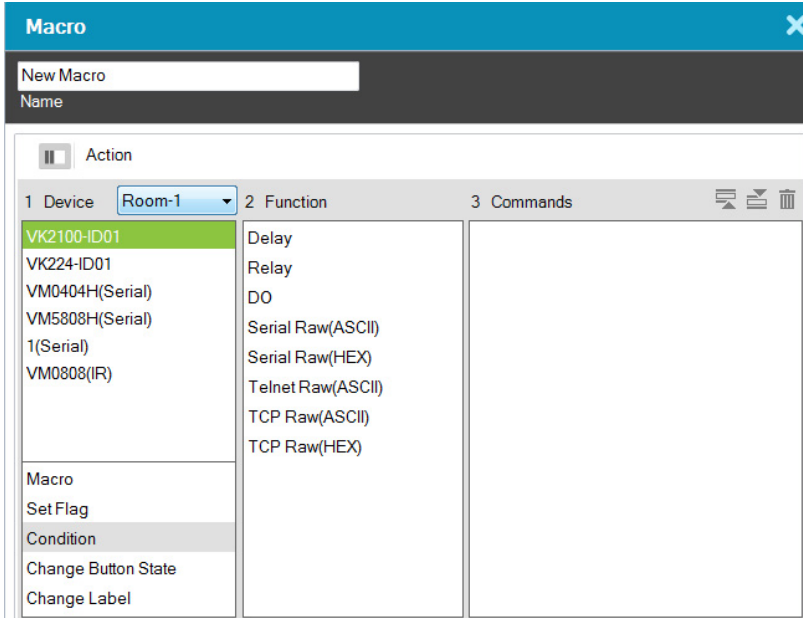

To create a macro:

1. Select **Macro** and click **+**.
2. Enter a **Name** and select a **Viewer** from the drop-down menu, then click **OK**.
3. Go to the *Actions* section at the bottom of the page to select hardware under **Device** and add the **Function** to the **Commands** list:

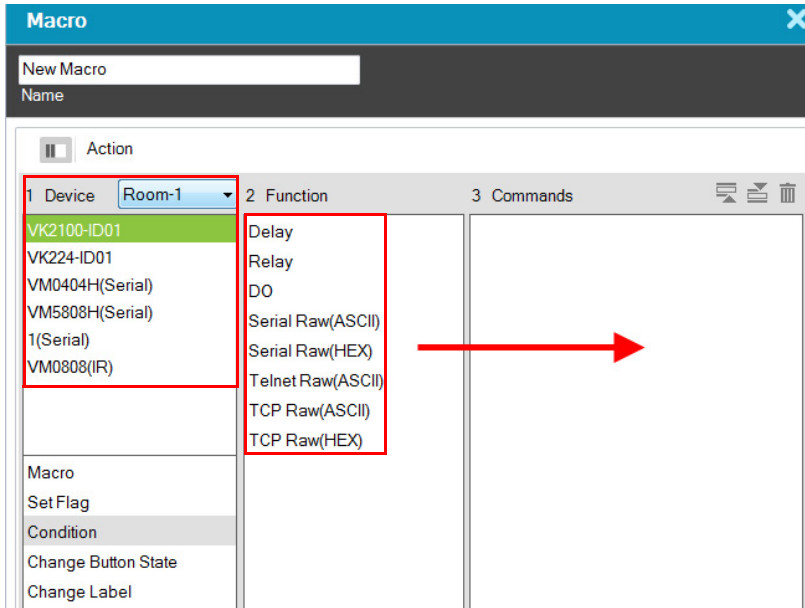

**Note:** For more information on adding Functions, see *Button / Slider Bar Action*, page 98.

4. After adding all the functions to the *Commands* list, the macro is complete.
5. In *Create Viewer & Design*, create a button and add a macro to the *Button Action* properties (see page 98) by selecting **Macro** under *Devices* (see *Adding Commands*, page 100 for details).

## Scheduled Events

By setting up a scheduled event, you can have a connected hardware device, such as ATEN Control Boxes, perform one or a series of actions on a recurring schedule.

To create a new event, follow the steps below.

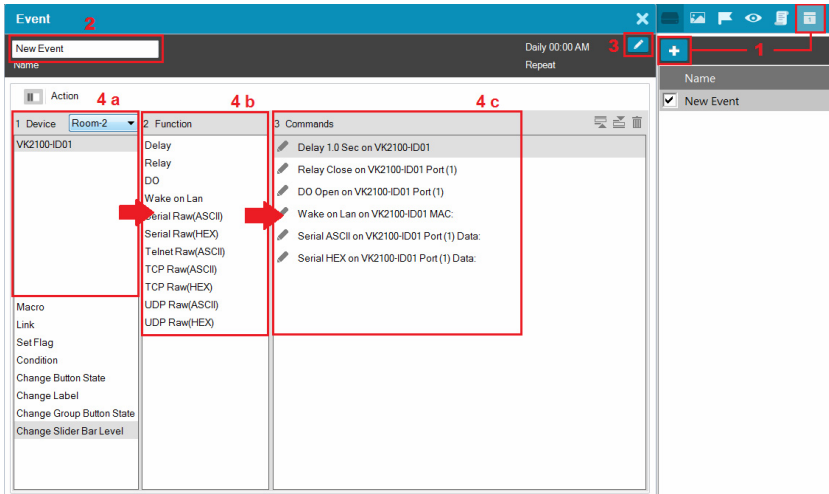

1. Click and then click .
2. Name the event.
3. Click to specify a recurring schedule for the event.
4. Configure event actions.
  - a) In the Device column, select a device.
  - b) In the Function column, double-click the desired functions. The corresponding commands appear in the Commands column. For details on what each function does, see *Adding Commands*, page 100.
  - c) In the Commands column, double-click each command to configure the settings.
5. Optionally add system functions. For detailed information, see *Advanced Options*, page 104.
6. These commands will initiate in the listed order. To change the order of the commands, click .

## **Synced Variables**



This feature is useful when you have two or more UI components controlling a single device setting. Take the example of controlling a speaker volume on a Viewer. You may have a slider bar, a button for maximum volume, and another button for minimum volume on your Viewer. When you tap the maximum volume button, you would like the following actions to happen:

- ◆ The maximum volume button shows a toggle-on status
- ◆ The minimum volume button synchronized with this setting and shows a toggle-off status
- ◆ The slider bar synchronizes with this setting and moves to its highest volume

To achieve this automatic synchronization and status change, you can create a synced variable. A synced variable is a value holder that stores a single device setting (e.g. speaker volume) and can be assigned to two or more UI components (e.g. a slider button, a maximum volume button, and a minimum volume button). This way, when a device setting is changed via one of the UI components, the new setting will be loaded into this variable and then reflected by the UI components in the Viewer.

### **For Devices that Return Feedback Messages**

Follow the steps below to set up a synced variable if the variable (device setting) is for a device that returns feedback messages to the Control Box.

1. Create a synced variable for the device setting (e.g. speaker volume).
  - a) In the **Design** tab, click **Library**.
  - b) Click the **Synced Variables**  icon and then click .
  - c) Configure the following settings.
    - ◆ **Name:** Type a name for the variable.
    - ◆ **String format:** Select the string format for the target device.
    - ◆ **Setting range:** Type the range for setting.
    - ◆ **Default value:** Type a default for the setting.

Your settings may look like this:

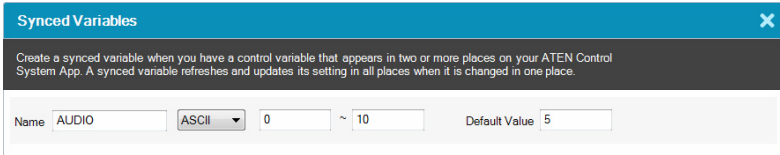

2. Configure control components for the Viewer. For details, see *Design*, page 82.

a) In the **Design** tab, add control components to your Viewer.

**Note:** The Synced Variable function is only applicable to toggle buttons, basic-mode slider bars, and radio groups of normal buttons. Configure the **Mode** setting before you proceed.

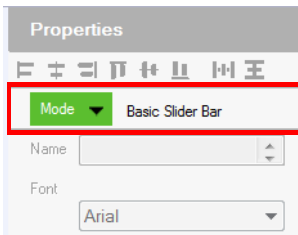

b) For a slider bar component, click it in the Viewer page and configure the **Value** settings in Properties.

c) In Properties, click **Set Sync Condition** and select the variable you created using the drop-down list.

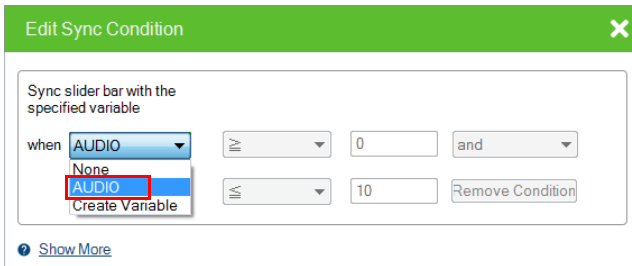

3. Create a Monitor to set up the conditions for which the device sends its latest setting to the variable. For detailed steps, see *Creating a Bypass Monitor*, page 133.





## For Devices that Do Not Return Feedback Messages

Follow the steps below to set up a synced variable if the variable (device setting) is for a device that *does not* return feedback messages to the Control Box.

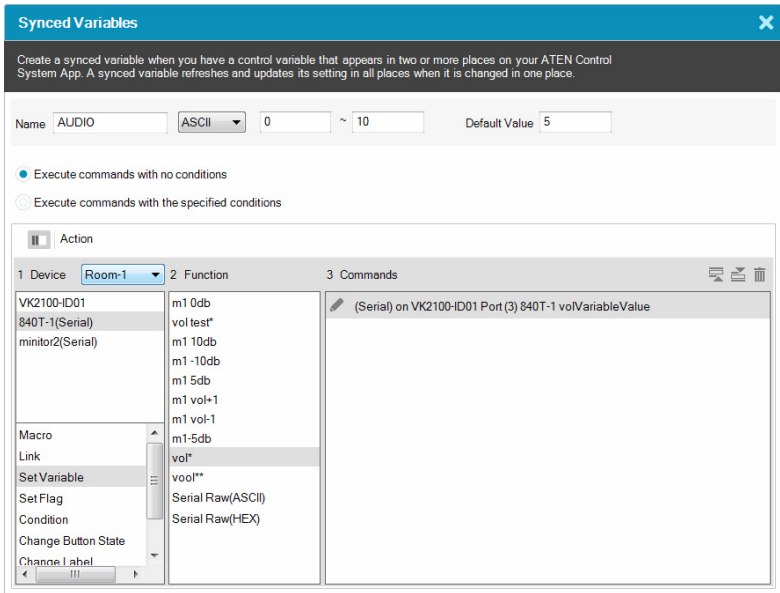
1. Create a synced variable for the device setting (e.g. speaker volume).



- a) In the **Design** tab, click **Library**.
- b) Click the **Synced Variables**  icon and then click .
- c) Configure the following settings.
  - ◆ **Name:** Type a name for the variable.
  - ◆ **String format:** Select the string format for the target device.
  - ◆ **Setting range:** Type the range for setting.
  - ◆ **Default value:** Type a default for the setting.
  - ◆ Select a command execution type.
    - ◆ **Execute commands with no conditions:** Execute the command (action) when the specified variable changes.
    - ◆ **Execute commands with the specified conditions:** Execute the corresponding command (action) when the variable matches.

2. Configure control components for the Viewer.

- a) Add a control component to the Viewer. For details, see *Design*, page 82.  
**Note:** Make sure to configure the component mode before proceeding to the next step.
- b) For a slider bar component, click it and configure value settings in Properties.
- c) Click **Set Variable**, and then double-click the variable you created in step 1.
- d) In Properties, click **Set Sync Condition** and select the variable you created using the drop-down list.

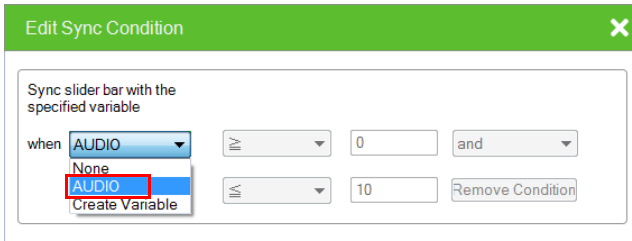

3. Repeat steps (a) to (d) with each of the components. If you select **Execute commands with the specified conditions**, follow the steps below to add commands.

- a) Refer to step 4 to first configure the UI components.
- b) Click Library, click the **Synched Variables**  icon, and then click the variable you created in step 1.
- c) Click the drop-down list below the Execute commands with the specified conditions option and select a condition.
- d) Add an action (command) when this condition is met. Select a device, double-click a desired function, and then double-click the command to configure the setting.

In the case of speaker volume, when the volume changes to 0 (i.e. the condition is **Variable = 0**), the action will be “to change the speaker volume to 0”, as illustrated below.

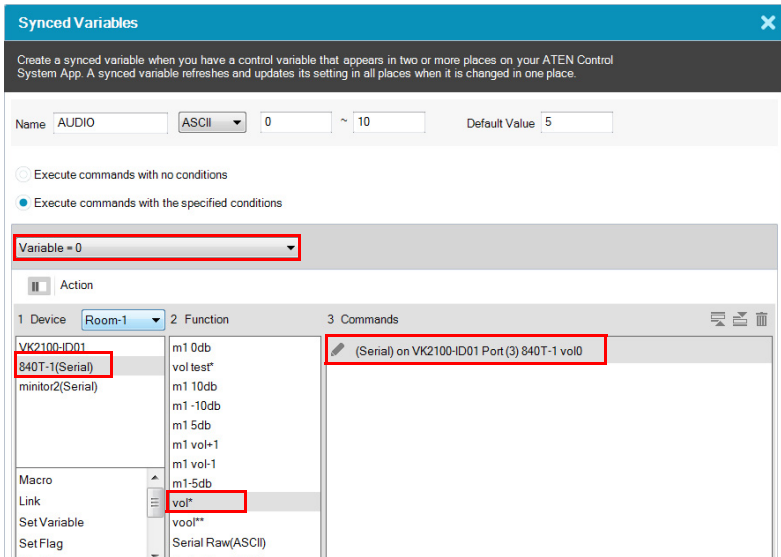

- e) Repeat steps 2(c) and 2(d) to add one or more actions to each condition.
4. If you select **Execute commands with no conditions**, follow the steps below to add commands.
- In the **Device** list, click to select the device. In this example, the mixer, **840T-1(Serial)**, is selected.
  - Double-click the action (command) and change the value type to **Variable Value**.

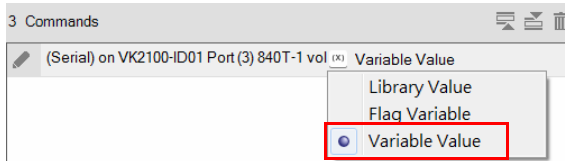

## Upload

The *Upload* page allows you to upload viewers or back up project to Control Boxes.

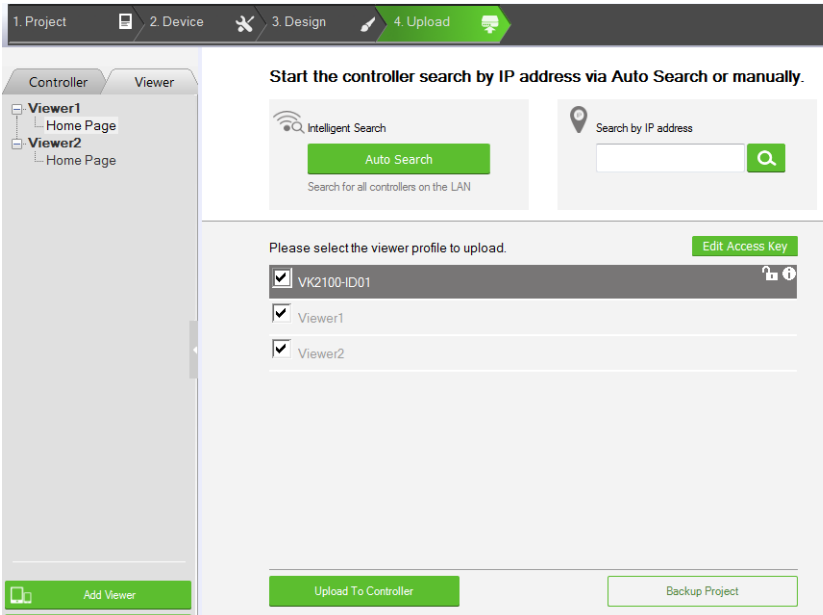





### **Backing Up the Project to Control Boxes**

To back up the project file:

1. Browse for the Control Box to upload the project file.
  - ◆ Auto Search: Browses for Control Boxes on the same LAN with the Configurator.
  - ◆ Search by IP address: Use this function to browse for Control Boxes that are on different LANs to the Configurator.
2. Click **Back Up Project**.

**Note:** To download a previously backed up project file, go to File > Restore Project from Controller.

## **Uploading Viewers to Control Boxes**

1. Browse for the ATEN Control Box to upload the configured viewers.
  - ◆ Auto Search: Browses for Control Boxes on the same LAN with the Configurator.
  - ◆ Search by IP address: Use this function to browse for Control Boxes that are on different LANs to the Configurator.
2. Select viewers.
3. Optionally click on the following to configure password authentication settings.
  - ◆ **Edit Access Key**: Click to change the access key required to upload viewers to the Control Box and download viewers from a mobile device.
  - ◆  : An access key is required to upload viewers to the Control Box and download viewers from a mobile device.
  - ◆  : An access key is *not* required to upload viewers to the Control Box and download viewers from a mobile device.
  - ◆   : The access key has been changed on the Control Box's web interface (Dashboard). To change the lock status, click on the icon and type the new access key to proceed.
4. Click **Upload to Controller**.

## **Viewing Control Box Information**

Click  to view the Control Box's information.

- ◆ **IP Address:** Displays the IP address.
- ◆ **MAC Address:** Displays the MAC address.
- ◆ **License:** Displays the number of licenses available and in use.
  - ◆ **Select License:** Allows you to load a new license file.
  - ◆ **Reset License:** Resets all license(s) in use by mobile devices. This will disconnect all mobile device connections to the Control Box.
- ◆ **Firmware Version:** Displays the firmware version.
  - ◆ **Select Firmware:** Allows you to load a firmware upgrade file to update the firmware.
- ◆ **Capacity:** Displays the amount of space available for uploading viewers.
- ◆ **Viewers:** Lists the viewers currently stored on the Control Box.
  - ◆ **Remove Viewer:** Click the trash can icon to remove the viewer stored on the Control Box.
- ◆ **Project:** Lists the project file currently stored in the Control Box.

# Chapter 5

## ATEN Database Generator

### Overview

The *ATEN Database Generator* lets you add, edit, and manage hardware devices for **My Device Library**. To open the Database Generator from the ATEN Configurator, use the menu bar to select *Tools* → *Database Generator*. The first time the application is opened, a window appears with four options:

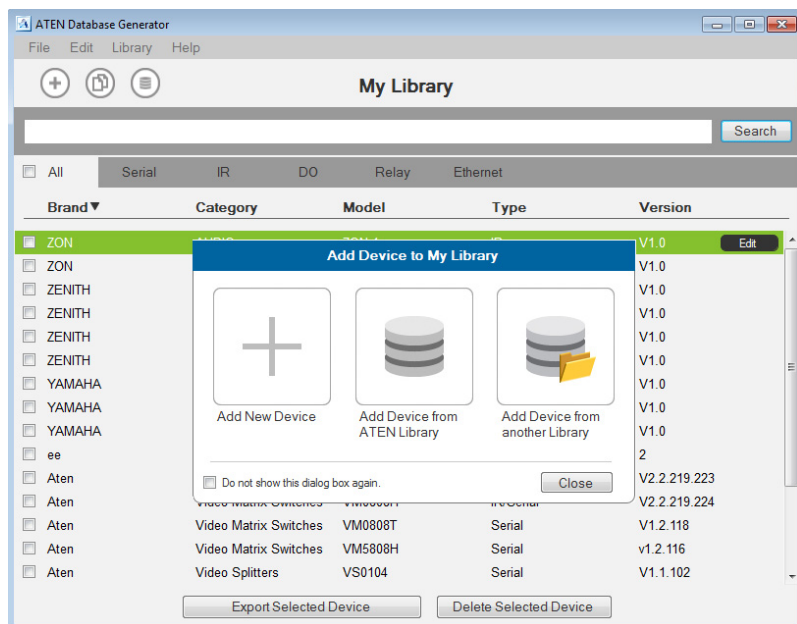

Add New Device	Configure a custom hardware device to add to My Library.
Add Device from ATEN Library	Add devices from the ATEN Device Library to My Library.
Add Device from another Library	Add devices from a database file (*.vkd) to My Library.
Check Box	Click <i>Do not show this dialog again</i> to prevent the dialog from appearing when the Database Generator is opened. Use the Preferences menu option to bring the dialog window back.
Close	Click the <b>Close</b> button to exit the dialog window.

## My Library

*My Library* allows you to create custom hardware devices which can be selected to configure ports on the VK1100 and VK2100. **My Library** lists all the hardware devices that you have created, added and edited using the Database Generator. You can create new hardware devices and/or add existing devices from the ATEN Library (page 163). These devices can then be selected from **My Device Library** for use.

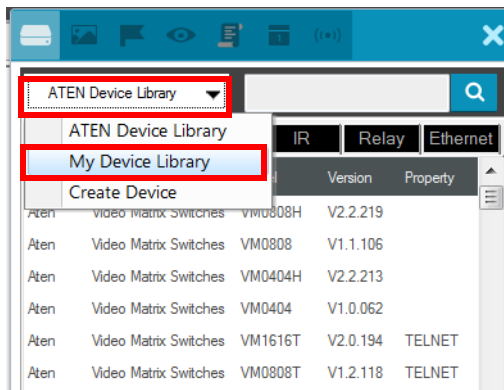
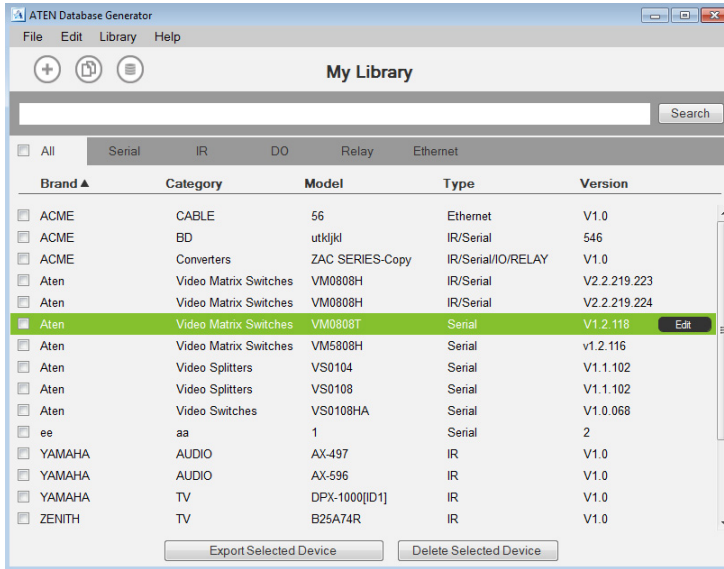



Menu	Description
File	<p>The <i>File</i> menu provides options to:</p> <ul style="list-style-type: none"> <li>◆ <b>Add New Device:</b> Configure a custom hardware device to add to Device Library.</li> <li>◆ <b>Add Device from ATEN Library:</b> Add devices from the ATEN Device Library to My Library.</li> <li>◆ <b>Add Device from another Library:</b> Add devices from a database file (*.vkd) to My Library.</li> <li>◆ <b>Export My Library:</b> Saves My Library as a database file (*.vkd) that can be imported later.</li> <li>◆ <b>Export Selected Device:</b> Saves the selected device(s) as a database file (*.vkd) that can be imported later.</li> <li>◆ <b>Controller Connection:</b> Searches for a Control Box to test the connection or run the learning mode for the IR port.</li> <li>◆ <b>Quit:</b> Exits the program.</li> </ul>
Edit	<p>The <i>Edit</i> menu provides options to:</p> <ul style="list-style-type: none"> <li>◆ <b>Delete:</b> Deletes the selected devices from the database.</li> <li>◆ <b>Duplicate:</b> Makes a copy of the selected device(s) and adds them to the library with the extension "-Copy"</li> <li>◆ <b>Preferences:</b> Provides options to: <ul style="list-style-type: none"> <li>◆ Set the <i>Language</i></li> <li>◆ <i>Show Add Device dialog on startup</i></li> <li>◆ <i>Show IR Learning tips</i></li> <li>◆ Set the <i>IR Learning Timeout</i> - how long to attempt a connection to an IR device before IR learning stops.</li> </ul> </li> </ul>
Library	<p>Provides a list of the Libraries that you can open to select devices from and edit or add to My Library. The libraries that are listed here appear when you select a database using <i>Add Device from another Library</i>.</p>
Help	<p>The Help menu provides two options:</p> <ul style="list-style-type: none"> <li>◆ <b>Update ATEN Library:</b> Allows you to browse for a database file (*.vdk) to import devices into the ATEN library.</li> <li>◆ <b>About:</b> Provides support and software version information.</li> </ul>

## Managing My Library

When devices are added to My Library, they appear listed in the main window. New devices can be added by creating a new device, copying an existing device or by selecting a device from the ATEN Library. Use the check boxes to select individual devices or **All** to select the entire list.

The screenshot shows the 'My Library' window with a search bar and filter tabs (All, Serial, IR, DO, Relay, Ethernet). Below the filters is a table with the following data:

Brand ▲	Category	Model	Type	Version	
<input checked="" type="checkbox"/> ACME	CABLE	56	Ethernet	V1.0	<b>Edit</b>
<input type="checkbox"/> ACME	Converters	ZAC SERIES-Copy	IR/Serial/O/RELAY	V1.0	
<input type="checkbox"/> Aten	Video Matrix Switches	VM0808H	IR/Serial	V2.2.219.223	
<input type="checkbox"/> Aten	Video Matrix Switches	VM0808H	IR/Serial	V2.2.219.224	
<input type="checkbox"/> Aten	Video Matrix Switches	VM0808T	Serial	V1.2.118	
<input type="checkbox"/> Aten	Video Matrix Switches	VM5808H	Serial	v1.2.116	
<input type="checkbox"/> Aten	Video Splitters	VS0104	Serial	V1.1.102	
<input type="checkbox"/> Aten	Video Splitters	VS0108	Serial	V1.1.102	
<input type="checkbox"/> Aten	Video Switches	VS0108HA	Serial	V1.0.068	
<input type="checkbox"/> ee	aa	1	Serial	2	
<input type="checkbox"/> YAMAHA	AUDIO	AX-497	IR	V1.0	
<input type="checkbox"/> YAMAHA	AUDIO	AX-596	IR	V1.0	
<input type="checkbox"/> YAMAHA	TV	DPX-1000[0D1]	IR	V1.0	
<input type="checkbox"/> ZENITH	TV	B25A74R	IR	V1.0	
<input type="checkbox"/> ZENITH	TV	B50M90W	IR	V1.0	
<input type="checkbox"/> ZENITH	TV	P42W22	IR	V1.0	

Buttons at the bottom: **Export Selected Device** and **Delete Selected Device**.



Click to add a new custom device to the database.



Select a device and click this icon to create a duplicate.



Click to add and edit a device from the ATEN Library.

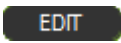

Select a device and click **Edit** to change the settings.

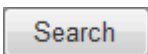

Key in word strings then click **Search** to find a device.

- ◆ Click **All**, **Serial**, **IR**, **DO**, **Relay** or **Ethernet** to filter the list by type.
- ◆ Click **Brand**, **Category**, **Model**, **Type** or **Version** to sort the devices.
- ◆ Click **Export Selected Device** to save the selected devices.
- ◆ Click **Delete Selected Devices** to remove the selected devices.

## Edit / Add New Device

To edit or add a device to My Library, do the following:

1. From the menu select **File** → **Add New Device**, or select a device from My Library and click **Edit**.
2. Under **General**, use the drop-down menus or type in the *Brand Name*, *Category*, *Model* and *Version*.

**Note:** The *Category* determines what buttons are auto generated when a viewer page is created for the device.

3. Use the **History** button to open the *Version History* editor and make notes about the updates being made to the device configuration. You can create and use different versions of the same device and track the changes. The version history can be viewed and different versions selected from the ATEN Configurator, under device **Properties**.
4. Check the hardware type and configure the device:

### Serial

Function	Command	Feedback	Action
Turn on Output Port*	sw o[01-04] on\r\n		Retrieve Send



Click to add an Action.



Click to create a duplicate of the Action.



Click to delete the selected action.



Click to enter a string within () which allows the text to be edited from the VK6000 in the *Button Action - Commands* list (see page 100).



Click to add a drop menu into a Command string, then enter the number sequence in the brackets []. The **Function** name must include an Astrix (\*) for each drop menu in the Command string. The drop-down menu will appear where the (\*) is entered in the Function name.



Click to add an *Enter* into the Command string.



Click to open a list of commands to add into the Command string.

- ◆ **Settings** – Use the drop-down menus to set the: *Baud Rate, Data Bit, Stop Bit, Parity, Flow Control* and *Mode* settings.
  - ◆ **Advanced** – Click to use the *Delay Interval* drop-down menu to set a timed delay for each command before it is sent to the device.
- ◆ **Function List** – Use this section to configure the device functions by adding actions to the list.

**String Format** – Use the buttons to select *HEX* or *ASCII*.

**Function** – Lists the actions created for a device. A Function name must include an Astrix (\*) if you are adding a drop menu to the Command string. Double click to edit the function name.

**Command** – Shows the command string created for the action. Double-click to edit the string.

**Feedback** – Provides the Return Messages when the **Retrieve** and **Send** buttons are used to test the command strings.

Click **Retrieve**. The Select Controller window appears.

Click to select a controller from the list. Use the **Refresh** button to refresh the list. To browse for controllers in the LAN, click the **Intelligent Search** button or type the IP address of the controller

**Port** – Selects a serial port.

**Receive message for** – Specifies the maximum allowed time that the device uses for receiving messages from the controller.

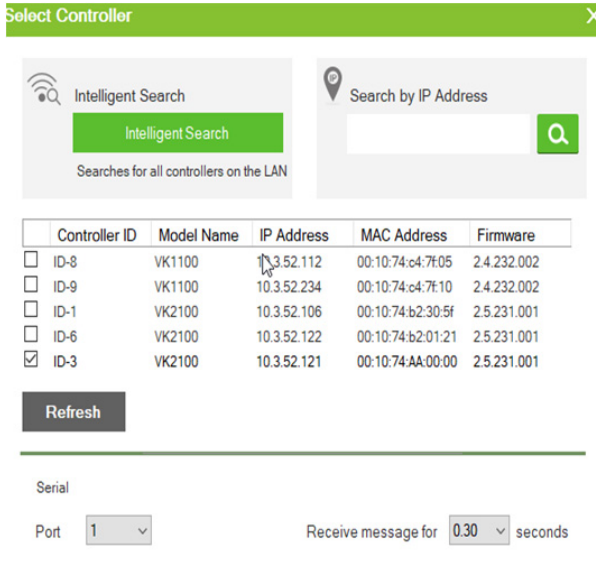

	Controller ID	Model Name	IP Address	MAC Address	Firmware
<input type="checkbox"/>	ID-8	VK1100	10.3.52.112	00:10:74:c4:7f:05	2.4.232.002
<input type="checkbox"/>	ID-9	VK1100	10.3.52.234	00:10:74:c4:7f:10	2.4.232.002
<input type="checkbox"/>	ID-1	VK2100	10.3.52.106	00:10:74:b2:30:5f	2.5.231.001
<input type="checkbox"/>	ID-6	VK2100	10.3.52.122	00:10:74:b2:01:21	2.5.231.001
<input checked="" type="checkbox"/>	ID-3	VK2100	10.3.52.121	00:10:74:AA:00:00	2.5.231.001

Serial

Port

Receive message for  seconds

**Send** – To use this button refer to the instructions on page 161.

## Text Command Tools

The following formats allow you to enter command strings with text that provide special features. These formats work in Serial and Ethernet commands.

- ♦ **()** entering text in **()** allows the command to be edited in the VK6000.

**Example:** *(A1 A9) (A8 B6)* – this command string will provide two editable text boxes from the VK6000 in the *Button Action - Commands* list which allow you to change the command string:

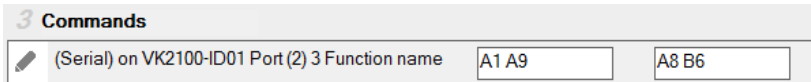

3 Commands

(Serial) on VK2100-ID01 Port (2) 3 Function name

- ♦ **=** using the equals sign before a text command allows you to type in words which will show up in a drop-down menu to describe the command, rather than show the text command itself.

**Example:** *[Power On=0A,Power Off=0B,Standby Mode=0C]* – this command string will provide a drop-down menu with three choices using

the text before the equal signs to describe each command – from the VK6000 in the *Button Action - Commands* list:

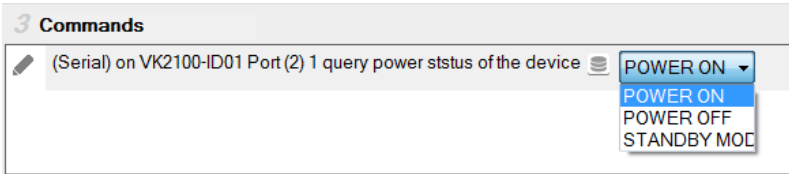

- ◆ “““ quotation marks allow three symbols (, = @) to be added to a command that uses the equal sign as described in the example above. Three symbols not allowed within the quotation marks include (“” () []). Quotation marks can be used to the left of = in a **HEX** command; on either side of = in an **ASCII** command; and anywhere in an **Ethernet** command.

**HEX Example:** ["Power=On"=0A,"POWER=OFF"=0B]

**ASCII Example:** "Power=On"=0A,POWER OFF="0B=AC"

In the HEX example, “**Power=On**” allows the equal sign to be inserted before **=0A**. If the quotes are removed, the command **Power=On=0A** would fail as an *Invalid String*.

## ■ IR

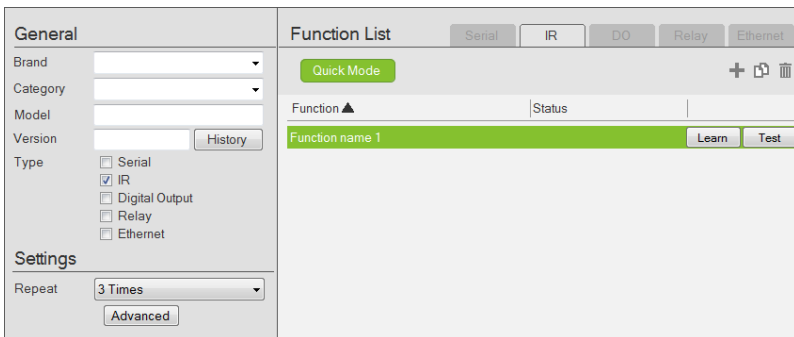

 Click to add an Action.

 Click to create a duplicate of the Action

 Click to delete the selected action.

- ◆ **Settings** – Use the drop-down menu to set the **Repeat** setting (number of times a signal is sent): *1 Time, 2 Times* or *3 Times (Default)*.
  - ◆ **Advanced** – Click to use the *Delay Interval* drop-down menu to set a timed delay for each command before it is sent to the device.
- ◆ **Function List** – Use this section to configure the IR functions by adding actions to the list.

**Quick Mode** – Click to run Learning Mode for all IR actions in the Function List. When the Quick Mode window opens, click **Start**, a pop-up window appears to select a controller. Check a box to select a controller and click Select. Click **Start** a second time to run Quick Mode using the *Learn* instructions below.

**Function** – Lists the actions created for a device. Double-click to edit the Function the name.

**Status** – Reports the status (**Tested, Failed, Learned**) of the Learn and Test buttons.

**Learn** – Use to transfer commands from an IR remote to the Control Box.

Click **Learn**. The Select Controller window appears.

Click to select a controller from the list. Use the **Refresh** button to refresh the list. To browse for controllers in the LAN, click the **Intelligent Search** button or type the IP address of the controller.

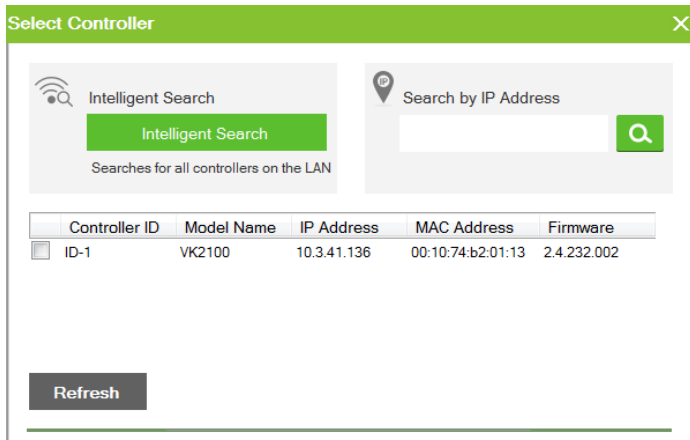

Click **Learn** a second time to start learning mode. When the IR Learn LED flashes green, point the IR remote at the Control Box's front panel IR Receiver and push a button on the remote. Press the

button on the remote just as you would when using it with the hardware device. If the device responds to a *long hold* or *quick tap* of the remote's button then you must press the button in the same manor (long hold or quick tap) when it using for Learning mode. The Control Box will beep and the Learn LED will light solid (then turn off) when IR learning is successful. The LED also turns off if Learning mode times out.

**Test** – Use to test if commands are sent successfully to the Control Box and hardware device.

Click **Test**, a pop-up window appears to select a controller and the IR port. Check a box to choose a controller and use the drop-down menu to select the IR port and then click **Select**.

Click **Test** a second time to test if the IR data transmits successfully to the Control Box. Check the hardware device to confirm that it responded appropriately.

The **Status** column reports the Learn and Test results.

## ■ Digital Output



Click to add an Action.



Click to create a duplicate of the Action



Click to delete the selected Action.

- ◆ **Advanced** – Click to use the *Delay Interval* drop-down menu to set a timed delay for each command before it is sent to the device.
- ◆ **Function List** – Use this section to configure the Digital Output device functions by adding actions to the list.



**Function** – Lists the actions created for a device. Double-click to edit the Function name.

**Command** – Shows the command selected for the action. Click the drop-down menu to select an action (Open, Close, Toggle, Pulse).

## ■ Relay



Click to add an Action.



Click to create a duplicate of the Action



Click to delete the selected Action.

- ◆ **Advanced** – Click to use the *Delay Interval* drop-down menu to set a timed delay for each command before it is sent to the device.
- ◆ **Function List** – Use this section to configure the Relay device functions by adding actions to the list.

**Function** – Lists the actions created for a device. Double-click to edit the Function name.

**Command** – Shows the command selected for the action. Click the drop-down menu to select an action (Open, Close, Toggle, Pulse).

## ■ Ethernet

<p><b>General</b></p> <p>Brand <input type="text"/></p> <p>Category <input type="text"/></p> <p>Model <input type="text"/></p> <p>Version <input type="text"/> <input type="button" value="History"/></p> <p>Type</p> <p><input type="checkbox"/> Serial</p> <p><input type="checkbox"/> IR</p> <p><input type="checkbox"/> Digital Output</p> <p><input type="checkbox"/> Relay</p> <p><input checked="" type="checkbox"/> Ethernet</p> <p><b>Settings</b></p> <p>Protocol <input type="text" value="TELNET"/></p> <p>Port <input type="text" value="23"/></p>	<p><b>Function List</b>    Serial    IR    DO    Relay    Ethernet</p> <p style="text-align: right;">+               </p> <table border="1"> <thead> <tr> <th>Function ▲</th> <th>Command</th> <th>Feedback</th> </tr> </thead> <tbody> <tr style="background-color: #c8e6c9;"> <td>Function name 1</td> <td>Retrieve</td> <td>Send</td> </tr> </tbody> </table>	Function ▲	Command	Feedback	Function name 1	Retrieve	Send
Function ▲	Command	Feedback					
Function name 1	Retrieve	Send					



Click to add an Action.



Click to create a duplicate of the Action.



Click to delete the selected action.



Click to enter a string within ( ) which allows the text to be edited from the VK6000 in the *Button Action - Commands* list (see page 100).



Click to add a drop menu into a Command string, then enter the number sequence in the brackets []. The **Function** name must include an Astrix (\*) for each drop menu in the Command string.



Click to add an *Enter* into the Command string.



Click to open a list of commands to add into the Command string.

For special command string tools, see *Text Command Tools*, page 151.

### ◆ Settings

- ◆ **Protocol** – Click the drop-down list to select a protocol for the device
- ◆ **Port** – Type the port number for the device.
- ◆ **Advanced** – Click this button to access advanced settings.

## Advanced Settings



Command Interval  seconds

Delay Time After Login  seconds (0.0-180.0)

**Send Command after successful connection**

1st Command

2nd Command

Automatically reconnect to the device if no return message is received

Use Default

Save

No

Command Interval	Use the <i>Command Interval</i> drop-down menu to set a time delay for each command before they are sent to the device.
Delay Time after Login	Sets a delay (to allow a connection to be established) before the First and Second Commands are sent to the device.
Send command after connection	Enter a <i>First</i> and <i>Second Command</i> to send to the device after a successful connection has been established.
Automatically reconnect if no return message is received	Check this box if you want to continue reconnection attempts when no return message is received from the device.
Use Default	Click this button to reset back to the default settings.

- ◆ **Function List** – Use this section to configure the device functions by adding actions to the list.
  - ◆ **String Format** – Use the buttons to select *HEX* or *ASCII*. (TCP only)
  - ◆ **Function** – Lists the actions created for a device. A Function name must include an Astrix (\*) for each drop menu you add to the Command string. Double-click to edit the function name. The drop-down menu will appear where the (\*) is entered in the Function name
  - ◆ **Command** – Shows the command string created for the action.
    - ◆ To edit a command for a Telnet, PJLINK, ONVIF, or TCP compliant device, double-click the **Command** field (green area in the interface).
    - ◆ To edit a command for an HTTP or HTTPS compliant device, click the **Edit** button. The Edit HTTP Command window appears.

- ◆ **Feedback** – Provides the Return Messages when the **Retrieve** and **Send** buttons are used to test the command strings (Telnet, PJLink, TCP, UDP only).
  - ◆ **Retrieve** – Click this button to test the Command string and receive return messages from a device. Click **Retrieve**, a pop-up window appears to select a controller. Check a box to choose a

controller and enter the IP Address, Username and/or Password of the Ethernet device, then click **Select**.

**Select Controller**

**Intelligent Search**  
Intelligent Search  
Searches for all controllers on the LAN

**Search by IP Address**

Controller ID	Model Name	IP Address	MAC Address	Firmware
<input type="checkbox"/> ID-1	VK2100	10.3.41.136	00:10:74:b2:01:13	2.4.232.002

**Refresh**

TELNET

IP Address  Receive message for  second

Username

Password

**OK** **Cancel**

Intelligent Search	Click to locate Control Boxes without specifying an IP address. This option only searches for Control Boxes on the same local area network. For Control Boxes across a network device, such as a router or switch, you must specify the IP address.
Search by IP address	Enter the IP address and click <b>Search</b> to locate a Control Box.
Controller ID	Use the check box to select the Controller, fill in the IP Address, Username and/or Password and then click <b>OK</b> . Next use the instructions below this table.
Refresh	Click this button to refresh the Controller ID list.
IP Address	Type the IP address of the device.
Username	Type the device's username.
Password	Type the device's password to grant access right to the controller.
Receive message for	Specifies the maximum allowed time that the device receives messages from the selected controller.

**Note:** The username and password are not required for UDP and TCP devices, and the username is not required for PJJINK devices.

Click **Retrieve** a second time, and the **Get Feedback** window appears to send the action and receive return messages from the device:

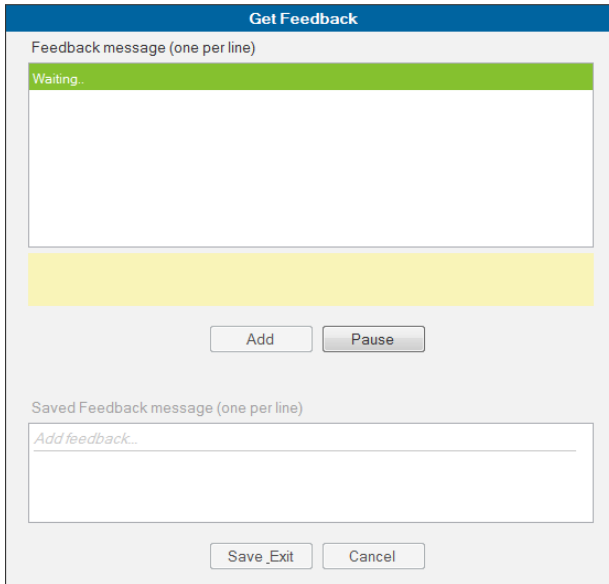

The top sections lists the Feedback message returned from the device. The bottom section lists saved Feedback messages. Once a message is received you can:

**Add** – Click to save a feedback message in the Saved Feedback message window.

**Pause / Continue** – Click to pause sending/receiving the command/return message.

**Save Exit** – Save the Feedback Message list and exit.

**Cancel** – Exit Get Feedback without saving.

**Send** – After the string is configured click to test the action. The device must be connected to the LAN for the action test to work.

Click **Send**, a pop-up window appears to select a controller. Check a box to choose a controller and enter the IP Address, Username and/or Password of the Ethernet device, then click **Select**.

**Select Controller**

Intelligent Search  
Intelligent Search  
Searches for all controllers on the LAN

Search by IP Address

Controller ID	Model Name	IP Address	MAC Address	Firmware
<input type="checkbox"/> ID-1	VK2100	10.3.41.136	00:10:74:b2:01:13	2.4.232.002

Refresh

TELNET

IP Address  Receive message for  second

Username

Password

OK Cancel

Click **Send** a second time, the **Feedback Result** window appears allowing you to select which device to send the command to. Use the radio button to choose *Send to All* or select a *drop-down menu value* (number) and click **Send**.

**Feedback Result**

Send to All

2

2

Send Cancel

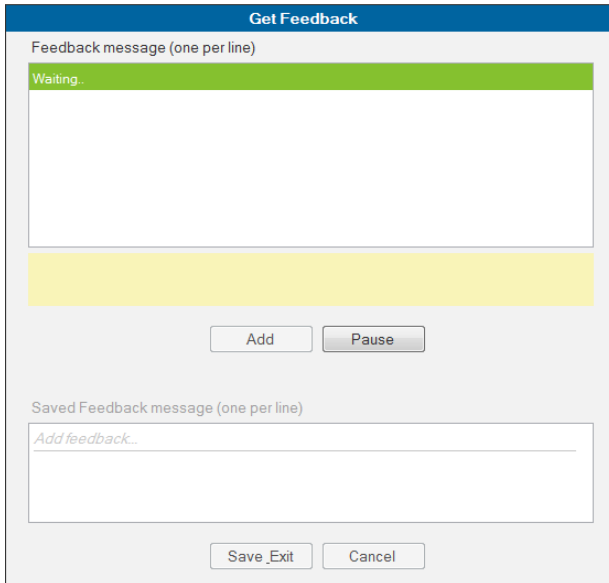

The top sections lists the Feedback message returned from the device. Once a message is received you can:

**Add** – Click to save a feedback message in the Saved Feedback message window.

**Pause / Continue** – Click to pause sending/receiving the command/return message.

**Save Exit** – Save the Feedback Message list and exit.

**Cancel** – Exit Get Feedback without saving.

5. Click **Save**; or **Save as** to use a new name.

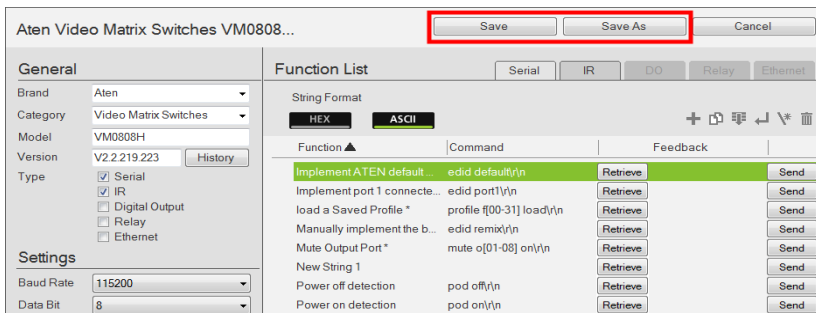

6. The device will appear in *My Library*.



## ATEN Library

The *ATEN Library* is accessed on the **Library** menu bar selection and provides the complete list of hardware devices available in the database. The You can add any device in the ATEN Library to My Library. Once a device is added to My Library, the device settings can be edited as needed.

The screenshot shows the ATEN Library interface. At the top, there is a search bar with a 'Search' button. Below the search bar are filter tabs: 'All', 'Serial', 'IR', 'DO', 'Relay', and 'Ethernet'. The main area displays a table of devices with the following columns: Brand, Category, Model, Type, and Version. Each row has a checkbox on the left for selection. At the bottom of the interface are two buttons: 'Add to My Library' and 'Cancel'.

<input type="checkbox"/>	Brand	Category	Model	Type	Version
<input type="checkbox"/>	ZONDA	TV	ZONDA 1	IR	V1.0
<input type="checkbox"/>	ZON	AUDIO	ZAC SERIES	IR	V1.0
<input type="checkbox"/>	ZON	AUDIO	ZON 1	IR	V1.0
<input type="checkbox"/>	ZENTH	SAT	SAT1576	IR	V1.0
<input type="checkbox"/>	ZENITH	TV	C25A24T	IR	V1.0
<input type="checkbox"/>	ZENITH	TV	C27A24T	IR	V1.0
<input type="checkbox"/>	ZENITH	TV	C27A25	IR	V1.0
<input type="checkbox"/>	ZENITH	TV	C27F33	IR	V1.0
<input type="checkbox"/>	ZENITH	TV	C27F43	IR	V1.0
<input type="checkbox"/>	ZENITH	TV	C27V36	IR	V1.0
<input type="checkbox"/>	ZENITH	TV	C30W47	IR	V1.0
<input type="checkbox"/>	ZENITH	TV	C32F33	IR	V1.0
<input type="checkbox"/>	ZENITH	TV	C32F43	IR	V1.0
<input type="checkbox"/>	ZENITH	TV	C32V36	IR	V1.0
<input type="checkbox"/>	ZENITH	TV	C32V37	IR	V1.0

- ◆ Use the check boxes to select devices to add to My Library. Check **All** to select all devices in the list.
- ◆ Key in word strings then click **Search** to find a device.
- ◆ Click **All**, **Serial**, **DO**, **IR**, **Relay** or **Ethernet** to filter the device list by type.
- ◆ Click **Brand**, **Category**, **Model**, **Type** or **Version** to sort the devices.
- ◆ Click **Add to My Library** to add the selected devices to My Library.
- ◆ Click **Cancel** to return to My Library.

This Page Intentionally Left Blank

# Chapter 6

## Remote PC Control Using ControlAssist

### Overview

---

ATEN Control System allows you to control PowerPoint and media files at computers installed with ControlAssist, an application that grants control right of the target computer to the Control Box. With ControlAssist installed on a target computer, you can perform actions such as controlling PowerPoint slides, playing media files, and turning on a PC (via the Wake on LAN feature) from a Viewer on a licensed mobile device. For a complete list of supported function, see *Supported PC Control Actions*, page 174.

### Specifications

---

- ◆ Viewer
  - ◆ To use ATEN Viewers on a Windows platform, make sure to install Internet Explorer version 11 or later.
- ◆ PowerPoint File Control
  - ◆ ControlAssist only supports PowerPoint files that contain 200 slides or less, and are created using Microsoft Office 2007/2010/2013, or WPS Office.
  - ◆ ControlAssist only supports the following PowerPoint file formats: pps, ppt, and pptx.
- ◆ Media File Control
  - ◆ ControlAssist only supports media files created using Windows Media Player.
  - ◆ When a media file is remotely enabled and controlled using an ATEN Viewer, the file opens in Windows Media Player and this setting can not be changed.
  - ◆ If you encounter any issues playing a media file, try install a third-party video codec.

- ◆ ControlAssist only supports control of the following media file formats:

<b>Category</b>	<b>File Formats</b>
Windows Media format	asf, wma, wmv, wm
Windows Media Metafiles	asx, was, wvx, wmx, wpl
Microsoft Digital Video Recording	dvr-ms
Windows Media Download Package	wmd
Audio Visual Interleave	avi
Moving Pictures Experts Group	mpg, mpeg, m1v, mp2, mpa, mpe, m3u
Musical Instrument Digital Interface	mid, midi, rmi
Audio Interchange File Format	aif, aifc, aiff
Sun Microsystems and NeXT	au, snd
Audio for Windows	wav
CD Audio Track	cda
Indeo Video Technology	ivf
Windows Media Player Skins	wmz, wms
QuickTime movie file	mov
MP4 audio file	m4a
MP4 video file	mp4, m4v, mp4v, 3g2, 3pg2, 3gp, 3gpp
Windows audio file	aac, adt, adts

## Setting Up Remote PC Control

---

Follow the steps below to set up one or more computers for remote control.

1. Make sure you have installed Microsoft Visual C++ Redistributable for Visual Studio 2015 to the target computer. To download the package, go to <https://www.microsoft.com/en-us/download/details.aspx?id=48145>
2. Install ControlAssist to the computer you wish to control. For detailed steps, see *Installing ControlAssist to a Computer*, page 167.
3. Add the computer into the control system. For detailed steps, see *Adding the Computer to the Control System*, page 169.
4. Create a control interface to be used on a licensed mobile device.
  - ◆ For detailed steps, see *Configuring a Control Interface*, page 171.
  - ◆ For details on licenses, see *Licenses for Mobile Control*, page 47.

### Installing ControlAssist to a Computer

Follow the steps below to install ControlAssist, a program that helps to establish communication to ATEN Control Boxes, to the computers you wish to control.

1. Download ControlAssist.
  - a) Visit the ATEN download page:  
<https://www.aten.com/global/en/supportcenter/downloads/>
  - b) Search for “VK6000”. A list of downloads for VK6000 appears.
  - c) Click **ControlAssist\_Vx.x.xxx.zip** to download.
2. From the downloaded file, double-click **ControlAssist\_Setup** to install the program. An installation wizard appears.
3. Follow the on-screen instruction to complete the installation.

4. When the installation is complete, the ControlAssist program runs automatically in the system tray.

**Note:**

- ◆ Keep the ControlAssist program enabled in the system tray to allow the Control Box to establish connection with the computer.
- ◆ By default, ControlAssist uses the following connection settings. To change the settings, right-click  in the system tray and select **Settings**.

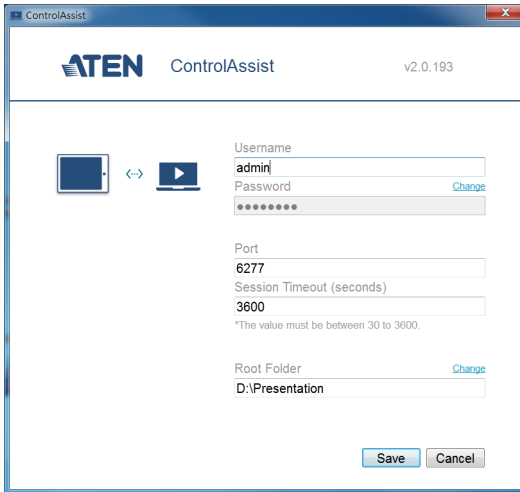

Setting	Default	Description
Username	admin	The credentials required for ATEN Control Box to establish connection with the computer.
Password	password	<b>Note:</b> To change the username and password, make sure to log in the computer using an Administrator account.
Port	6277	The port through which ATEN Configurator establishes connection with the ControlAssist-installed computer.
Session timeout	3600	The maximal time allowed for the Control Box to establish connection with ControlAssist.
Root Folder	N/A	This field specifies the computer path under which files are display in the PowerPoint Control and Media templates' file list. To display files at the computer's partition level, type <b>%MY_COMPUTER%</b> in this field.

## Adding the Computer to the Control System

After you have installed ControlAssist to the computer you wish to control, follow the steps below to establish connection between the Control Box and the target computer.

1. From ATEN Configurator, locate and open your project file.
2. Click the **Device** tab, and from the Ethernet device type category, click on a blank device or click **Add More Devices** to add one.
3. Click **Library**. This window appears.

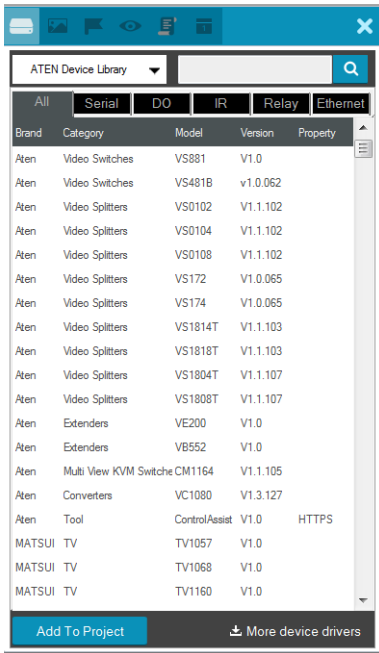

- Use the search box to search for “controlassist” to load the ControlAssist database. This screen appears.

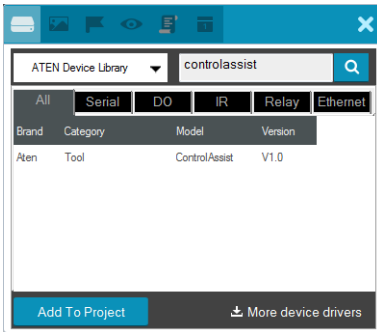

- Click **Add to Project**. This computer, identified as a device installed with ControlAssist, appears in the Device Configuration List.

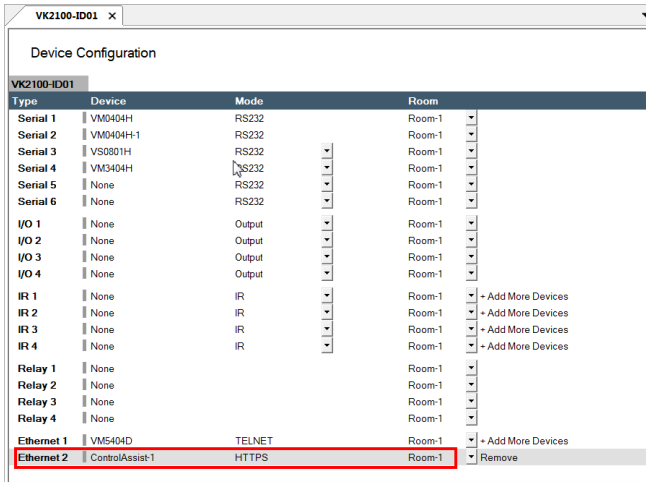

- Select the newly added device and configure the Properties settings on the right of the interface.

**Hint:** For the device name, use a name that identifies the PC.

For details on Properties settings, see *Properties*, page 74.



## Configuring a Control Interface

### Example 1:

Follow the steps below to create a control interface that allows you to browse and play any file from the specified root folder (see page 167) in the target computer. You can follow the same logic for creating a media control page.

1. In the **Design** tab, make sure your home page contains a presentation button and the viewer contains a PowerPoint page.

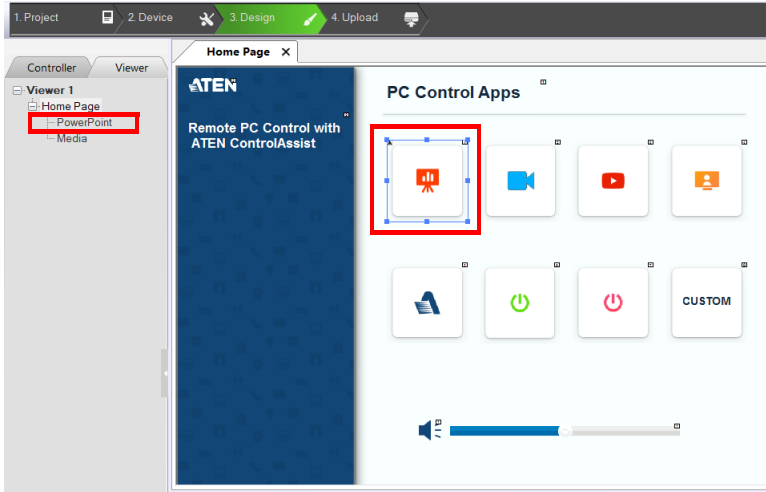

2. Configure the button to have it link to the PowerPoint page if pressed in the Viewer.
  - a) Click the presentation button.
  - b) Select **Link** and then double-click the **PowerPoint** page.

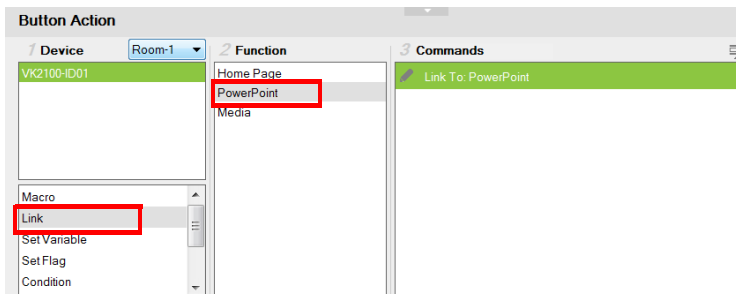

3. Configure the PowerPoint page if you did not use a built-in Viewer template.
  - a) In the left sidebar, click **PowerPoint**.
  - b) In the PowerPoint page, right-click any blank spot and select **PowerPoint Control Template**. A pre-made screen is added.

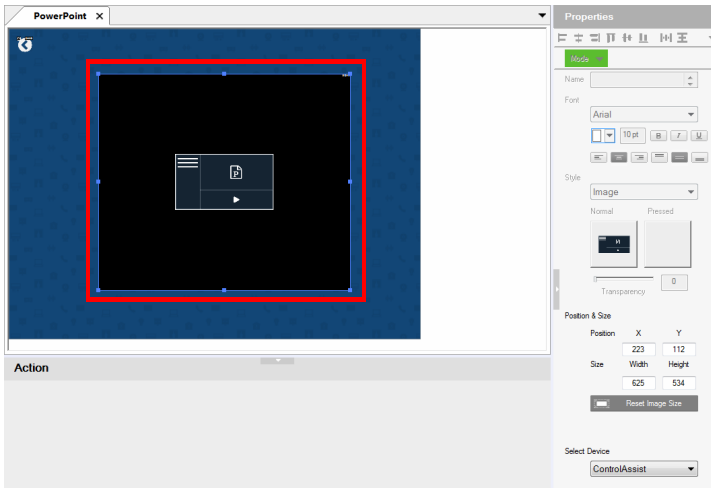

- c) In the Properties column, use the **Select Device** drop-down menu to select the PC that stores the PowerPoint files you want to play.

**Example 2:**

Follow the steps below to create a quick access button for opening and playing a specific PowerPoint file. You can follow the same logic to create a button for opening and playing a specific media file.

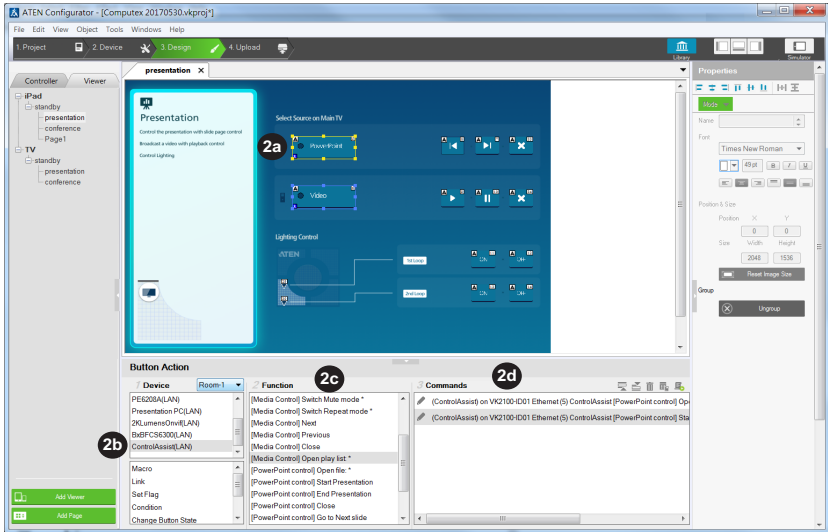

1. Create an outlook for the interface.
  - a) In ATEN Configurator, click the **Design** tab.
  - b) Click **Add Page** and rename the page to “presentation”.
  - c) Customize the interface and add control buttons using the **Properties** settings in the right-hand column. For details, see *Properties*, page 74.
2. Define the action of each button. For example, for the **PowerPoint** button to open and start a slide show when pressed, do the following:
  - a) In the preview pane, click the **PowerPoint** button.
  - b) Select **ControlAssist (LAN)**.
  - c) Double-click **[PowerPoint] Open file** and then **[PowerPoint] Start presentation**.
  - d) Configure the commands and arrange them in the order of execution.

**Tip:** The asterisk (\*) at the end of a Function indicates that it requires configuration in the Commands column.

For details on supported control actions, see *Supported PC Control Actions*, page 174.

3. From the **Upload** tab, deploy and back up the project to the Control Box. For details, see *Upload*, page 142.

## Supported PC Control Actions

Command	Function
<b>[Media Control]</b>	
<b>Note:</b> The commands in this group apply to Windows Media Player only.	
Open file	Opens and plays the specified file in Windows Media Player.*
Play	Plays the opened file in Windows Media Player.
Pause	Pauses the playback.
Stop	Stops the playback.
Switch Fullscreen mode	Enables or disables the player to full-screen display.
Volume	Adjusts the player's volume up or down.
Switch Mute mode	Enables or disables mute mode.
Switch Repeat mode	Enables or disables repeated play.
Next	Plays next in the playlist.
Previous	Plays previous in the playlist.
Close	Closes the player.
Open Playlist	Opens and plays the specified playlist in Windows Media Player.*
Set volume to	Sets the player to a specified volume.
<b>[PowerPoint Control]</b>	
Open File	Opens the specified PowerPoint file.*
Start Presentation	Starts the slide show of the specified PowerPoint file.
End Presentation	Ends the slide show of the specified PowerPoint file.
Close	Closes the opened PowerPoint file.
Go to Next Slide	Goes to the next slide.
Go to Previous Slide	Goes to the previous slide.
Go to Slide	Goes to a specified slide number.
<b>Others</b>	
Shut down PC	Shuts down the computer.
Open URL	Opens a specified URL.
Open File	Opens a specified file saved in the target computer.
Run Program	Runs an application.

---

**Note:**

- ◆ Adhere to the following guidelines when specifying file paths:
    - ◆ Include the file name and file extension of the target file.
    - ◆ Use double backward slashes between folder levels.
    - ◆ If the file path contains space, put the file path in double quotations.
    - ◆ The following are examples of valid file paths:
      - “C:\\ControlAssist\\Presentation.pptx”
      - “C:\\ControlAssist\\Presentation Demo.pptx”
-

This Page Intentionally Left Blank

# Chapter 7

## ATEN Control System App

### Overview



---

The ATEN Control System App is a free app for mobile devices which can be downloaded from Google Play or the Apple App Store. The app allows you to download the Profiles from a Control Box. These Profiles provide the interface (Viewers) for remote control of hardware devices.

### Installing the App

---

To install the ATEN Control System App on a mobile device, do the following:

1. From the mobile device, tap the **App Store**  or Google Play  icon.
2. In the search box, type “aten control”.
3. Tap *ATEN Control System*, and then download and install the app.
4. The ATEN Control System icon  appears on the mobile device.
5. Tap the icon to open the app.

---

**Note:** The ATEN Control System App is supported on mobile devices installed with Android 4.2.2 and higher, iOS9 and higher, or Windows 7 and higher.

---

### Button Sounds

After you install the app, go to the mobile device *Settings* and find the **ATEN Control** so that you can enable/disable the *Button Sound* setting.

## ATEN Control System App

---

When you open the ATEN Control System app for the first time, the default *Welcome* screen appears:

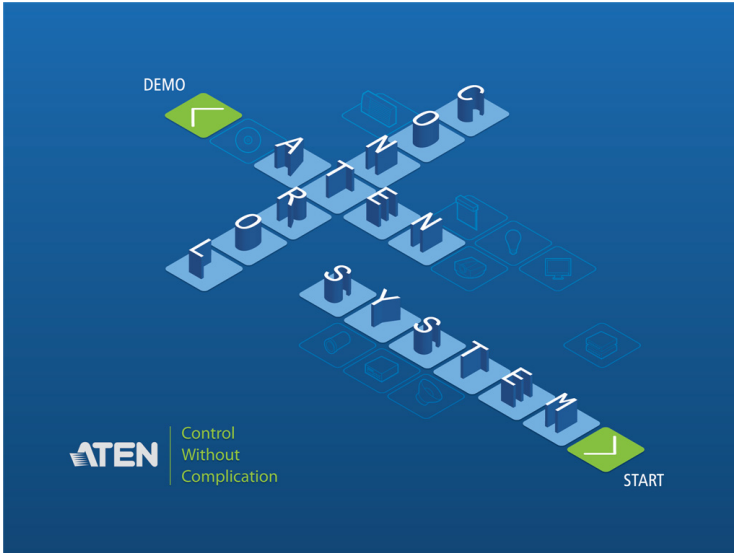

Tap **Demo** to try the ATEN Control System app. Tap **Start** to find a Control Box and download viewer profiles (see *Welcome*, page 182).

---

**Note:** The default Welcome screen appears until a viewer profile is downloaded to the mobile device. After a viewer profile is downloaded, the default Welcome screen will reappear only if the app is reinstalled, which will also delete all viewer profiles.

---



## Demo

The *Demo* page provides a preview of the ATEN Control System app with two sample rooms. Tap either room to view the controls of different hardware devices. Tap **Quit Demo** at the top right corner to exit.

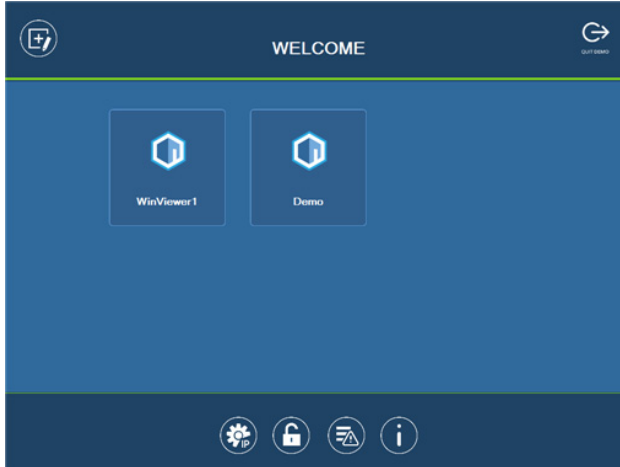

Select a viewer profile or press any of the buttons on the Welcome page to demo the app. The first profile's name will depend on the OS of the device.

### WinViewer1 / iPad / Android1



This demo shows a Conference call interface with controls for a **Projector**, **Screen** and **Lighting**. Tap any of the device icons to open the control page.

## Control Pages



The images above show the **Main** page and pages for the **Projector**, **Screen** and **Lights**.

## Demo

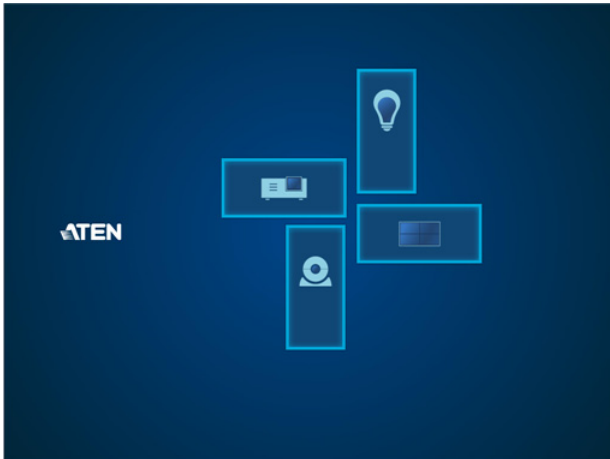

This demo shows different buttons that can be pressed to control the **Projector**, **Lights**, **Video Wall** and **Camera**. Tap the icons to view control pages for each device. Tap the **Quit Demo** icon to return to the previous page, or press on the viewer page background until the logout dialog appears.

## Control Pages

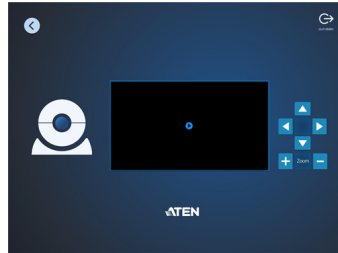
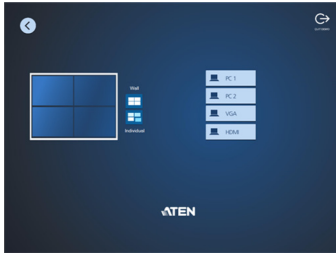
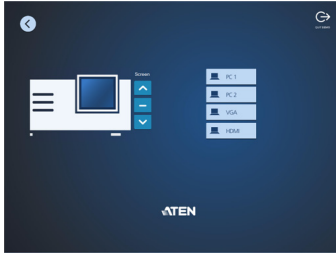



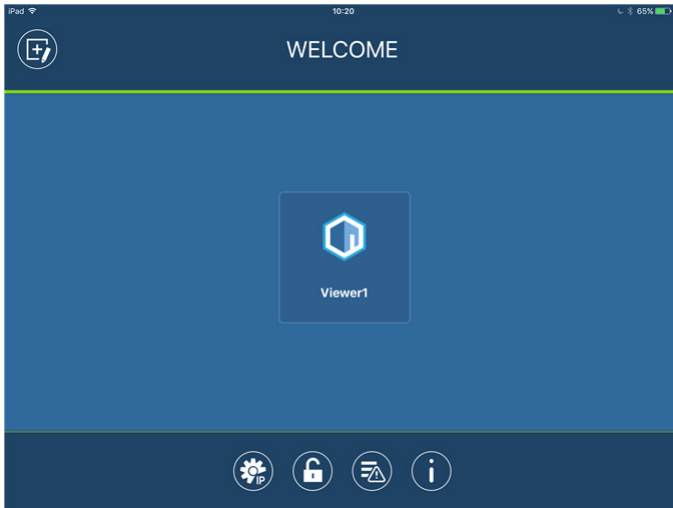

The images above show control pages for the **Projector**, **Lights**, **Video Wall** and **Camera** in *Demo*. Tap the **Home** icon in the lower left corner to return to the previous page, or press on the viewer page background until the logout dialog appears.

## Welcome

The *Welcome* screen is the home screen of the ATEN Control System app. It lists the viewer profiles and provides administrative options. Tap a viewer profile to open the controls for a room (see *Design*, page 82), or use the administrative options listed below.





Icon	Description
	<p><b>Edit Viewer Profile</b> – This page provides options to add, update and remove viewer profiles. See page 183 for details.</p>
	<p><b>Manage IP</b> – This page provides options to configure network settings for Control Boxes and LAN devices. See page 184 for details.</p>
	<p><b>Set Password</b> – This page provides options to set a password for access to the Welcome page when a viewer profile is in use. See page 187 for details.</p>
	<p><b>Log Report</b> – This page provides an error log to troubleshoot connectivity issues. See page 188 for details.</p>
	<p><b>Information</b> – This page provides information about the ATEN Control System's software version. See page 190 for details.</p>

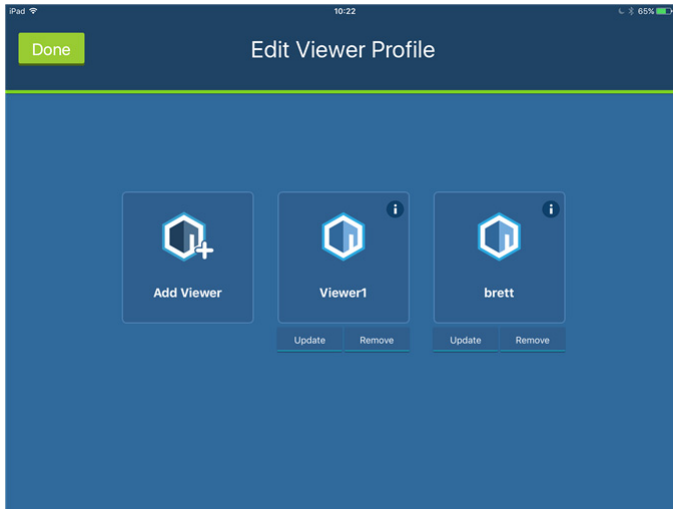

## Edit Viewer Profile

The *Edit Viewer Profile* page allows you to add, update and remove viewer profiles. To download viewer profiles, tap **Add Viewer** (see *Set Password*, page 187).



Add Viewer	Tap <b>Add Viewer</b> to download viewer profiles from the <i>Download Viewer Profile</i> page. See page 191 for details.
	Tap the <i>Information</i> icon to view the <b>MAC Address</b> , <b>IP Address</b> and <b>Controller ID</b> of the Control Box associated with the viewer profile.
Update	Tap <b>Update</b> to connect to the Control Box and download an updated version of the viewer profile. After the update, the "Downloaded Successfully" prompt will appear
Remove	Tap <b>Remove</b> to delete the viewer profile. A dialog box will appear to confirm deletion of the viewer profile. Tap <b>Delete</b> to remove the viewer profile*, or <b>Cancel</b> to cancel the deletion. <b>Note:</b> Viewer profiles are only deleted on the mobile device, and will still be available on the Control Box.
Done	Tap Done to return to the Welcome page.



## **Manage LAN Device**

The *Manage LAN Device* page allows you to edit network settings for the Control Boxes and LAN devices added in the Configurator software (see *Device Library*, page 73).

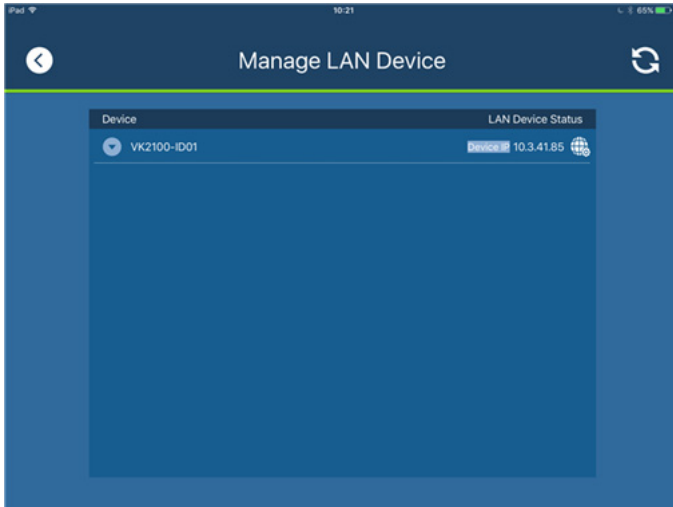

Tap to expand Control Boxes to view connected LAN devices.



Tap to open the web GUI (see *Browser Operation*, page 43).

Depending on the LAN device you select, different options are available. Tap on a device to open the settings page. Use **Edit** to change settings, **Apply** to save or **OK** to exit.

## Controller

VK2100-ID01	Edit
Device IP	<input type="text" value="10.341.85"/>
Router IP	<input type="text"/>
MAC Address	<input type="text" value="00:10:74:b2:01:99"/>

**Done**

VK2100-ID01	
Device IP	<input type="text" value="192.168.0.8"/>
Router IP	<input type="text"/>
MAC Address	<input type="text" value="00:10:74:b2:01:99"/>

**Apply**   **Cancel**

## PJLink Projector

PJLINK	Edit
IP Address	<input type="text" value="192.168.11.12"/>
Port	<input type="text" value="4352"/>
Password	<input type="password" value="*****"/>

**Done**

PJLINK	
IP Address	<input type="text" value="192.168.11.12"/>
Port	<input type="text" value="4352"/>
Password	<input type="password" value="*****"/>
<input type="checkbox"/> Show Password	

**Apply**   **Cancel**

## Telnet

TELNET	Edit
IP Address	<input type="text" value="192.168.11.12"/>
Port	<input type="text" value="4352"/>
Username	<input type="text" value="User 82"/>
Password	<input type="password" value="*****"/>

**Done**

TELNET	
IP Address	<input type="text" value="192.168.11.12"/>
Port	<input type="text" value="4352"/>
Username	<input type="text" value="User 82"/>
Password	<input type="password" value="*****"/>
<input type="checkbox"/> Show Password	

**Apply**   **Cancel**

## ONVIF

ONVIF **Edit**

---

**IP Address**

**Username**

**Password**

---

**Done**

ONVIF

---

**IP Address**

**Username**

**Password**

Show Password

---

**Apply** **Cancel**

## TCP

TCP Device **Edit**

---

**IP Address**

**Port**

---

**Done**

TCP Device

---

**IP Address**

**Port**

---

**Apply** **Cancel**

## UDP

UDP Device **Edit**

---

**IP Address**

**Port**

---

**Done**

UDP Device

---

**IP Address**

**Port**

---

**Apply** **Cancel**





## Set Password

The *Set Password* page sets a password to access the Welcome page from a viewer profile. This prevents unauthorized users from changing the app settings. Users will be prompted for a password before they exit viewer profiles to access the Welcome page.

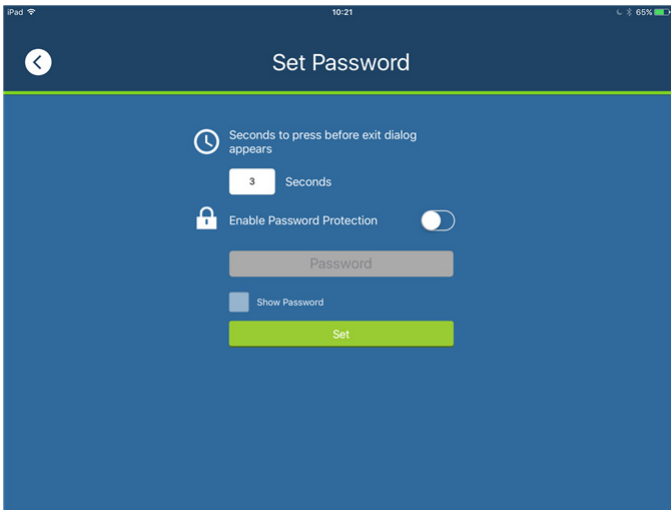

Slide the **Enable Password Protect** button, enter a password in the box and tap **Set**. The *Show Password* option appears after you check enable Password Protect, allowing you to display the characters typed in for the password. Enter a number in *Seconds to press before exit dialog appears* to set the amount of time to pass when pressing on a viewer page before a window appears asking if you want to exit. Tap **Back** to exit.



## **Log Report**

The *Log Report* page lists information and errors which can be used to troubleshoot issues. Tap and drag the list to scroll through the logs. Tap **Back** to exit.

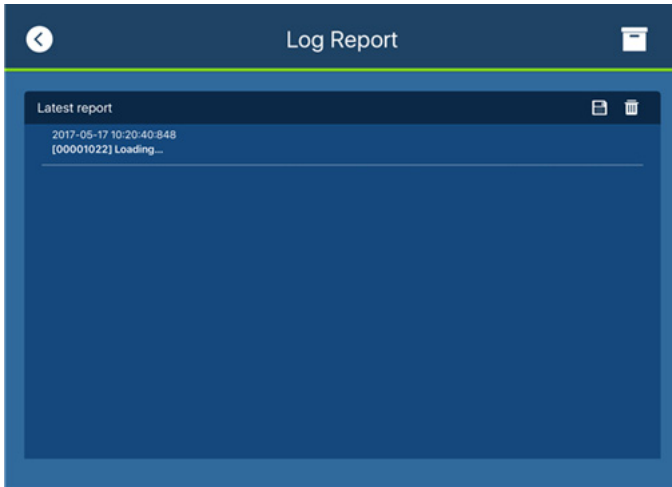

Tap **Save** to save the log file.



Tap **Report History** to view saved logs (see page 189).



Tap **Delete** to delete the log information.



Tap **Back** to exit.



## Report History

When you tap **Report History**, you can view and export logs. Saved log files are listed by date in the left column. Tap a log file to view it in the window to the right. Tap and drag the list to scroll through the logs. Tap **Back** to exit.

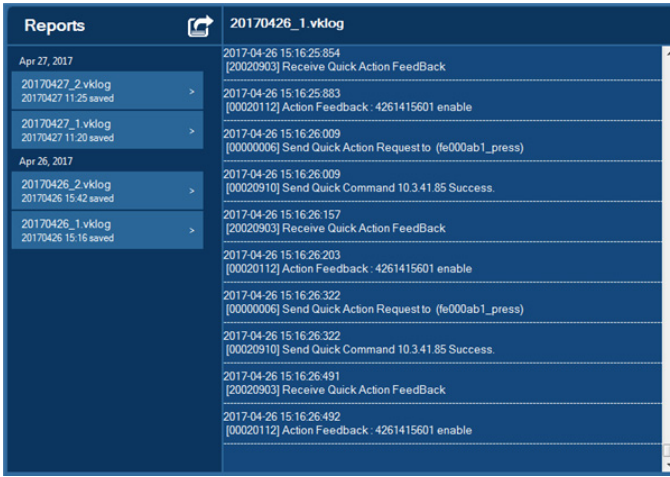

Tap **Export** to send the log as an e-mail attachment.



## **Information**

The *Information* page displays the ATEN Control System's version.





## Download Viewer Profile

The *Download Viewer Profile* page allows you to search for Control Boxes and download viewer profiles. This page is accessed from *Welcome* → *Edit Viewer Profile* → **Add Viewer**.

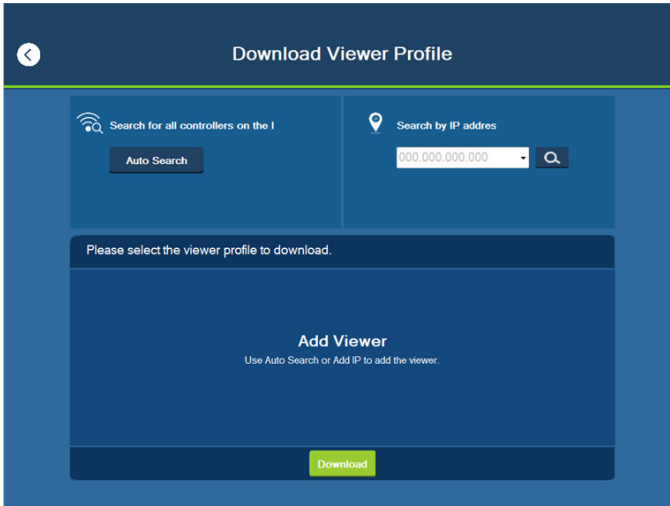



Search by IP Address	Tap to enter a Control Box's IP address, then tap the Search icon to find it. When Control Boxes are found on the network, they are listed in the Add Viewer box. A <b>Search History</b> drop-down menu will appear for previously searched IP addresses.
Auto Search	Auto Search allows you to search for Control Boxes without specifying an IP address. The Control Box must be powered on and connected to the same local network.
Add Viewer	This panel lists the Control Boxes that have been found on the network. Each Control Box lists viewer profiles that can be downloaded to the mobile device. To upload viewer profiles to a Control Box, see <i>Upload</i> , page 142.
Back Icon	Back returns you to the Welcome page.
Download	After you select the viewer profiles you want to download, click <b>Download</b> to start the process.

**Download**

**Downloading Profiles**

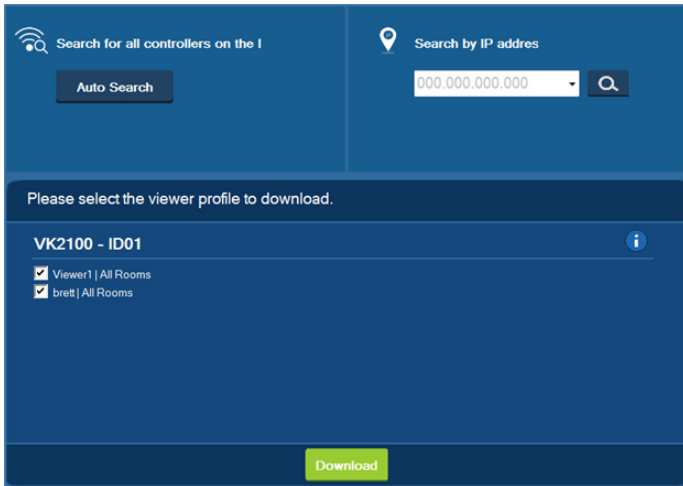
When Control Boxes are found, they appear in the *Add Viewer* panel. Check the boxes of the viewer profiles you would like to download, then tap **Download**.



<p>Add Viewer</p>	<p>The main window lists the Control Boxes that have been found on the network. Under each Control Box is a list of viewer profiles with a check box.</p> <p>Use the check boxes to select the viewer profiles you want to download, then click <b>Download</b>. If the Lock icon appears, you will be prompted to enter the access key.</p> <p>After viewer profiles download, the “Downloaded Successfully” prompt appears. Tap <b>Done</b> to return to the Welcome page where the viewer profiles will be listed.</p> <p><b>Note:</b> After you download a viewer profile to the mobile device, the default Welcome screen no longer appears.</p>
<p>Access Key</p>	<p>When the a viewer profile requires an access key a window appears prompting you to enter the key. Enter the correct access key and then click <b>OK</b> to download the viewer profiles from the Control Box. To set the access key, see <i>Upload</i>, page 142.</p>
	<p>Tap the Information icon to view the <b>IP Address</b>, <b>MAC Address</b> and <b>License</b> information of the Control Box. The license information provides the total number of licenses available and the number in use.</p>

## Safety Instructions

---

### General

- ◆ Read all of these instructions. Save them for future reference.
- ◆ Follow all warnings and instructions marked on the device.
- ◆ This product is for indoor use only.
- ◆ Do not place the device on any unstable surface (cart, stand, table, etc.). If the device falls, serious damage will result.
- ◆ Caution: Risk of explosion if the battery is replaced by an incorrect type. Always dispose of used batteries according to the proper instructions.
- ◆ Do not use the device near water.
- ◆ Do not place the device near, or over, radiators or heat registers.
- ◆ The device cabinet is provided with slots and openings to allow for adequate ventilation. To ensure reliable operation, and to protect against overheating, these openings must never be blocked or covered.
- ◆ The device should never be placed on a soft surface (bed, sofa, rug, etc.) as this will block its ventilation openings. Likewise, the device should not be placed in a built in enclosure unless adequate ventilation has been provided.
- ◆ Never spill liquid of any kind on the device.
- ◆ Unplug the device from the wall outlet before cleaning. Do not use liquid or aerosol cleaners. Use a damp cloth for cleaning.
- ◆ The device should be operated from the type of power source indicated on the marking label. If you are not sure of the type of power available, consult your dealer or local power company.
- ◆ The device is designed for IT power distribution systems with 230V phase-to-phase voltage.
- ◆ To prevent damage to your installation it is important that all devices are properly grounded.
- ◆ The device is equipped with a 3-wire grounding type plug. This is a safety feature. If you are unable to insert the plug into the outlet, contact your electrician to replace your obsolete outlet. Do not attempt to defeat the purpose of the grounding-type plug. Always follow your local/national wiring codes.

- ◆ Do not allow anything to rest on the power cord or cables. Route the power cord and cables so that they cannot be stepped on or tripped over.
- ◆ If an extension cord is used with this device make sure that the total of the ampere ratings of all products used on this cord does not exceed the extension cord ampere rating. Make sure that the total of all products plugged into the wall outlet does not exceed 15 amperes.
- ◆ To help protect your system from sudden, transient increases and decreases in electrical power, use a surge suppressor, line conditioner, or un-interruptible power supply (UPS).
- ◆ Position system cables and power cables carefully; Be sure that nothing rests on any cables.
- ◆ Never push objects of any kind into or through cabinet slots. They may touch dangerous voltage points or short out parts resulting in a risk of fire or electrical shock.
- ◆ Do not attempt to service the device yourself. Refer all servicing to qualified service personnel.
- ◆ If the following conditions occur, unplug the device from the wall outlet and bring it to qualified service personnel for repair.
  - ◆ The power cord or plug has become damaged or frayed.
  - ◆ Liquid has been spilled into the device.
  - ◆ The device has been exposed to rain or water.
  - ◆ The device has been dropped, or the cabinet has been damaged.
  - ◆ The device exhibits a distinct change in performance, indicating a need for service.
  - ◆ The device does not operate normally when the operating instructions are followed.
- ◆ Only adjust those controls that are covered in the operating instructions. Improper adjustment of other controls may result in damage that will require extensive work by a qualified technician to repair.



## **Rack Mounting**

- ◆ Before working on the rack, make sure that the stabilizers are secured to the rack, extended to the floor, and that the full weight of the rack rests on the floor. Install front and side stabilizers on a single rack or front stabilizers for joined multiple racks before working on the rack.
- ◆ Always load the rack from the bottom up, and load the heaviest item in the rack first.
- ◆ Make sure that the rack is level and stable before extending a device from the rack.
- ◆ Use caution when pressing the device rail release latches and sliding a device into or out of a rack; the slide rails can pinch your fingers.
- ◆ After a device is inserted into the rack, carefully extend the rail into a locking position, and then slide the device into the rack.
- ◆ Do not overload the AC supply branch circuit that provides power to the rack. The total rack load should not exceed 80 percent of the branch circuit rating.
- ◆ Make sure that all equipment used on the rack – including power strips and other electrical connectors – is properly grounded.
- ◆ Ensure that proper airflow is provided to devices in the rack.
- ◆ Ensure that the operating ambient temperature of the rack environment does not exceed the maximum ambient temperature specified for the equipment by the manufacturer.
- ◆ Do not step on or stand on any device when servicing other devices in a rack.

## Technical Support

---

### International

- ◆ For online technical support – including troubleshooting, documentation, and software updates: **<http://eservice.aten.com>**
- ◆ For telephone support, see *Telephone Support*, page iii:

### North America

Email Support		<a href="mailto:support@aten-usa.com">support@aten-usa.com</a>
Online Technical Support	Troubleshooting Documentation Software Updates	<a href="https://eservice.aten.com">https://eservice.aten.com</a>
Telephone Support		1-888-999-ATEN ext 4988

When you contact us, please have the following information ready beforehand:

- ◆ Product model number, serial number, and date of purchase.
- ◆ Your computer configuration, including operating system, revision level, expansion cards, and software.
- ◆ Any error messages displayed at the time the error occurred.
- ◆ The sequence of operations that led up to the error.
- ◆ Any other information you feel may be of help.

## Datapoint Types

ATEN Control System (V2.3) supports the following KNX Datapoint Types (DPT):

DPT ID	DPT Format	DPT Name
1.001	B <sub>1</sub>	DPT_Switch
1.002	B <sub>1</sub>	DPT_Bool
1.003	B <sub>1</sub>	DPT_Enable
1.004	B <sub>1</sub>	DPT_Ramp
1.005	B <sub>1</sub>	DPT_Alarm
1.006	B <sub>1</sub>	DPT_BinaryValue
1.007	B <sub>1</sub>	DPT_Step
1.008	B <sub>1</sub>	DPT_UpDown
1.009	B <sub>1</sub>	DPT_OpenClose
1.010	B <sub>1</sub>	DPT_Start
1.011	B <sub>1</sub>	DPT_State
1.012	B <sub>1</sub>	DPT_Invert
1.013	B <sub>1</sub>	DPT_DimSendStyle
1.014	B <sub>1</sub>	DPT_InputSource
1.015	B <sub>1</sub>	DPT_Reset
1.016	B <sub>1</sub>	DPT_Ack
1.017	B <sub>1</sub>	DPT_Trigger
1.018	B <sub>1</sub>	DPT_Occupancy
1.019	B <sub>1</sub>	DPT_Window_Door
1.021	B <sub>1</sub>	DPT_LogicalFunction
1.022	B <sub>1</sub>	DPT_Scene_AB
1.023	B <sub>1</sub>	DPT_ShutterBlinds_Mode
1.100	B <sub>1</sub>	DPT_Heat/Cool
2.001	B <sub>2</sub>	DPT_Switch_Control
2.002	B <sub>2</sub>	DPT_Bool_Control
2.003	B <sub>2</sub>	DPT_Enable_Control

DPT ID	DPT Format	DPT Name
2.004	B <sub>2</sub>	DPT_Ramp_Control
2.005	B <sub>2</sub>	DPT_Alarm_Control
2.006	B <sub>2</sub>	DPT_BinaryValue_Control
2.007	B <sub>2</sub>	DPT_Step_Control
2.008	B <sub>2</sub>	DPT_Direction1_Control
2.009	B <sub>2</sub>	DPT_Direction2_Control
2.010	B <sub>2</sub>	DPT_Start_Control
2.011	B <sub>2</sub>	DPT_State_Control
2.012	B <sub>2</sub>	DPT_Invert_Control
3.007	B <sub>1</sub> U <sub>3</sub>	DPT_Control_Dimming
3.008	B <sub>1</sub> U <sub>3</sub>	DPT_Control_Blinds
4.001	A <sub>8</sub>	DPT_ASCII
4.002	A <sub>8</sub>	DPT_Char_8859_1
5.001	U <sub>8</sub>	DPT_Scaling
5.003	U <sub>8</sub>	DPT_Angle
5.004	U <sub>8</sub>	DPT_Percent_U8
5.005	U <sub>8</sub>	DPT_DecimalFactor
5.006	U <sub>8</sub>	DPT_Tariff
5.010	U <sub>8</sub>	DPT_Value_1_Ucount
6.001	V <sub>8</sub>	DPT_Percent_V8
6.010	V <sub>8</sub>	DPT_Value_1_Count
6.020	B <sub>5</sub> N <sub>3</sub>	DPT_Status_Mode3
7.013	U <sub>16</sub>	DPT_Brightness
8.011	V <sub>16</sub>	DPT_Rotation_Angle
9.001	F <sub>16</sub>	DPT_Value_Temp
18.001	B <sub>1</sub> R <sub>1</sub> U <sub>6</sub>	DPT_SceneControl
20.100	N <sub>8</sub>	DPT_FuelType
20.101	N <sub>8</sub>	DPT_BurnerType
20.102	N <sub>8</sub>	DPT_HVACMode
20.103	N <sub>8</sub>	DPT_DHWMode

---

<b>DPT ID</b>	<b>DPT Format</b>	<b>DPT Name</b>
20.104	N <sub>8</sub>	DPT_LoadPriority
20.105	N <sub>8</sub>	DPT_HVACContrMode
20.106	N <sub>8</sub>	DPT_HVACEmergMode
20.107	N <sub>8</sub>	DPT_ChangeoverMode
20.108	N <sub>8</sub>	DPT_ValveMode
20.109	N <sub>8</sub>	DPT_DamperMode
20.110	N <sub>8</sub>	DPT_HeaterMode
20.111	N <sub>8</sub>	DPT_FanMode
20.112	N <sub>8</sub>	DPT_MasterSlaveMode
20.113	N <sub>8</sub>	DPT_StatusRoomSetp
23.001	N <sub>2</sub>	DPT_OnOff_Action
23.002	N <sub>2</sub>	DPT_Alarm_Reaction
23.003	N <sub>2</sub>	DPT_UpDown_Action
23.102	N <sub>2</sub>	DPT_HVAC_PB_Action

---

# Specifications

## VK2100

Function		VK2100
Interface	Serial	4 x Programmable Bi-directional RS-232/422/485 Ports (4 x DB9 Male Connectors, Configurable via Pin Assignments)  Baud Rate: 300 to 115200 (default: 9600) Data Bit: 8 (default) or 7 Stop Bit: 1 (default) or 2 Parity: None (default), Even or Odd Flow Control: None (default) RTS/CTS
		2 x Bi-directional RS-232 Ports (2 x 3-Pole Terminal Block Connectors) Baud Rate: 300 to 115200 (default: 9600) Data Bit: 8 (default) or 7 Stop Bit: 1 (default) or 2 Parity: None (default), Even or Odd
	IR/Serial	4 x Programmable IR / Uni-directional RS-232 Ports (2 x 4-Pole Terminal Block Connectors)  IR: TTL level (0 to 5 V) Carrier Frequency: 10KHz~455KHz  Serial: Uni-directional RS-232 ( + - 5 V) Baud Rate: 300 to 115200 (default: 9600) Data Bit: 8 (default) or 7 Stop Bit: 1 (default) or 2 Parity: None (default), Even or Odd
	I/O	4 x Programmable Digital Input / Output Channels (1 x 5-Pole Terminal Block Connector)  Digital Output: 250 mA sink from 12 VDC  Digital Input: VDC Mode Input Voltage Range: 0 to 24 VDC Programmable Range: 1 to 24 VDC Dry Contact Mode: Pull-up 2k ohms to + 12 VDC
	Relay	4 x Relay Channels (2 x 4-Pole Terminal Block Connector) Normally Open, Isolated Relays Contact Rating: Max 24 VDC, 2A
	VDC	4 x 12 VDC Output Ports (2 x 4-Pole Terminal Block Connectors) Power Supply: 12 VDC, 2A Max (Shared By 4 Ports)
Connectors	Ethernet	1 x RJ-45 Female, 10/100Base-T
	USB	1 x USB Type A Female (White)
	Power	1 x 3-prong AC power socket

Function		VK2100	
Switches	Controller ID		1 x 16-Segment Switch
	Power		1 x Rocker Switch
	Reset		1 x Semi-recessed pushbutton
LEDs	Relay		4 (Green)
	IR / Serial		4 (Green)
	I/O		4 (Green)
	Serial	RX	6 (Green)
		TX	6 (Green)
	Ethernet	Link	1 (Green)
		Act	1 (Green)
	DC Output Overload		1 (Orange)
	IR Learn		1 (Green)
	USB		1 (Green / Orange)
	Power		1 (Green)
IR Receiver		1 x IR Receiver Port	
I/P Rating		100-240 VAC, 50-60 Hz	
Power Consumption		40 Watt	
Environment	Operating Temp.		0–50°C
	Storage Temp.		-20–60°C
	Humidity		0–80% RH, Non-condensing
Physical Properties	Housing		Metal
	Weight		2.64 kg
	Dimensions (L x W x H)		43.72 x 16.32 x 4.40 cm
Licenses for mobile control	No. of Free Licenses		2
	Max. No. of Allowed Licenses		10

## VK1100

Function		VK1100	
Interface	Serial	2 x Programmable Bi-directional RS-232/422/485 Ports (2 x DB9 Male Connectors, Configurable via Pin Assignments)  Baud Rate: 300 to 115200 (default: 9600) Data Bit: 8 (default) or 7 Stop Bit: 1 (default) or 2 Parity: None (default), Even or Odd Flow Control: None (default) RTS/CTS	
	IR/Serial	2 x Programmable IR / Uni-directional RS-232 Ports (1 x 3-Pole Terminal Block Connectors)  IR: TTL level (0 to 5 V) Carrier Frequency: 10KHz~455KHz  Serial: Uni-directional RS-232 (0-5 V) Baud Rate: 300 to 115200 (default: 9600) Data Bit: 8 (default) or 7 Stop Bit: 1 (default) or 2 Parity: None (default), Even or Odd	
	Relay	4 x Relay Channels (2 x 4-Pole Terminal Block Connector) Normally Open, Isolated Relays Contact Rating: Max 24 VDC, 2A	
	VDC	1 x 12 VDC Output Ports (1 x 2-Pole Terminal Block Connectors) Power Supply: 12 VDC, 1A Max	
Connectors	Ethernet	1 x RJ-45 Female, 10/100Base-T	
	USB	1 x USB Type A Female (White)	
	Power	1 x 3-prong AC power socket	
Switches	Controller ID	1 x 16-Segment Switch	
	Power	1 x Rocker Switch	
	Reset	1 x Semi-recessed pushbutton	
LEDs	Relay	4 (Green)	
	IR / Serial	2 (Green)	
	Serial	RX	2 (Green)
		TX	2 (Green)
	Ethernet	Link	1 (Green)
		Act	1 (Green)
	DC Output Overload	1 (Orange)	
	IR Learn	1 (Green)	
USB	1 (Green / Orange)		
Power	1 (Green)		
IR Receiver		1 x IR Receiver Port	
I/P Rating		100-240 VAC, 50-60 Hz	



---

<b>Function</b>		<b>VK1100</b>
Power Consumption		20 Watts
Environment	Operating Temp.	0–50°C
	Storage Temp.	-20–60°C
	Humidity	0–80% RH, Non-condensing
Physical Properties	Housing	Metal
	Weight	1.19 kg
	Dimensions (L x W x H)	21.50 x 16.23 x 4.18 cm
Licenses for mobile control	No. of Free Licenses	2
	Max. No. of Allowed Licenses	10

---

## Limited Warranty

---

ATEN warrants its hardware in the country of purchase against flaws in materials and workmanship for a Warranty Period of two [2] years (warranty period may vary in certain regions/countries) commencing on the date of original purchase. This warranty period includes the LCD panel of ATEN LCD KVM switches. Select products are warranted for an additional year (see *A+ Warranty* for further details). Cables and accessories are not covered by the Standard Warranty.

### **What is covered by the Limited Hardware Warranty**

ATEN will provide a repair service, without charge, during the Warranty Period. If a product is defective, ATEN will, at its discretion, have the option to (1) repair said product with new or repaired components, or (2) replace the entire product with an identical product or with a similar product which fulfills the same function as the defective product. Replaced products assume the warranty of the original product for the remaining period or a period of 90 days, whichever is longer. When the products or components are replaced, the replacing articles shall become customer property and the replaced articles shall become the property of ATEN.

To learn more about our warranty policies, please visit our website:  
<http://www.aten.com/global/en/legal/policies/warranty-policy/>