



# 16 x 16 Modular Matrix Switch

## VM1600A User Manual



# Preface

## EMC Information

---

### FEDERAL COMMUNICATIONS COMMISSION INTERFERENCE STATEMENT

This equipment has been tested and found to comply with the limits for a Class A digital device, pursuant to Part 15 of the FCC Rules. These limits are designed to provide reasonable protection against harmful interference when the equipment is operated in a commercial environment. This equipment generates, uses, and can radiate radio frequency energy and, if not installed and used in accordance with the instruction manual, may cause harmful interference to radio communications. Operation of this equipment in a residential area is likely to cause harmful interference in which case the user will be required to correct the interference at his own expense.

The device complies with Part 15 of the FCC Rules. Operation is subject to the following two conditions:

- (1) this device may not cause harmful interference, and
- (2) this device must accept any interference received, including interference that may cause undesired operation.

**FCC Caution:** Any changes or modifications not expressly approved by the party responsible for compliance could void the user's authority to operate this equipment.

**Warning:** Operation of the equipment in a residential environment could cause radio interference.

**Suggestion:** Shielded twisted pair (STP) cables must be used with the unit to ensure compliance with FCC & CE standards.

**KC Information:** 이 기기는 업무용(A급) 전자파 적합기기로서 판매자 또는 사용자는 이점을 주의하시기 바라며, 가정외의 지역에서 사용하는 것을 목적으로 합니다.

## RoHS

---

This product is RoHS compliant.

## User Information

### Online Registration

Be sure to register your product at our online support center:

International	<a href="http://eservice.aten.com">http://eservice.aten.com</a>
---------------	---

### Telephone Support

For telephone support, call this number:

International	886-2-8692-6959
China	86-10-82961301 or 86-10-82961302
Japan	81-3-5615-5811
Korea	82-2-467-6789
North America	1-888-999-ATEN ext 4988
United Kingdom	44-8-4481-58923

### User Notice

All information, documentation, and specifications contained in this manual are subject to change without prior notification by the manufacturer. The manufacturer makes no representations or warranties, either expressed or implied, with respect to the contents hereof and specifically disclaims any warranties as to merchantability or fitness for any particular purpose. Any of the manufacturer's software described in this manual is sold or licensed *as is*. Should the programs prove defective following their purchase, the buyer (and not the manufacturer, its distributor, or its dealer), assumes the entire cost of all necessary servicing, repair and any incidental or consequential damages resulting from any defect in the software.

The manufacturer of this system is not responsible for any radio and/or TV interference caused by unauthorized modifications to this device. It is the responsibility of the user to correct such interference.

The manufacturer is not responsible for any damage incurred in the operation of this system if the correct operational voltage setting was not selected prior to operation. PLEASE VERIFY THAT THE VOLTAGE SETTING IS CORRECT BEFORE USE.

## **Package Contents**

---

Check to make sure that all components are present and that nothing was damaged in shipping. If you encounter a problem, contact your dealer.

### **VM1600A**

The VM1600A package consists of:

- ◆ 1 VM1600A Modular Matrix Switch
- ◆ 1 Power Cord
- ◆ 1 Terminal Block connector
- ◆ 1 Fan Module (pluggable)
- ◆ 1 Power Module (pluggable)
- ◆ 1 User Instructions\*

### **VM7514 / VM8514**

The 4-Port HDBaseT Input / Output Board package consists of:

- ◆ 1 VM7514 4-Port HDBaseT Input Board / 1 VM8514 4-Port HDBaseT Output Board
- ◆ 4 Terminal Block connectors
- ◆ 1 IR Transmitter
- ◆ 1 IR Receiver
- ◆ 1 User Instructions\*

### **VM7814 / VM8814**

The 4-Port 4K HDMI Input / Output Board package consists of:

- ◆ 1 VM7814 4-Port 4K HDMI Input Board / 1 VM8814 4-Port 4K HDMI Output Board
- ◆ 4 Terminal Blocks
- ◆ 4 HDMI LockPro
- ◆ 1 User Instructions\*

### **VM7804 / VM8804**

The 4-Port HDMI Input / Output Board package consists of:

- ◆ 1 VM7804 4-Port HDMI Input Board / 1 VM8804 4-Port HDMI Output Board
- ◆ 4 Terminal Block connectors
- ◆ 1 User Instructions\*

### **VM7604 / VM8604**

The 4-Port DVI Input / Output Board package consists of:

- ◆ 1 VM7604 4-Port DVI Input Board / 1 VM8604 4-Port DVI Output Board
- ◆ 4 Terminal Block connectors
- ◆ 1 User Instructions\*

### **VM7104**

The 4-Port VGA Input Board package consists of:

- ◆ 1 VM7104 4-Port VGA Input Board
- ◆ 4 Terminal Block connectors
- ◆ 1 User Instructions\*

### **VM7404**

The 4-Port 3G-SDI Input Board package consists of:

- ◆ 1 VM7404 4-Port 3G-SDI Input Board
- ◆ 4 Terminal Block connectors
- ◆ 1 User Instructions\*

## **VE805R**

The HDMI HDBaseT Lite Receiver with Scaler package consists of:

- ◆ 1 VE805R HDMI HDBaseT Lite Receiver with Scaler
- ◆ 1 Power Adapter
- ◆ 1 Terminal Block connector
- ◆ 1 IR Transmitter
- ◆ 1 IR Receiver
- ◆ 1 User Instructions\*

## **VE816R**

The 4K HDMI HDBaseT Receiver with Scaler package consists of:

- ◆ 1 VE816R 4K HDMI HDBaseT Receiver with Scaler
- ◆ 1 Power Adapter
- ◆ 1 Terminal Block connector
- ◆ 1 IR Transmitter
- ◆ 1 IR Receiver
- ◆ 1 User Instructions\*

© Copyright 2018 ATEN® International Co., Ltd.  
Manual Date: 2018-04-02

ATEN and the ATEN logo are registered trademarks of ATEN International Co., Ltd. All rights reserved.  
All other brand names and trademarks are the registered property of their respective owners.

# Table of Contents

---

## Preface

EMC Information . . . . .	ii
RoHS . . . . .	ii
User Information . . . . .	iii
Package Contents . . . . .	iv
VM7514 / VM8514 . . . . .	iv
VM7814 / VM8814 . . . . .	iv
VM7804 / VM8804 . . . . .	v
VM7604 / VM8604 . . . . .	v
VM7104 . . . . .	v
VM7404 . . . . .	v
VE805R . . . . .	vi
VE816R . . . . .	vi
Table of Contents . . . . .	vii
About this Manual . . . . .	xi
Conventions . . . . .	xii
Product Information . . . . .	xii

## 1. Introduction

Overview . . . . .	1
Features . . . . .	4
VM7514 / VM8514 . . . . .	6
VM7814 / VM8814 . . . . .	7
VM7804 / VM8804 . . . . .	8
VM7604 / VM8604 . . . . .	9
VM7104 . . . . .	10
VM7404 . . . . .	10
VE805R . . . . .	11
VE816R . . . . .	12
Requirements . . . . .	13
Input / Output Board . . . . .	13
Source Devices . . . . .	13
Display Devices . . . . .	13
Cables . . . . .	14
Browsers . . . . .	15
Optional Equipment . . . . .	16
Components . . . . .	17
VM1600A Rear View . . . . .	19
VM7514 Front View . . . . .	21
VM7604 Front View . . . . .	23
VM7404 Front View . . . . .	24

## 2. Hardware Setup

Rack Mounting . . . . .	27
Mounting with Brackets . . . . .	28
Grounding . . . . .	29
Input / Output Board Installation . . . . .	30
Cable Connection . . . . .	32

## 3. Front Panel Operation

Overview . . . . .	35
Front Panel Pushbuttons . . . . .	35
Basic Navigation . . . . .	35
Front Panel LCD . . . . .	36
LCD Password . . . . .	36
Port Switching . . . . .	37
Video / Audio Pushbutton . . . . .	37
Input Port Selection . . . . .	38
Output Port Selection . . . . .	40
Profile Pushbutton . . . . .	42
LCD Menu . . . . .	43
LCD Main Screen . . . . .	44
IP Setting . . . . .	45
Serial Port Setting . . . . .	46
Serial Port Address Setting . . . . .	46
Baud Rate . . . . .	47
Serial Port Mode . . . . .	47
Operation Mode . . . . .	49
EDID . . . . .	49
CEC . . . . .	51
OSD . . . . .	52
Output Status . . . . .	53
Security Mode . . . . .	55
Mode . . . . .	55
Change Password . . . . .	56
Save to a Profile . . . . .	58
Play/Stop the Profile Schedule . . . . .	59
Turn Video Wall Off . . . . .	59

## 4. Browser Operation

Overview . . . . .	61
Logging In . . . . .	61
Main Page . . . . .	62
Menu Bar . . . . .	63
Setting the Standby Mode . . . . .	63
Profile List . . . . .	64
Creating a Profile . . . . .	65



---

Editing a Profile	67
Profile Layout Settings	68
Display Preferences	69
Grid View	70
Video Wall Settings	71
Audio Output Settings	76
Playing a Profile	77
Importing/Exporting a Profile	79
Profile Scheduling	80
Enabling/Disabling Profile Scheduling	80
Configuring Profile Schedules	81
System Settings	83
General	85
Serial Settings	86
Fan Status	86
Power Status	86
Device Info	86
System Time	87
Other	87
User Account	88
Add Account	89
Permission Level	90
Port Name	91
Network	92
EDID Settings	93
EDID Mode	94
EDID & CEA Description	95
Customized Mode	96
Customized EDID Parameters	97
CEA Settings	100
Video Data	101
Maintenance	103
VE805R / VE816R Firmware Upgrade	103
IR/RS-232 Channel	105
Video	107
HDCP	109
OSD/CEC	110
Telnet Operation	111
Configuration Menu	111
1. H – Call up the command list for help	111
2. IP – Set IP address	112
3. LO – Load connections from profile	112
4. PW – Change password	112
5. RI – Read what input is connected to nn output	112
6. RO – Read what output is connected to nn input	112
7. SB – Set serial port baud rate	112

---

8. SS – Switch input to specified output . . . . .	112
9. SV – Save the current connections into a profile . . . . .	112
10. TI – Set timeout . . . . .	113
11. VR – Software version information . . . . .	113

## 5. RS-232 Commands

Serial Control Protocol Commands . . . . .	115
RS-232 Pin Assignment . . . . .	115
Configuring the Serial Port . . . . .	115
Switch Port Command . . . . .	117
Mute Command . . . . .	120
Volume Command . . . . .	122
Save/Load Profile Commands . . . . .	124
EDID Mode Command . . . . .	126
CEC Command . . . . .	128
Read Command . . . . .	129
Reset Command . . . . .	131
Baud Rate Command . . . . .	132
OSD Command . . . . .	133
Echo Command . . . . .	134
Scaling Command . . . . .	135
Fan Speed Command . . . . .	139
Alert Command . . . . .	140
FrameSync Command . . . . .	141
Long Reach Mode Command . . . . .	142

## Appendix

Safety Instructions . . . . .	143
Rack Mounting . . . . .	145
Technical Support . . . . .	146
Specifications . . . . .	147
VM7514 / VM8514 . . . . .	149
VM7814 / VM8814 . . . . .	150
VM7804 / VM8804 . . . . .	151
VM7604 / VM8604 . . . . .	152
VM7104 . . . . .	153
VM7404 . . . . .	154
VE805R . . . . .	155
VE816R . . . . .	156
VM-PWR460 . . . . .	157
VM-FAN554 . . . . .	157
Limited Warranty . . . . .	158

## About this Manual

This User Manual is provided to help you get the most from your VM1600A Modular Matrix Solution system, which includes the following the following product models:

Device Type	Model	Product Name
Modular Matrix Switch	VM1600A	32 x 32 Modular Matrix Switch
Input / Output Board	VM7514 / VM8514	4-Port HDBaseT Input / Output Board
	VM7814 / VM8814	4-Port 4K HDMI Input / Output Board
	VM7804 / VM8804	4-Port HDMI Input / Output Board
	VM7604 / VM8604	4-Port DVI Input / Output Board
	VM7104	4-Port VGA Input Board
	VM7404	4-Port 3G-SDI Input Board
Video Receiver	VE805R	HDMI HDBaseT Lite Receiver with Scaler
	VE816R	4K HDMI HDBaseT Receiver with Scaler

This manual covers all aspects of installation, configuration and operation. An overview of the information found in the manual is provided below.

**Chapter 1, Introduction,** introduces you to the Modular Matrix Solution system and its components. Its purpose, features, and benefits are presented, and its front and back panel components are described.

**Chapter 2, Hardware Setup,** describes how to set up the hardware for your Modular Matrix Solution installation.

**Chapter 3, Front Panel Operation,** explains the fundamental concepts involved in operating the VM1600A at the local site via the front panel LCD display using pushbuttons.

**Chapter 4, Browser Operation,** provides a complete description of the Modular Matrix Solution's web Graphical User Interface (GUI), and how to use it to remotely configure and operate the Modular Matrix Solution.

**Chapter 5, RS-232 Commands,** provides a complete list of the serial control protocol commands used when utilizing the RS-232 Serial Port so that an extra source device can be utilized in the installation.

**An Appendix,** which provides specifications and other technical information regarding the Modular Matrix Solution.

## Conventions

---

This manual uses the following conventions:

- `Monospaced` Indicates text that you should key in.
- [ ] Indicates keys you should press. For example, [Enter] means to press the **Enter** key. If keys need to be chorded, they appear together in the same bracket with a plus sign between them: [Ctrl+Alt].
  - 1. Numbered lists represent procedures with sequential steps.
  - ◆ Bullet lists provide information, but do not involve sequential steps.
  - Indicates selecting the option (on a menu or dialog box, for example), that comes next. For example, Start → Run means to open the *Start* menu, and then select *Run*.
  -  Indicates critical information.

## Product Information

---

For information about all ATEN products and how they can help you connect without limits, visit ATEN on the Web or contact an ATEN Authorized Reseller. Visit ATEN on the Web for a list of locations and telephone numbers:

International	<a href="http://www.aten.com">http://www.aten.com</a>
North America	<a href="http://www.aten-usa.com">http://www.aten-usa.com</a>

# Chapter 1

## Introduction

### Overview

---

This ATEN Modular Matrix Solution Series is comprised of the VM1600A Modular Matrix Switch, input boards, output boards, and ATEN video receiver (VE805R / VE816R).

The VM1600A Modular Matrix Switch offers advanced access and real-time control of multiple local and remote A/V input devices and displays from a single chassis. Operators can work from 4 x 4 up to 16 x 16 inputs and outputs simultaneously, as well as incorporate multiple digital video formats within the setup. It uses TMDS technology to support high speed data transfer at 1080p / 1920 x 1200 @ 60Hz.

The VM7514 / VM8514 4-Port HDBaseT Input/Output Boards offers an easy way to route any of 4 HDBaseT audio/video sources to any of 4 HDBaseT display devices, in combination with the ATEN Modular Matrix Switch. When the VM8514 HDBaseT Output Board is used in conjunction with the VE805R / VE816R HDBaseT Extender, it features Seamless Switch™ technology and video wall functionality.

The VM7814 / VM8814 is a 4-Port 4K HDMI input/output board that works with VM1600A to route 4 HDMI sources to 4 displays. The VM7814 / VM8814 is equipped with 4 input/output ports to allow for stereo audio embedding and audio extraction. The VM8814 supports Seamless Switch™ to ensure real-time video switching, a built-in 4K scaler to handle videos of different resolutions, and EDID Expert™ to ensure high video quality.

The VM7804 / VM8804 4-Port HDMI Input / Output Board is a hot-swappable I/O board that offers an easy way to route any of 4 audio/video sources to any of 4 displays and installs in the Modular Matrix Switch. The VM8804 supports Seamless Switch™ technology that provides video switching in real-time, a built in scaler that handles different video resolutions, and EDID Expert technology for fast smooth switching between displays. The VM7804 / VM8804 also supports separate stereo audio signals that can be routed independently and extracted from embedded HDMI audio signals.

The VM7604 / VM8604 4-Port DVI Input / Output Board is a hot-swappable I/O board that offers an easy way to route any of 4 audio/video sources to any of 4 displays and installs in the Modular Matrix Switch. The VM8604 supports Seamless Switch™ technology that provides video switching in real-time, a built in scaler that handles different video resolutions and EDID Expert technology for fast smooth switching between displays.

The VM7104 4-Port VGA Input Board offers an easy way to route 4 VGA video and audio sources to 4 displays and speakers. In addition, the VM7104 can be mixed with any modular output boards on the VM1600A for optimum flexibility.

The VM7404 is a 4-Port 3G-SDI input board provides the capability to connect to SDI sources, such as 3G-SDI, HD-SDI and SD-SDI, and supports high quality video resolutions up to 1080p @ 60Hz. The VM7404 also supports separate analog stereo audio signals for independent routing.

The VE805R HDMI HDBaseT Lite Receiver with Scaler or VE816R 4K HDMI HDBaseT Receiver with Scaler can be combined with an ATEN HDMI HDBaseT transmitter or splitter to extend your HDMI display up to 70 m from the source using a single Cat 6a cable (or up to 60 m when using a single Cat 5e cable). With a built-in scaler, the VE805R / VE816R supports the scaling of different video resolutions. When combined with ATEN HDBaseT output boards, it supports video wall functionality. In addition, the VE805R / VE816R is equipped with RS-232 and IR signaling pass-through which allows RS-232 and IR channel control from the remote to local unit, to control the HDMI source, or from the local to remote unit, to control the display device. The VE805R / VE816R is HDCP compliant.

Combining these devices, this solution can be conveniently customized, allowing users to independently switch and route video and/or audio signals to various monitors, displays, projectors and/or speakers simply by pressing front panel pushbuttons. The VM1600A's built-in Scaler encodes video formats in order to provide seamless, real-time switching while ensuring stable signal transmission. In addition, the front panel LCD shows a quick view of active port connections, and includes an option to select an EDID Mode that yields the best resolution across different monitors.

The VM1600A is easily expandable and accommodates ATEN's hot-swappable I/O boards. Equipped with automatic signal conversion, it allows a

combination of digital video formats, thus making it ideal for large-scale A/V applications.

Setup is fast and easy; install the modular I/O boards by sliding them into the VM1600A's rear panel slots, then plug the device cables into the appropriate ports on the I/O boards and you're ready.

This solution can be connected to the network through the VM1600A's LAN port, allowing the installation to take advantage of internal Cat 5 Ethernet wiring built into most modern commercial buildings. Once initial network setup has been accomplished at the local level, the VM1600A can be conveniently managed remotely using any web browser. Furthermore, for complete systems integration, the VM1600A's built-in RS-232 and RS-485/RS-422 ports allow the switch to be configured through a high-end controller or PC.

The ATEN Modular Matrix Solution Series is a powerful integrated A/V setup targeted towards broadcasting stations, traffic and transportation-related control rooms, emergency service centers and any application that requires customizable high speed A/V signal routing.

## Features

---

### **VM1600A**

- ◆ 16 x 16 I/O connections via 4 x4 I/O slots for modular matrix boards
- ◆ Multiple control methods – system management via front-panel pushbuttons, RS-232/RS-422/RS-485, and Ethernet connections for web GUI or Telnet
- ◆ 4K resolutions – up to UHD (3810 x 2160) and DCI (4096 x 2160) with refresh rates of 30 Hz (4:4:4) and 60 Hz (4:2:0)\*
- ◆ Scaler – features a video scaling function to convert input resolutions to the optimum display resolutions\*
- ◆ Seamless Switch™ – features close-to-zero second switching that provides continuous video streams, real-time switching, and stable signal transmissions\*
- ◆ Video wall – allows you to create custom video wall layouts via intuitive web GUI\*
- ◆ Profile scheduling – plays connection profiles based on user-defined schedules
- ◆ EDID Expert™ – selects optimum EDID settings for smooth power-up, high-quality display and use of the best resolution across different screens
- ◆ Audio-enabled – HDMI audio can be extracted and stereo audio can be embedded\*
- ◆ Bi-directional RS-232 channel – allows you to control connected serial devices through the web GUI
- ◆ Supports redundant power module for higher reliability
- ◆ Hot-pluggable design for easy integration of I/O boards, fan module, and power supplies
- ◆ HDCP 2.2 Compatible\*
- ◆ HDMI: 3D, Deep Color, 4K\*
- ◆ Consumer Electronics Control (CEC) supported\*
- ◆ Rack mountable (6U design)



**Note:**

- ◆ Features marked with an asterisk (\*) are supported only with specific I/O boards. For more information, see the feature descriptions for I/O boards in this manual.
  - ◆ The maximal output resolution, and the Scaler, Seamless Switch™ and video wall features are only supported with certain I/O boards. For more details, refer to the specifications of the particular I/O boards in this manual.
  - ◆ When Seamless Switch™ or Video Wall is enabled, videos may not display within range, in which case make sure to adjust the display settings on your device.
  - ◆ Video outputs will not display 3D, Deep Color, or interlace (i.e., 1080i) resolutions correctly if Seamless Switch™ is enabled. To use these features, make sure to first disable Seamless Switch™.
-

## **VM7514 / VM8514**

- ◆ Compatible with the VM1600A; mix and match with modular I/O boards of any type for optimum flexibility
- ◆ Superior video quality up to 4K when used with VE816R
- ◆ Long-distance transmission up to 100 m
- ◆ Bi-directional RS-232 channel transmits signals over Cat 6/6a cable to control a display or other devices
- ◆ HDBaseT Connectivity – extends 4 HDBaseT connections over a long distance via a single Cat 6/6a cable or ATEN 2L-2910 Cat 6 cable
- ◆ HDBaseT Anti-jamming – resists signal interference during high-quality video transmissions using HDBaseT technology
- ◆ Seamless Switch™ – features close-to-zero second switching that provides continuous video streams, real-time switching, and stable signal transmissions (VM8514 only)\*
- ◆ Video wall – allows you to create custom video wall layouts via intuitive web GUI (VM8514 only)\*
- ◆ Bi-directional IR channel – full range IR transmission (30 ~ 56 kHz) is processed one direction at a time

---

### **Note:**

- ◆ The Seamless Switch™ and video wall functions are only available when used with the VE805R and VE816R.
  - ◆ When Seamless Switch™ or Video Wall is enabled, videos may not display within range, in which case make sure to adjust the display settings on your device.
  - ◆ Video outputs will not display 3D, Deep Color, or interlace (i.e., 1080i) resolutions correctly if Seamless Switch™ is enabled. To use these features, make sure to first disable Seamless Switch™.
-

**VM7814 / VM8814**

- ◆ Compatible with the VM1600A; mix and match with modular I/O boards of any type for optimum flexibility
- ◆ Superior video quality – HDTV resolutions of 480p, 720p, 1080i, and 1080p (1920 x 1080); 4K2K @ 60Hz (4:2:0)
- ◆ Audio-enabled, HDMI audio can be extracted and stereo audio can be embedded
- ◆ Scaler – features a 4K video scaling function to convert input resolutions to the optimum display resolutions\* (VM8814 only)
- ◆ Seamless Switch™ – features close-to-zero-second switching to provide continuous video streams, real-time switching, and stable signal transmissions\* (VM8814 only)
- ◆ Video Wall – allows you to create custom video wall layouts via intuitive web GUI (VM8814 only)
- ◆ HDMI (3D, Deep Color)\*; HDCP 2.2 Compatible
- ◆ Cable Quality Tester – examines the HDMI cable quality
- ◆ Consumer Electronics Control (CEC) support
- ◆ EDID Expert™ – selects optimum EDID settings for smooth power-up and highest quality display
- ◆ FrameSync – prevents image tearing by synchronizing the scaler output frame rate to the input signal frame rate (VM8814 only)

---

**Note:**

- ◆ When Seamless Switch™ or Video Wall is enabled, videos may not display within range, in which case make sure to adjust the display settings on your device.
  - ◆ When Seamless Switch™ is enabled, video outputs will not display 3D, Deep Color, or interlace (i.e., 1080i) resolutions correctly.
-

## **VM7804 / VM8804**

- ◆ Compatible with the VM1600A; mix and match with modular I/O boards of any type for optimum flexibility
- ◆ Superior video quality – HDTV resolutions of 480p, 720p, 1080i (1920 x 1080), and 1080p (1920 x 1080)
- ◆ Audio-enabled, HDMI audio can be extracted and stereo audio can be embedded
- ◆ Scaler – features a video scaling function to convert input resolutions to the optimum display resolutions\* (VM8804 only)
- ◆ Seamless Switch™ – features close-to-zero-second switching to provide continuous video streams, real-time switching, and stable signal transmissions\* (VM8804 only)
- ◆ Video Wall – allows you to create custom video wall layouts via intuitive web GUI (VM8804 only)
- ◆ HDMI (3D, Deep Color); HDCP 1.4 Compatible
- ◆ Consumer Electronics Control (CEC) support
- ◆ EDID Expert™ – selects optimum EDID settings for smooth power-up and highest quality display

---

### **Note:**

- ◆ When Seamless Switch™ or Video Wall is enabled, videos may not display within range, in which case make sure to adjust the display settings on your device.
  - ◆ When Seamless Switch™ is enabled, video outputs will not display 3D, Deep Color, or interlace (i.e., 1080i) resolutions correctly. To use these features, make sure to first disable Seamless Switch™.
-

**VM7604 / VM8604**

- ◆ Compatible with the VM1600A; mix and match with modular I/O boards of any type for optimum flexibility
- ◆ Scaler – features a video scaling function to convert input resolutions to the optimum display resolutions\* (VM8604 only)
- ◆ Seamless Switch™ – features close-to-zero-second switching to provide continuous video streams, real-time switching, and stable signal transmissions\* (VM8604 only)
- ◆ Video Wall – allows you to create custom video wall layouts via intuitive web GUI (VM8604 only)
- ◆ HDCP 1.4 Compatible
- ◆ EDID Expert™ – selects optimum EDID settings for smooth power-up and highest quality display
- ◆ Built-in EDID wizard – provides an easy way to customized EDID settings
- ◆ Audio-enabled, HDMI audio (VM7804 / VM7814) can be extracted to VM8604; VM7604's stereo audio can be embedded to HDMI audio (VM8804 / VM8814)

---

**Note:**

- ◆ When Seamless Switch™ or Video Wall is enabled, videos may not display within range, in which case make sure to adjust the display settings on your device.
  - ◆ When Seamless Switch™ is enabled, video outputs will not display 3D, Deep Color, or interlace (i.e., 1080i) resolutions correctly. To use these features, make sure to first disable Seamless Switch™.
-

## **VM7104**

- ◆ Connects up to 4 VGA or Component inputs
- ◆ Compatible with the VM1600A; mix and match with modular I/O boards of any type for optimum flexibility
- ◆ Supports RGBHV / RGBS / YPbPr / YCbCr input signals
- ◆ Audio-enabled, stereo audio can be embedded into HDMI audio (VM8804 / VM8814)

---

**Note:** When the VM7104 is used with the VM8514+VE805R/VE816R, VM8804, VM8814, or VM8604, the Seamless Switch™, scaler, and video wall functions can be activated.

---

## **VM7404**

- ◆ Connects up to 4 SDI inputs
- ◆ Compatible with the VM1600A; mix and match with modular I/O boards of any type for optimum flexibility
- ◆ Support SD-SDI, HD-SDI, and 3G-SDI formats
- ◆ Audio-enabled, stereo audio can be embedded into HDMI audio (VM8804 / VM8814)

---

**Note:** When the VM7404 is used with the VM8514+VE805R/VE816R, VM8804, VM8814, or VM8604, the Seamless Switch™, scaler, and video wall functions can be activated.

---

**VE805R**

- ◆ Extends HDMI, RS-232, and IR signals up to 70 m over a single Cat 5e/6/6a cable
- ◆ HDMI (3D, Deep Color); HDCP 1.4 compliant
- ◆ Superior video quality – 1080p@60m (Cat 5e/6); 70m (Cat 6a)
- ◆ Scaler – scales videos of different resolutions to their optimal output for display and to avoid black screen\*
- ◆ Video Wall – features video wall profiles that allows for custom screen layouts via an intuitive web GUI\*
- ◆ Seamless Switch™ – close-to-zero second switching that provides continuous video streams, real-time switching, and stable signal transmissions\*
- ◆ HDBaseT Anti-jamming – resists signal interference during high-quality video transmissions using HDBaseT technology
- ◆ Bi-directional RS-232 channel – allows for control using serial terminals or serial devices, such as touch screens and barcode scanners
- ◆ Bi-directional IR channel – IR transmission is processed one direction at a time\*
- ◆ Firmware upgradeable
- ◆ Built- in 8KV / 15 KV ESD protection
- ◆ Plug-and-play
- ◆ Rack-mountable

---

**Note:**

- ◆ The Seamless Switch™ and the video wall functions are only available when the VE805R is used with the ATEN HDBaseT I/O boards.
  - ◆ When Seamless Switch™ or Video Wall is enabled, videos may not display within range, in which case make sure to adjust the display settings on your device.
  - ◆ When Seamless Switch™ is enabled, video outputs will not display 3D, Deep Color, or interlace (i.e., 1080i) resolutions correctly. To use these features, make sure to first disable Seamless Switch™.
  - ◆ The VE805R supports full-frequency IR signals from 30 kHz to 56 kHz.
-

## **VE816R**

- ◆ Extends HDMI, RS-232, and IR signals up to 100 m over a single Cat 5e/6/6a or ATEN 2L-2910 Cat 6 cable
- ◆ HDCP 2.2 compatible
- ◆ Superior video quality (4K up to 100m; 1080p up to 150m)
- ◆ HDBaseT Long Reach Mode – activated by RS-232 commands, Long Reach Mode extends signals up to 150 m, 1080p, via a single Cat 5e/6 cable
- ◆ Scaler – scales videos of different resolutions to their optimal output for display and to avoid black screen
- ◆ Video Wall – features video wall profiles that allows for custom screen layouts via an intuitive web GUI\*
- ◆ Seamless Switch™ – close-to-zero second switching that provides continuous video streams, real-time switching, and stable signal transmissions\*
- ◆ HDBaseT Anti-jamming – resists signal interference during high-quality video transmissions using HDBaseT technology
- ◆ Bi-directional RS-232 channel – allows for control using serial terminals or serial devices, such as touch screens and barcode scanners
- ◆ Bi-directional IR channel – IR transmission is processed one direction at a time\*
- ◆ Cable Quality Tester – examines the category cable quality through signal level detection from HDBaseT Matrix Switches to the VE816R.
- ◆ FrameSync – prevents image tearing by synchronizing the scaler output frame rate to the input signal frame rate
- ◆ Remote Firmware upgrade
- ◆ Built- in 8KV / 15 KV ESD protection
- ◆ Plug-and-play
- ◆ Rack-mountable

---

### **Note:**

- ◆ The Seamless Switch™ and the video wall functions are only available when the VE816R is used with ATEN HDBaseT I/O boards.
  - ◆ When Seamless Switch™ or Video Wall is enabled, videos may not display within range, in which case make sure to adjust the display settings on your device.
  - ◆ When Seamless Switch™ is enabled, video outputs will not display 3D, Deep Color, or interlace (i.e., 1080i) resolutions correctly. To use these features, make sure to first disable Seamless Switch™.
  - ◆ The VE816R supports full-frequency IR signals from 30 kHz to 56 kHz.
-



## Requirements

---

The following are required for a complete VM1600A Modular Matrix Solution Series installation:

### **Input / Output Board**

- ◆ VM7514 (HDBaseT input board) and VM8514 (HDBaseT output board)
- ◆ VM7814 (4K HDMI input board) and VM8814 (4K HDMI output board)

---

**Note:** The VM7814 / VM8814 are only supported by the VM1600A using firmware version 3.0.298 or later.

---

- ◆ VM7804 (HDMI input board) and VM8804 (HDMI output board)
- ◆ VM7604 (DVI input board) and VM8604 (DVI output board)
- ◆ VM7104 (VGA input board)
- ◆ VM7404 (3G-SDI input board)

### **Source Devices**

- ◆ For VM7514 4-port HDBaseT input board + VE802T HDBaseT Transmitter: Digital A/V source device with HDMI output connector(s)
- ◆ For VM7814 4-port 4K HDMI input board: Digital A/V source device with HDMI output connector(s)
- ◆ For VM7804 4-port HDMI input board: Digital A/V source device with HDMI output connector(s)
- ◆ For VM7604 4-Port DVI input board: Digital A/V source device with DVI output connector(s)
- ◆ For VM7104 4-Port VGA input board: A/V source device with VGA output connector(s)
- ◆ For VM7404 4-Port 3G-SDI Input Board: SDI sources, including 3G-SDI, HD-SDI and SD-SDI

### **Display Devices**

- ◆ For VM8514 4-port HDBaseT output board + VE805R/VE816R HDBaseT Receiver: Digital Display device(s) with HDMI input connector(s)

---

**Note:** The VE816R is only supported by the VM8514 using firmware version 2.1.206 or later.

---

- ◆ For VM8814 4-port 4K HDMI output board: Digital Display device(s) with HDMI input connector(s)
- ◆ For VM8804 4-port HDMI output board: Digital Display device(s) with HDMI input connector(s)
- ◆ For VM8604 4-Port DVI output board: Digital Display device(s) with DVI input connector(s)

## **Cables**

- ◆ 1 SDI cable for each source device (VM7404)
- ◆ 1 Cat 5e cable for each transmitter (VM7514)
- ◆ 1 Cat 5e cable for each receiver (VM8514)
- ◆ 1 HDMI cable for each source device (VM7814 / VM7804)
- ◆ 1 HDMI cable for each display device (VM8814 / VM8804)
- ◆ 1 DVI cable for each source device (VM7604)
- ◆ 1 DVI cable for each display device (VM8604)
- ◆ 1 VGA cable for each source device (VM7104)
- ◆ 1 HDMI cable for each display device (VE805R / VE816R)
- ◆ 1 audio cable for each audio source device (VM7814 / VM7804 / VM7604)
- ◆ 1 audio cable for each audio device / speaker (VM8814 / VM8804 / VM8604)
- ◆ 1 Ethernet cable (VM1600A)
- ◆ 1 RS-232 serial cable (VM1600A / VM7514 / VM8514 / VE805R / VE816R)
- ◆ 1 RS-485/RS-422 serial cable (VM1600A)
- ◆ 1 IR cable for each IR transmitter device (VM7514 or VM8514)
- ◆ 1 IR cable for each IR receiver device (VM7514 or VM8514)

---

**Note:** No cables are included in this package. We strongly recommend that you purchase high-quality cables of appropriate length since this will affect the quality of the audio and video display. Contact your dealer to purchase the correct cable sets.

---

## **Browsers**

Supported web browsers are shown in the table below:

<b>OS</b>	<b>Java Version</b>	<b>Browser</b>	<b>Version</b>
Windows 8.1	V1.8.0_60	Chrome	45.0.2454.85 m
		Firefox	40.0.3
		Safari	5.1.7
		Opera	31.0.1889.174
		IE11	11
Windows 2012 R2 (64bit)	V1.8.0_60 (64bit)	IE11	11 (64bit)
Windows 2008 R2 (64bit)	V1.8.0_60 (64bit)	IE8	8
Windows 7 SP1(64bit)	V1.8.0_60 (64bit)	IE10	10 (64bit)
Windows XP	V1.8.0_60	IE8	8
CentOS 7.0 (64Bit)	V1.8.0_60 (64bit)	Firefox	40.0.3
Ubuntu 12.04	V1.8.0_60	Chrome	45.0.2454.85
Solaris 11(64bit)	V1.8.0_25	Firefox	33
Mac 10.10	V1.8.0_25	Safari	8

## **Optional Equipment**

Depending on any optional equipment that you may have purchased, one of the following may be included in your package. Contact your ATEN dealer to purchase any of these additional accessories.

<b>Model No.</b>	<b>Description</b>	<b>Dimensions (L x W x H)</b>	<b>Weight</b>
2X-026G	Easy Installation Rack Mount Kit - Short	42-70 cm (depth)	-
2X-027G	Easy Installation Rack Mount Kit - Long	68-105 cm (depth)	-
2X-030G (Left)	Video Wall TV Mounting Brackets	15.47 x 11.83 x 43.00 cm	2.00 kg
2X-030G (Right)	Video Wall TV Mounting Brackets	15.47 x 12.80 x 43.00 cm	2.00 kg
2X-RC1600	Video Wall TV Stand	140.00 x 90.00 x 207.00 cm	60.00 kg
VM-PWR460	Video Matrix Power Module	-	-
VM-FAN554	Video Matrix Fan Module	-	-

## Components

### VM1600A Front View

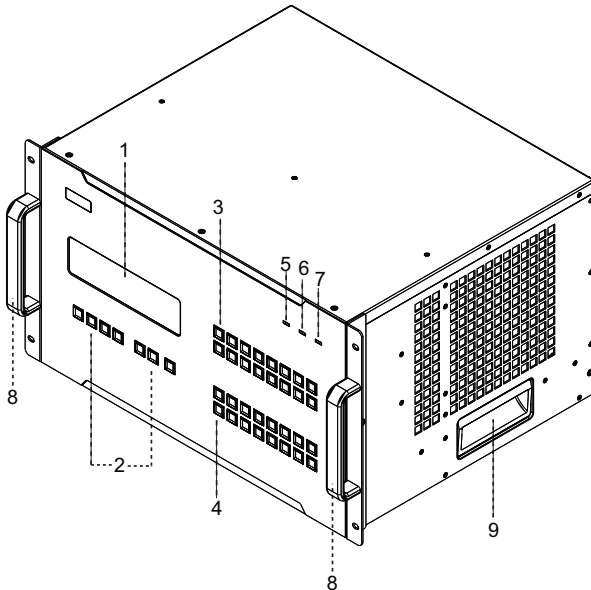

No.	Component	Description
1	LCD Display	The LCD Display shows the options for configuring and operating the VM1600A. See <i>Front Panel Pushbuttons</i> , page 35, for details.
2	Function Pushbuttons	Use the UP, DOWN and CANCEL buttons to navigate the LCD display to configure the installation. Press the Video, Audio, Menu and Profile buttons to use each function. See <i>Front Panel Pushbuttons</i> , page 35, for details. <b>Note:</b> The pushbuttons have LEDs that light to indicate they have been selected.
3	Input Pushbuttons (1-16)	These pushbuttons refer to the Input ports on the VM1600A rear panel. Press to select the Input port. These pushbuttons may also correspond to menu options, profiles and other selections.
4	Output Pushbuttons (1-16)	These pushbuttons refer to the Output ports on the VM1600A rear panel. Press to select the Output port.
5	Alarm LED	The Alarm LED lights red to indicate the power or fan module has failed.

<b>No.</b>	<b>Component</b>	<b>Description</b>
6	Redundant Power LED	This LED lights green to indicate the redundant power module is plugged in and working.
7	Primary Power LED	This LED lights green to indicate the primary power module is plugged in and working.
8	Handles	The two front handles are used to install the unit into a rack.
9	Recessed Handles	The two side handles are used to transport the unit.

## VM1600A Rear View

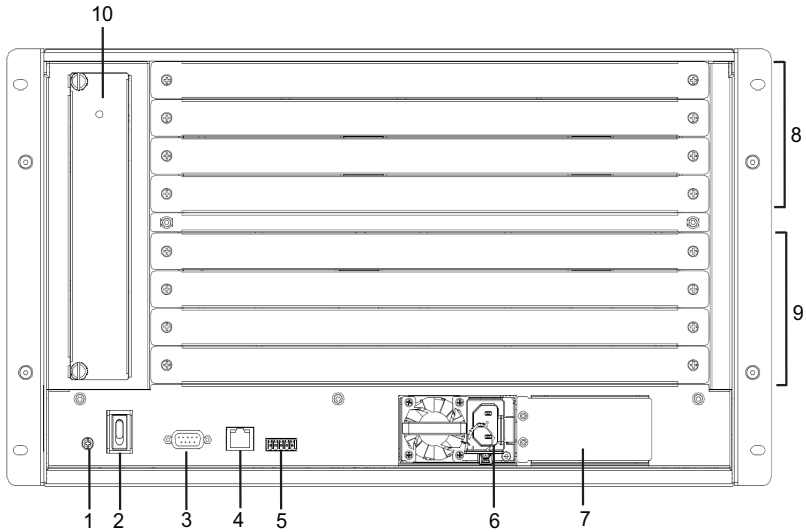

No.	Component	Description
1	Grounding Terminal	The grounding wire attaches here. See <i>Grounding</i> , page 29, for further details.
2	Power Switch	This is a standard rocker switch that powers the unit on and off.
3	RS-232 Serial Port	Connect a computer or high-end system controller via this serial port.
4	Ethernet Port	In order to access the VM1600A's web Graphical User Interface (GUI), the VM1600A must be connected to the network. The cable that connects the VM1600A to your LAN plugs in here. See <i>Cable Connection</i> , page 32, for further details
5	RS-485 / RS-422 Serial Port	Connect a computer or high-end system controller via this serial port.
6	Primary Power Supply	This is a standard 3-pin power socket. The power cord from a source plugs in here.
7	Redundant Power Slot (Optional)	This slot with protective cover is used to install an additional power supply for redundant power protection.  <b>Note:</b> The extra power module is not included in the VM1600A package. See <i>Optional Equipment</i> , page 16, for details.

No.	Component	Description
8	Input Board Slots	Unscrew the cover to insert the Input boards into these 4 horizontal slots. The source devices connect to the inserted Input boards.
9	Output Board slots	Unscrew the cover to insert the output boards into these 4 horizontal slots. The display devices connect to the inserted Output boards.
10	Fan Module	This slot contains the fan module. The fan is hot-pluggable and the panel unscrews to install a replacement module. For more information, see <i>Optional Equipment</i> , page 16.



## VM7514 Front View

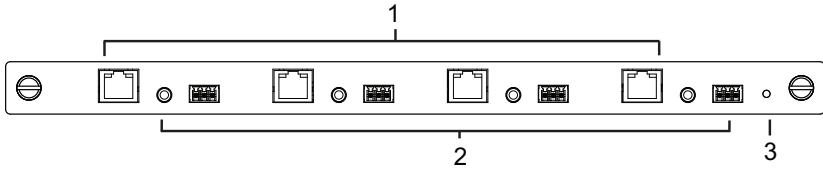

No.	Component	Description
1	HDBaseT Input Ports	Connect the Cat 5e cables from your HDBaseT transmitter to these ports.
2	IR / RS-232 Input Ports	Connect the cables from your IR transmitter to the mini stereo jack ports, and connect the cables from your RS-232 device to the RS-232 ports.
3	Status LED	The VM7514 has an LED to indicate the working status.

## VM8514 Front View

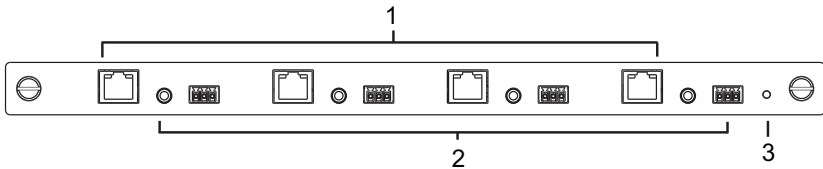

No.	Component	Description
1	HDBaseT Output Ports	Connect the Cat 5e cables from your HDBaseT receiver to these ports.
2	IR / RS-232 Output Ports	Connect the cables from your IR receiver to the mini stereo jack ports, and connect the cables from your RS-232 device to the RS-232 ports.
3	Status LED	The VM8514 has an LED to indicate the working status.

## **VM7814 / VM7804 Front View**

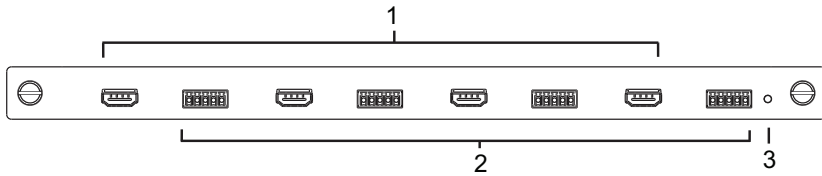

No.	Component	Description
1	HDMI Input Ports	Connect the cables from your HDMI video source devices to these ports.
2	Audio Input Ports	Connect the cables from your audio source devices to these ports.
3	Status LED	The VM7814 / VM7804 has an LED to indicate the working status.

## **VM8814 / VM8804 Front View**

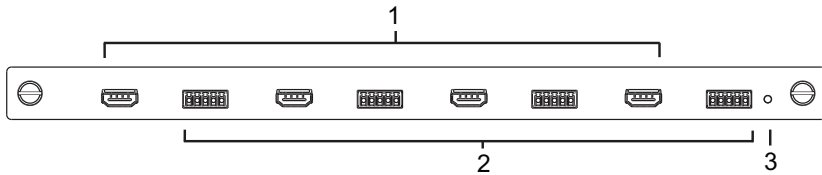

No.	Component	Description
1	HDMI Output Ports	Connect the cables from your HDMI display devices (monitors, projectors, TVs) to these ports.
2	Audio Output Ports	Connect the cables from your output audio devices or speakers to these ports.
3	Status LED	The VM8814 / VM8804 has an LED to indicate the working status.

## VM7604 Front View

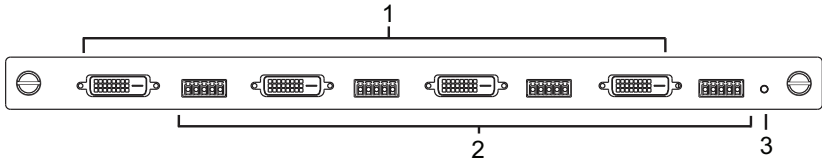

No.	Component	Description
1	DVI Input Ports	Connect the cables from your video source devices to these ports.
2	Audio Input Ports	Connect the cables from your audio source devices to these ports.
3	Status LED	The VM7604 has an LED to indicate the working status.

## VM8604 Front View

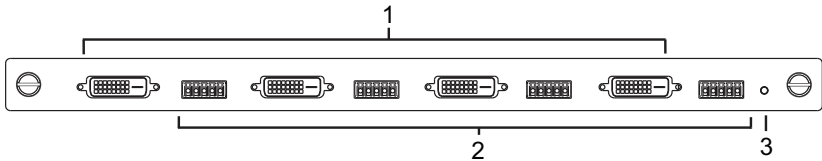

No.	Component	Description
1	DVI Output Ports	Connect the cables from display devices (monitors, projectors, TVs) to these ports.
2	Audio Output Ports	Connect the cables from your output audio devices or speakers to these ports.
3	Status LED	The VM8604 has an LED to indicate the working status.

## **VM7104 Front View**

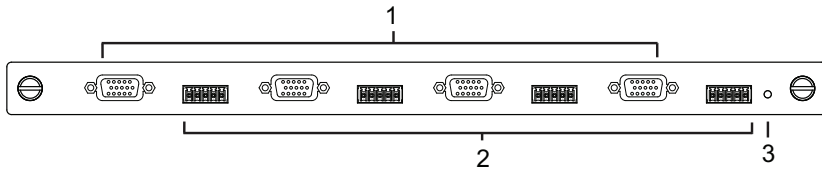

No.	Component	Description
1	VGA Input Ports	Connect the cables from your VGA video source devices to these ports.
2	Audio Input Ports	Connect the cables from your audio source devices to these ports.
3	Status LED	The VM7104 has an LED to indicate the working status.

## **VM7404 Front View**

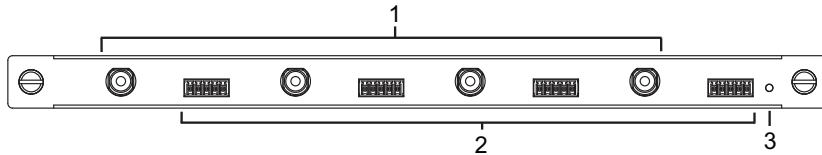

No.	Component	Description
1	SDI Input Ports	Connect the cables from your video source devices to these ports.
2	Analog Stereo Audio Input Ports	Connect the cables from your audio source devices to these ports.
3	Status LED	The VM7404 has an LED to indicate the working status.

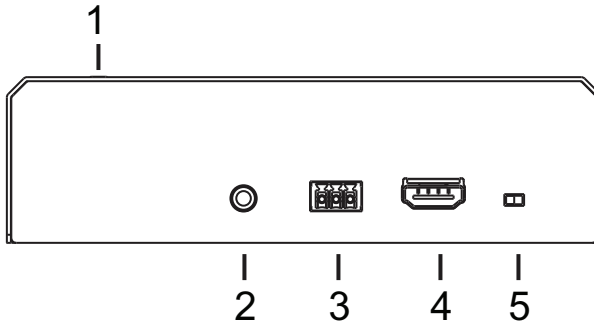
**VE805R / VE816R Front View****VE805R / VE816R Rear View**

No.	Component	Description
1	LEDs	<p>Three LEDs – Power, Link and HDMI Out – light when the unit is properly connected to an appropriate source.</p> <ul style="list-style-type: none"> <li>◆ Power - lights Green to indicate the unit is receiving power.</li> <li>◆ Link - lights Orange to indicate that communication between VE805R / VE816R and output board is established.</li> <li>◆ HDMI Out - lights Orange to indicate the HDMI output signal is good. LED blinks Orange every second to indicate that the device is in F/W upgrade mode.</li> </ul>
2	IRPort	Connect the IR transmitter or receiver cable port into this mini stereo jack port.
3	RS-232 Port	Use the captive screw connectors (3 pole) to connect the cable from your serial device into the RS-232 port.

<b>No.</b>	<b>Component</b>	<b>Description</b>
4	HDMI Output Port	Connect the cable from your HDMI display device (monitors, projectors, TVs) into this port.
5	Firmware Upgrade Switch	Set this switch to OFF (left) for normal operation. Set this switch to ON (right) and reset the unit's power to enter firmware upgrade mode (see page 103 for details).
6	HDBaseT Input	Use a Cat 5e cable to connect the VE805R / VE816R to the VM8514 output board.
7	Power Jack	The power adapter cable plugs connects here.

# Chapter 2

## Hardware Setup



1. Important safety information regarding the placement of this device is provided on page 143. Please review it before proceeding.
2. Make sure that the power to all devices connected to the installation are turned off. You must unplug the power cords of any computers that have the Keyboard Power On function.

### Rack Mounting

---

The Modular Matrix Switch can be mounted in a 19" (1U) system rack. For the most convenient front panel operation at the local site, mount the unit at the front of the rack, as follows:

1. Position the unit in the front of the rack, and align the holes of the unit's built-in mounting brackets with the holes in the rack.
2. Use screws to attach the unit to the rack.

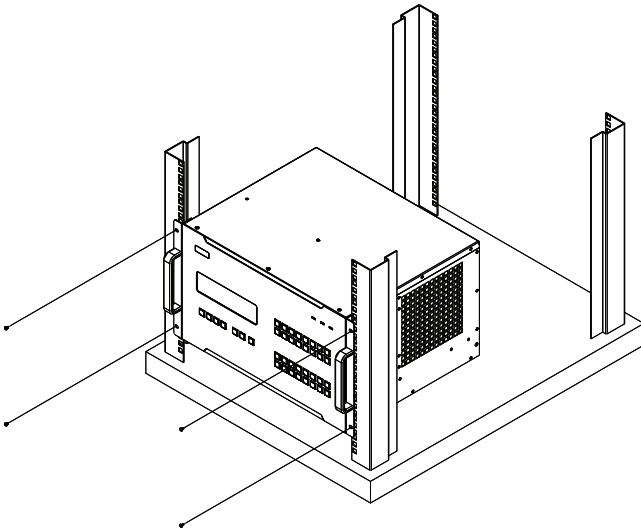

## Mounting with Brackets

You can also use mounting brackets to install the VM1600A, as shown below.

---

**Note:** The Mounting Kit is not included with the package. To purchase a mounting kit please contact your dealer.

---

1. Screw the mounting brackets (Easy Installation Rack Mount Kit, see page 16) to the rack, as shown in the diagram.

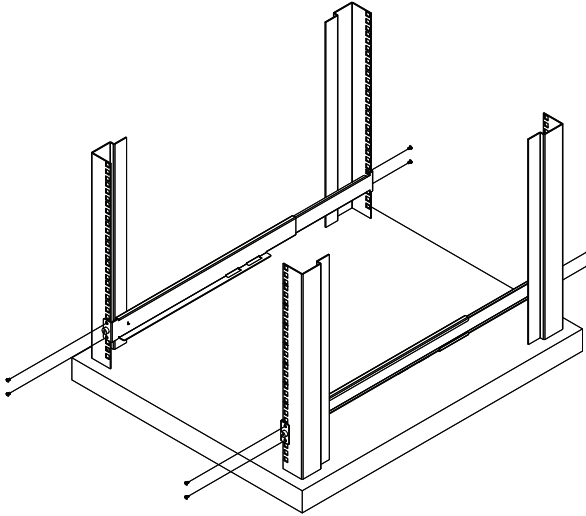

2. Slide the unit along the brackets, then screw the front panel to the rack.

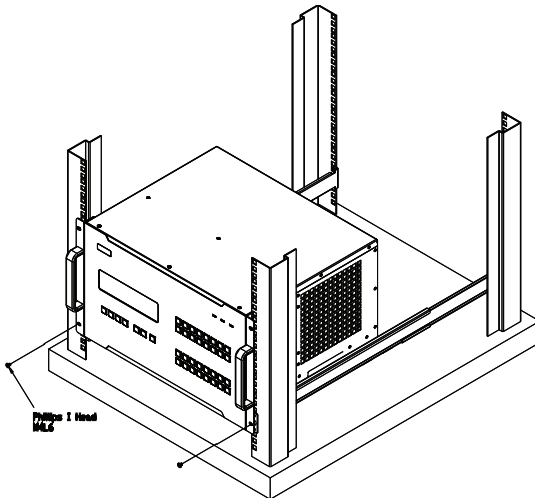



---

## Grounding

---

To prevent damage to your installation, it is important that all devices are properly grounded.

1. Use a grounding wire to ground the installation using the VM1600A's rear panel, by connecting one end of the wire to the grounding terminal, and the other end of the wire to a suitable grounded object.

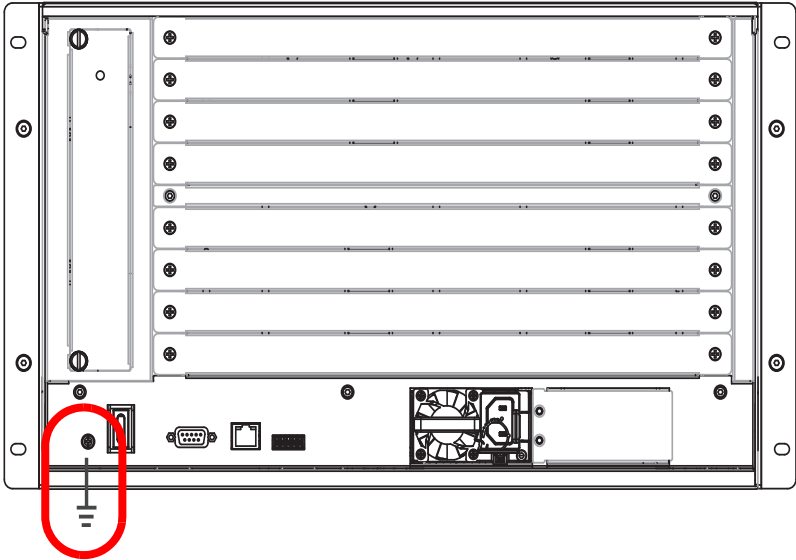

2. Make sure that all devices in your installation are properly grounded.

---

**Note:** The grounding wire is not included in the package. Please contact your dealer for details of purchase.

---

## Input / Output Board Installation

---

To install the I/O boards in the VM1600A, do the following:

**Note:** The four top slots on the Modular Matrix Switch are for the Input boards. The four bottom slots on the Modular Matrix Switch are for the Output boards.

---

1. On the rear of the VM1600A, unscrew the two screws from a top and bottom slot, and remove the covers.

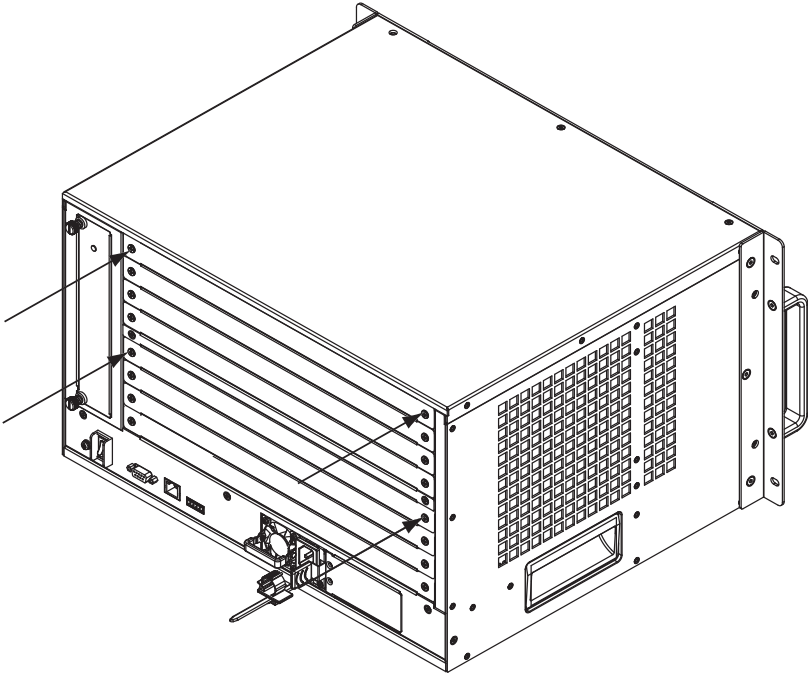

*(Continues on next page.)*

2. Slide an input board into a top slot and tighten the screws to secure the board to the VM1600A.

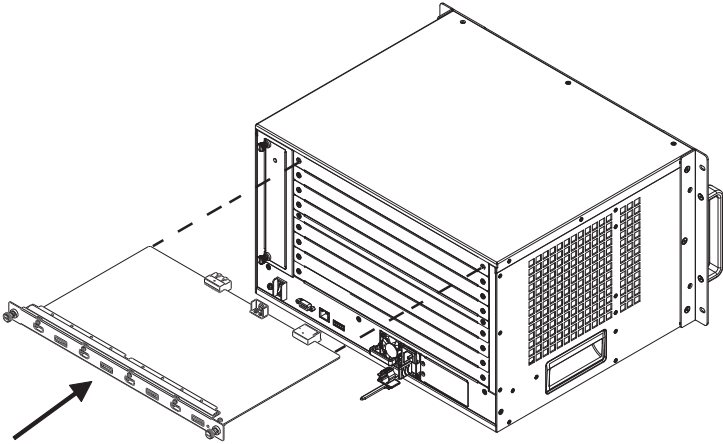

3. Slide an output board into a bottom slot and tighten the screws to secure the board to the VM1600A.

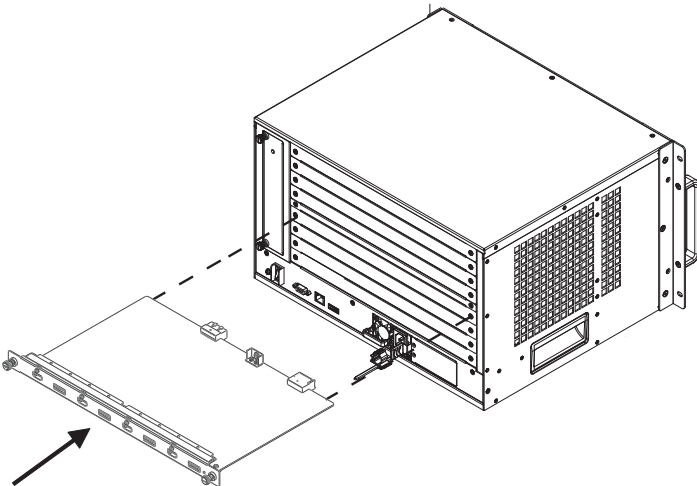

4. Repeat steps 2 and 3 to install additional I/O boards.
5. Power on the VM1600A.

## Cable Connection

---

Installation of the VM1600A is simply a matter of connecting the appropriate cables. Refer to the installation diagram on the following page (the numbers in the diagram correspond to the steps below), and do the following:

1. Use a grounding wire to ground the unit by connecting one end of the wire to the grounding terminal, and the other end of the wire to a suitable grounded object.

---

**Note:** Do not omit this step. Proper grounding helps to prevent damage to the unit from surges or static electricity.

---

2. Unscrew the covers on the VM1600A rear panel and insert the I/O boards into the horizontal slots (See *Input / Output Board Installation*, page 30, for details).
3. Connect your A/V source device(s) to the **Video and Audio port(s)** of the Input Board on the VM1600A.
4. Connect your video display device(s) to the **Video port(s)** of the Output Board on the VM1600A.
5. Connect your speakers / audio output device(s) to the **Audio port(s)** of the Output Board on the VM1600A.
6. (Optional) If using the remote operation features (web GUI), plug a Cat 5e cable from the network into the VM1600A's **Ethernet** port.
7. (Optional) If you are using a serial control function, use an appropriate serial cable to connect the computer or serial controller to the VM1600A's female **RS-232** serial port.
8. (Optional) If you are using the serial control function to control multiple VM1600A's, use an appropriate serial cable to connect the computer or serial controller to the VM1600A's female **RS-485 / RS-422** captive screw connector. The VM1600A package includes a terminal block connector that can be used for this connection.
9. Plug the power cord supplied with the package into the VM1600A's 3-prong socket, and then into a power source.

10. (Optional) Plug in an additional power module for redundancy if required.

**Note:** Secondary power modules are not included in the VM1600A package.  
See *Optional Equipment*, page 16, for details.

11. Power on the VM1600A and all devices in the installation.

## Installation Diagram

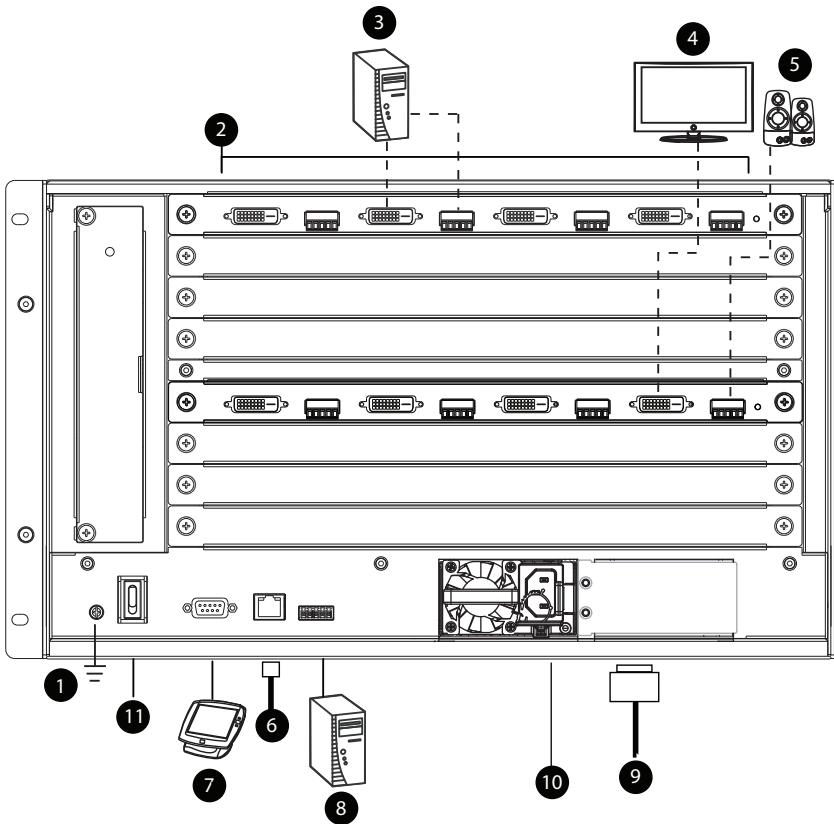

This Page Intentionally Left Blank

# Chapter 3

## Front Panel Operation

### Overview

---

The Modular Matrix Switch installation can be configured and operated locally via the VM1600A front panel LCD and pushbuttons.

### Front Panel Pushbuttons

---

The VM1600A front panel has easy-to-use pushbuttons for selecting which video/audio source shows on which display.

### Basic Navigation

The VM1600A's front panel LCD display operation is easy and convenient. Please note the following front panel button operations:

- ◆ Press the **VIDEO** pushbutton to configure the video connections.
- ◆ Press the **AUDIO** pushbutton to configure the audio connections.
- ◆ Use the **MENU** pushbutton to:
  - ◆ Access the Menu page options: IP Setting, Serial Port Setting, Operation Mode, Security Mode, and Save to a Profile.
  - ◆ Awake the VM1600A from standby mode.
- ◆ Use the **PROFILE** pushbutton to select a profile or switch between the connection profiles which have been added to the Profile List (see page 63). Pressing this pushbutton for longer than 3 seconds displays the Save to a Profile page (see page 58).
- ◆ Use the **CANCEL** (⏮) pushbutton to go back a level, return to the Main screen, stop or exit an operation.
- ◆ Use the **UP** (⬆) and **DOWN** (⬇) pushbuttons to go to the next or previous options.
- ◆ Use the Input / Output (**1–16**) pushbuttons to select the Input/Output port. The pushbuttons may also correspond to menu options, profiles, and so on.

---

## Front Panel LCD

---

The VM1600A features an LCD display for convenient configuration. This allows you to perform operations such as viewing the IP settings, configuring the serial port, setting EDID/CEC/OSD/Output Status, selecting security settings, and loading/saving connection profiles.

### LCD Password

If the VM1600A has been configured to require a password for local operation (see *Security Mode*, page 55), the password screen appears when the VM1600A is powered on, and the cursor flashes on the first digit. Enter a 4-digit password to continue to the Main Screen.

---

**Note:** If you are accessing the VM1600A for the first time, the default password is 1234.

---

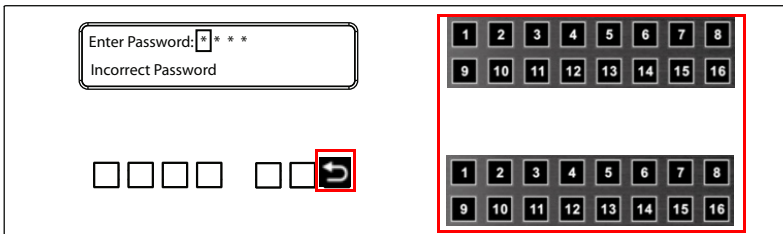

To enter a password, do the following:

1. Check that the cursor is flashing on the first digit.
2. Use the front panel number pushbuttons (1-9) to enter a 4-digit password. After the fourth digit, the cursor goes back to the first digit.
3. Press **Cancel** to clear the password. The digits revert to 4 asterisks (\*) and the cursor returns to the first digit.

- 
- Note:**
1. The VM1600A password can be any four digit combination between 1111 to 9999.
  2. If you enter an incorrect password, the cursor goes back to the first digit and reverts to flashing. The Incorrect Password message displays at the bottom of the screen, but clears as soon as a new digit is entered.
  3. If Password (see *Security Mode*, page 55) is Enabled, the LCD display time-out is 5 minutes by default.
-



## Port Switching

From the Main Screen, you can configure the Input-to-Output port connections to associate an Input source device to an Output display.

### Video / Audio Pushbutton

Before switching port connections, use the **Video** or **Audio** pushbuttons to select whether to switch only the video or the audio signal exclusively. Otherwise, both video and audio channels are configured together (default).

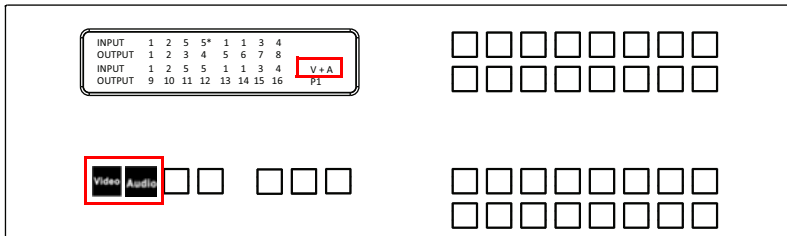

- ◆ Press the **Video**\* pushbutton to configure Video connections. The built-in LED lights up and the LCD displays **Video** on the lower right side. Press the button again to cancel.
- ◆ Press the **Audio**\* pushbutton to configure Audio connections. The built-in LED lights up and the LCD displays **Audio** on the lower right side. Press the button again to cancel.
- ◆ If both **Video** and **Audio** built-in LEDs are turned off, the video and audio channels are configured together and the LCD displays **V + A**.

---

**Note:** Press the **Video** or **Audio** pushbutton to independently switch either signal to a different source.

---

## Input Port Selection

Use the Input Port pushbuttons to select the Input port you want to configure.

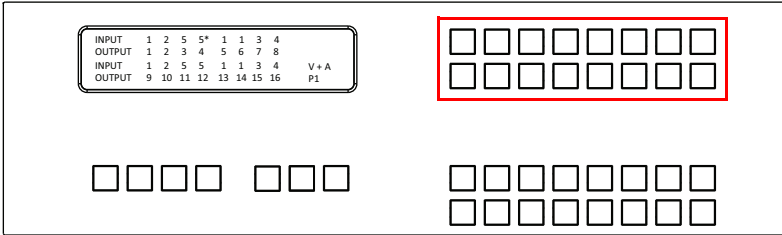

To select which input source displays on each output port, do the following:

1. Press any Input port pushbutton. The Output port LED(s) tied to the said Input port will begin to flash. Available Output port LED(s) will light up (steady).

In the example below, pressing Input port **1** shows it is tied to Output ports **1** and **2**.



2. To disconnect an Output port from an Input port, press the corresponding Output port pushbutton.

In the example below, Output port **2** has been disconnected from Input port **1**.

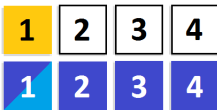

3. To switch to another Input port, press any Input port pushbutton. The Output port LED(s) tied to the said Input port will flash.

In the example below, pressing Input port **2** shows it is tied to Output ports **3** and **4**.



- To connect Output port **2** to Input port **2** in the example above, press the Output port **2** pushbutton. The Output port 2 LED will also begin to flash (0.5 sec on, 0.2 sec off). This indicates that Input port **2** is now connected to Output ports **2**, **3** and **4**.



Once the signal from the selected Input port is successfully tied to the Output port, the LEDs turn off and the LCD information is updated.

- 
- Note:**
- Pressing an Input port a second time deselects it.
  - Input ports that are not configured or tied to any output port do not appear in the LCD screen.
  - Pressing the **Cancel** pushbutton once stops the Input Port Selection operation and the LCD displays the active setting. Pressing the **Cancel** pushbutton again turns all LEDs off.
  - After 10 seconds of inactivity, all the LEDs turn off.
-

## Output Port Selection

Use the Output Port pushbuttons to select the Output port you want to configure.

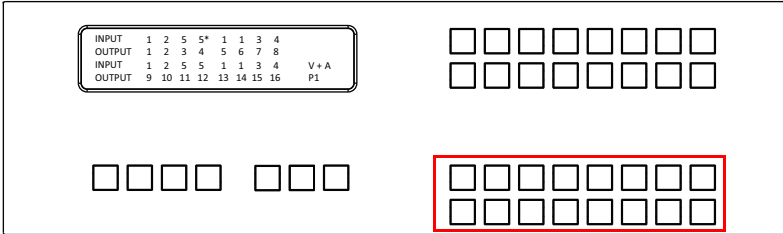

To select which output display corresponds to each input source, do the following:

1. Press any Output port pushbutton (1-16). The selected Output port LED lights steady.

In the example below, Output port **1** pushbutton has been pressed. Available Input ports light up. Because no Input LEDs are flashing, no ports have already been assigned to Output port **1**.



2. If an Output port pushbutton is pressed a second time, it is deselected and the LED turns off.
3. To connect the selected Output port(s) to an Input port, press the Input port pushbutton to which you want the Output port(s) tied. The newly selected Input port LED flashes (0.5 sec on, 0.2 sec off), and the LCD information is updated.

In the example below, pressing Input port **2** ties it to Output ports **2, 3** and **4**.



4. To switch Output ports **2**, **3** and **4** to another Input port (and disconnect it from Input port **2**), press another Input port pushbutton to which you want them tied.

In the example below, Input port **3** has been pressed and is now connected to Output ports **2**, **3** and **4**.



- 
- Note:**
1. Pressing an Output port a second time deselects it.
  2. Pressing the **Cancel** pushbutton once stops the Output Port Selection operation, and the LCD displays the active setting. Pressing the **Cancel** pushbutton again turns all LEDs off.
  3. After 10 seconds of inactivity, all the LEDs turn off.
-

## Profile Pushbutton

From the Main screen; pressing the **PROFILE** pushbutton switches between the connection profiles added to the Profile Selection list (see *Setting the Standby Mode*, page 63). If a connection profile is in use, it is shown from the Main screen on the lower right corner of the LCD display.

INPUT	1	2	5	5*	1	1	3	4		
OUTPUT	1	2	3	4	5	6	7	8		
INPUT	1	2	5	5	1	1	3	4	V + A	
OUTPUT	9	10	11	12	13	14	15	16	P1	



- ◆ Use the front panel number pushbuttons to select a profile:
  - ◆ **Input** ports 1–16 correspond to Profile **P1** to **P16**
  - ◆ **Output** ports 1–16 correspond to Profile **P17** to **P32**

---

**Note:** If a Profile is available for selection, its corresponding Input/Output port LED lights.

---

The selected pushbutton lights steady, and the VM1600A immediately applies the port connections configured in the Profile. The selected Profile is shown as **P1-P32** in the LCD's lower right corner.

- ◆ **Up** and **Down** buttons correspond to the previous or next profile in the Profile List, which can be edited via the GUI.

If there are no profiles configured, an error message “*No Profile List defined. Profile List can be edited via the Web GUI.*” is displayed.

- ◆ The Profile List and connections can be edited from the *Profile List* page of the Browser GUI. See *Setting the Standby Mode*, page 63.
- ◆ Press the **Cancel** pushbutton to turn off the Profile LED.
- ◆ Pressing the **Profile** pushbutton for longer than 3 seconds displays the *Save to a Profile* page (see *Save to a Profile*, page 58).

---

**Note:** To save a configuration to a profile using the Front Panel pushbuttons, follow the steps in *Save to a Profile*, page 58.

---

## LCD Menu

Use the **Menu** pushbutton to switch between the Main Screen and Menu page. From the Main Screen press the **Menu** pushbutton to access the Menu page; use the pushbuttons (1-16) to cycle through the menu options, starting from IP Setting, in the order show in the table below:

Menu Page	Sub-Menu Page(s)			
IP Setting	IP Address			
	Subnet Mask			
	Gateway			
Serial Port Setting	Baud Rate	9600 / <b>19200</b> / 38400 / 115200		
Operation Mode	EDID	<b>Default</b> / Port1 / Remix / Customized		
	CEC	On / <b>NA</b>		
	OSD	On / NA		
	Output Status	Video	<b>On</b> / NA	
		Stereo Audio	01-16	
Output Resolution		01-16		
Security Mode	Mode	<b>None</b>		
		Password Enable		
		Lock Screen		
	Change Password	Old Password	New Password	
Save to a Profile	Save to a Profile No.	01-32		
Play/Stop the Profile Schedule				
Turn Video Wall Off				

- Note:**
1. The highlighted values are the default settings of the VM1600A.
  2. Upon VM1600A startup, check the front panel LCD to view the loading progress. If the LCD Menu fails to load, an error message displays. Reset the unit and try again.

## LCD Main Screen

The Main Screen shows the Input–Output port pairs, with the Output ports shown in sequential order (1–16) at the bottom half.

INPUT	1	2	5	5*	1	1	3	4		
OUTPUT	1	2	3	4	5	6	7	8		
INPUT	1	2	5	5	1	1	3	4	V + A	
OUTPUT	9	10	11	12	13	14	15	16	P1	

- ◆ The front panel pushbutton label (1–16) corresponds to the **Input** ports and **Output** ports on the unit’s rear panel.
- ◆ Use the **Menu** pushbutton to go to the Menu page.
- ◆ Use the **Profile** pushbutton to switch between profile connections (see *Setting the Standby Mode*, page 63).



## IP Setting

To view the VM1600A's IP settings, press the **Menu** pushbutton (lights). This takes you to the Menu page, shown below:

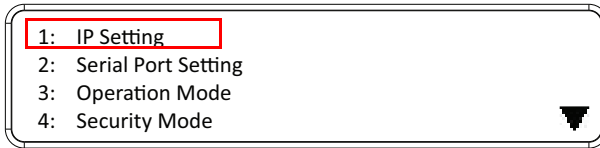

1. From the Menu page:
  - ◆ Press **1** to go to the IP Setting page.
  - ◆ Press **2** to go to the Serial Port Setting page.
  - ◆ Press **3** to go to the Operation Mode page.
  - ◆ Press **4** to go to the Security Mode page.
  - ◆ Press **Down** button to go to the next page.
  - ◆ Press **Menu** to return to the Menu Screen.
  - ◆ Press **Cancel** to return to the Main Screen.
2. After pressing **1**, the IP address, Subnet Mask and Gateway information are shown:

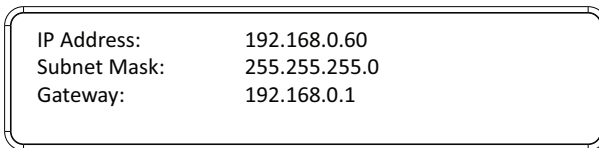

- ◆ The default IP address is 192.168.0.60.
  - ◆ The default Subnet Mask is 255.255.255.0.
  - ◆ The default Gateway is 192.168.0.1.
3. Press **Cancel** to return to the previous step without change.

## Serial Port Setting

---

To configure the VM1600A's serial port settings, select Serial Port Setting from the Menu page.

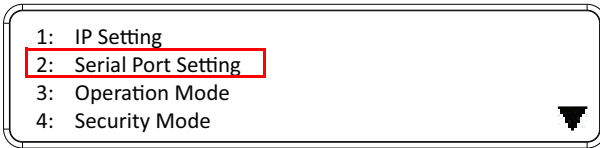

### Serial Port Address Setting

To set the VM1600A's serial port address, do the following:

1. Select **Serial Port Address Setting** from the Serial Port Setting submenu by pressing **1**:

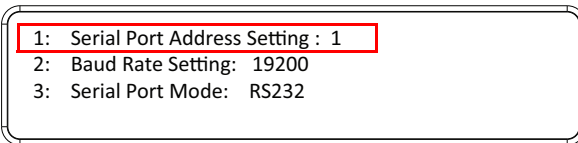

2. Press pushbuttons 1–16 to make your selection.

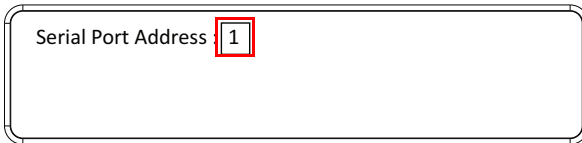

---

**Note:** The default serial port address is 1. This address is used for RS422/485 commands to control multiple VM1600A's.

---

3. Press **Menu** to return to the Menu page.
4. Press **Cancel** to return to the previous step without saving.

## Baud Rate

1. Select **Baud Rate Setting** from the Serial Port Setting submenu by pressing **2**:

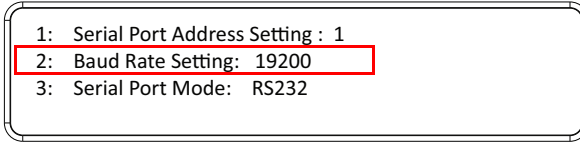

2. Press pushbuttons 1–4 to make your selection.



Baud Rate options are:

- ◆ 1: 9600
- ◆ 2: 19200
- ◆ 3: 38400
- ◆ 4: 115200

---

**Note:** The default baud rate is 19200.

---

3. Press **Menu** to return to the Menu page.
4. Press **Cancel** to return to the previous step without saving.

## Serial Port Mode

1. Select **Serial Port Mode** from the Serial Port Setting submenu by pressing **3**:

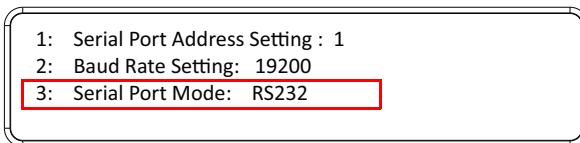

2. Press pushbuttons 1–2 to make your selection.



1: RS232 (In use)  
2: RS422/RS485

Serial Port options are:

- ◆ **1:** RS-232
- ◆ **2:** RS-422 / RS-485

---

**Note:** The default serial port mode is RS-232.

---

3. Press **Menu** to return to the Menu page.
4. Press **Cancel** to return to the previous step without saving.

## Operation Mode

The EDID, CEC, OSD and Output Status features are adjusted from the Operation Mode menu.

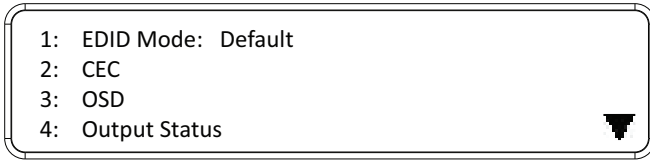

- ◆ EDID (extended display identification data) is used to apply a preset video configuration (EDID Mode), which utilizes the best resolution across different monitors.
- ◆ Consumer Electronics Control (CEC) allows interconnected HDMI devices to communicate and respond to one remote control.
- ◆ The OSD, when enabled for a port, displays real-time port switching information on the screen.
- ◆ The Output Status shows whether the video/audio of an Output port is turned on or off.

### EDID

To adjust the EDID mode, do the following:

1. From the Operation page, press pushbutton **1** to access the EDID Mode page:

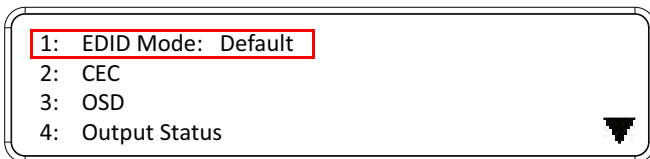

2. Press pushbuttons 1-4 to make your selection.

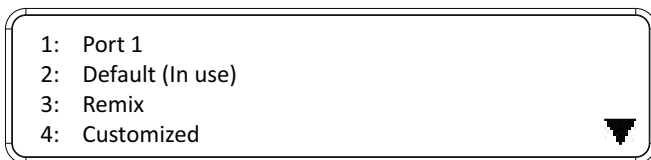

EDID Mode options are:

EDID Option	Description
1: Default	ATEN's default EDID data is passed to all video sources by default when the system is powered on.
2: Port1	EDID data read from port 1 is passed to all video sources. The system will enforce the Default EDID setting if port 1 is not occupied.
3: Remix	This mode reads the EDID data from all connected displays and generates the optimum EDID for all video sources. The system will not re-generate a new EDID when a new device is plugged in, unless triggered by a pushbutton or command.
4: Customized	This mode features an EDID Wizard that allows user-defined EDID configurations for optimum output. See <i>Customized Mode</i> , page 96.

3. Press **Menu** to return to the Menu page.
4. Press **Cancel** to return to the previous step without change.

---

**Note:** The default EDID setting is Default.

---

**CEC**

To configure the CEC settings, do the following:

1. From the Operation page, press pushbutton **2** to access the CEC page:

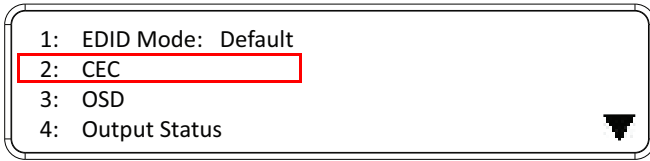

2. Press pushbuttons 1–16 to enable (**ON**) or disable (**NA**) the CEC feature for the output port. If the port does not support CEC, an **NA** is shown.

OUTPUT	1	2	3	4	5	6	7	8
	NA	NA	NA	NA	ON	NA	ON	NA
OUTPUT	9	10	11	12	13	14	15	16
	ON	ON	ON	ON	NA	NA	NA	NA

---

**Note:** The default CEC setting is Off.

---

3. Press **Menu** to return to the Menu page.
4. Press **Cancel** to return to the previous step without saving.

## OSD

The On-Screen Display or OSD feature enables real-time text updates to appear on the display device's screen for any configuration changes made to the Output port via the VM1600A's front panel, remote control or Web GUI.

To configure the OSD setting for each output port, do the following:

1. From the Operation page, press pushbutton **3** to access the OSD page:

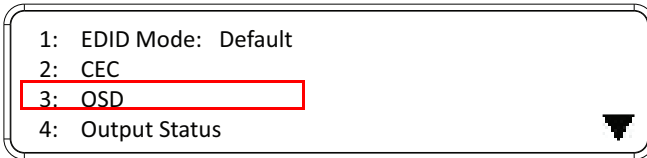

2. Press pushbuttons 1–16 to enable (**ON**) or disable (**NA**) the OSD feature for the port.

OUTPUT	1	2	3	4	5	6	7	8
	NA	NA	NA	NA	ON	NA	ON	NA
OUTPUT	9	10	11	12	13	14	15	16
	ON	ON	ON	ON	NA	NA	NA	NA

---

**Note:** The default OSD setting is Off.

---

3. Press **Menu** to return to the Menu page.
4. Press **Cancel** to return to the previous step without saving.



## Output Status

To configure the Output Status settings for each output port, do the following:

- From the Operation Mode screen, press pushbutton **4** to access the Output Status page:

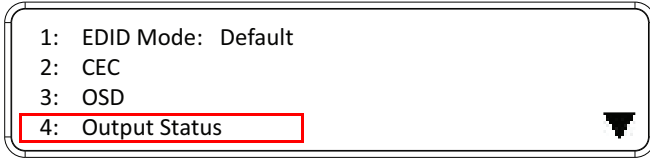

- Press pushbuttons 1–3 to select whether you want to configure the video, stereo audio, or output resolution for output ports.



- If configuring the output port status for video, press pushbuttons 1–16 to enable (**ON**) or disable (**NA**) the video channel:

OUTPUT	1	2	3	4	5	6	7	8
	NA	NA	NA	NA	ON	NA	ON	NA
OUTPUT	9	10	11	12	13	14	15	16
	ON	ON	ON	ON	NA	NA	NA	NA

**Note:** The default Output Status setting is On.

- If configuring the output port status for stereo audio, press pushbuttons 1–16 to select the output port. Adjust the audio volume for the port by pressing the **Up** or **Down** pushbutton:

OUTPUT	1	2	3	4	5	6	7	8
	0	10	[1]	4	8	8	8	8
OUTPUT	9	10	11	12	13	14	15	16
	0	10	10	4	8	8	8	8

**Note:** The audio volume range from 0 (mute) and 1 (~27dB) to 10 (0dB). The default audio volume is 10.

5. If configuring the output video resolution, press pushbuttons 1–16 to select the output port. Next, select the preferred output resolution.
6. Press **Menu** to return to the Menu page.
7. Press **Cancel** to return to the previous step without saving.

## Security Mode

---

The Security Mode page allows you to configure the VM1600A's password-related settings; the **Password** page sets the VM1600A to require a password for local operation after the LCD display times out (default time out: 5 minutes) or is powered off/on. The **Change Password** option allows you to set a new password for the VM1600A.

To configure the VM1600A's password settings from the Main Screen, use the **Menu** pushbutton to access the Menu page, then press pushbutton **4** to access the Security Mode page.



### Mode

1. To set the VM1600A so that it requires a password for local operation, press pushbutton **1** in the Security Mode page.

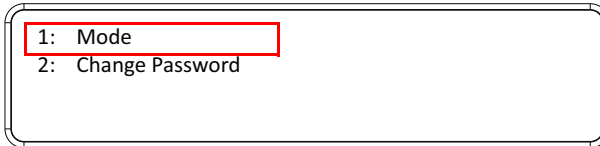

2. To disable security settings, press pushbutton **1**.
3. To require a password after the LCD display times out or is powered off/on, press pushbutton **2**.
4. To enable a lock screen, press pushbutton **3**. When Lock Screen is enabled, pressing any pushbutton from the home screen will trigger the following message: *Please press "Menu" to start.*

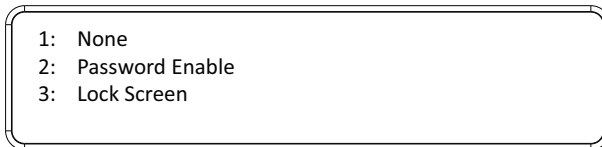

---

**Note:** By default the password requirement is disabled. If the password is enabled, the LCD display's default time-out is 5 minutes.

---

5. Press **Menu** to return to the Menu page.
6. Press **Cancel** to return to the previous step without saving.

### Change Password

1. To change the password: from Security Mode, press pushbutton **2**.

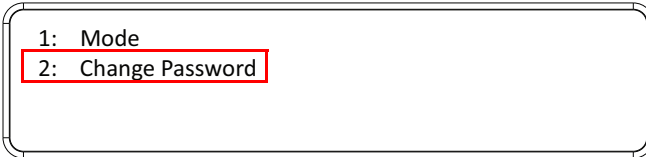

2. In the Old Password field, the cursor flashes at the first digit. Enter the old password (see *LCD Password*, page 36). If the old password is entered correctly, you can proceed to the next step. The default password is: **1234**.



---

**Note:** If you enter an incorrect password, the cursor goes back to the first digit and reverts to flashing. The Incorrect Password message clears as soon as a new digit is entered.

---

3. In the New Password field, the cursor flashes at the first digit. Enter the new password using the front panel number pushbuttons (1111–9999).

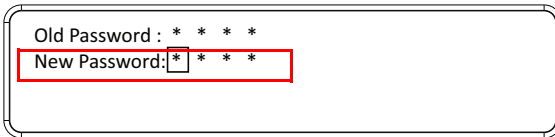

4. Re-enter the new password in the following screen. The new password is applied by the VM1600A immediately.

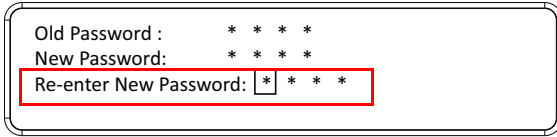

Old Password : \* \* \* \*  
New Password: \* \* \* \*  
Re-enter New Password: [ ] \* \* \*

If the password you entered does not match the one entered in the previous screen, an error message appears. Enter the new password correctly.

5. Press **Menu** to return to the Menu page.
6. Press **Cancel** to return to the previous step without saving.

## Save to a Profile

---

The VM1600A allows you to store up to 32 (P1–P32) different connection profiles that can be saved and recalled later. When profiles are saved, they are saved according to the current connection configuration on the Main Screen. When you load a profile, the change is immediate and the profile number is shown in the lower right corner of the LCD display. To save profiles, from the Main Screen do the following:

1. Use the **Menu** pushbutton to access the Menu page, and **Down** to navigate to the next page. Press pushbutton **1** to open the Save to a Profile page.

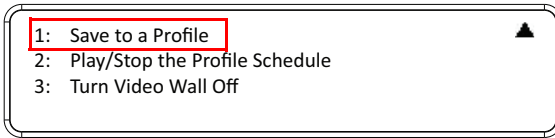

2. To save the active connection configuration as a profile use the front panel number pushbuttons to select a profile into which you want to save the configuration.

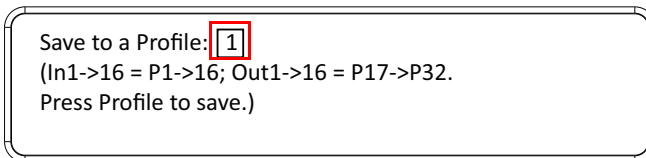

- ◆ Input ports **1–16** correspond to Profile **P1** to **P16**
  - ◆ Output ports **1–16** correspond to Profile **P17** to **P32**
3. Press the **Profile** pushbutton to store the connection configuration – the LCD shows a Profile Saved message.
  4. Press **Menu** to return to the Menu page.
  5. Press **Cancel** to return to the previous step without saving.

---

**Note:** You can also access the Save to a Profile page by pressing the **Profile** pushbutton for longer than 3 seconds.

---

---

## Play/Stop the Profile Schedule

---

Inputting port pushbutton **2** will Play or Stop the active Profile Schedule.

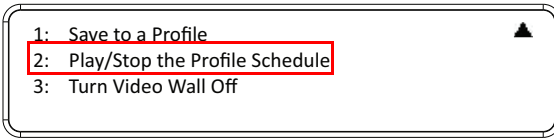

---

## Turn Video Wall Off

---

If a video wall is currently playing, a submenu will appear.

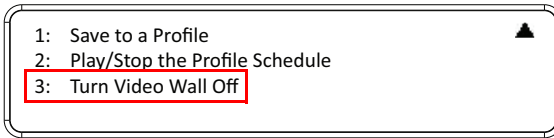

Selecting **Turn Video Wall Off** will return port assignments to their default (i.e. disassemble the video wall).

This Page Intentionally Left Blank



# Chapter 4

## Browser Operation

### Overview

---

The VM1600A can be configured over a standard TCP/IP connection via its built-in Graphical User Interface (GUI). Because it can be accessed from anywhere over a network or the Internet, operators can easily log in via web browser. Security is ensured by password protection and user-configurable time-out. The VM1600A supports three levels of remote users with various privileges, and up to 16 users can log into the GUI at one time. For full details see the sections that follow.

### Logging In

---

To access the GUI, type the VM1600A's IP address into the address bar of any browser. If a Security Alert dialog box appears, accept the certificate – it can be trusted. The login screen appears:

The screenshot shows a web-based login interface. At the top is a green rectangular button with the text "Login" in white. Below this are three input fields: "Username", "Password", and a language selection dropdown menu. The dropdown menu is currently set to "English" and has a small globe icon to its left. Below the language dropdown is a "Login" button.

- ◆ The default IP address is **http://192.168.0.60**
- ◆ The default Username and Password are: **administrator / password**
- ◆ Enter the username and password, then click **Login**.
- ◆ Use the drop-down menu to select the GUI language

---

**Note:** 1. The username supports lower case letters only.  
2. The same user can not be logged in simultaneously.

---

# Main Page

The main page opens to Profile List. Use Profile List to configure the input to output connections by creating profiles, import or export profiles, or create a profile schedule. The page is divided into three parts: the *Menu Bar*, *Profile List*, and *Profile Scheduling*.

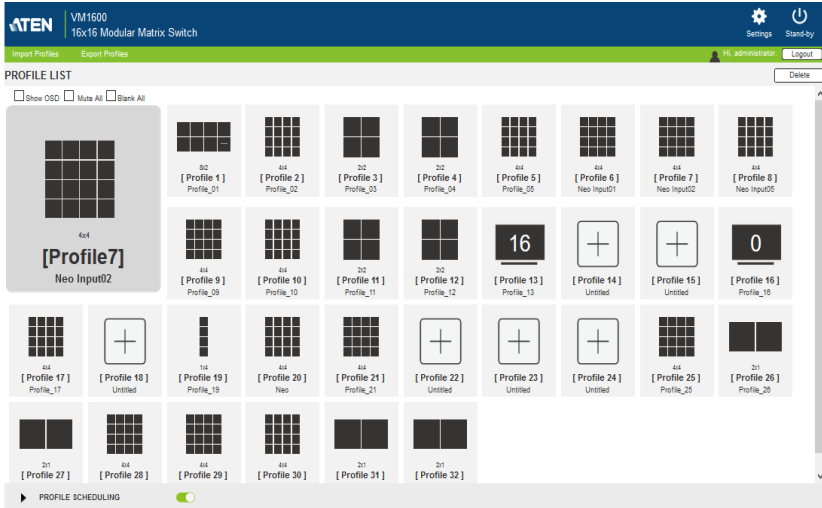

## Menu Bar

The Menu Bar provides the following controls:



Control	Description
Settings	Click to access the system settings. For details, see <i>System Settings</i> , page 83.
Profile List	Click to access settings on adding or editing profile adding/editing, profile import/export, and profile scheduling. For details, see <i>Profile List</i> , page 64.
Standby	Click to set the VM1600A to standby mode. For details, see <i>Setting the Standby Mode</i> , page 63.
Logout	Click to log out of the VM1600A web GUI.

### Setting the Standby Mode

The standby mode is a low-power mode where the VM1600A operates minimally by stopping all input and output transmissions and logging the user out of the web GUI.

To enable the standby mode, click  from the menu bar in the VM1600A web GUI.

To disable the standby mode, do one of the following:

- ◆ Press the **Menu** pushbutton from the device panel
- ◆ Log in the web GUI with a valid credential

# Profile List

The *Profile List* lets you create profile templates where the input to output port connections are defined. You can store up to 32 profiles that can be played manually or scheduled to be played for a specified time frame.

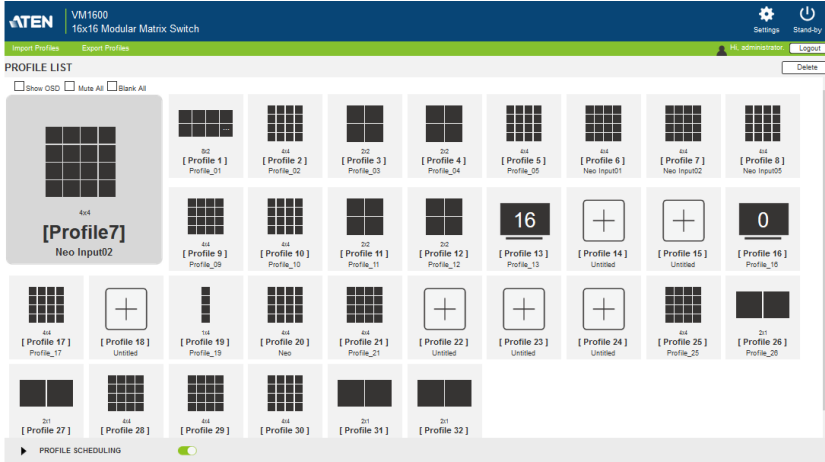

## Creating a Profile

1. From the Profile List, click an empty **[Profile]** icon. This window appears.

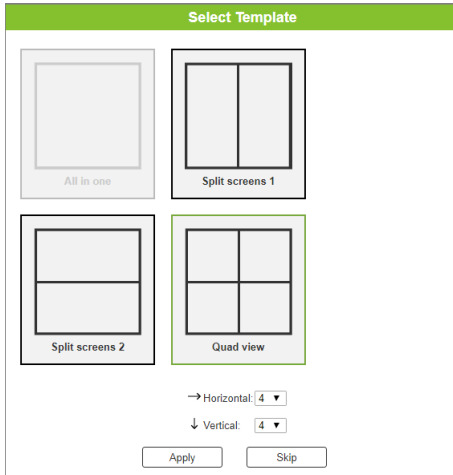

2. Click to select a profile layout and define the number of horizontal and vertical divisions to be fitted on the physical monitor layout.
3. Click **Apply**. This screen appears. In this example, the profile is set to a quad view (2 x 2 divisions), using 16 connected displays.

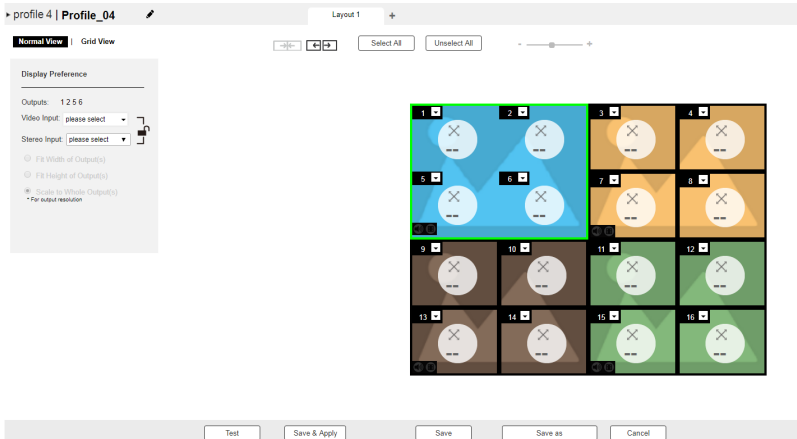

4. Select a monitor in the preview, and define the video input, stereo input, and scaling preference. Repeat this step with each of the screen in this profile.

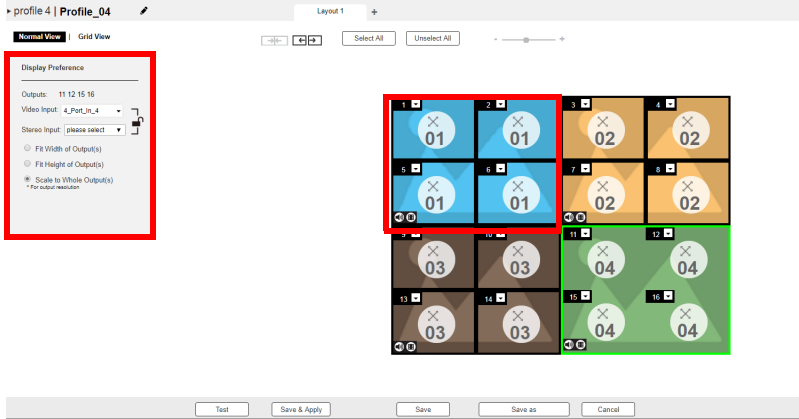

5. Click **Save**. This profile is added to the Profile List.

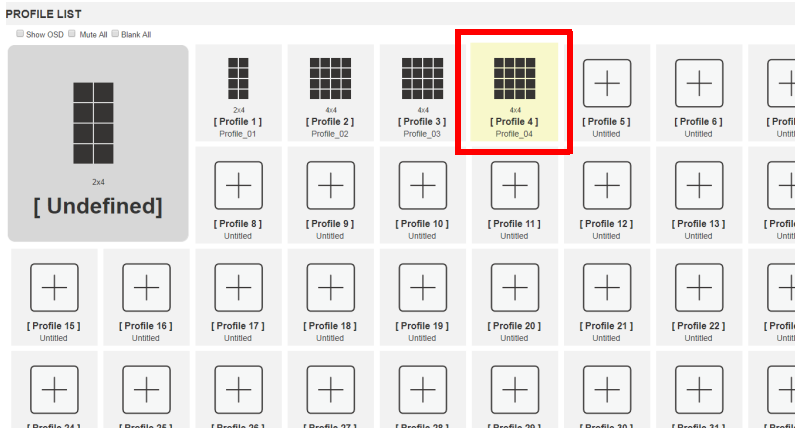

## Editing a Profile

1. Click a profile from the Profile List, and then click **Edit**. This screen appears.



2. Configure the following settings as required.

Settings	Details
Number of displays, output order	See <i>Profile Layout Settings</i> , page 68
Video and stereo source selections (using a video wall preview)	See <i>Display Preferences</i> , page 69
Video and stereo source selections (using a grid view)	See <i>Grid View</i> , page 70
Group settings and selecting inputs from the preview	See <i>Video Wall Settings</i> , page 71
Audio Outputs	See <i>Audio Output Settings</i> , page 76

3. (Optional) Click **Test** to apply your configuration without saving it.
4. To save your configuration, click **Save & Apply**, **Save**, or **Save As**.

## Profile Layout Settings

**Normal View** | Grid View

1. Number of Display 16/16

Video Wall Select Template

→ Horizontal: 4 ▼

↓ Vertical: 4 ▼



2. Output Order

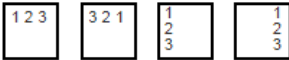

3. Bezel Dimension(unit: mm)

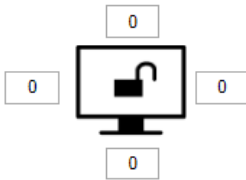

Control	Description
Number of Displays	<p>Use the following controls to configure the layout type and the number of displays.</p> <ul style="list-style-type: none"> <li>◆ <b>Video Wall:</b> Select this option for displays that are tiled together, where multiple monitors form one large screen – in various arrangements.</li> <li>◆ <b>Select Template:</b> Click to open a window that allows you to select a predefined video wall layout.</li> <li>◆ <b>Horizontal / Vertical:</b> Use these drop-down lists to select the number of displays that make up the video wall (a maximum of 64 are supported). Match this to the physical layout of the displays.</li> </ul> <p><b>Note:</b> Click <b>Apply</b> to save the changes. A preview of the profile is shown on the right of the screen.</p>
Output Order	Click any of the listed options to automatically assign output ports.
Bezel Dimension	Use the four boxes to increase/decrease the frame size for each active display.



Control	Description
Monitor Lock / Unlock 	Click the monitor icon to <b>Lock</b> the (4) bezel settings, so that when one size is changed they all change.  Click the monitor icon to <b>Unlock</b> the (4) bezel settings, so that each size can be set independently.

## Display Preferences

You can configure the video and stereo inputs and the display scale of a batch of displays. In a profile template, click one or more displays from the preview to highlight them in green, and then configure the settings from the left panel as required.



Option	Description
Output	This indicates the selected displays.
Video Input	Click to select a video source for the output(s). The chosen video source (port number) is indicated at the center of the output(s) in the preview.
Stereo Input	Click to select a stereo source for the output(s). The chosen audio source (port number) is indicated on the upper-left corner of the output(s) in the preview.
Lock / Unlock 	Click <b>Lock</b> to set the audio input to the same source with the video input. Click <b>Unlock</b> to set different sources for the video and audio input.
Radio Button	<ul style="list-style-type: none"> <li>◆ <b>Fit Width of Output(s)</b>: fits the video to the width of the display.</li> <li>◆ <b>Fit Height of Output(s)</b>: fits the video to the height of the display.</li> <li>◆ <b>Scale to Whole Output(s)</b>: fits the video on the entire display.</li> </ul>

## Grid View

The Traditional View allows you to select the **Input** to **Output** and **Audio** connections using a simple grid.

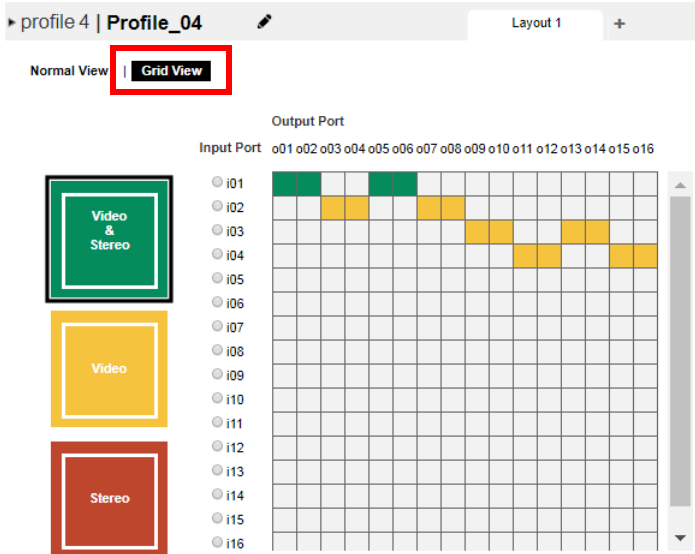



- ◆ Select: **Video & Audio**, **Video**, or **Audio** to set the input to output connection for the selected source.
- ◆ From an *Output Port* column, click a box to select its **Input Port**. The box will turn green, yellow or red.
- ◆ **Uncheck** an *Output Port* box to disable the video for that Output Port. The column will turn dark gray.
- ◆ **Check** an *Output Port* box to enable the video for that Output Port

## Video Wall Settings

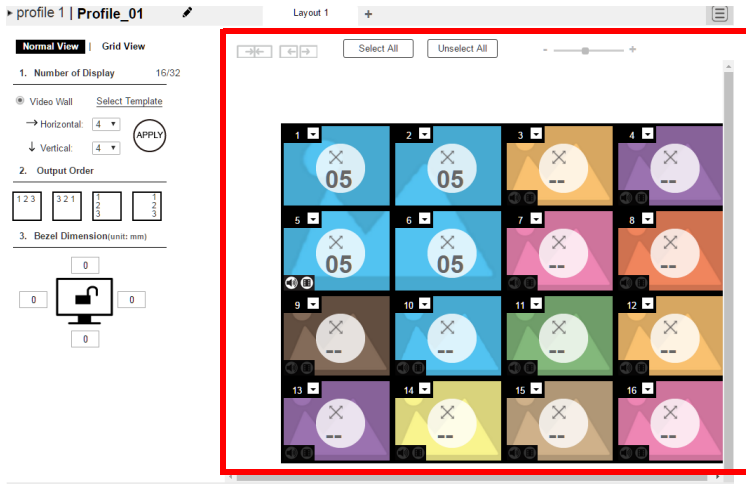
Each icon represents an Output port and the connected display. Use the icons to create Independent and Grouped Outputs. **Independent** Outputs will display video on a single monitor. **Grouped** Outputs will display video across multiple monitors as one large screen.



- ◆ Click an icon to choose its **Output** and **Video Input** from the *Display Preference* menu (see *Video Wall Example 1*, page 74).
- ◆ Click multiple icons to Group Outputs (see *Grouping*, page 73).
- ◆ Click **Select All** to select all outputs.
- ◆ Click **Unselect All** to unselect all outputs.
- ◆ Use the sidebar to zoom in and out of the display layout.
- ◆ On the *Top Bar* click:
  - ◆  to rename the profile
  - ◆  to add another layout to the profile
  - ◆  to configure audio outputs (*Audio Output Settings*, page 76)

**Null Input**



Option	Description
Null Icon	<p>Click Null Input icons to highlight icons in green and use the Display Preferences menu to set the video options (see <i>Video Wall Example 1</i>, page 74).</p> <p>Select a <b>single</b> icon to set the <b>Output</b> and <b>Video Input</b> for an independent display (see , page 72).</p> <p>Select <b>multiple</b> icons and set the <b>Video Input</b> to group displays as one screen (see <i>Grouping</i>, page 73). <i>You must first set the Output port for each icon.</i></p>
Drop-Down Menu	Use the drop-down menu to select the Output port.

**Independent Output**



Option	Description
Independent	<p>Independent Outputs are displays that have their own <b>Video Input</b> and <b>Output</b> selected. Independent Outputs:</p> <ul style="list-style-type: none"> <li>◆ Display their own video</li> <li>◆ Icons have their own color and Video Input</li> </ul> <p>Select an Independent Output and use the <i>Display Preferences</i> menu to select the <b>Video Input</b> (see page 74).</p>
Drop-down Menu	Use the drop-down menu (top-right corner) to select the Output port.
Mute / Video	<p>Click the <b>speaker</b> icon to mute the audio on/off.</p> <p>Click the <b>video</b> icon to turn the video off/on.</p>



## Grouping

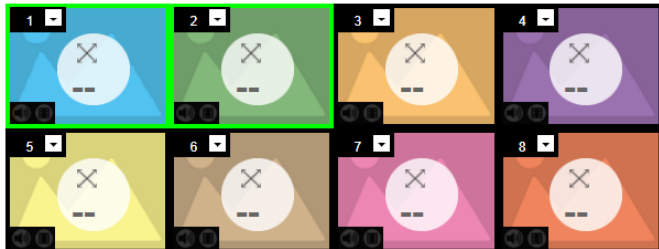

Option	Description
Grouping	Click multiple icons to Group Outputs (highlighted in green) and click → ← to group the displays into one screen. Use the <b>Display Preferences</b> menu to select the <b>Video Input</b> for the group - each Output icon in the Group will appear with the same Video Input number and icon color (see page 73).
Ungroup	Select a group and click ← → to ungroup the displays.

## Group



Option	Description
Group	<p>A <b>Group</b> (of Outputs) shares the same <b>Video Input</b> and displays the video together as one large screen. A Group of Outputs:</p> <ul style="list-style-type: none"> <li>◆ Displays video across multiple monitors to form one screen</li> <li>◆ Icons have the same color and Video Input number.</li> <li>◆ Select a Group and use the <i>Display Preferences</i> menu to select the <b>Video Input</b>.</li> <li>◆ To group outputs see <i>Grouping</i>, page 73.</li> </ul>
Mute / Video	<p>Click the <b>speaker</b> icon to mute the audio on/off.</p> <p>Click the <b>video</b> icon to turn the video off/on.</p>



### Video Wall Example 1

The example below shows a video wall with 8 displays.

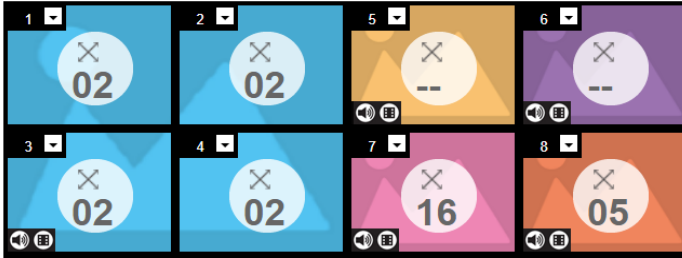

- ◆ Each Group and Independent Output has a unique color.
- ◆ This video wall has 1 **Group** and 4 **Independent** displays.
- ◆ The Group will show **Video Input 02** across all four displays as one large screen.
- ◆ The Independent displays will show the video from their own **Video Input** – 01, 07, 16 and 05.
- ◆ Add Display Layouts to create separate video walls (see *Video Wall Settings*, page 71).

**Video Wall Example 2**

The example below shows a video wall with 16 displays.



- ◆ Each Group and Independent Output has a unique color.
- ◆ This video wall has 3 *Groups* and 2 *Independent* displays.
  - ◆ The *Blue* Group will show **Video Input 02** across six displays as one large screen.
  - ◆ The *Brown* Group will show **Video Input 05** across six displays as one large screen (as if *Video Input 06* is a missing part of the entire screen).
  - ◆ The *Yellow* Group will show **Video Input 06** across two displays as one screen.
- ◆ The *Orange* and *Purple* Independent displays will show the video from their own **Video Input** – 03 and 04.

## Audio Output Settings

The Audio Control page is used to configure HDMI/stereo audio output settings. To access these settings, click , and then click **Output Option**.

**Note:** For more information on video output settings, see *Video*, page 107.

Audio Control

Port	HDMI Control		Stereo Control		Stereo_volume	
	Apply to All ▼		Apply to All ▼		Apply to All ▼	
Port1	HDMI	Use HDMI Audio ▼	Stereo	Use Stereo Audio ▼	+	Vol.10 -
Port2	HDMI	Use HDMI Audio ▼	Stereo	Use Stereo Audio ▼	+	Vol.10 -
Port3	HDMI	Use HDMI Audio ▼	Stereo	Use Stereo Audio ▼	+	Vol.10 -
Port4	HDMI	Use HDMI Audio ▼	Stereo	Use Stereo Audio ▼	+	Vol.10 -
Port5	HDMI	Use HDMI Audio ▼	Stereo	Use Stereo Audio ▼	+	Vol.10 -
Port6	HDMI	Use HDMI Audio ▼	Stereo	Use Stereo Audio ▼	+	Vol.10 -
Port7	HDMI	Use HDMI Audio ▼	Stereo	Use Stereo Audio ▼	+	Vol.10 -
Port8	HDMI	Use HDMI Audio ▼	Stereo	Use Stereo Audio ▼	+	Vol.10 -
Port9	HDMI	Use HDMI Audio ▼	Stereo	Use Stereo Audio ▼	+	Vol.10 -
Port10	HDMI	Use HDMI Audio ▼	Stereo	Use Stereo Audio ▼	+	Vol.10 -
Port11	HDMI	Use HDMI Audio ▼	Stereo	Use Stereo Audio ▼	+	Vol.10 -
Port12	HDMI	Use HDMI Audio ▼	Stereo	Use Stereo Audio ▼	+	Vol.10 -
Port13	HDMI	Use HDMI Audio ▼	Stereo	Use Stereo Audio ▼	+	Vol.10 -
Port14	HDMI	Use HDMI Audio ▼	Stereo	Use Stereo Audio ▼	+	Vol.10 -
Port15	HDMI	Use HDMI Audio ▼	Stereo	Use Stereo Audio ▼	+	Vol.10 -
Port16	HDMI	Use HDMI Audio ▼	Stereo	Use Stereo Audio ▼	+	Vol.10 -

- ♦ **HDMI Control / Stereo Control:** Use the drop-down menu to apply audio setting to all ports:
  - ♦ All Ports Use HDMI Audio.
  - ♦ All Ports Use Stereo Audio (uses the stereo audio port).
  - ♦ All Mute: mutes all ports.
- ♦ **Port\_ HDMI / Stereo:** Use the drop-down menu to apply audio settings to each port:
  - ♦ *Use HDMI Audio:* port uses the HDMI audio.
  - ♦ *Use Stereo Audio:* port uses the Stereo audio.
  - ♦ *Mute:* mutes HDMI/Stereo for the selected port.
- ♦ **Stereo Volume:** Use + *and* - to increase or decrease the audio level.



## Playing a Profile

1. Select the profile and click **Apply**.

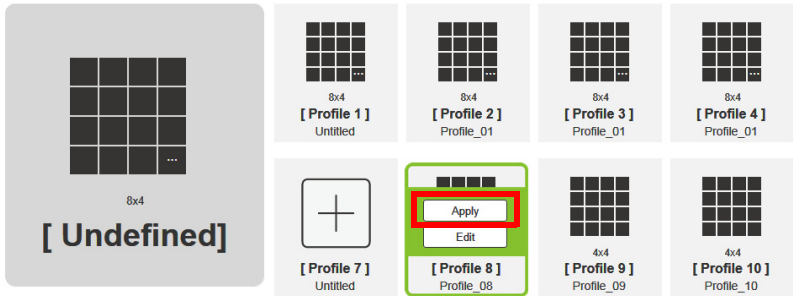

2. The profile appears in the large **Play** window and the connections start.

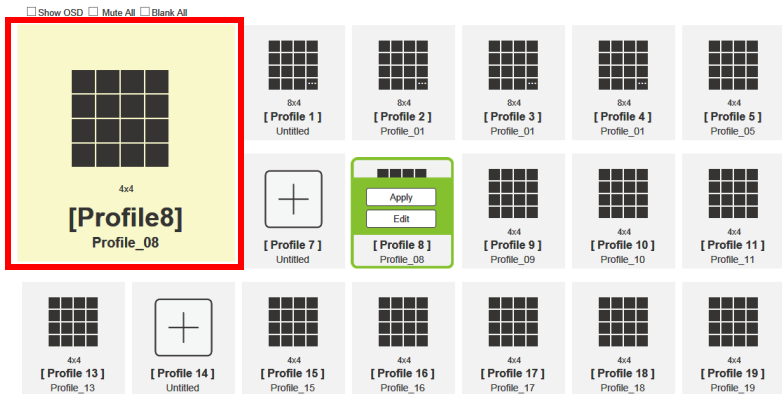

3. (Optional) Adjust the played profile using the following controls:

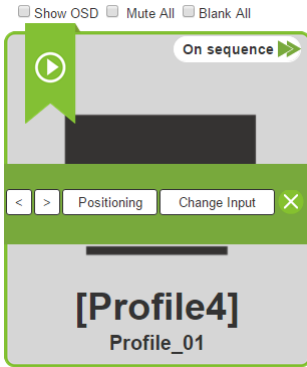

Option	Description
Show OSD	Check <b>Show OSD</b> to show the current connection status via OSD. When <b>Show OSD</b> is unchecked, the OSD will disappear.
Mute All	Check <b>Mute All</b> to mute the audio for all ports.
Blank All	Check <b>Blank All</b> to turn off the video to all displays.
On Sequence	<b>On Sequence</b> appears when a profile schedule is playing.
<	Click < to go back to the previous profile in the sequence, when Profile Scheduling is in use. Only available with <i>On Sequence</i> .
>	Click > to advance to the next profile in the sequence, when Profile Scheduling is in use. Only available with <i>On Sequence</i> .
Positioning	Click <b>Positioning</b> to open a window that allows you to adjust the image position on each display. For Video Wall profiles, you can also set the Bezel Dimension, which is the frame thickness between each display.
Change Input	Click <b>Change Input</b> to change the input for single and grouped outputs, as explained on the next page.
	Removes the profile from the Play window.

## Importing/Exporting a Profile

To export the VM1600A's connection profiles, do the following:

1. Click **Export Profiles**. A configuration file will then begin downloading.

To import connection profiles to the VM1600A, do the following:

1. Click **Import Profiles**.
2. Browse to the configuration file, select it and click **Open**.

---

**Note:** Importing a connection profile database will overwrite the current profiles.

---

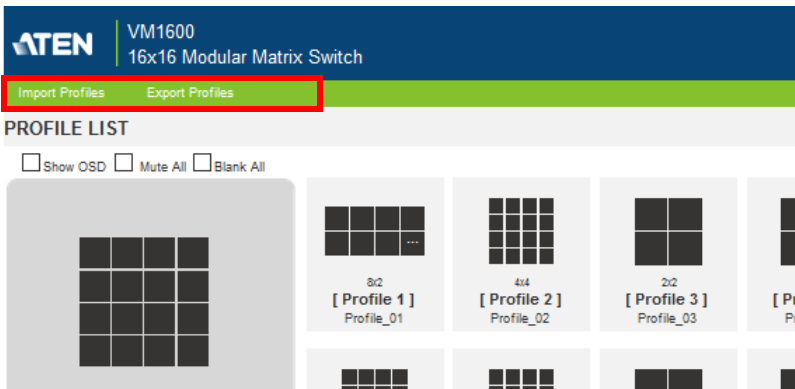

## Profile Scheduling

You can create profile schedules to play different profiles on specified time frames.

### Enabling/Disabling Profile Scheduling

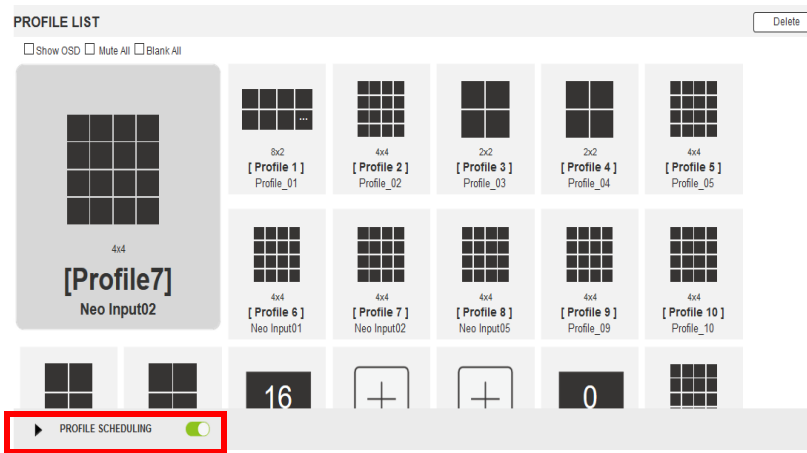

1. Go to the Profile List page.
2. Click the **PROFILE SCHEDULING** toggle button to enable (green) or disable (gray) profile scheduling. To configure profile schedule settings, see *Configuring Profile Schedules*, page 81.

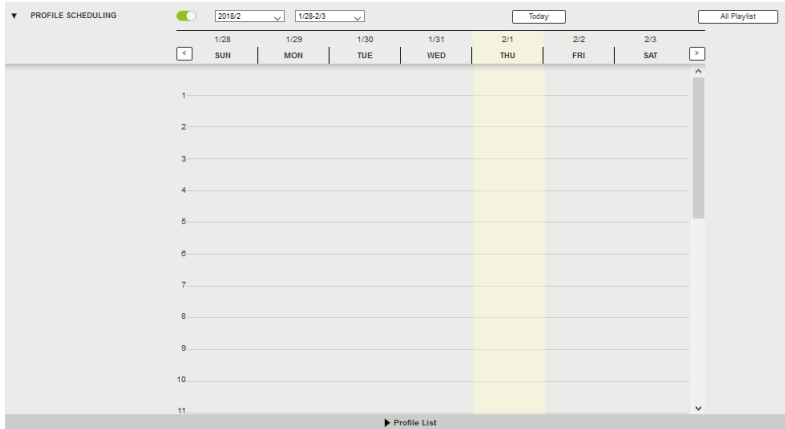

## Configuring Profile Schedules

1. From the Profile List page, click **PROFILE SCHEDULING**. A profile calendar appears.



2. To adjust the calendar and display a desired time frame, using the drop-down lists and/or   buttons.
3. Click **Profile List** at the bottom of the page. The Profile List appears.

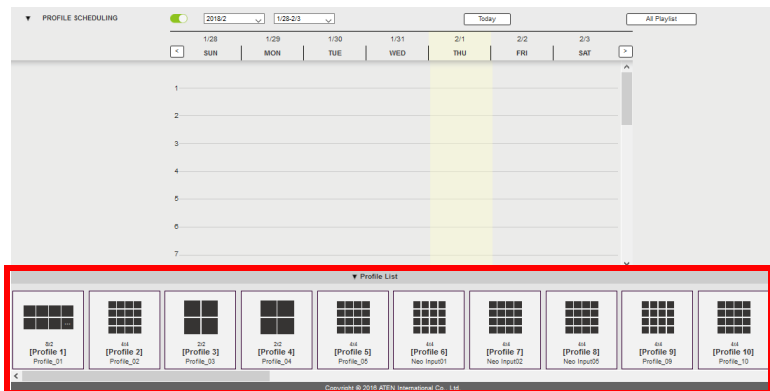



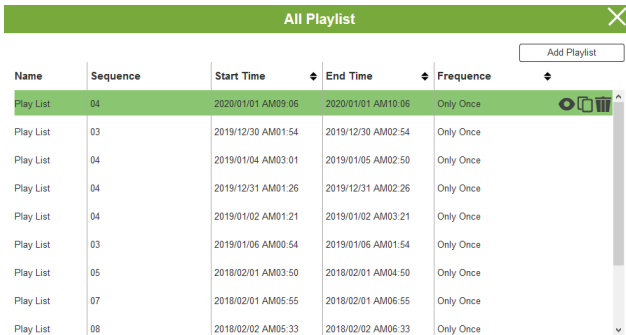

4. From the Profile List, drag and drop profiles onto the desired time on the calendar view. Optionally right-click the profile to copy, remove, or view its settings.

- To view a playlist of the scheduled profiles, click **All Playlist**. A play list appears.



You can have access to the following controls.

Control	Description
 Add Playlist	Click to add profiles from the Profile List to the playlist.
 View	Click to view the settings of the selected profile.
 Copy	Click to create a copy of the selected profile to the playlist.
 Remove	Click to remove the selected profile from the playlist.

# System Settings

Click the *Settings* link from the Main page for the System Settings to open on the **General** page:

General
User Account
Port Name
Network
EDID
Maintenance
➤

### Serial Settings

Serial Port Mode RS232 Configuration Mode ▼

Serial Port Address 01 ▼      Baud Rate 115200 ▼

### Fan status

35°C



Fan Speed Auto ▼

### Power Status

**Power Board**



OK

**Primary Power**  
400 W(15%used)



OK

**Redundant Power**  
400 W(0%used)



N/A

### Device Info

[BER Test](#)

Device	Model Name	F/W Version	Temperature	Power Consumption								
▼ Video Matrix	VM1600	V3.0.299	--	--								
▼ Input Slot1	VM7814	V1.0.072	25°C	Max.5W								
▶ Output Slot2	--	--	--	--								
▼ Output Slot3	VM8804	V2.1.202	30°C	Max.23W								
<table border="1" style="width: 100%; border-collapse: collapse;"> <tr><td>Port9</td><td style="text-align: center;">✘</td></tr> <tr><td>Port10</td><td style="text-align: center;">✘</td></tr> <tr><td>Port11</td><td style="text-align: center;">✘</td></tr> <tr><td>Port12</td><td style="text-align: center;">✘</td></tr> </table>					Port9	✘	Port10	✘	Port11	✘	Port12	✘
Port9	✘											
Port10	✘											
Port11	✘											
Port12	✘											
▼ Output Slot4	VM8514	V2.1.205	28°C	Max.13W								
<table border="1" style="width: 100%; border-collapse: collapse;"> <tr><td>Port13</td><td style="text-align: center;">✘</td></tr> <tr><td>Port14</td><td style="text-align: center;">✘</td></tr> <tr><td>Port15</td><td style="text-align: center;">✘</td></tr> <tr><td>Port16</td><td style="text-align: center;">✘</td></tr> </table>					Port13	✘	Port14	✘	Port15	✘	Port16	✘
Port13	✘											
Port14	✘											
Port15	✘											
Port16	✘											

### System Time

Date(Y/M/D): 2018 / 02 / 01      Time: 14 : 23      [Edit](#)

### Other

Language English ▼

Save
Cancel

- ◆ The *General* page allows you to configure the system serial port, fan, and baud rate, and also view the fan temperature, power unit status, and slot information.
- ◆ The *User Account* page allows you to add and edit user accounts.
- ◆ The *Port Name* page allows you to name each input and output port.
- ◆ The *Network* page allows configuration of the network settings.
- ◆ The *EDID* page is used to set the EDID modes.
- ◆ The *Maintenance* page is for upgrading the device's firmware.
- ◆ The *IR/RS-232 Channel* page allows you to set the IR and RS-232 channel settings\*.
- ◆ The *OSD/CEC* page allows users to control port OSD and CEC settings.
- ◆ Click **Profile List** to return to the Main page.

---

**Note:** The *IR/RS-232 Channel* page is only available when VM7514 / VM8514 I/O boards are installed in the VM1600A.

---



## General

The *General* page has three sections: Serial Settings, Fan Status, Power Status, Device Info and Other.

General
User Account
Port Name
Network
EDID
Maintenance
⌵

**Serial Settings**

Serial Port Mode RS232 Configuration Mode

Serial Port Address 01      Baud Rate 115200

**Fan status**

35°C



Fan Speed Auto

**Power Status**

**Power Board**



OK

**Primary Power**  
400 W(15%used)



OK

**Redundant Power**  
400 W(0%used)



N/A

**Device Info** BER Test

Device	Model Name	F/W Version	Temperature	Power Consumption								
▼ Video Matrix	VM1600	V3.0.299	--	--								
▼ Input Slot1	VM7814	V1.0.072	25°C	Max.5W								
▶ Output Slot2	--	--	--	--								
▼ Output Slot3	VM8904	V2.1.202	30°C	Max.23W								
<table border="1" style="border-collapse: collapse; width: 100%;"> <tr><td>Port9</td><td style="text-align: center;">✘</td></tr> <tr><td>Port10</td><td style="text-align: center;">✘</td></tr> <tr><td>Port11</td><td style="text-align: center;">✘</td></tr> <tr><td>Port12</td><td style="text-align: center;">✘</td></tr> </table>					Port9	✘	Port10	✘	Port11	✘	Port12	✘
Port9	✘											
Port10	✘											
Port11	✘											
Port12	✘											
▼ Output Slot4	VM8514	V2.1.205	28°C	Max.13W								
<table border="1" style="border-collapse: collapse; width: 100%;"> <tr><td>Port13</td><td style="text-align: center;">✘</td></tr> <tr><td>Port14</td><td style="text-align: center;">✘</td></tr> <tr><td>Port15</td><td style="text-align: center;">✘</td></tr> <tr><td>Port16</td><td style="text-align: center;">✘</td></tr> </table>					Port13	✘	Port14	✘	Port15	✘	Port16	✘
Port13	✘											
Port14	✘											
Port15	✘											
Port16	✘											

**System Time**

Date(Y/M/D): 2018 / 02 / 01
Time: 14 : 23
[Edit](#)

**Other**

Language English

Save

Cancel

## Serial Settings

- ◆ Use the *Serial Port Mode* drop-down menu to select a signal for the serial port: **RS232 Configuration Mode**, **RS232 Control Mode**, and **RS422/RS485**.
  - ◆ **RS232 Configuration Mode** allows the user to configure VM1600A's system.
  - ◆ **RS232 Control Mode** allows the user to control remote devices that are connected to VM1600A through its RS232 channels. To enable this feature, select the **RS232 Control Mode** and configure the input to output settings. For details, see *IR/RS-232 Channel*, page 105.
  - ◆ If you are using **RS422/RS485**, define the Serial Port Address using the drop-down list.
- ◆ Serial Port Address: Defines the serial port address.
- ◆ Baud rate: Defines the baud rate for the serial port.

## Fan Status

This section displays the internal temperature and status of the cooling fans. Fans rotate to indicate they are working.

---

**Note:** If the fans have stopped working or are switched off, they will appear as follows. The fan module will then need to be replaced or reset.

---



## Power Status

This section displays the status and percentage used of the Primary and Redundant Power units.

## Device Info

This section provides the following device information:

- ◆ The model name, firmware version, temperature, and power consumption of the Modular Matrix Switch and the connected input/output boards
- ◆ The port connection status of the plugged-in input/output boards

- ◆ Cable quality analysis using the **BER Test** button commands.

**Note:**

- ◆ BER Test is only applicable to the following cable connections:
  - ◆ VM7814 with its source device
  - ◆ VE816R with VM8514
- ◆ To test the quality of the cable connecting the VM7814 input board and its source device, unplug the cable from the source device and plug it into the corresponding port on the VM8814 output board, and then click the **BER Test** button to start the test. For example, if a cable plugs into port 1 of a VM7814 board, the other end should be plugged into port 1 of the VM8814 board before you start the test.
- ◆ To test the quality of all the cables connected to the Modular Matrix Switch, click **BER Test**.

Device Info BER Test

Device	Model Name	FW Version	Temperature	Power Consumption
▼ Video Matrix	VM1600	V3.0.299	--	--
▼ Input Slot1	VM7814	V1.0.072	25°C	Max.5W

- ◆ To test the quality of a specific cable, click **BER Test** button next to the cable.

▼ Output Slot4	VM8514	V2.1.205	28°C	Max.13W
Port13	VE805R	V2.1.205	✘	BER Test
Port14	N/A	N/A	✘	
Port15	N/A	N/A	✘	
Port16	N/A	N/A	✘	

## System Time

This section displays the Modular Matrix Switch's time and date in the format of year-month-day. Click **Edit** to change the settings.

## Other

Use the **Language** drop-down menu to select a preferred user interface language.

## User Account

The *User Account* page lets you add, edit, or delete users and change the password for accessing the VM1600A’s GUI.

---

**Note:** This is an Administrator only function.

---

User Name	Level	Description
administrator	Administrator	Default_User
user_1	Basic User	User_Account

- ◆ **Add account** – Click the *Add account* button to add another user to the list. The VM1600A supports up to 32 users and up to 16 concurrent logins (see page 88 for more details).
- ◆ **Edit** – Click the *Edit* button to change user information. This option allows an Administrator to edit individual accounts.

User Name	Level	Description	
<a href="#">Edit</a> 111111	Administrator	111111	
<a href="#">Edit</a> 12345	Administrator		
<a href="#">Edit</a> administrator	Administrator	Default_user	

- ◆ **Edit** – Rename the user account, set the password, add a description, and set the user’s permission level (see page 90 for more details).
- ◆ **Delete** – Removes the user account.



- ◆ The default username and password are: administrator/password.

## Add Account

Use the Add Account / Edit buttons to create a user account, set the user's password, add a description, and set the user's permission level (see , page 89) when accessing the VM1600A's GUI.

- ◆ Fill in a username or edit an existing one.
- ◆ Enter a password and re-type the password to confirm.

---

**Note:** Usernames and passwords accept multi-lingual characters, and must be 5–16 alphanumeric characters (excluding ;=[]+=/?\|). Passwords are case sensitive. Usernames only support lower case letters.

---

- ◆ Add or edit the description for the user.
- ◆ Select the permission level that you want to grant the user (see , page 89).
- ◆ Click **Create User** to save the data.
- ◆ Click **Cancel** to discard the changes and exit.
- ◆ If a user is logged into the VM1600A's GUI, their user settings cannot be edited, and the fields in this screen are grayed out.

## Permission Level

At the bottom of the New/Edit User page is the permission section, which is used to set a user's permission level.

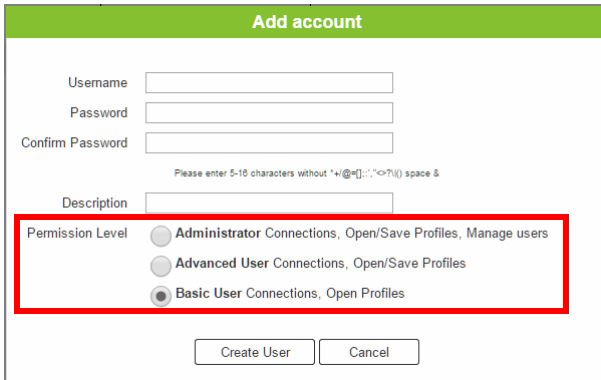

The screenshot shows a web form titled "Add account" with a green header. The form contains several input fields: "Username", "Password", "Confirm Password", and "Description". Below the "Confirm Password" field is a note: "Please enter 5-16 characters without '\*+!@#[]:;,<?>|() space &". The "Permission Level" section is highlighted with a red box and contains three radio button options: "Administrator Connections, Open/Save Profiles, Manage users", "Advanced User Connections, Open/Save Profiles", and "Basic User Connections, Open Profiles". At the bottom of the form are two buttons: "Create User" and "Cancel".

The three available permission levels are as follows:

- ◆ **Administrator** – this level provides full access and control of the VM1600A, in addition to full User Management privileges.
- ◆ **Advanced User** – this level provides full access and control with no User Management privileges.
- ◆ **Basic User** – this level only provides basic functions (connections and open profiles).

## Port Name

The *Annotation* page lets users name the Input and Output ports for easy identification.

Output Port		Input Port	
Port1	<input type="text" value="01_Port_Out_1"/>	Port1	<input type="text" value="01_Port_In_1"/>
Port2	<input type="text" value="02_Port_Out_2"/>	Port2	<input type="text" value="02_Port_In_2"/>
Port3	<input type="text" value="03_Port_Out_3"/>	Port3	<input type="text" value="03_Port_In_3"/>
Port4	<input type="text" value="04_Port_Out_4"/>	Port4	<input type="text" value="04_Port_In_4"/>
Port5	<input type="text" value="05_Port_Out_5"/>	Port5	<input type="text" value="05_Port_In_5"/>
Port6	<input type="text" value="06_Port_Out_6"/>	Port6	<input type="text" value="06_Port_In_6"/>
Port7	<input type="text" value="07_Port_Out_7"/>	Port7	<input type="text" value="07_Port_In_7"/>
Port8	<input type="text" value="08_Port_Out_8"/>	Port8	<input type="text" value="08_Port_In_8"/>
Port9	<input type="text" value="09_Port_Out_9"/>	Port9	<input type="text" value="09_Port_In_9"/>
Port10	<input type="text" value="10_Port_Out_10"/>	Port10	<input type="text" value="10_Port_In_10"/>
Port11	<input type="text" value="11_Port_Out_11"/>	Port11	<input type="text" value="11_Port_In_11"/>
Port12	<input type="text" value="12_Port_Out_12"/>	Port12	<input type="text" value="12_Port_In_12"/>
Port13	<input type="text" value="13_Port_Out_13"/>	Port13	<input type="text" value="13_Port_In_13"/>
Port14	<input type="text" value="14_Port_Out_14"/>	Port14	<input type="text" value="14_Port_In_14"/>
Port15	<input type="text" value="15_Port_Out_15"/>	Port15	<input type="text" value="15_Port_In_15"/>
Port16	<input type="text" value="16_Port_Out_16"/>	Port16	<input type="text" value="16_Port_In_16"/>

- ◆ To name an Input/Output port, enter a descriptive name of up to 16 characters (including 0-9, a-z, A-Z, \_, -) in the corresponding field.
- ◆ To change an Input/Output port's name, enter another value and click **Save**.
- ◆ Click **Reset** to clear all stored names.

---

**Note:** The Input and Output port names can be the same.

---

## Network

The *Network* page lets you configure the VM1600A's IP settings for connecting to it via the web GUI, and enable/disable Telnet.

DHCP	<input type="radio"/> Enable	<input checked="" type="radio"/> Disable
IP Address	<input type="text"/>	
Subnet Mask	<input type="text"/>	
Default Gateway	<input type="text"/>	
Website Timeout	<input type="text" value="5 min"/>	
MAC Address	00:10:74:AE:01:70	
Telnet	<input checked="" type="radio"/> Enable	<input type="radio"/> Disable

**Enable** DHCP to allow the DHCP server to assign an IP address to the VM1600A. Select **Disable** to enter your own static IP address settings for the device.

Click **Reset** to use the following default values:

- ◆ IP Address – **192.168.0.60**
- ◆ Subnet Mask – **255.255.255.0**
- ◆ Default Gateway – **192.168.0.1**
- ◆ Website Timeout\* – N/A, 5, 10, 30, 60 minutes
- ◆ Telnet Configuration enabled (checked)

Enter the values, then click **Save**. Changes may take a few seconds and after refreshing the page automatically redirects you to the IP address specified.

---

\* This option controls how long an inactive web connection stays logged into the VM1600A. Any changes will take effect immediately. The default setting is 5 minutes.

---



## EDID Settings

The *EDID Setting* page lets users view and select an EDID Mode so that the VM1600A can use the best resolution for its display(s).

EDID Mode	EDID & CEA Description																	
<input checked="" type="radio"/> ATEN Default <input type="radio"/> Port1 Mode <input type="radio"/> Remix <input type="radio"/> Customized <input type="button" value="Apply"/>	<p><b>EDID</b></p> <ol style="list-style-type: none"> <li>Vendor/Product Identification</li> <li>EDID Structure/Revision</li> <li>Basic Display/Feature</li> <li>Color Characteristics</li> <li>Established Timings</li> <li>Standard Timings</li> <li>Detail Timing/Display Description 1</li> <li>Detail Timing/Display Description 2</li> <li>Monitor Description</li> <li>Monitor Description</li> </ol> <p><b>CEA</b></p> <ol style="list-style-type: none"> <li>Display Support</li> <li>Video Data</li> <li>Audio Data</li> <li>Speaker Allocation</li> <li>Vendor Specific Data</li> <li>Detail Timing/Display Description 1</li> <li>Detail Timing/Display Description 2</li> <li>Detail Timing/Display Description 3</li> <li>Detail Timing/Display Description 4</li> <li>Detail Timing/Display Description 5</li> </ol>																	
<p>Port EDID Status</p> <table border="1"> <tr><td>Port 1</td><td>ATEN Default</td></tr> <tr><td>Port 2</td><td>ATEN Default</td></tr> <tr><td>Port 3</td><td>ATEN Default</td></tr> <tr><td>Port 4</td><td>ATEN Default</td></tr> <tr><td>Port 5</td><td>ATEN Default</td></tr> <tr><td>Port 6</td><td>ATEN Default</td></tr> <tr><td>Port 7</td><td>ATEN Default</td></tr> <tr><td>Port 8</td><td>ATEN Default</td></tr> </table>	Port 1	ATEN Default	Port 2	ATEN Default	Port 3	ATEN Default	Port 4	ATEN Default	Port 5	ATEN Default	Port 6	ATEN Default	Port 7	ATEN Default	Port 8	ATEN Default	<p>Model ID: 0x7801            Manufacturer ID: CMO            Serial Number: 0x00000000            Manufacture Date: 2005 Week 13            Week of Manufacture: 13            Year of Manufacture: 2005</p>	
Port 1	ATEN Default																	
Port 2	ATEN Default																	
Port 3	ATEN Default																	
Port 4	ATEN Default																	
Port 5	ATEN Default																	
Port 6	ATEN Default																	
Port 7	ATEN Default																	
Port 8	ATEN Default																	

**Note:** The EDID Mode can also be selected via the Front Panel pushbuttons – see *Operation Mode*, page 49.

Extended Display Identification Data (EDID) is a data format that contains a display's basic information and is used to communicate with the video source/system.

## EDID Mode

In the left panel of the page, users can select a pre-configured EDID Mode using the **EDID Mode** radio buttons.

**EDID Mode**

ATEN Default

Port 1 Mode

Remix

Customized

Port EDID Status

Port 1 ATEN Default

Port 2 ATEN Default

Port 3 ATEN Default

Port 4 ATEN Default

Port 5 ATEN Default

Port 6 ATEN Default

Port 7 ATEN Default

Port 8 ATEN Default

**EDID & CEA Description**

**EDID**

1. Vendor/Product Identification
2. EDID Structure/Revision
3. Basic Display/Feature
4. Color Characteristics
5. Established Timings
6. Standard Timings
7. Detail Timing/Display Description 1
8. Detail Timing/Display Description 2
9. Monitor Description
10. Monitor Description

**CEA**

1. Display Support
2. Video Data
3. Audio Data
4. Speaker Allocation
5. Vendor Specific Data
6. Detail Timing/Display Description 1
7. Detail Timing/Display Description 2
6. Detail Timing/Display Description 3
7. Detail Timing/Display Description 4
6. Detail Timing/Display Description 5

Model ID: 0x7801

Manufacturer ID: CMO

Serial Number: 0x00000000

Manufacture Date: 2005 Week 13

Week of Manufacture: 13

Year of Manufacture: 2005

Select the EDID Mode to use and click **Apply**. The VM1600A uses the settings configured for that EDID mode.

Options are:

- ◆ **ATEN Default:** All ports' EDID are the same as the hardware default EDID.
- ◆ **Port 1 Mode:** All ports' EDID are the same as Port1's EDID.
- ◆ **Remix:** All ports' EDID use the best display resolution.
- ◆ **Customized:** See Customized Mode, see page 96.

## EDID & CEA Description

The right panel of the screen lets users view the configuration of the *EDID* and *CEA* Modes selected:

**EDID Mode**

ATEN Default  
 Port1 Mode  
 Remix  
 Customized

Apply

**Port EDID Status**

Port 1	ATEN Default
Port 2	ATEN Default
Port 3	ATEN Default
Port 4	ATEN Default
Port 5	ATEN Default
Port 6	ATEN Default
Port 7	ATEN Default
Port 8	ATEN Default

**EDID & CEA Description**

**EDID**

1. Vendor/Product Identification
2. EDID Structure/Revision
3. Basic Display/Feature
4. Color Characteristics
5. Established Timings
6. Standard Timings
7. Detail Timing/Display Description 1
8. Detail Timing/Display Description 2
9. Monitor Description
10. Monitor Description

**CEA**

1. Display Support
2. Video Data
3. Audio Data
4. Speaker Allocation
5. Vendor Specific Data
6. Detail Timing/Display Description 1
7. Detail Timing/Display Description 2
6. Detail Timing/Display Description 3
7. Detail Timing/Display Description 4
6. Detail Timing/Display Description 5

Model ID: 0x7801  
 Manufacturer ID: CMO  
 Serial Number: 0x00000000  
 Manufacture Date: 2005 Week 13  
 Week of Manufacture: 13  
 Year of Manufacture: 2005

- ◆ From the left column, click the option that you want to view and/or edit. There are two categories: **EDID** (Extended Display Identification Data) and **CEA** (Consumer Electronics Association).
- ◆ When you highlight the menu items on the left column, the right column displays the current settings for the corresponding EDID configuration. Some of the screens are read-only.
- ◆ See *EDID Settings*, page 93 for more information on these two columns.

## Customized Mode

Use the *Customized* Mode to automatically retrieve and save the EDID settings of a connected monitor/display device to an input source port.

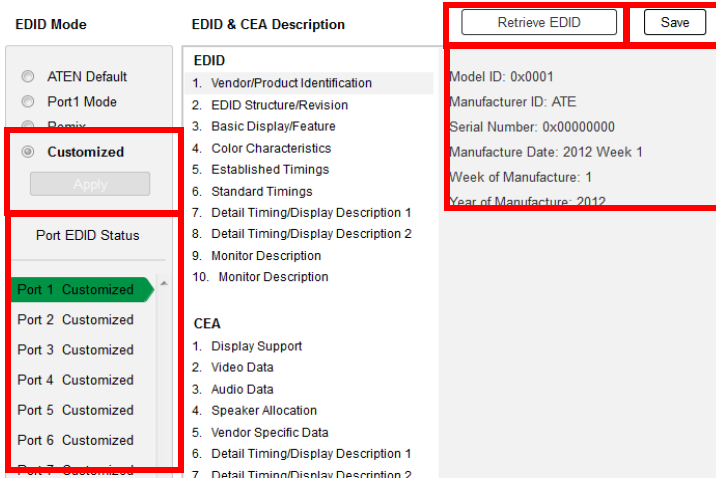

- ◆ In the left-most panel of the page, select **Customized** from the *EDID Mode* section and click **Apply**.
- ◆ **Port EDID Status**: Select which input source port you want to store the EDID configuration (01–16).
- ◆ **Retrieve EDID**: Click and a pop-up window appears to retrieve the EDID settings of a stored EDID configuration: *Customized EDID 01-16, Display Port* or *ATEN Default*. Select the port to retrieve:

### Caution

Select a port to retrieve.

- ◆ The right panel displays a summary of the acquired EDID settings that you can edit. Click **Save** and select the configuration for the **Current Port** or **All Ports** for the duration of the session.

### Save

Save changes to the current port or all ports?

## Customized EDID Parameters

The EDID structure is comprised of 128 bytes in total – each heading shown in the left column corresponds to a specific number of bytes.

The pages for the pre-configured EDID Modes (Port 1, Default and Remix) cannot be edited. The pages for the Customized EDID, which can be edited, are discussed in the proceeding sections:

## Established Timings

This page lists video resolutions/timings that display devices can support.

The screenshot shows a web interface for configuring EDID parameters. On the left, under 'EDID Mode', 'Customized' is selected. The main area is titled 'EDID & CEA Description'. Under the 'EDID' section, '5. Established Timings' is selected. A list of video resolutions and refresh rates is displayed with checkboxes. A red box highlights this list. At the bottom of the list are 'Clear' and 'Select All' buttons. The 'CEA' section is also visible below.

Resolution/Refresh Rate	Selected
<input type="checkbox"/> 720x400 @ 70Hz	
<input type="checkbox"/> 720x400 @ 88Hz	
<input checked="" type="checkbox"/> 640x480 @ 60Hz	
<input checked="" type="checkbox"/> 640x480 @ 67Hz	
<input checked="" type="checkbox"/> 640x480 @ 72Hz	
<input checked="" type="checkbox"/> 640x480 @ 75Hz	
<input checked="" type="checkbox"/> 800x600 @ 56Hz	
<input checked="" type="checkbox"/> 800x600 @ 60Hz	
<input checked="" type="checkbox"/> 800x600 @ 72Hz	
<input checked="" type="checkbox"/> 800x600 @ 75Hz	
<input type="checkbox"/> 832x624 @ 75Hz (Apple Macintosh II)	
<input type="checkbox"/> 1024x768 @ 87Hz, interlaced(1024*768) E	
<input checked="" type="checkbox"/> 1024x768 @ 60Hz	
<input checked="" type="checkbox"/> 1024x768 @ 70Hz	
<input checked="" type="checkbox"/> 1024x768 @ 75Hz	
<input checked="" type="checkbox"/> 1280x1024 @ 75Hz	
<input type="checkbox"/> 1152x870 @ 75Hz(Apple Macintosh II)	

- ◆ Select the resolution(s) you want to use for the attached monitor/display device.
- ◆ Click **Clear All** to deselect all the items.
- ◆ Click **Select All** to check all the items.
- ◆ Click **Save** to apply the changes.

## Standard Timings

This page shows eight resolutions/timings that display devices can support in addition to those listed in the Established Timings page.

EDID Mode:  ATEN Default  Port1 Mode  Remix  Customized

Port EDID Status: Port 1 Customized, Port 2 Customized, Port 3 Customized, Port 4 Customized, Port 5 Customized, Port 6 Customized, Port 7 Customized, Port 8 Customized

EDID & CEA Description: Retrieve EDID, Save

H Active Pixel	V Active Pixel	R Refresh Rate	Aspect Ratio
H 256	V 160	R 61	16:10
H 256	V 160	R 61	16:10
H 256	V 160	R 61	16:10
H 256	V 160	R 61	16:10
H 256	V 160	R 61	16:10
H 256	V 160	R 61	16:10
H 256	V 160	R 61	16:10
H 256	V 160	R 61	16:10

CEA: 1. Display Support, 2. Video Data, 3. Audio Data, 4. Speaker Allocation, 5. Vendor Specific Data, 6. Detail Timing/Display Description 1, 7. Detail Timing/Display Description 2, 8. Detail Timing/Display Description 3, 9. Detail Timing/Display Description 4, 10. Detail Timing/Display Description 5

- ◆ Select the *H Active Pixel* from the drop-down menu.
- ◆ Select the *Aspect Ratio* from the drop-down menu.
- ◆ Click **Save** to apply the changes.

## Detail Timing / Display Description

This screen gives more video resolution options, and provides resolution/timing details.

EDID Mode:  ATEN Default  Port1 Mode  Remix  Customized

Port EDID Status: Port 1 Customized, Port 2 Customized, Port 3 Customized, Port 4 Customized, Port 5 Customized, Port 6 Customized, Port 7 Customized, Port 8 Customized

EDID & CEA Description: Retrieve EDID, Save

Resolution: [Dropdown Menu]

Stereo Display: Interfaced: Non-interfaced, Stereo Mode: none, Sync type: Digital Separate, Positive Vsync Polarity: yes, Positive Hsync Polarity: yes

	Horizontal	Vertical
Image Size:	mm	mm
Active P/L:	pixel	lines
Blanking Time:	pixel	lines
Sync Offset:	pixel	lines
Sync Width:	pixel	lines
Border:	pixel	lines

CEA: 1. Display Support, 2. Video Data, 3. Audio Data, 4. Speaker Allocation, 5. Vendor Specific Data, 6. Detail Timing/Display Description 1, 7. Detail Timing/Display Description 2, 8. Detail Timing/Display Description 3, 9. Detail Timing/Display Description 4, 10. Detail Timing/Display Description 5

In the drop down menu, choose a resolution with values that fit the attached monitor/display device and click Save.

## Monitor Description

This screen lets you specify the viewing specifications, namely horizontal and vertical scan ranges and pixel clock rate, of your monitor/display device.

**EDID Mode**

ATEN Default

Port1 Mode

Remix

**Customized**

Port EDID Status

**Port 1 Customized**

Port 2 Customized

Port 3 Customized

Port 4 Customized

Port 5 Customized

Port 6 Customized

Port 7 Customized

Port 8 Customized

**EDID & CEA Description**

**EDID**

1. Vendor/Product Identification
2. EDID Structure/Revision
3. Basic Display/Feature
4. Color Characteristics
5. Established Timings
6. Standard Timings
7. Detail Timing/Display Description 1
8. Detail Timing/Display Description 2
9. Monitor Description
10. Monitor Description

**CEA**

1. Display Support
2. Video Data
3. Audio Data
4. Speaker Allocation
5. Vendor Specific Data
6. Detail Timing/Display Description 1
7. Detail Timing/Display Description 2
8. Detail Timing/Display Description 3
9. Detail Timing/Display Description 4
10. Detail Timing/Display Description 5

	Minutes	~	Max
Horizontal Scan Range:	15	~	102
Vertical Scan Range:	23	~	121
Pixel Clock Rate: (MHz)	80		(10~2550)

Enter the values that correspond to your device and click **Save** to apply the changes.

## CEA Settings

CEA is an extension data of the EDID structure, which further extends the standard definitions of EDID to support advanced features of monitors/display devices.

### Display Support

This screen describes the display's basic digital components.

The screenshot shows a configuration interface for EDID and CEA settings. On the left, under 'EDID Mode', there are radio buttons for 'ATEN Default', 'Port1 Mode', 'Remix', and 'Customized' (which is selected). Below these is an 'Apply' button and a 'Port EDID Status' section listing 'Port 1 Customized' through 'Port 8 Customized'. The main area is titled 'EDID & CEA Description' and contains two columns. The left column lists EDID items 1 through 10, with 'Display Support' highlighted under the 'CEA' section. The right column shows 'Revision: 0x03', 'Underscan: no', and 'Basic Audio: yes'. Below this, the 'YCbCr' section has two checked options: 'YCbCr444' and 'YCbCr422', which are enclosed in a red rectangular box. At the top right of the main area are 'Retrieve EDID' and 'Save' buttons.

Select the YCbCr mode applicable to your display and click **Save**.



## Video Data

This screen lists additional video resolution/timing displays that may be supported by other devices, other than PC monitors (for example, 1080i).

The screenshot shows the 'EDID & CEA Description' configuration page. On the left, under 'EDID Mode', the 'Customized' radio button is selected. The 'Port EDID Status' section shows 'Port 1. Customized' as the active port. The main area is titled 'EDID & CEA Description' and contains two lists: 'EDID' and 'CEA'. The 'EDID' list includes items like 'Vendor/Product Identification' and 'Video Data', which is currently selected. The 'CEA' list includes 'Display Support' and 'Video Data'. To the right, there is a 'Native' dropdown menu showing '1280 x 720p @ 59.94/60Hz 16:9'. Below it is a 'Resolution:' section with a 'Multiple selection(maximum 18)items' list. This list contains several resolution options, with the first five checked: '640 x 480p @ 59.94/60Hz 4:3', '720 x 480p @ 59.94/60Hz 4:3', '720 x 480p @ 59.94/60Hz 16:9', '1280 x 720p @ 59.94/60Hz 16:9', and '1920 x 1080i @ 59.94/60Hz 16:9'. A 'Clear' button is located at the bottom right of the resolution list.

- ◆ Select the native resolution of the attached display device.
- ◆ Select the resolutions that work with the attached monitor/display device.
- ◆ Click **Clear All** to deselect all the items.
- ◆ Click **Save** to apply the changes.

## Audio Data

This screen lets you select advanced audio configurations for your device.

The screenshot shows the 'Audio Data' configuration interface. On the left, under 'EDID Mode', 'Customized' is selected and 'Port 1' is highlighted. The main area is divided into 'EDID' and 'CEA' sections. The 'EDID' section lists 10 items, with 'Audio Data' (item 3) selected. A red box highlights the 'Audio Format' section, which contains six dropdown menus. 'Audio Format 1' is currently set to 'Linear PCM 2-channel'. 'Retrieve EDID' and 'Save' buttons are visible at the top right.

Use the drop down menu to select the **Audio Format** (1~6) applicable to your audio output device, and click **Save** to apply the changes.

## Detail Timing / Display Description

This screen gives more video resolution options, and provides resolution/timing details (in addition to those specified in the EDID structure).

The screenshot shows the 'Detail Timing / Display Description' configuration interface. The 'Resolution' dropdown menu is highlighted with a red box and shows 'Pixel Clock(MHz): 148.50'. Below it, the 'Stereo Display' section is visible with settings like 'Interlaced: Non-interlaced', 'Stereo Mode: none', 'Sync type: Digital Separate', 'Positive Vsync Polarity: yes', and 'Positive Hsync Polarity: yes'. The 'Resolution Detail' table is also present.

	Horizontal	Vertical
Image Size :	mm	mm
Active PXL :	pixel	lines
Blanking Time:	pixel	lines
Sync Offset :	pixel	lines
Sync Width:	pixel	lines
Border:	pixel	lines

In the **Resolution** drop down menu, choose a resolution with values that fit the attached monitor/display device and click **Save**.

## Maintenance

The *Maintenance* page lets users upgrade the VM1600A's firmware and back up or restore system settings. This is an Administrator only function.

### Firmware upgrade

Upgrade    Browse    Select a firmware file to begin

### Backup / Restore

\*User accounts cannot be backed up or restored.

Backup

Restore    Browse    Select a restore file to begin

To upgrade the VM1600A's firmware, do the following:

1. Use the **Browse** button to locate the firmware upgrade file. Make sure you have the correct file saved on your PC.
2. Click **Upgrade** to begin the upgrade procedure.

---

**Note:** After updating the firmware, it's recommended that you clear your web browser's cache and then close and reopen the web browser. This will ensure the GUI refreshes and functions properly.

---

To back up the VM1600A's system settings, do the following:

1. Click **Backup**. A configuration file will then begin downloading.

To restore the VM1600A's system settings, do the following:

1. Use the **Browse** button to locate the configuration file. Make sure you have the correct file saved on your PC.
2. Click **Restore** to begin the restoration procedure.

---

**Note:** User accounts cannot be backed up or restored.

---

## VE805R / VE816R Firmware Upgrade

To upgrade the VE805R / VE816R from a computer, do the following:

1. Download the firmware upgrade package from the ATEN website.
2. Connect a computer to the VE805R / VE816R's RS-232 port.

3. Power on the VE805R / VE816R and turn its Firmware Upgrade switch to ON.
4. Reset the VE805R / VE816R's power to enter firmware upgrade mode. The HDMI Out LED blinks orange every second to indicate the device is in F/W upgrade mode.
5. At this point you can run the firmware upgrade package from the computer connected to the VE805R / VE816R.

## IR/RS-232 Channel

The *IR/RS-232 Channel* page is available for VM7514 and VM8514 boards only. The options allow you to set ports to use **Local IR/RS-232** which will direct the board to use the local IR and RS-232 port signals, or **HDBaseT IR/RS-232** which will direct the board to use the HDBaseT port for the IR and RS-232 signals for control.

Use **Loopback** for the IR/RS-232 signals to be sent back to local source or local display device connected to the same port on the same I/O board. This allows you to use the IR/RS-232 connection to control devices locally. Loopback prevents the IR/RS-232 signals from being sent across the connection to another I/O board. The Loopback setting is good when you use a VM8514 board to extend displays but use a different board type (not VM7514) for input devices and want to use the IR/RS-232 signals for local control.

**RS232 Channel**

RS232 Return Path     Connection Path

In-Board		Connection Follow Video Path	Out-Board	
Port	Apply to All		Port	Apply to All
Port 1	Local RS232		Port 1	Local RS232
Port 2	Local RS232		Port 2	Local RS232
Port 3	Local RS232		Port 3	Local RS232
Port 4	Local RS232		Port 4	Local RS232
Port 5	Local RS232		Port 5	Local RS232
Port 6	Local RS232		Port 6	Local RS232
Port 7	Local RS232		Port 7	Local RS232
Port 8	Local RS232		Port 8	Local RS232
Port 9	Local RS232		Port 9	Local RS232
Port 10	Local RS232		Port 10	Local RS232
Port 11	Local RS232		Port 11	Local RS232
Port 12	Local RS232		Port 12	Local RS232
Port 13	Local RS232		Port 13	Local RS232
Port 14	Local RS232		Port 14	Local RS232
Port 15	Local RS232		Port 15	Local RS232
Port 16	Local RS232		Port 16	Local RS232
Board	Broadcast (1-All)			

**RS232 Command-line**

HEX

- ◆ **In-Board:** Set each input port to use the *Local IR/RS-232*, *HDBaseT IR/RS-232*, or *Loopback* setting for the IR/RS-232 signals.
  - ◆ **Port:** Applies an option to all ports.
  - ◆ **Port 1 ~ Port 16:** Applies different options to each individual port.
  - ◆ **Board:**
    - ◆ **Broadcast (1-All):** Controls all the connected devices simultaneously.
    - ◆ **Manual:** Controls specified devices simultaneously. Click **Edit** to select devices.
- ◆ **RS-232 Command Line:** Use this setting to remotely control a connected device via RS-232 commands.
- ◆ **Connection:** Sets the connection path for the IR/RS-232 signals.
  - ◆ Use the drop-down menu to select *Follow Video Path* to have the IR/RS-232 signal use the same connection path as the profile settings.
  - ◆ Use the drop-down menu to select *Broadcast (1-All)* to broadcast the IR/RS-232 signal from one port to all ports. Use the drop-down menu that appears to select the port that broadcasts the IR/RS-232 signal.
- ◆ **Out-Board:** Set each output port to use the *Local IR/RS-232*, *HDBaseT IR/RS-232*, or *Loopback* setting for the IR/RS-232 signals.
  - ◆ Use the drop-down menu to apply an option to all ports; or select *Local IR/RS-232*, *HDBaseT IR/RS-232* or *Loopback* for individual ports.

---

**Note:** By default the RS-232 Return Path will use the lowest port number available for a connection. This setting can not be changed.

---

## Video

The Video settings page allows you to set Seamless Switch™ options which determine how a display performs when the Input port is changed.

Port	*Seamless Switch	Transition	Period	Scale Resolution
	Apply to All	Apply to All	Apply to All	Apply to All
Port1	<input checked="" type="checkbox"/> ON	<input type="checkbox"/> OFF	Normal	1920x1080@60Hz(720)
Port2	<input checked="" type="checkbox"/> ON	<input type="checkbox"/> OFF	Normal	1920x1080@60Hz(720)
Port3	<input checked="" type="checkbox"/> ON	<input type="checkbox"/> OFF	Normal	1920x1080@60Hz(720)
Port4	<input checked="" type="checkbox"/> ON	<input type="checkbox"/> OFF	Normal	1920x1080@60Hz(720)
Port5	<input checked="" type="checkbox"/> ON	<input type="checkbox"/> OFF	Normal	1920x1080@60Hz(720)
Port6	<input checked="" type="checkbox"/> ON	<input type="checkbox"/> OFF	Normal	1920x1080@60Hz(720)
Port7	<input checked="" type="checkbox"/> ON	<input type="checkbox"/> OFF	Normal	1920x1080@60Hz(720)
Port8	<input checked="" type="checkbox"/> ON	<input type="checkbox"/> OFF	Normal	1920x1080@60Hz(720)
Port9	<input checked="" type="checkbox"/> ON	<input type="checkbox"/> OFF	Normal	1920x1080@60Hz(720)
Port10	<input checked="" type="checkbox"/> ON	<input type="checkbox"/> OFF	Normal	1920x1080@60Hz(720)
Port11	<input checked="" type="checkbox"/> ON	<input type="checkbox"/> OFF	Normal	1920x1080@60Hz(720)
Port12	<input checked="" type="checkbox"/> ON	<input type="checkbox"/> OFF	Normal	1920x1080@60Hz(720)
Port13	<input checked="" type="checkbox"/> ON	<input type="checkbox"/> OFF	Normal	1920x1080@60Hz(720)
Port14	<input checked="" type="checkbox"/> ON	<input type="checkbox"/> OFF	Normal	1920x1080@60Hz(720)
Port15	<input checked="" type="checkbox"/> ON	<input type="checkbox"/> OFF	Normal	1920x1080@60Hz(720)
Port16	<input checked="" type="checkbox"/> ON	<input type="checkbox"/> OFF	Normal	1920x1080@60Hz(720)

\*Seamless switch can not be turned off at video wall editor

### Note:

When Seamless Switch™ is enabled:

- ◆ The *Transition*, *Period* and *Scale Resolution* options can be enabled.
- ◆ Video outputs will not display 3D, Deep Color, or interlace (i.e., 1080i) resolutions correctly. To use these features, first disable Seamless Switch™.
- ◆ Videos may not display within range (fit on the screen), in which case, make sure to adjust the display settings on your device.

Enable Seamless Switch™ to remove the video distortion and delay seen when an input port is switched. Use the drop-down menu to apply options to all ports, or the On/Off button to enable/disable Seamless Switch™ per port. With Seamless Switch™ enabled, the following options are made available:

- ◆ **Transition:** Allows you to fade the video display when the Input port is changed. Use the period option to set the fade speed.
  - ◆ Use the drop-down menu to apply options to all ports, or On/Off button to enable/disable Transition per port.
- ◆ **Period:** Sets the fade speed for the Transition option.

- ◆ Use the drop-down menu to apply an option (*Slow*, *Normal*, or *Fast*) to all ports, or lower drop-down menus to apply options per port.
- ◆ **Scale Resolution:** Forces the port to scale the video displayed to the selected resolution.
- ◆ Use the top drop-down menu to apply an option to all ports, or lower drop-down menus to apply options per port.



## HDCP

The *HDCP* page lets users view and set HDCP key settings between input and output ports for digital copy protection and to ensure Seamless Switch™ is used between different devices. This is an Administrator and Advanced User only function.

**HDCP Configuration**

**Input**

Port Apply to All ▼

---

Port 1 All Ports HDCP 1.4 ▼

Port 2 All Ports HDCP 1.4 ▼

Port 3 All Ports HDCP 1.4 ▼

Port 4 All Ports HDCP 1.4 ▼

**Connection**

— Connection Path

**Output**

Port Apply to All ▼

---

Port 1  Fix HDCP

Port 2  Fix HDCP

Port 3  Fix HDCP

Port 4  Fix HDCP

### Connection

Here users can find a visual display of connection paths between inputs and outputs. When selecting an input, its path is displayed in green.

### Output

Here users can define whether or not HDCP settings are fixed, either by individual port or by applying one setting to all ports. By prearranging and fixing keys, this setting ensures that Seamless Switch™ is possible even when switching between HDCP and non-HDCP enabled devices.

## **OSD/CEC**

The OSD/CEC page lets users view and set OSD and CEC settings for all ports.

OSD / CEC

Port	OSD	CEC
	<input type="button" value="Apply to All"/>	<input type="button" value="Apply to All"/>
Port1	<input checked="" type="radio"/> ON	<input type="radio"/> OFF
Port2	<input checked="" type="radio"/> ON	<input type="radio"/> OFF
Port3	<input checked="" type="radio"/> ON	<input type="radio"/> OFF
Port4	<input checked="" type="radio"/> ON	<input type="radio"/> OFF

- ◆ **OSD:** Sets the default OSD option for the port. When OSD is on, real-time text updates appear on the display for 10 seconds when configuration and port changes are made to its output.
  - ◆ Use the drop-down menu to apply options to all ports, or ON/OFF button to enable/disable the OSD for each port.
- ◆ **CEC:** Consumer Electronics Control (CEC) allows interconnected HDMI devices to communicate and respond to one remote control.
  - ◆ Use the drop-down menu to apply options to all ports, or On/Off button to enable/disable CEC for a port.
- ◆ Click **Save** to save the settings or **Cancel** to exit without saving the settings.

---

## Telnet Operation

---

The VM1600A can be operated and configured via a remote terminal session using Telnet.

To log into the VM1600A by means of a Telnet session, do the following:

1. On your computer, open a terminal (command line) session.
2. At the prompt, key in the VM1600A's IP address in the following way:  

```
telnet [IP address]:23
```
3. Press **Enter**. The login screen appears. At the login prompt, provide your Username and Password.

---

**Note:** If a user logs on using a Username that is already in session, the newest login takes effect and the previous session is replaced.

---

### Configuration Menu

Once a Telnet connection to the VM1600A is established, the device's text-based Configuration Menu comes up, with the following items:

#### **1. H – Call up the command list for help**

Command list:

IP – Set IP address

LO – Load connections from profile *nn*

PW – Change password

RI – Read what input is connected to *nn* output

RO – Read what output is connected to *nn* input

SB – Set the serial port baud rate

SS – Switch input to specified port

SV – Save the current connections into profile *nn*

TI – Set timeout

VR – Software version information

Ctrl-Q – Quit

## 2. IP – Set IP address

IP

Old IP address: 192.168.0.60

New IP address:

## 3. LO – Load connections from profile

LO 01

Load profile 01 OK.

## 4. PW – Change password

PW

Old password: \*\*\*\*\*

New password:

## 5. RI – Read what input is connected to *nn* output

RI 01

Input port 02 04 08 is connected to output port 01

## 6. RO – Read what output is connected to *nn* input

RO 01

Output port 02 is connected to input port 01

## 7. SB – Set serial port baud rate

SB 96

Serial port baud rate is set to 9600

## 8. SS – Switch input to specified output

SS 01, 03

Switch input 01 to output 03 (00: Local Port)

## 9. SV – Save the current connections into a profile

SV 01

Save the current connections into profile 01

## 10. TI – Set timeout

TI 30

Set 30 minute timeout

## 11. VR – Software version information

VR

Software version 1.0.

---

### Note:

- ◆ All RS-232 commands in this manual are also applicable in Telnet mode. For details on RS-232 commands, see Chapter 5, *RS-232 Commands*.
  - ◆ For further information about these functions, refer to the corresponding sections earlier in this chapter.
-

This Page Intentionally Left Blank

# Chapter 5

## RS-232 Commands

### Serial Control Protocol Commands

---

The VM1600A's built-in bi-directional RS-232 serial interface allows system control through a high-end controller or PC.

### RS-232 Pin Assignment

Pin	Description	Pin	Description
1	Not connected	6	Not connected
2	RXD	7	Not connected
3	TXD	8	Not connected
4	Not connected	9	Not connected
5	GND		

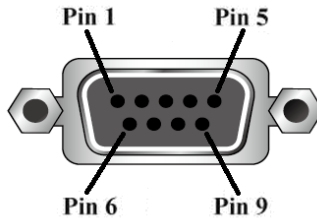

### Configuring the Serial Port

The controller's serial port should be configured as follows:

Parameter	Setting
Baud Rate	19200
Data Bits	8
Parity	None
Stop Bits	1
Flow Control	None

## **RS-422 / RS-485**

In the sections that follow the formulas that include an “address” command are for RS-422 and RS-485 serial port devices when the VM1600A is set up in cascade installation.

### **Verification**

After entering a command, a verification message appears at the end of the command line as follows:

- ♦ **Command OK** - indicates that the command is correct and successfully performed by the switch
- ♦ **Command incorrect** - indicates that the command has the wrong format and/or values.



## Switch Port Command

The formula for Switch commands is as follows:

**Switch Command + Input + Num1 + Output + Num2 + Address + Num3 + Stream + Control [Enter]**

1. For example, to switch input port 02 to output port 05, type the following:  
**sw i02 o05 [Enter]**
2. To switch output port 04 to the next port, input the following:  
**sw o04 + [Enter]**
3. To turn off video output on port 03, type the following:  
**sw o03 off [Enter]**
4. To turn off video output on port 03 on device 02, type the following:  
**sw o03 a02 off [Enter]**

The following tables show the possible values for the **Switch Port** command

Command	Description
sw	Switch command
Input	Description
i	Input port command
Num1	Description
xx	Input port xx: 01~16
*	All input ports
Output	Description
o	Output port command
Num2	Description
yy	Output port yy: 01~16
*	All output ports
Address	Description
a	Device address command (RS-422 and RS-485 only)

Num3	Description
zz	Device address zz: 01~16 (default is 01) (RS-422 and RS-485 only)
*	All devices

Stream	Description
Video	Switch Video Channel Only
Audio	Switch Stereo Audio Channel Only
All	Switch Video Channel and Stereo Audio Channel Default Select if been omitted

Control	Description
on	Turn on the display
off	Turn off the display
+	Next Port
-	Previous Port

---

**Note:** By default, input port 01 is tied to output port 01; input port 02 is tied to output port 02; and so on until port 08 (i.e., o01 i01, o02 i02... o16 i16)

---

The following table shows the available command list:

Command	Input	Input Port	Output	Output Port	Address	Device No.	Stream	Control	Enter	Description
sw	i	xx *	o	yy *	a	zz *	video audio all		[Enter]	Switch Input Port xx to Output Port yy on address zz xx:01~16, * yy:01~16, * zz: 01~16, *
sw			o	yy *	a	zz *	video audio all	on off	[Enter]	Turn on Output Port yy Turn off Output Port yy on address zz yy:01~16, * zz: 01~16, *
sw			o	yy *	a	zz *	video audio all	+ -	[Enter]	Switch Next Input to Output Port yy Switch Previous Input to Output Port yy yy:01~16, *

**Note:** 1. Each command string can be separated with a space.

2. The **Address** command is for RS-422/485 only. If the address parameter is missing from RS-422/485 commands, the default **a00** will be used. Skip the address for RS-232 commands.
3. The **Port Number** and **Address** command strings can be skipped, and the default value will be used.

## **Mute Command**

Mute allows you to enable or disable an output port's audio. The Mute command will turn on/off the HDMI audio and stereo audio. When the HDMI audio is off, the stereo's volume can be adjusted using the volume command.

The formula for the Mute command is as follows:

**Command + Output + Num1 + Address + Num2 + Control + [Enter]**

1. For example, to mute the audio on output port 03, type the following:  
**mute o03 on [Enter]**
2. To turn mute off on all output ports, type the following:  
**mute o\* off [Enter]**
3. To mute the audio for output port 09 on device 03, type the following:  
**mute o09 a03 on [Enter]**

The following tables show the possible values for the **Mute** command:

<b>Command</b>	<b>Description</b>
mute	Mute command

<b>Output</b>	<b>Description</b>
o	Output port command

<b>Num1</b>	<b>Description</b>
xx	Output port number xx: 01~16 (default is 01)
*	All output ports

<b>Address</b>	<b>Description</b>
a	Device address command (RS-422 and RS-485 only)

<b>Num2</b>	<b>Description</b>
zz	Device address zz: 01~16 (default is 01) (RS-422 and RS-485 only)
*	All devices

<b>Control</b>	<b>Description</b>
on	Mute on; audio on output port is disabled

Control	Description
off	Mute off; audio on output port is enabled (default)

- Note:**
1. Each command string can be separated with a space.
  2. The **Address** command is for RS-422/485 only. If the address parameter is missing from RS-422/485 commands, the default **a00** will be used. Skip the address for RS-232 commands.
  3. Skip the **Output** command to mute or enable the audio of all output ports.

The following table shows the available command list:

Command	Output	Num1	Address	Num2	Control	Enter	Description
mute	o	xx *	a	zz *	on	[Enter]	Mute audio for output port xx, on device zz xx:01~16, * zz: 01~16,*
mute	o	xx *	a	zz *	off	[Enter]	Turn mute off for output port xx, on device zz xx:01~16, * zz: 01~16,*

## Volume Command

The volume command adjusts the stereo volume for an output port.

The formula for the Volume command is as follows:

**Command + Output + Num1 + Address + Num2 + Volume + Control + [Enter]**

1. For example, to adjust the volume for output port 06 to level 14, type the following:

**volume o06 v14 [Enter]**

2. To adjust the volume for all output ports to level 04, type the following:

**volume o\* v04 [Enter]**

3. For example, to adjust the volume for output port 06 on device 01 to level 14, type the following:

**volume o06 a01 v14 [Enter]**

The following tables show the possible values for the **Volume** command:

Command	Description
volume	Volume command

Output	Description
o	Output port command

Num1	Description
xx	Output port xx: 01~16 (default is 01)
*	All output ports

Address	Description
a	Device address command (RS-422 and RS-485 only)

Num2	Description
yy	Device address yy: 01~16 (default is 01) (RS-422 and RS-485 only)
*	All devices

Volume	Description
v	Volume level command

Control	Description
zz	Audio volume level zz: 01~10 (default is 10)

- Note:** 1. Each command string can be separated with a space.
2. The **Address** command is for RS-422/485 only. If the address parameter is missing from RS-422/485 commands, the default **a00** will be used. Skip the address for RS-232 commands.

The following table shows the available command list:

Command	Out put	Num1	Address	Num2	Vol- ume	Control	Enter	Description
volume	o	xx *	a	yy *	v	zz	[Enter]	Adjust volume for output port xx, on device yy, to level zz xx:01~16, * yy: 01~16,* zz: 01~16,*

## **Save/Load Profile Commands**

The Save/Load Profile command allows you to save the current connection configuration as a profile and load connection profiles.

The formula for Save/Load Profile commands is as follows:

**Command + Profile + Num1 + Address + Num2 + Control + [Enter]**

1. For example, to save the current connection configuration as profile 08, type the following:

**profile f08 save [Enter]**

2. To load connection profile 04, type the following:

**profile f04 load [Enter]**

3. To save the current connection configuration of device 03 as profile 08, type the following:

**profile f08 a03 save [Enter]**

The following tables show the possible values for commands:

Command	Description
profile	Save / Load Profile command

Profile	Description
f	Profile command

Num1	Description
xx	Profile number xx: 01-32 (default is 01)

Address	Description
a	Device address command (RS-422 and RS-485 only)

Num2	Description
yy	Device address yy: 01~16 (default is 01) (RS-422 and RS-485 only)
*	All devices

Control	Description
save	Save the current connection configuration



Control	Description
load	Load a saved profile

- Note:**
1. Each command string can be separated with a space.
  2. The **Address** command is for RS-422/485 only. If the address parameter is missing from RS-422/485 commands, the default **a00** will be used. Skip the address for RS-232 commands.
  3. If the **Address** or **Profile** parameter is skipped the default value will be used.

The following table shows the available command list:

Command	Profile	Num1	Address	Num2	Control	Enter	Description
profile	f	xx	a	yy *	save	[Enter]	Save current connection configuration on device yy as profile xx xx:01~16 yy: 01~16,*
profile	f	xx	a	yy *	load	[Enter]	Load profile xx on device yy xx:01~16 yy: 01~16,*

## **EDID Mode Command**

Extended Display Identification Data (EDID) is data that contains a display's basic information and is used to communicate with the video source. The EDID Mode commands allow you to change the EDID setting.

The formula for the EDID command is as follows:

**Command + Address + Number + Control + [Enter]**

1. For example, for port 06 to use the remix EDID mode, type:

**edid a06 remix [Enter]**

1. For example, to use Port1 EDID mode for all devices, type:

2. **edid a\* port1 [Enter]**

The following tables show the possible values for the **EDID** command:

<b>Command</b>	<b>Description</b>
edid	EDID command

<b>Address</b>	<b>Description</b>
a	Device address command (RS-422 and RS-485 only)

<b>Number</b>	<b>Description</b>
zz	Device address zz: 01~16 (default is 01) (RS-422 and RS-485 only)
*	All devices

<b>Control</b>	<b>Description</b>
port1	Implement the EDID of the connected display to Port 1, and pass it to the video source.
remix	Implement the EDID of each connected display according to its connection when the VM1600A is first powered on, or immediately after selecting the Remix option.
default	Implements ATEN's default EDID. (default)
custom	Implements the customized mode as set in the EDID system settings. (See <i>Customized Mode</i> , page 96)

- 
- Note:** 1. Each command string can be separated with a space.
2. The **Address** command is for RS-422/485 only. If the address parameter is missing from RS-422/485 commands, the default **a00** will be used. Skip the address for RS-232 commands.
- 

The following table lists the available EDID commands:

Command	Address	Num	Control	Enter	Description
edid	a	zz *	port1	[Enter]	The EDID from Port 1 is passed to the video source. zz: 01~16
edid	a	zz *	remix	[Enter]	The VM1600A implements the EDID of each connected display according to its connection when the device is first powered on, or immediately after selecting the Remix option.
edid	a	zz *	default	[Enter]	ATEN's default EDID is passed to the video source.
edid	a	zz *	custom	[Enter]	Implements the customized mode.

## **CEC Command**

Consumer Electronics Control (CEC) allows interconnected HDMI devices to communicate with and respond to the same remote control.

The formula for the CEC command is as follows:

**Command + Output + Number + Control + [Enter]**

1. For example, to enable the CEC function on output port 1, type:  
**cec o01 on [Enter]**

The following tables show the possible values for the CEC command:

<b>Command</b>	<b>Description</b>
cec	CEC command
<b>Output Command</b>	<b>Description</b>
o	Output port command
<b>Number</b>	<b>Description</b>
yy	Output port 01~16 port (default is 01)
*	All output ports
<b>Control</b>	<b>Description</b>
off	Disable CEC (default)
on	Enable CEC

---

**Note:** Each command string can be separated with a space.

---

The following table lists the available CEC commands:

<b>Command</b>	<b>Output Port</b>	<b>Control</b>	<b>Enter</b>	<b>Description</b>
cec	yy *	off	[Enter]	CEC off for output port yy (default) (yy:01~16, *)
cec	yy *	on	[Enter]	CEC on for output port yy (yy:01~16, *)

## Read Command

The Read command allows you to view information about the devices.

The formula for the Read command is as follows:

**Command + Address + Number + [Enter]**

- To view information, type:

**read [Enter]**

- To view information about device 02, type:

**read a02 [Enter]**

The following table shows the possible values for the **Read** command:

Command	Description
read	Read command
Address	Description
a	Device address command (RS-422 and RS-485 only)
Number	Description
zz	Device address zz: 01~16 (default is 01) (RS-422 and RS-485 only)
*	All Devices

**Note:** The **Address** command is for RS-422/485 only. If the address parameter is missing from RS-422/485 commands, the default **a00** will be used. Skip the address for RS-232 commands.

The following table lists the available Read commands:

Command	Address	Num	Enter	Description
read	a	zz *	[Enter]	View information about device number zz: 01~16

### DVI/HDMI Example:

read Command OK

o01 i03 video on i06 audio v10 HDMI-A on 1080p

o02 i04 video off i06 audio off HDMI-A off bypass

o03 i02 video on i06 audio v10 HDMI-A off 1600

How to read the commands:

1. o01 i03 video on i06 audio v10 HDMI-a on 1080p  
**Output 01** is connected to **Input 03** with **video on**; **audio** is **on** from **Input 06** with **volume 10** using the **HDMI** audio source; the resolution is scaled to **1080p**
2. o01 i03 video on i06 audio v10 1080p  
**Output 01** is connected to **Input 03** with **video on**; **audio** is on with **volume 10**; the resolution is scaled to **1080p**
3. o02 i04 video off i06 audio off HDMI-a off bypass  
**Output 02** is connected to **Input 04** with **video off**; **audio** is **off** from **Input 06** using the **HDMI** audio source; scaling is **bypassed** (turned off)

## Reset Command

The Reset command allows you to reset the VM1600A back to the default factory settings. Reset includes resetting the device's IP address.

The formula for the Reset command is as follows:

**Command + Address + Number + [Enter]**

- To reset the VM1600A, type:

**reset [Enter]**

- To reset device 02, type:

**reset a02 [Enter]**

The following tables show the possible values for the **Reset** command:

Command	Description
reset	Reset command

Address	Description
a	Device address command (RS-422 and RS-485 only)

Device Number	Description
zz	Device address zz: 01~16 (default is 01) (RS-422 and RS-485 only)
*	All Devices

**Note:** 1. Each command string can be separated with a space.

- The **Address** command is for RS-422/485 only. If the address parameter is missing from RS-422/485 commands, the default **a00** will be used. Skip the address for RS-232 commands.

The following table lists the available Reset commands:

Command	Address	Num	Enter	Description
reset	a	zz *	[Enter]	Resets the device settings Address; zz: 01~16 (RS-422 and RS-485 only)

## **Baud Rate Command**

The Baud Rate command allows you to set the RS-232 data rate for the VM1600A to use. Options are 9600, 19200 (default) 38400 and 115200.

The formula for the Baud Rate command is as follows:

**Command + Control + [Enter]**

1. For example, to set 38400 as the baud rate, type:

**baud 38400 [Enter]**

The following tables show the possible values for the **Baud Rate** command:

<b>Command</b>	<b>Description</b>
baud	Sets the RS-232 baud rate

<b>Control</b>	<b>Description</b>
9600	Use 9600 baud rate
19200	Use 19200 baud rate
38400	Use 38400 baud rate
115200	Use 115200 baud rate

---

**Note:** Each command string can be separated with a space.

---

The following table lists the available Baud Rate commands:

<b>Command</b>	<b>Control</b>	<b>Enter</b>	<b>Description</b>
baud	9600 / 19200 / 38400 / 115200	[Enter]	Sets the baud rate



## OSD Command

To enable or disable the On-Screen Display (OSD) for displays, use the following command:

**Command + Output + Number + Control + [Enter]**

- For example, to enable the OSD for output 07, type:  
**osd o07 on [Enter]**
- For example, to disable the OSD for all outputs, type:  
**osd o\* off [Enter]**

The following tables show the possible values for the **OSD** command:

Command	Description
osd	OSD command

Output	Description
o	Output port command

Number	Description
yy	Output port 01~16 port (default is 01)
*	All output ports

Control	Description
on	Enable OSD function
off	Disable OSD function (default)

**Note:** Each command string can be separated with a space.

The following table lists the available OSD commands:

Command	Output Port	Control	Enter	Description
osd	yy *	on	[Enter]	OSD on for output yy yy:01~16, *
osd	yy *	off	[Enter]	CEC off for output yy (default) yy:01~16, *

## Echo Command

The Echo function updates the RS-232 controller when operations are made via the front panel pushbuttons, web browser or telnet. The changes echo back to the RS-232 controller to keep the settings in sync with the device.

The formula for the Echo command is as follows:

**Command + Control + [Enter]**

1. For example, to enable the echo feature, type:

**echo on [Enter]**

The following tables show the possible values for the **Echo** command:

Command	Description
echo	Echo command

Control	Description
on	Turns Echo function on
off	Turns Echo function off (default)

---

**Note:** Each command string can be separated with a space.

---

The following table lists the available Echo commands:

Command	Control	Enter	Description
echo	on	[Enter]	Turn on Echo function
echo	off	[Enter]	Turn off Echo function

## Scaling Command

The Scaling command allows you to set a resolution for scaling the display connected to an output port.

The formula for the Scaling command is as follows:

**Command + Output + Number 1 + Address + Number 2 + Horizontal Resolution + Number 3+ Vertical Resolution + Number 4 + Frequency + Number 5 + Control + [Enter]**

1. For example, to turn scaling off for output port 02, type:  
**scaling o02 off [Enter]**
2. To set the scaling for output port 04 to 1920x1080@60Hz, type:  
**scaling o04 1080p [Enter]**
3. To set the scaling for all output ports on all devices to the connected display's native resolution, type:  
**scaling o\* a\* native [Enter]**

The following tables show the possible values for the **Scaling** command:

Command	Description
scaling	Scaling command

Output	Description
o	Output command

Num1	Description
yy	Output port yy: 01~16 (default is 01)
*	All output ports

Address	Description
a	Device address command (RS-422 and RS-485 only)

Num2	Description
zz	Device Address zz: 01~16 (RS-422 and RS-485 only)
*	All Devices

Horizontal Resolution	Description
hor	Horizontal resolution command for scaling

Resolution Number	Description
hhhh	Horizontal resolution

Vertical Resolution	Description
ver	Vertical resolution command for scaling

Resolution Number	Description
vvvv	Vertical resolution

Frequency	Description
freq	Frequency command for scaling

Frequency Number	Description
fff	Frequency resolution

Horizontal Resolution	Description
hor	Horizontal resolution command for scaling

Control	Description
off	Turn off the scaling function (by pass mode)
native	Map display's native resolution for scaling (default)

- 
- Note:** 1. Each command string can be separated with a space.
2. The **Address** command is for RS-422/485 only. If the address parameter is missing from RS-422/485 commands, the default **a00** will be used. Skip the address for RS-232 commands.

3. The **Port Number** command string can be skipped, and the default value will be used.

The following table lists the available Scaling commands:

Com	Out	N1	Add	N2	Horizontal Res	N3	Vertical Res	N4	Frequency	N5	Cont	Enter	Description
scaling	o	yy*	a	zz*	hor		ver		freq		off	[Enter]	Turn off scaling for output yy device zz (by pass mode) yy: 01~16 or * zz: 01~16 or *
scaling	o	yy*	a	zz*	hor		ver		freq		native	[Enter]	Enable display's native resolution for scaling on output yy device zz (default) yy: 01~16 or * zz: 01~16 or *
scaling	o	yy*	a	zz*	hor	1920	ver	1080	freq	60		[Enter]	Scale output yy device zz to 1920x1080@60Hz yy: 01~16 or * zz: 01~16 or *
scaling	o	yy*	a	zz*	hor	1280	ver	720	freq	60		[Enter]	Scale output yy device zz to 1280x720@60Hz yy: 01~16 or * zz: 01~16 or *

Com	Out	N1	Add	N2	Horizontal Res	N3	Vertical Res	N4	Frequency	N5	Cont	Enter	Description
scaling	o	yy*	a	zz*	hor	1920	ver	1200	freq	60		[Enter]	Scale output port yy device zz to 1920x1200@60Hz yy: 01~16 or * zz: 01~16 or *
scaling	o	yy*	a	zz*	hor	1600	ver	1200	freq	60		[Enter]	Scale output yy device zz to 1600x1200@60Hz yy: 01~16 or * zz: 01~16 or *
scaling	o	yy*	a	zz*	hor	1400	ver	1050	freq	60		[Enter]	Scale output yy device zz to 1400x1050@60Hz yy: 01~16 or * zz: 01~16 or *
scaling	o	yy*	a	zz*	hor	1280	ver	1024	freq	60		[Enter]	Scale output yy device zz to 1280x1024@60Hz yy: 01~16 or * zz: 01~16 or *
scaling	o	yy*	a	zz*	hor	1024	ver	768	freq	60		[Enter]	Scale output yy device zz to 1024x768@60Hz yy: 01~16 or * zz: 01~16 or *

## **Fan Speed Command**

The Fan Speed command allows you to set the VM1600A's internal fan speed.

To set the fan speed, use the following command:

**Command + Control + [Enter]**

1. For example, to set the fan to auto detect, type:

**fan auto [Enter]**

The following tables show the possible values for the **Fan Speed** command:

Command	Description
fan	Fan Speed Command

Control	Description
low	Set internal fan to low speed
mid	Set internal fan to normal speed
high	Set internal fan to high speed
auto	Set internal fan to auto detect (default)

---

**Note:** Each command string can be separated with a space.

---

The following table lists the available Fan Speed commands:

Command	Control	Enter	Description
fan	low	[Enter]	Sets fan speed to low
fan	mid	[Enter]	Sets fan speed to normal
fan	high	[Enter]	Sets fan speed to high
fan	auto	[Enter]	Sets fan speed to auto detect (default)

## **Alert Command**

To trigger a warning when issues arise for a specific input port, use the following command:

**Command + Input + Number + Control + [Enter]**

For example, to enable the basic Alert function for input port 1, type:

**alert i01 m1 [enter]**

The following tables show the possible values for the **Alert** command:

<b>Command</b>	<b>Description</b>
alert	Alert command
<b>Input</b>	<b>Description</b>
i	Input command
<b>Port number</b>	<b>Description</b>
yy	01-04 port
<b>Control</b>	<b>Description</b>
off	Disable Alert (default)
m1	Show basic Alert (flashing border)
m2	Show detailed Alert (flashing border and port information)

---

**Note:** Each command string can be separated with a space.

---

The following table lists the available Alert commands:

<b>Command</b>	<b>Input Command</b>	<b>Input Port</b>	<b>Control</b>	<b>Enter</b>	<b>Description</b>
alert	i	yy	off	[Enter]	Alert off for input port yy (yy:01~04)
alert	i	yy	m1	[Enter]	Basic Alert on for input port yy (yy:01~04)
alert	i	yy	m2	[Enter]	Detailed Alert on for input port yy (yy:01~04)

---



## **FrameSync Command**

The FrameSync command allows you enable or disable the Frame Synchronization function on the VM1600A.

**Note:** This feature is only supported by VM8814.

The formula for the Frame Synchronization command is as follows:

**Command + Control + [Enter]**

For example, to enable the Frame Synchronization function, type:

**frsync on [Enter]**

The following tables show the possible values for the **FrameSync** command:

<b>Command</b>	<b>Description</b>
frsync	Frame Synchronization command

<b>Control</b>	<b>Description</b>
off	Turn off the Frame Synchronization function
on	Turn on the Frame Synchronization function

**Note:** Each command string can be separated with a space.

The following table lists the available FrameSync commands:

<b>Command</b>	<b>Control</b>	<b>Enter</b>	<b>Description</b>
frsync	off	[Enter]	Turn off the Frame Synchronization function
frsync	on	[Enter]	Turn on the Frame Synchronization function

## **Long Reach Mode Command**

Long Reach Mode allows you to extend the maximum transmission distance to 150m.

**Note:** This feature is only supported by VM8514.

The formula for the Long Reach Mode command is as follows:

**Command + Output<port\_number> + Control + [Enter]**

For example, to enable Long Reach Mode for port 1 on the output board, type the following:

**vslongreach o01 on [Enter]**

The following tables show the possible values for the **Long Reach Mode** command:

<b>Command</b>	<b>Description</b>
vslongreach	Long Reach Mode command

<b>Control</b>	<b>Description</b>
off	Turn off Long Reach Mode for all output ports
on	Turn on Long Reach Mode for the specified output port

---

**Note:** Each command string can be separated with a space.

---

The following table lists the available Long Reach Mode commands:

<b>Command</b>	<b>Output Port</b>	<b>Control</b>	<b>Enter</b>	<b>Description</b>
vslongreach	o	off	[Enter]	Turn off Long Reach Mode
vslongreach		on	[Enter]	Turn on Long Reach Mode

## Safety Instructions

---

### General

- ◆ Read all of these instructions. Save them for future reference.
- ◆ Follow all warnings and instructions marked on the device.
- ◆ This product is for indoor use only.
- ◆ Do not place the device on any unstable surface (cart, stand, table, etc.). If the device falls, serious damage will result.
- ◆ Do not use the device near water.
- ◆ Do not place the device near, or over, radiators or heat registers.
- ◆ The device cabinet is provided with slots and openings to allow for adequate ventilation. To ensure reliable operation, and to protect against overheating, these openings must never be blocked or covered.
- ◆ The device should never be placed on a soft surface (bed, sofa, rug, etc.) as this will block its ventilation openings. Likewise, the device should not be placed in a built in enclosure unless adequate ventilation has been provided.
- ◆ Never spill liquid of any kind on the device.
- ◆ Unplug the device from the wall outlet before cleaning. Do not use liquid or aerosol cleaners. Use a damp cloth for cleaning.
- ◆ The device should be operated from the type of power source indicated on the marking label. If you are not sure of the type of power available, consult your dealer or local power company.
- ◆ The device is designed for IT power distribution systems with 230V phase-to-phase voltage.
- ◆ To prevent damage to your installation it is important that all devices are properly grounded.
- ◆ The device is equipped with a 3-wire grounding type plug. This is a safety feature. If you are unable to insert the plug into the outlet, contact your electrician to replace your obsolete outlet. Do not attempt to defeat the purpose of the grounding-type plug. Always follow your local/national wiring codes.
- ◆ Do not allow anything to rest on the power cord or cables. Route the power cord and cables so that they cannot be stepped on or tripped over.

- ◆ If an extension cord is used with this device make sure that the total of the ampere ratings of all products used on this cord does not exceed the extension cord ampere rating. Make sure that the total of all products plugged into the wall outlet does not exceed 15 amperes.
- ◆ To help protect your system from sudden, transient increases and decreases in electrical power, use a surge suppressor, line conditioner, or un-interruptible power supply (UPS).
- ◆ Position system cables and power cables carefully; Be sure that nothing rests on any cables.
- ◆ Never push objects of any kind into or through cabinet slots. They may touch dangerous voltage points or short out parts resulting in a risk of fire or electrical shock.
- ◆ Do not attempt to service the device yourself. Refer all servicing to qualified service personnel.
- ◆ If the following conditions occur, unplug the device from the wall outlet and bring it to qualified service personnel for repair.
  - ◆ The power cord or plug has become damaged or frayed.
  - ◆ Liquid has been spilled into the device.
  - ◆ The device has been exposed to rain or water.
  - ◆ The device has been dropped, or the cabinet has been damaged.
  - ◆ The device exhibits a distinct change in performance, indicating a need for service.
  - ◆ The device does not operate normally when the operating instructions are followed.
- ◆ Only adjust those controls that are covered in the operating instructions. Improper adjustment of other controls may result in damage that will require extensive work by a qualified technician to repair.
- ◆ Avoid circuit overloads. Before connecting equipment to a circuit, know the power supply's limit and never exceed it. Always review the electrical specifications of a circuit to ensure that you are not creating a dangerous condition or that one does not already exist. Circuit overloads can cause a fire and destroy equipment.

## **Rack Mounting**

- ◆ Before working on the rack, make sure that the stabilizers are secured to the rack, extended to the floor, and that the full weight of the rack rests on the floor. Install front and side stabilizers on a single rack or front stabilizers for joined multiple racks before working on the rack.
- ◆ Always load the rack from the bottom up, and load the heaviest item in the rack first.
- ◆ Make sure that the rack is level and stable before extending a device from the rack.
- ◆ Do not overload the AC supply branch circuit that provides power to the rack. The total rack load should not exceed 80 percent of the branch circuit rating.
- ◆ Make sure that all equipment used on the rack – including power strips and other electrical connectors – is properly grounded.
- ◆ Ensure that proper airflow is provided to devices in the rack.
- ◆ Ensure that the operating ambient temperature of the rack environment does not exceed the maximum ambient temperature specified for the equipment by the manufacturer.
- ◆ Do not step on or stand on any device when servicing other devices in a rack.

## Technical Support

---

### International

- ◆ For online technical support – including troubleshooting, documentation, and software updates: **<http://eservice.aten.com>**
- ◆ For telephone support, see *Telephone Support*, page iii:

### North America

Email Support		<a href="mailto:support@aten-usa.com">support@aten-usa.com</a>
Online Technical Support	Troubleshooting Documentation Software Updates	<a href="http://www.aten-usa.com/support">http://www.aten-usa.com/support</a>
Telephone Support		1-888-999-ATEN ext 4988

When you contact us, please have the following information ready beforehand:

- ◆ Product model number, serial number, and date of purchase.
- ◆ Your computer configuration, including operating system, revision level, expansion cards, and software.
- ◆ Any error messages displayed at the time the error occurred.
- ◆ The sequence of operations that led up to the error.
- ◆ Any other information you feel may be of help.

# Specifications

## VM1600A

Function	VM1600A
Board Input	4 x Slot
Board Output	4 x Slot
<b>Video</b>	
Interfaces	Depends on which I/O board is inserted
Max. Data Rate	15.2 Gbps (3.8 Gbps per lane)
<b>Audio</b>	
Input	Depends on which Input board is inserted
Output	Depends on which Output board is inserted
<b>Control</b>	
RS-232	Connector: 1 x DB-9 Female (Black) Serial Control Pin Configurations: Pin2 = Tx, Pin 3=Rx, Pin 5= Gnd Baud Rate and Protocol: Baud Rate:19200, Data Bits:8, Stop Bits:1, Parity: No, Flow Control: No
RS-485/RS-422	Connector: 1 x Captive Screw Connector, 5 Pole
Ethernet	Connector: 1 x RJ-45 Female
<b>EDID Settings</b>	EDID Mode: Default / Port1 / Remix / Customized (EDID Wizard support)
<b>Power</b>	
Connectors	1 x 3-Prong AC Socket
Maximum Input Power Rating	100-240 VAC; 50-60Hz; 6.0A
Consumption	460W (Max.) *A power module can be purchased for power redundancy.
<b>Fan</b>	Airflow: 55.2 cfm Operating Voltage: 10.8 - 13.8 VDC Operating Temp: -10–70°C

<b>Function</b>	<b>VM1600A</b>
<b>Environmental</b>	
Operating Temperature	0–40°C
Storage Temperature	-20–60°C
Humidity	0–80% RH, Non-condensing
<b>Physical Properties</b>	
Housing	Metal
Weight	15.11 kg (33.31 lb)
Dimensions (L x W x H)	48.22 x 46.66 x 26.59 cm (18.98 x 18.37 x 10.47 in.)



**VM7514 / VM8514**

Function	VM7514	VM8514
<b>Video Input</b>		
Interfaces	4 x RJ-45 Female (Silver)	N/A
Impedance	100 $\Omega$	N/A
<b>Video Output</b>		
Interfaces	N/A	4 x RJ-45 Female (Silver)
Impedance	N/A	100 $\Omega$
<b>Video</b>		
Max. Data Rate	10.2 Gbps (3.4 Gbps per lane)	
Max. Pixel Clock	340 MHz	
Compliance	HDBaseT, HDCP 1.4 compatible Consumer Electronics Control (CEC)	
Max. Resolution	4096 x 2160 / 3840 x 2160 @ 60Hz (4:2:0); 4096 x 2160 / 3840 x 2160 @ 30Hz (4:4:4)	
Max. Distance	100 m (Cat 6a)	
<b>Control</b>		
RS-232	4 x Captive Screw Connectors, 3 pole	
IR	4 x Mini Stereo Jack Female (Black)	
<b>Power</b>		
Consumption	24.5W	12.2W
<b>Environmental</b>		
Operating Temperature	0 - 40°C	
Storage Temperature	-20 - 60°C	
Humidity	0 - 80% RH, Non-Condensing	
<b>Physical Properties</b>		
Housing	Metal	
Weight	0.64 kg / 1.41 lb	0.97 kg / 2.14 lb
Dimensions (L x W x H)	35.20 x 23.80 x 2.33 cm / 13.86 x 9.37 x 0.92 in.	

**VM7814 / VM8814**

Function	VM7814	VM8814
<b>Video Input</b>		
Interfaces	4 x HDMI Type A Female (Black)	N/A
Impedance	100 Ω	N/A
Max. Distance	Up to 5m	N/A
<b>Video Output</b>		
Interfaces	N/A	4 x HDMI Type A Female (Black)
Impedance	N/A	100 Ω
Max. Distance	N/A	Up to 15m
<b>Video</b>		
Max. Data Rate	10.2 Gpbs (3.4 Gpbs per Lane)	
Max. Pixel Clock	340 MHz	
Compliance	HDMI (3D, Deep Color, 4K) HDCP 2.2 Compatible Consumer Electronics Control (CEC)	
Max. Resolution	4096 x 2160 / 3840 x 2160 @60Hz (4:2:0) 4096 x 2160 / 3840 x 2160 @30Hz (4:4:4)	
<b>Audio</b>		
Input	4 x Captive Screw Connector, 5 Pole	N/A
Output	N/A	4 x Captive Screw Connector, 5 Pole
Audio Signal Type	stereo, balanced, unbalanced	
<b>Power</b>		
Consumption	4.45W	20W
<b>Environmental</b>		
Operating Temperature	0 - 40°C	
Storage Temperature	-20 - 60°C	
Humidity	0 - 80% RH, Non-Condensing	
<b>Physical Properties</b>		
Housing	Metal	
Weight	0.56 kg / 1.23 lb	
Dimensions (L x W x H)	35.20 x 23.80 x 2.33 cm / 13.86 x 9.37 x 0.92 in.	

**VM7804 / VM8804**

Function	VM7804	VM8804
<b>Video Input</b>		
Interfaces	4 x HDMI Type A Female (Black)	N/A
Impedance	100 $\Omega$	N/A
<b>Video Output</b>		
Interfaces	N/A	4 x HDMI Type A Female (Black)
Impedance	N/A	100 $\Omega$
<b>Video</b>		
Max. Data Rate	6.75 Gpbs (2.25 Gpbs per Lane)	
Max. Pixel Clock	225 MHz	
Compliance	HDMI (3D, Deep Color) HDCP 1.4 Compatible Consumer Electronics Control (CEC)	
Max. Resolution	1920 x 1080	
Max. Distance	15 m	
<b>Audio</b>		
Input	4 x Captive Screw Connector, 5 Pole	N/A
Output	N/A	4 x Captive Screw Connector, 5 Pole
Audio Signal Type	stereo, balanced, unbalanced	
<b>Power</b>		
Consumption	7W	23.13W
<b>Environmental</b>		
Operating Temperature	0 - 40°C	
Storage Temperature	-20 - 60°C	
Humidity	0 - 80% RH, Non-Condensing	
<b>Physical Properties</b>		
Housing	Metal	
Weight	0.58 kg / 1.28 lb	
Dimensions (L x W x H)	35.20 x 23.80 x 2.33 cm / 13.86 x 9.37 x 0.92 in.	

**VM7604 / VM8604**

Function	VM7604	VM8604
<b>Video Input</b>		
Interfaces	4 x DVI-D Female (White)	N/A
Impedance	100 $\Omega$	N/A
<b>Video Output</b>		
Interfaces	N/A	4 x DVI-D Female (White)
Impedance	N/A	100 $\Omega$
<b>Video</b>		
Max. Data Rate	6.75 Gbps (2.25 Gbps per Lane)	
Max. Pixel Clock	225 MHz	
Compliance	HDCP 1.4 Compatible	
Max. Resolution	1920 x 1200	
Max. Distance	5 m	
<b>Audio</b>		
Input	4 x Captive Screw Connector, 5 Pole	N/A
Output	N/A	4 x Captive Screw Connector, 5 Pole
Audio Signal Type	stereo, balanced, unbalanced	
<b>Power</b>		
Consumption	10.62W	20.10W
<b>Environmental</b>		
Operating Temperature	0 - 40°C	
Storage Temperature	-20 - 60°C	
Humidity	0 - 80% RH, Non-Condensing	
<b>Physical Properties</b>		
Housing	Metal	
Weight	0.55 kg / 1.21 lb	
Dimensions (L x W x H)	35.20 x 23.80 x 2.33 cm / 13.86 x 9.37 x 0.92 in.	

**VM7104**

Function	VM7104
<b>Video Input</b>	
Interfaces	4 x HDB-15 Female (Blue)
Impedance	75 $\Omega$
Max. Bandwidth	300 MHz
Max. Resolution	1920 x 1200
Max. Distance	1.8 m
<b>Audio Input</b>	
Interfaces	4 x Captive Screw Connector, 5 Pole
Audio Signal Type	stereo, balanced, unbalanced*
<b>Power</b>	
Consumption	7.1W
<b>Environmental</b>	
Operating Temperature	0 - 40°C
Storage Temperature	-20 - 60°C
Humidity	0 - 80% RH, Non-Condensing
<b>Physical Properties</b>	
Housing	Metal
Weight	0.56 kg / 1.23 lb
Dimensions (L x W x H)	35.20 x 23.80 x 2.33 cm / 13.86 x 9.37 x 0.92 in.

**Note:** The maximum audio input is 0.5 V<sub>rms</sub> (- 6.02 dBV @600 ohm) for balanced audio and 1 V<sub>rms</sub> (0 dBv @600 ohm) for unbalanced audio.

**VM7404**

Function	VM7404
<b>Video Input</b>	
Interfaces	4 x BNC Female
Impedance	75 $\Omega$
<b>Video</b>	
Supported Resolutions	PAL /50 PAL and NTSC/59.94 720p 25, 29.97, 30,50,59.94, 60 1080i 50, 59.94, 60 1080PsF 25, 29.97,30 1080p 23.98, 24, 25, 29.97, 30,50,59.94, 60
Max. Data Rate	2.97 Gpbs
Max. Distance	100m (3G-SDI), 150m (HD-SDI), 300m (SD-SDI)
<b>SDI Formats</b>	3G-SDI, SMPTE-259,292,424, 425 Level A & B-DL
<b>Audio Input</b>	
Interfaces	4 x Captive Screw Connector, 5 Pole
Audio Signal Type	stereo, balanced, unbalanced*
<b>Power</b>	
Consumption	16.0W
<b>Environmental</b>	
Operating Temperature	0 - 40°C
Storage Temperature	-20 - 60°C
Humidity	0 - 80% RH, Non-Condensing
<b>Physical Properties</b>	
Housing	Metal
Weight	0.60 kg / 1.32 lb
Dimensions (L x W x H)	35.20 x 23.80 x 2.33 cm / 13.86 x 9.37 x 0.92 in.

**Note:** The maximum audio input is 0.5 Vrms (- 6.02 dBV @600 ohm) for balanced audio and 1 Vrms (0 dBv @600 ohm) for unbalanced audio.

**VE805R**

Function	VE805R
<b>Video Output</b>	
Interfaces	1 x RJ-45 Female (Silver)
Impedance	100 $\Omega$
<b>Video</b>	
Max. Data Rate	6.75 Gbps (2.25 Gbps per Lane)
Max. Pixel Clock	225 MHz
Compliance	HDMI (3D, Deep Color) HDCP 1.4 Compatible HDBaseT Compatible
Max. Resolutions / Distance	1080p @60m (Cat 5e/6) 1080p @70m (Cat 6a)
<b>Control</b>	
RS-232	1 x Captive Screw Connector, 3 Pole
IR	1 x Mini Stereo Jack Female (Black)
<b>Connectors</b>	
Unit to Unit	1 x RJ-45 Female
<b>Switches</b>	
Firmware Upgrade	1 x Slide Switch
<b>Power</b>	
Connectors	1 x DC Jack (Sliver)
Consumption	5 VDC, 9.5W
<b>Environmental</b>	
Operating Temperature	0 - 50°C
Storage Temperature	-20 - 60°C
Humidity	0 - 80% RH, Non-Condensing
<b>Physical Properties</b>	
Housing	Metal
Weight	0.81 kg / 1.78 lb
Dimensions (L x W x H)	17.74 x 16.92 x 4.20 cm / 6.98 x 6.66 x 1.65 in.

**VE816R**

Function	VE816R
<b>Video Output</b>	
Interfaces	1 x HDMI Type A Female (Black)
Impedance	100 Ω
Max. Distance	Up to 10m
<b>Video</b>	
Max. Data Rate	10.2 Gbps (3.40 Gbps per Lane)
Max. Pixel Clock	340 MHz
Compliance	HDMI (3D, 4K, Deep Color) HDCP 2.2 Compatible HDBaseT Compatible
Max. Resolutions / Distances	Up to 4K @ 70m (Cat 5e/6) Up to 4K @ 100 m (Cat 6a/ATEN 2L-2910 Cat 6) Up to 1080p @ 100m (Cat 5e/6/6a) <b>4K supported:</b> 4096 x 2160 / 3840 x 2160 @ 60Hz (4:2:0) 4096 x 2160 / 3840 x 2160 @ 30Hz (4:4:4)
<b>Control</b>	
RS-232	1 x Terminal Block, 3 pole (Green)
IR	1 x Mini Stereo Jack Female (Black)
<b>Connectors</b>	
Unit to Unit	1 x RJ-45 Female
<b>Switches</b>	
Firmware Upgrade	1 x Slide Switch
<b>Power</b>	
Connectors	1 x DC Jack (Sliver)
Consumption	5 VDC, 9.09W
<b>Environmental</b>	
Operating Temperature	0 - 40°C
Storage Temperature	-20 - 60°C
Humidity	0 - 80% RH, Non-Condensing



Function	VE816R
<b>Physical Properties</b>	
Housing	Metal
Weight	0.67 kg / 1.48 lb
Dimensions with Bracket (L x W x H)	16.80 x 14.69 x 3.00 cm / 6.61 x 5.78 x 1.18 in.
Dimensions w/o Bracket (L x W x H)	16.60 x 12.49 x 2.90 cm / 6.54 x 4.92 x 1.14 in.

### **VM-PWR460**

Function		VM-PWR460
Properties	Input Voltage	100–240VAC
	Power Consumption	Max.Load 460W
	Operating Temp.	0–40°C

### **VM-FAN554**

Function		VM-FAN554
Properties	Air Flow	55.2 cfm
	Operating Voltage	10.8-13.8 VDC
	Operating Temp.	-10–70°C

## Limited Warranty

---

ATEN warrants its hardware in the country of purchase against flaws in materials and workmanship for a Warranty Period of two [2] years (warranty period may vary in certain regions/countries) commencing on the date of original purchase. This warranty period includes the LCD panel of ATEN LCD KVM switches. Select products are warranted for an additional year (see *A+ Warranty* for further details). Cables and accessories are not covered by the Standard Warranty.

### **What is covered by the Limited Hardware Warranty**

ATEN will provide a repair service, without charge, during the Warranty Period. If a product is defective, ATEN will, at its discretion, have the option to (1) repair said product with new or repaired components, or (2) replace the entire product with an identical product or with a similar product which fulfills the same function as the defective product. Replaced products assume the warranty of the original product for the remaining period or a period of 90 days, whichever is longer. When the products or components are replaced, the replacing articles shall become customer property and the replaced articles shall become the property of ATEN.

To learn more about our warranty policies, please visit our website:  
<http://www.aten.com/global/en/legal/policies/warranty-policy/>