

SSR Terminal Block (screwless type)

NEW

■ Features

[Common Feature]

- Selectable between independent and load common output with jumper bar
- High tensile force and easy wiring with one-touch screwless type crimp terminal
- Convenient operating status check with operation indicator (blue LED)
- SSR: [Fujitsu] SN-24A01C
[Omron] 3GMC-202P
[Panasonic] AQG22124, AQG12124, AQZ202D



[1-point]

- Selectable between independent and power common input with jumper bar
- DIN Rail mounting

[4-point]

- Selectable between NPN common and PNP common common input with jumper bar insulating location
- SSR protection with the cover
- Easy SSR replacement with SSR ejector (except ASL-L04ST0-□□)
- DIN Rail or screw mounting

⚠ Please read "Safety considerations" in operation manual before using.



US LISTED

(except ASL-L1ST0-□□, ASL-L4ST0-□□ series)

■ Ordering Information

AS L - L 04 SP0 - U N

AS	L	L	04	SP0	U	N			
						Varistor installation	N	Not installed	
							Y	Installed	
						Input logic	4-point	U	Universal
							1-point	N	NPN
								P	PNP
						SSR type	MP0	AQZ202D (panasonic)	
							SP0	AQG12124 (panasonic)	
							SP1	AQG22124 (panasonic)	
							SR0	G3MC-202P (omron)	
							ST0	SN-24A01C (fujitsu)	
						No. of SSR points	01	1-point	
							04	4-point	
						Connector type	L	Screwless	
							L	Screwless	
						Terminal type	L	Screwless	
							L	Screwless	
						Model	AS	SSR Terminal Block	
							AS	SSR Terminal Block	

■ Crimp Terminal Specification

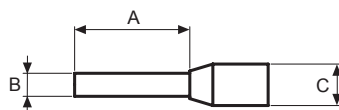

(unit: mm)

	A	B	C	Applicable wire
End Sleeve (ferrule terminal) crimp terminal	10 to 12.0	≤ 2.0	≤ 4.1	AWG22-16 (0.30 to 1.25mm ²) (60°C only)

Specifications

Model	1-point	ASL-L01MP0-□N	ASL-L01SP0-□N	ASL-L01SP1-□N	ASL-L01SR0-□N	ASL-L01ST0-□N
		ASL-L01MP0-□Y	ASL-L01SP0-□Y	ASL-L01SP1-□Y	ASL-L01SR0-□Y	ASL-L01ST0-□Y
	4-point	ASL-L04MP0-UN	ASL-L04SP0-UN	—	—	ASL-L04ST0-UN
		ASL-L04MP0-UY ^{※1}	ASL-L04SP0-UY ^{※1}	—	—	ASL-L04ST0-UY ^{※1}
Power supply	24VDC \pm 10%					
Rated load voltage & current ^{※2}	60VAC \sim /DC \equiv 50/60Hz 2.7A		75-240VAC \sim 50/60Hz 1A	75-240VAC \sim 50/60Hz 2A	24-240VAC \sim 50/60Hz 2A	24-240VAC \sim 50/60Hz 1A
Current consumption ^{※3}	\leq 3mA		\leq 18mA		\leq 10mA	
Output type	1a contact relay output					
Applied SSR	AQZ202D [Panasonic]		AQG12124 [Panasonic]	AQG22124 [Panasonic]	G3MC-202P [Omron]	SN-24A01C [Fujitsu]
Terminal type	Screwless					
Terminal pitch	1-point: 9.0mm (arranging over 2 units)/4-point: 5.0mm					
Operation Indicator	Blue LED					
Applied cable	Solid wire	\varnothing 0.6 to \varnothing 1.25mm (60°C only)				
	Stranded wire ^{※4}	AWG22-16 (0.30 to 1.25mm ²) (60°C only)				
Stripped wire length	8 to 10mm					
Insulation resistance	1-point: \geq 1,000M Ω (at 500VDC megger)/4-point: \geq 1,000M Ω (at 500VDC megger)					
Insulation resistance	Between coil-contact	2,500VAC 50/60Hz for 1 minute				
	Between same contacts ^{※5}	1,000VAC 50/60Hz for 1 minute				
Vibration	Mechanical	0.75mm amplitude at frequency of 10 to 55Hz (for 1 min) in each X, Y, Z direction for 2 hours				
	Malfunction	0.75mm amplitude at frequency of 10 to 55Hz (for 1 min) in each X, Y, Z direction for 10 minutes				
Shock	Mechanical	1,000m/s ² (approx. 100G) in each X, Y, Z direction for 3 times				
	Malfunction	100m/s ² (approx. 10G) in each X, Y, Z direction for 3 times				
Environment	Ambient temp.	-15 to 55°C, storage: -25 to 65°C				
	Ambient humi.	35 to 85%RH, storage: 35 to 85%RH				
Material	Terminal block: polyamide 66, conducting plate: brass, case&base: poly phenylene sulfide					
Accessory	Jumper bar: 1, Ejector: 1 ^{※6}				Jumper bar: 1	
Protection structure	IP20 (IEC standard)					
Approval	CE 					CE
Weight ^{※7}	1-point ^{※8}	Approx. 130g (approx. 19g)	Approx. 134g (approx. 20g)	Approx. 140g (approx. 22g)	Approx. 148g (approx. 24g)	Approx. 136g (approx. 21g)
	4-point	Approx. 118g (approx. 65g)	Approx. 122g (approx. 69g)	Approx. 128g (approx. 75g)	Approx. 128g (approx. 75g)	Approx. 126g (approx. 72g)

- ※1: This is for load protection and it is recommend to use at the inductive load.
- ※2: This is relay load capacity when it is resistive load and temperature characteristic curve is satisfied.
- ※3: The current consumption including LED current by one relay.
- ※4: When using stranded wire, use End Sleeve (ferrule terminal) crimp terminals.
- ※5: ASL-L01□-□Y/ASL-L04□-□Y (varistor installed type), this is 300VAC.
- ※6: Ejector is supplied only for ASL-L04□-□□ (4-point).
- ※7: The weight includes packaging. The weight in parenthesis is for unit only.
- ※8: The weight of 1-point unit is per 4 units with packaging and the weight of parenthesis is per 1.
- ※Environment resistance is rated at no freezing or condensation.

I/O Terminal Blocks

Interface Terminal Block

AFS (screw)
AFL (screwless)
AFR (rising clamp)

Common Terminal Block

ACS (screw)

Sensor Connector Terminal Block

AFE (sensor Connector)

Relay Terminal Block

ABS (screw)

ABL (screwless)

ASL (screwless)

Power Relay (relay terminal block)

SSR (relay terminal block)

I/O Cables

mitsubishi

LSIS

Autonics

RS Automation

YOKOGAWA

FUJI

KDT

OMRON

TELEMECANIQUE

For SERVO

Open Type Cables

Cable Appearance

Remote I/O

ARD (DeviceNet Digital Standard Terminal Type)

ARD (DeviceNet Digital Sensor Connector Type)

ARD (DeviceNet Analog Standard Terminal Type)

ARM (Modbus Digital Sensor Connector Type)

Others

Sensor Connectors

Sockets

Sensor Distribution Boxes

Valve Plugs

Thumbwheel Switches

ASL Series

Dimensions

(unit: mm)

ASL-L01

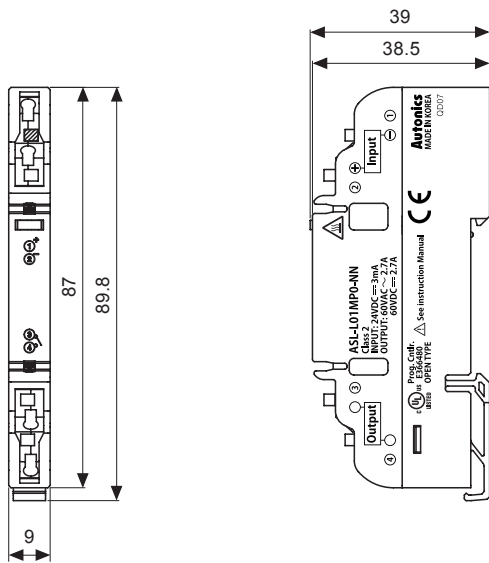

Jumper bar (model: JB-9.0-04L)

※For the desired application (Power/Load common), the jumper bar is sold separately.

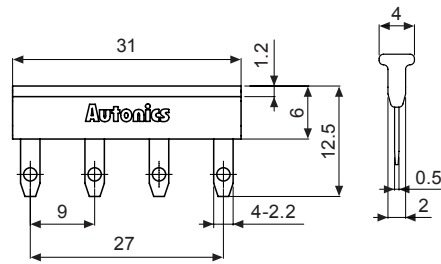

ASL-L04

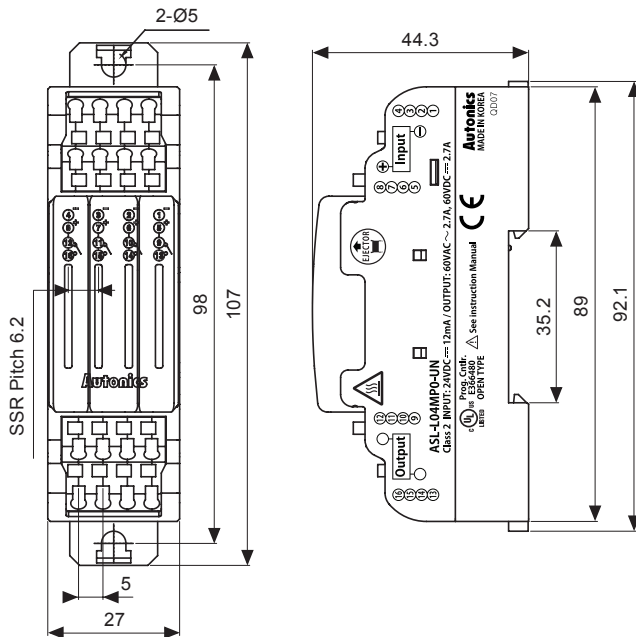

Jumper bar (model: JB-6.0-04L)

※For the desired application (NPN/PNP/Load common), the jumper bar is sold separately.

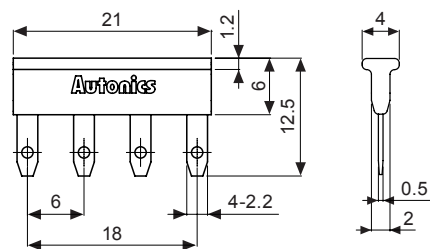

High Temperature Caution

Make sure do not touch the heat sink or the unit body while power is supplied or right after load power is turned off. If not, it may cause a burn.

Wire Connections

※ NPN, PNP, LOAD common are operated by the inserting position of the Jumper bar.
Please refer to '● Using jumper bars' of '■ Replacing SSR and Using Jumper Bar'.

ASL-L01MP0-□□/ASL-L04MP0-□□

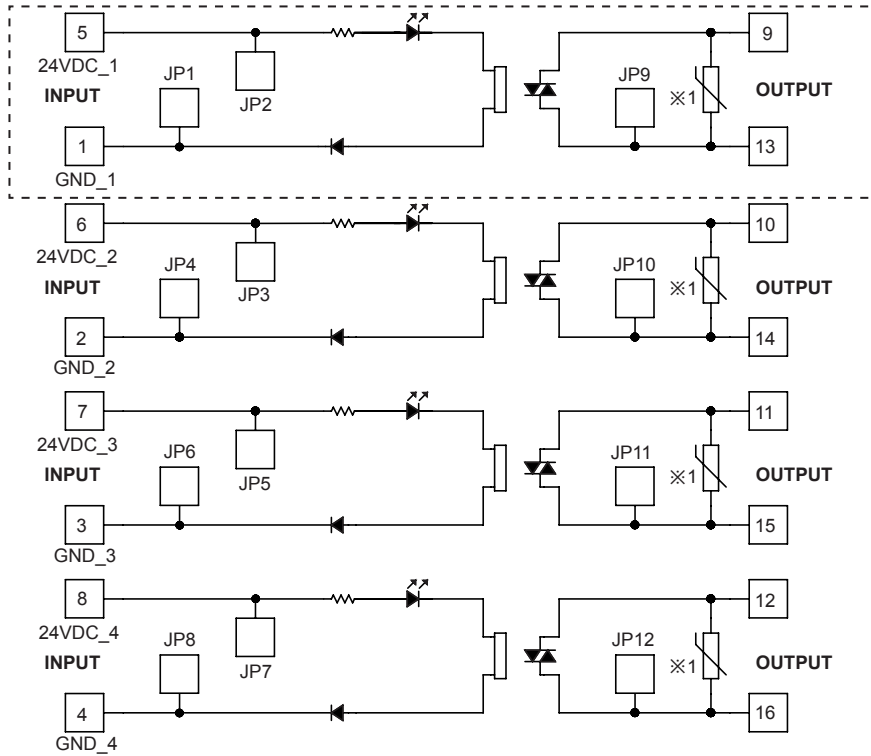

※□□ parts are only for 1-point model.
※1: Only for ASL-L01(04)□□-UY(varistor installed type).

ASL-L01SP0(SP1/SR0/ST0)-□□/ASL-L04SP0(SP1/SR0/ST0)-□□

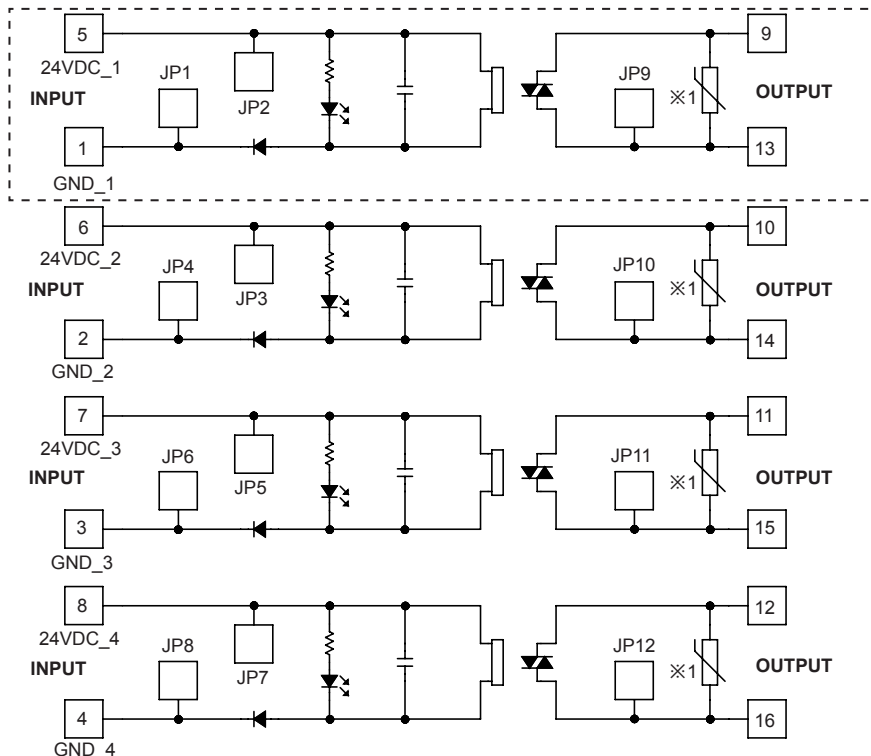

※□□ parts are only for 1-point model.
※There is no condenser for ASL-L□ SR0-□□ model.
※1: Only for ASL-L01(04)□□-UY (varistor installed type).

I/O Terminal Blocks

Interface Terminal Block

AFS (screw)
AFL (screwless)
AFR (rising clamp)

Common Terminal Block

ACS (screw)

Sensor Connector Terminal Block

AFE (sensor Connector)

Relay Terminal Block

ABS (screw)

ABL (screwless)

ASL (screwless)

Power Relay (relay terminal block)

SSR (relay terminal block)

I/O Cables

mitsubishi

LSIS

Autonics

RS Automation

YOKOGAWA

FUJII

KDT

OMRON

TELEMECANIQUE

For SERVO

Open Type Cables

Cable Appearance

Remote I/O

ARD (DeviceNet Digital Standard Terminal Type)

ARD (DeviceNet Digital Sensor Connector Type)

ARD (DeviceNet Analog Standard Terminal Type)

ARM (Modbus Digital Sensor Connector Type)

Others

Sensor Connectors

Sockets

Sensor Distribution Boxes

Valve Plugs

Thumbwheel Switches

■ Connecting Crimp Terminals

○ Connecting and removing end sleeve (ferrule terminal) crimp terminal at screwless type terminal block

● Connecting

1) Push the end sleeve (ferrule terminal) crimp terminal towards direction ① to complete the connection.

● Removing

1) Press and hold the catch above the terminal in direction ② with a flathead screwdriver.
2) Pull and remove the end sleeve (ferrule terminal) crimp terminal towards direction ③.

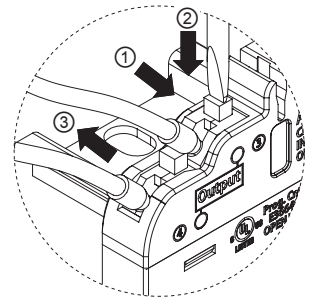

■ Replacing SSR and Using Jumper Bar

○ ASL-L01□-□□

※ASL-L01□-□□ model is integrated SSR type. The unit cannot replace only SSR.

● Using jumper bar

The right figure example is for 4 ASL-L01□-□□ units with jumper bar.
For power common, insert a jumper bar to top (belows 1, 2 terminals).
For load common, insert a jumper bar to bottom (above 3, 4 terminals).

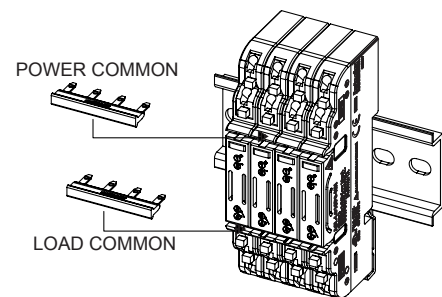

○ ASL-L04□-□□

● Replacing SSR

1) Pull the protection cover towards direction ①.
2) Insert the ejector as proper side to ② direction and pull it to ③ direction to remove.
3) Insert a new SSR to the case.

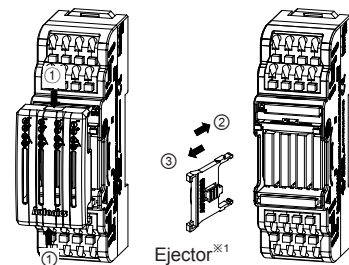

※1: Two way ejector position for SSR replacement
(there is no ejector for SSR SN-24A01C model)

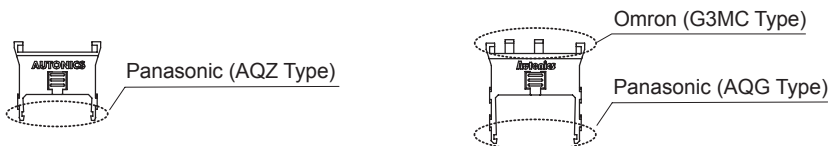

● Using jumper bars

Remove the protection cover and use the jumper bars accordingly.

NPN COMMON	PNP COMMON	LOAD COMMON
Insert the jumper bar to the far left towards terminals 4 and 8.	Insert the jumper bar to the far right towards terminals 1 and 5.	Insert the jumper bar above terminals 12, 11, 10, 9.

Installation

※When installing the unit, keep the interval between the units.
(refer to the 'Example Of Installation'.)

1. Mounting and removal at DIN rail

● Mounting

- 1) Pull the rail lock towards direction ①.
 - 2) Attach the DIN rail connection part onto the DIN rail.
 - 3) Push the unit towards direction ②, then push the rail lock in to lock toward the unit.
- ※In case of ASL-L01□-□□, hook the DIN rail connection part to DIN rail and push the unit towards direction ②.

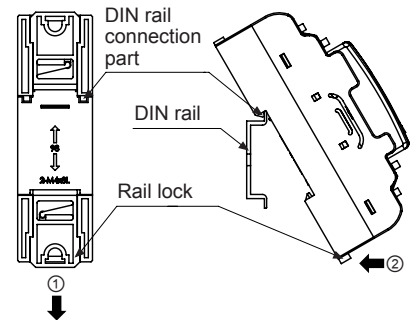

● Removal (ASL-L01□-□□)

- 1) Pull-up the bottom edge of the unit on rail lock to ① direction like a lever.

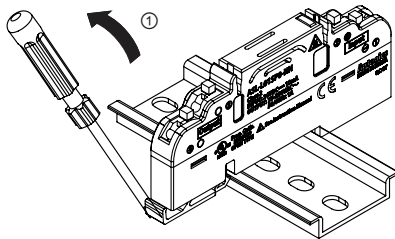

● Removal (ASL-L04□-□□)

- 1) Insert a screwdriver into the rail lock hole and push it towards direction ①.
- 2) Remove the unit by pulling the unit towards direction ②.

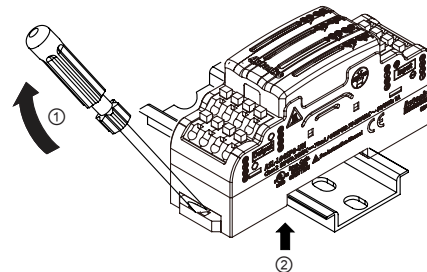

2. Mounting with screws (only for ASL-L04□-□□)

- 1) The unit can be mounted on panels using the rear rail locks.
- 2) Pull the rail locks towards up/down directions.
- 3) M4×10mm spring washer screws are recommended for installation.
When using flat washers, use Ø9mm diameter washers. The tightening torque should be between 1.0 to 1.5N·m.

Example of Installation

● ASL-L01□-□□

1 unit individual installation
(pitch between each SSR: over 18mm)

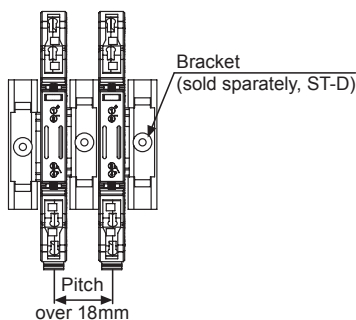

● ASL-L01□-□□

4 units arranging installation
(pitch between each SSR: 9mm)

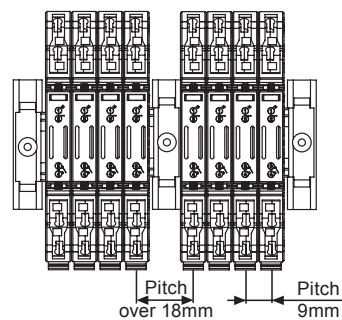

● ASL-L04□-□□

individual installation
(pitch between each SSR: 6.2mm)

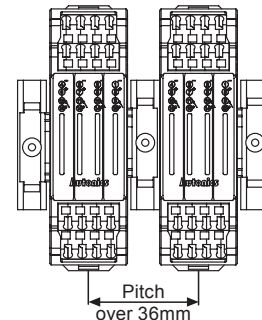

※Pitch is interval between SSRs.

I/O Terminal Blocks

Interface Terminal Block

AFS (screw)
AFL (screwless)
AFR (rising clamp)

Common Terminal Block

ACS (screw)

Sensor Connector Terminal Block

AFE (sensor Connector)

Relay Terminal Block

ABS (screw)

ABL (screwless)

ASL (screwless)

Power Relay (relay terminal block)

SSR (relay terminal block)

I/O Cables

MITSUBISHI

LSIS

Autonics

RS Automation

YOKOGAWA

FUJI

KDT

OMRON

TELEMECANIQUE

For SERVO

Open Type Cables

Cable Appearance

Remote I/O

ARD (DeviceNet Digital Standard Terminal Type)

ARD (DeviceNet Digital Sensor Connector Type)

ARD (DeviceNet Analog Standard Terminal Type)

ARM (Modbus Digital Sensor Connector Type)

Others

Sensor Connectors

Sockets

Sensor Distribution Boxes

Valve Plugs

Thumbwheel Switches

Temperature Derating Curve

- Load current by ambient temperature for each rated current

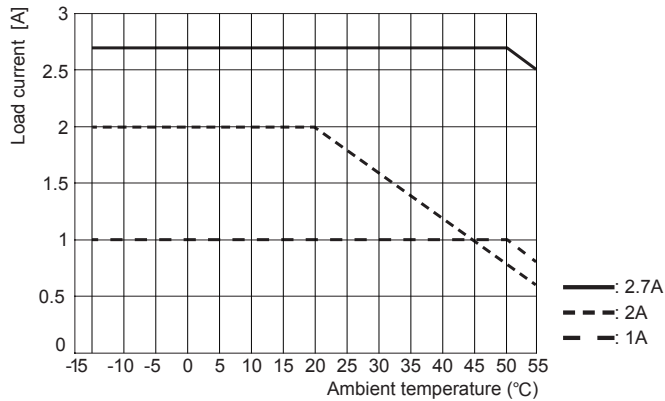

- When installing ASL-L04 individually, load current by ambient temperature for SSRs interval

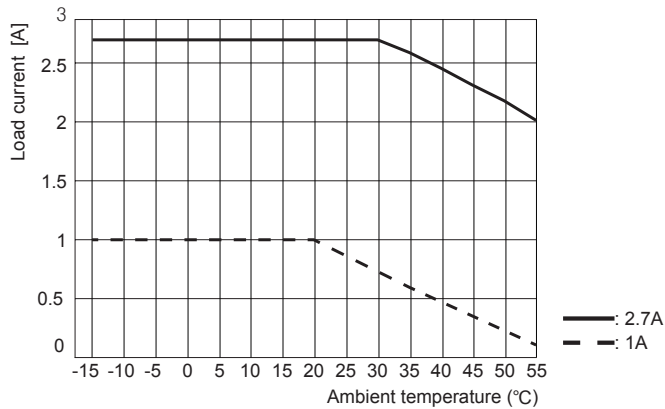

- When installing ASL-L01, load current by ambient temperature for SSRs interval

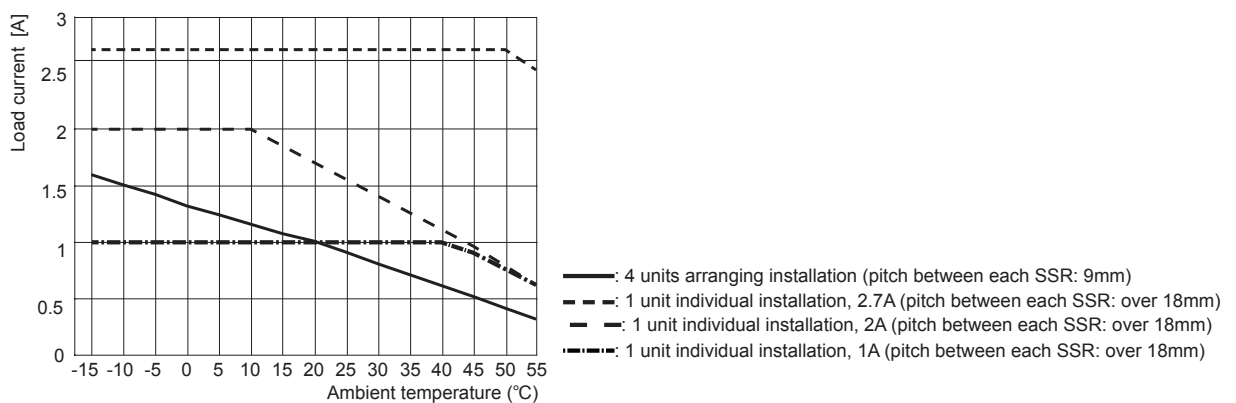

■ Cautions during Use

1. Use the unit within the rated environment of specification.
2. Supply power within the rated allowable voltage range.
3. Check the polarity of power or COMMON before connecting PLC or other controllers.
4. When connecting the power input, use AWG22-16 (0.30 to 1.25mm²). For using crimp terminals, refer to '■ Crimp Terminal Specifications'.
5. Do not connect wire, remove connector, or replace SSR while connected to a power source.
6. Do not touch the unit immediately after the load power is supplied or cut. It may cause burn by high temperature.
7. Power supply should be insulated and limited voltage/current or Class 2 SELV power supply device.
8. Do not use the unit at below places.
 - ① Environments with high vibration or shock.
 - ② Environments where strong alkali or acids are used.
 - ③ Environments with exposure to direct sunlight.
 - ④ Near machinery which produce strong magnetic force or electric noise
9. This unit may be used in the following environments.
 - ① Indoors
 - ② Altitude max. 2,000m
 - ③ Pollution degree 2
 - ④ Installation category II

I/O Terminal Blocks

Interface Terminal Block

- AFS (screw)
- AFL (screwless)
- AFR (rising clamp)

Common Terminal Block

- ACS (screw)

Sensor Connector Terminal Block

- AFE (sensor Connector)

Relay Terminal Block

- ABS (screw)
- ABL (screwless)
- ASL (screwless)
- Power Relay (relay terminal block)
- SSR (relay terminal block)

I/O Cables

- mitsubishi
- LSIS
- Autonics
- RS Automation
- YOKOGAWA
- FUJI
- KDT
- OMRON
- TELEMECANIQUE
- For SERVO
- Open Type Cables
- Cable Appearance

Remote I/O

- ARD (DeviceNet Digital Standard Terminal Type)
- ARD (DeviceNet Digital Sensor Connector Type)
- ARD (DeviceNet Analog Standard Terminal Type)
- ARM (Modbus Digital Sensor Connector Type)

Others

- Sensor Connectors
- Sockets
- Sensor Distribution Boxes
- Valve Plugs
- Thumbwheel Switches