

AiSA-D Series

AC Type 2-Phase Closed-Loop Stepper Motor Driver

■ Features

- Brake operation for safe control of vertical load at power OFF and alarm occur. (Built-in brake type)
- Higher cost-efficiency compared to servo motor drivers
- Torque control mode supported
- Able to check alarms and status with Alarm/Status display part (7 segment)
- Rapid response which is advantageous for the short distance continuous operation
- Able to implement Low frequency operation and high torque in low speed area
- Low current drive at middle-high speed area
- Max. stop torque at current down mode (available vertical load attaching)
- Easy to set various Gain with rotary switch
- Applicable to the precision equipment such as optical inspection equipment with the features of maintaining torque in stop and having no micro vibration (hunting)
- Various resolutions
: 500, 1000, 1600, 2000, 3200, 3600, 5000, 6400, 7200, 10000 (10 steps)
- 10-levels of resolution setting
- Frame size 60mm, 86mm (Applied Motor: AiA-M Series)



 Please read "Safety Considerations" in the instruction manual before using.



■ Applications

- Filed requiring preciseness such as semiconductor equipment, 3D printer, optical inspection equipment, chip mounter, cartesian robot, conveying equipment, and alignment stage.

■ Ordering Information

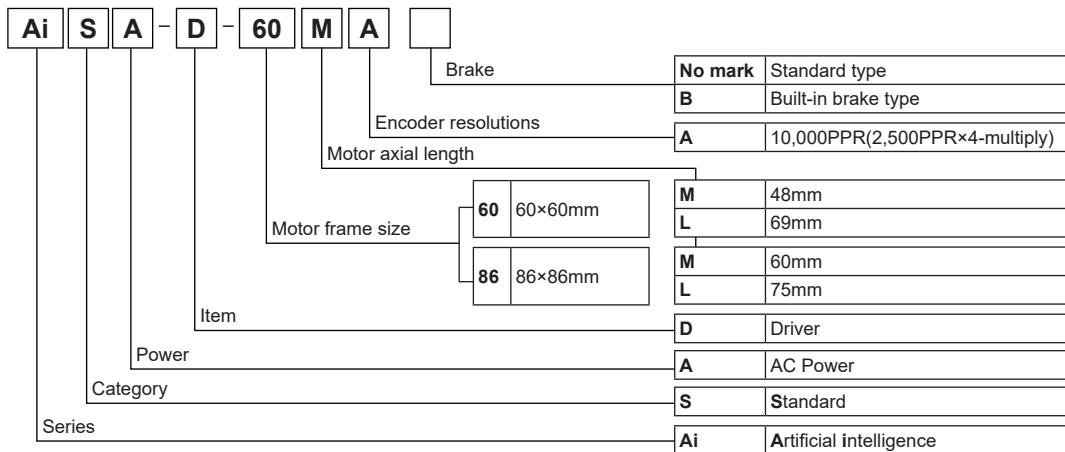

AC Type 2-Phase Closed-Loop Stepper Motor Driver

■ Configuration Diagram

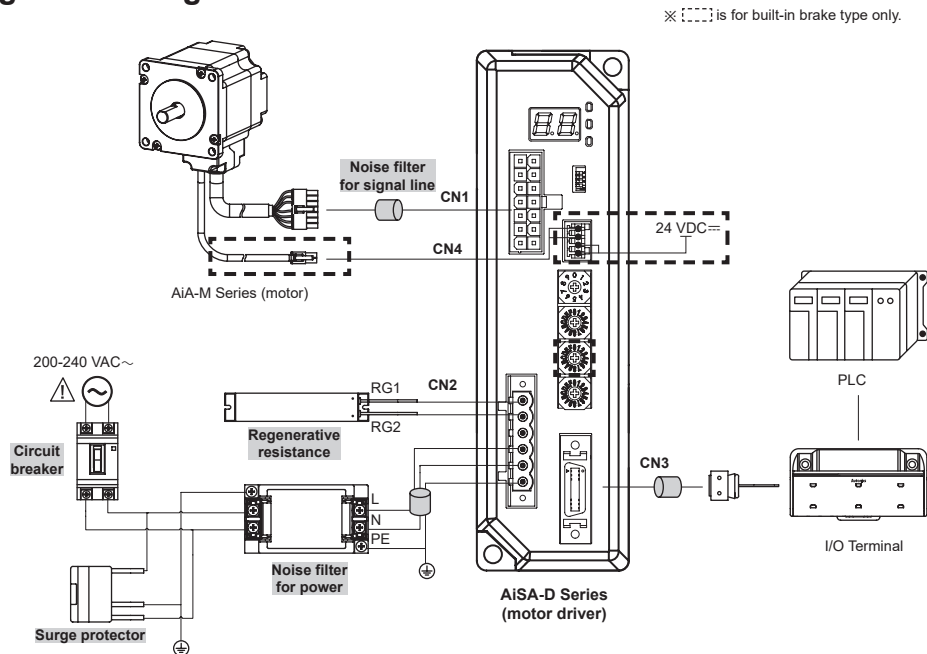

※ The thickness of cable should be same or thicker than the below specifications when connecting the cable for connector.

- ① CN1(motor+encoder connector): AWG22
- ② CN2(power connector): AWG18
- ③ CN3(I/O connector): AWG28
- ④ CN4(brake connector): AWG22

※ In case of unwanted noise generating from peripherals and power, use ferrite core in the wiring.

※ [] is sold separately.

○ Noise filter for signal line

-Connect to wiring to suppress external noise.

-Depending on frequency, filtered noise may different.

Model	Specification	Manufacture
Motor line, I/O signal line	28A5776-0A2	Lairdtech
Power line	28A5131-0A2	

○ Regenerative resistance

-Connect Pin no. 1, 2 on power connector (CN2).

-Use in condition of the high inertia load or the short deceleration time.

-Forced cooling is required in condition of high surface temperature of regenerative resistance.

Model	Specification	Manufacture
IRC100	<ul style="list-style-type: none"> ● Resistance: 100Ω ±5%, ● Rated Power: 60W(standby), 100W(heatsink attached) 	Rara Electronics Corp.

○ Noise filter for power

-Connect the power to suppress external noise.

-The wires should be connected as short as possible and grounded.

Model	Specification	Manufacture
RNS-2006	<ul style="list-style-type: none"> ● Rated voltage: 250V ● Rated current: 6A ● Max. leakage current: 1mA 	Orient Electronics

○ Surge protector

Protect the product from external noise and surge by connecting power.

※ Be sure to disconnect the surge protector when testing internal pressure.

It may result in product damage.

Model	Specification	Manufacture
LT-C12G801W	<ul style="list-style-type: none"> ● Nomial discharge current: 2500A ● Max. discharge current: 5000A ● Voltage protection level: 1.5kV 	OTOWA Electric Co. Ltd

SENSORS

FIELD INSTRUMENTS

CONTROLLERS

MOTION DEVICES

SOFTWARE

(A) Closed Loop Stepper System

(B) Stepper Motors

(C) Stepper Motor Drivers

(D) Motion Controllers

AiSA-D Series

■ Specifications

Model ^{※1}		AiSA-D-60MA(-B)	AiSA-D-60LA(-B)	AiSA-D-86MA(-B)	AiSA-D-86LA(-B)
Power consumption	Power supply	200-240 VAC~ 50/60 Hz			
	STOP ^{※2}	Max. 60 W		Max. 65 W	Max. 70 W
	Max. during operation	Max. 160 W	Max. 220 W	Max. 250 W	Max. 300 W
	Max. Run current ^{※3}	2.0 A/Phase			
Auxiliary power ^{※4}	Power supply	24 VDC==			
	Input current	0.3 A		0.5 A	
STOP current	Standard type	20% or 30% of max. RUN current (factory default: 30%)			
	Built-in brake type	20 to 100% of max. RUN current			
Rotation speed		0 to 3000 rpm			
Resolution ^{※5}		500 (factory default), 1000, 1600, 2000, 3200, 3600, 5000, 6400, 7200, 10000 PPR			
Speed filter ^{※5}		0 (disable) (factory default), 2, 4, 6, 8, 10, 20, 40, 60, 80, 100, 120, 140, 160, 180, 200 ms			
Motor GAIN ^{※5}	Standard type	Within the range of motor gain: 1 to 32			
	Built-in brake type	Standard GAIN: 0 to F, Inertia GAIN: 0 to F			
In-Position ^{※5}		Fast Response: 0 (factory default) to 7, Accurate Response: 0 to 7			
Pulse input method ^{※5}		1-pulse or 2-pulse input (factory default) method			
Motor rotation direction ^{※5}		CW (factory default), CCW			
Status indicator		<ul style="list-style-type: none"> ● Alarm/Status display part: orange LED 7 seg. (built-in brake type: red LED 8 seg.) ● Power/Alarm indicator: green/red LED ● In-Position indicator: orange LED ● Servo On/Off indicator: blue LED 			
I/O	Input	CW, CCW (Run pulse) Servo On/Off (photocoupler input) - [H]: 24 VDC==, [L]: 0-0.5 VDC==, Pulse width - min. 1 ms Alarm reset (photocoupler input) - [H]: 24 VDC==, [L]: 0-0.5 VDC==, Pulse width - min. 10 ms			
	Output	<ul style="list-style-type: none"> ● Photocoupler: In-Position, Alarm out ● Line driver: encoder signal (phase A, \bar{A}, B, \bar{B}, Z, \bar{Z}) 			
Operation mode ^{※4}		Standard, Torque mode			
Input pulse specifications	Pulse width	CW, CCW: input pulse frequency duty 50 %			
	Rising/Falling time	CW, CCW: max. 0.5 μ s			
	Pulse input voltage	CW, CCW - [H]: 4-8 VDC==, [L]: 0-0.5 VDC==			
	Max. input pulse freq. ^{※6}	CW, CCW: 500 kHz			
Alarm		Overcurrent, overspeed, position tracking, overload, overheat, motor connection, encoder connection, overvoltage, undervoltage, motor misalignment, command pulse, in-position, brake ^{※4}			
Input resistance	Standard type	220 Ω (CW, CCW), 10k Ω (Servo On/Off, alarm reset)			
	Built-in brake type	4.7 k Ω (Anode Pull-up)			
Insulation resistance	Standard type	Over 100M Ω (at 500VDC== megger)			
	Built-in brake type	Over 200 M Ω (at 500 VDC== megger)			
Dielectric strength		1,500 VAC~ 60 Hz for 1 min			
Vibration		1.5 mm amplitude at frequency of 10 to 55 Hz (for 1 min) in each X, Y, Z direction for 2 hours			
Shock		300 m/s ² (approx. 30 G) in each X, Y, Z direction for 3 times			
Environment	Ambient temp.	0 to 50 °C, storage: -10 to 60 °C			
	Ambient humi.	35 to 85 %RH, storage: 10 to 90 %RH			
Protection structure		IP20 (IEC standard)			
Approval		CE 			
Weight ^{※7}	Standard type	Approx. 920 g (approx. 800 g)			
	Built-in brake type	Approx. 1,020 g (approx. 780 g)			

※1: The model name indicates driver type. (none: standard type, B: built-in brake type)

E.g.) AiSA-D-60MA-B: built-in brake type stepping motor driver.

※2: Based on the ambient temperature 25 °C, ambient humidity 55 %RH, and STOP current 20 %.

※3: RUN current varies depending on the input RUN frequency and max. RUN current at the moment varies also.

※4: Corresponding specification is only available in built-in brake type and is not available in standard type.

※5: Settings are available with the switches located on the front. When setting, the power must not be applied and cannot be set after power is applied.

※6: Max. input pulse frequency is max. frequency to be input and is not the same as max. pull-out frequency or max. slewing frequency.

※7: The weight includes packaging. The weight in parentheses is for unit only.

※ Environment resistance is rated at no freezing or condensation.

AC Type 2-Phase Closed-Loop Stepper Motor Driver

■ Dimensions

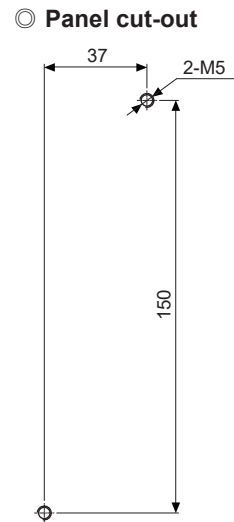
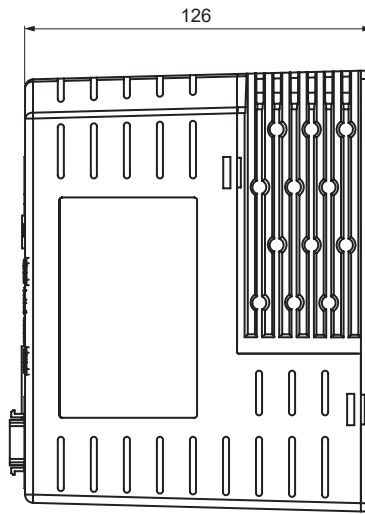
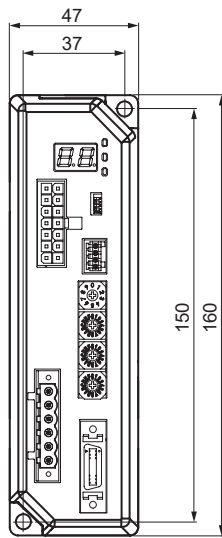

■ Installation

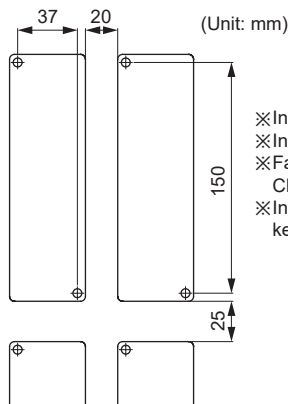

- ※ Install on the metal plate with high thermal conductivity for heat dissipation of the driver.
 - ※ Install in the well-ventilated area and install the cooling fan in the unventilated environment.
 - ※ Failure to heat dissipation may result in damage or malfunction due to the stress on the product.
- Check the environment of use within the rated specifications and install on the well-heat dissipated area.
- ※ In case of installing the drivers more than two, keep distance at least 20mm in the horizontal direction and at least 25mm in the vertical direction.

■ Unit Descriptions

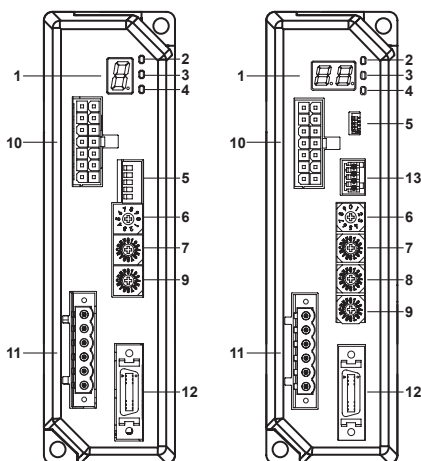

1. Alarm/Status display part (orange)
2. Power/Alarm indicator (PWR/ALM) (green/red)
3. In-Position indicator (INP) (orange)
4. Servo On/Off indicator (SERVO) (blue)
5. Function selection DIP switch
6. Resolution rotary switch (RES)
7. Motor gain setting rotary switch (GAIN)
8. Speed filter / Limit setting rotary switch (S.F)^{※1}
9. In-Position setting rotary switch (INP)
10. Motor+Encoder connector (CN1)
11. Power connector (CN2)
12. I/O connector (CN3)
13. Brake connector (CN4)^{※1}

※1: Corresponding connector and switch are for built-in brake type only.

SENSORS
FIELD INSTRUMENTS
CONTROLLERS
MOTION DEVICES
SOFTWARE
(A) Closed Loop Stepper System
(B) Stepper Motors
(C) Stepper Motor Drivers
(D) Motion Controllers

AiSA-D Series

■ Driver Status Indicators

Indicator & Display part	LED color	Function	Descriptions
PWR/ALM	Green	Power indicator	Turns ON when the unit operates normally after supplying power
	Red	Alarm indicator	When alarm occurs, it flashes in various ways depending on the situation. Refer to '■ Control Input/Output → ○ Output → 2. Alarm'.
INP	Orange	In-Position indicator	Turns ON when motor is placed at command position after positioning input.
SERVO	Blue	Servo On/Off indicator	Turns ON when Servo is operating, turns OFF when servo is not operating.
Alarm/Status display part	Red (built-in brake type: orange)	Alarm, status indicator	When alarm occurs, it displays number of the corresponding alarm and the setting number of the rotary switches (RES/GAIN/INP)

■ Driver Setting

○ Function selection DIP switch

-Set rotation direction, stop current, pulse input method, motor gain, torque mode and etc.

[Standard type]

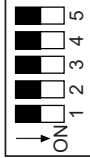
	No.	Name	Function	Switch position	
				ON	OFF (factory default)
	1	DIR	Rotation direction	CCW	CW
	2	1P/2P	Pulse input method	1-pulse input method	2-pulse input method
	3	CD	STOP current	20% of max. RUN current	30% of max. RUN current
	4	GM	Gain setting	High gain	Low gain
	5 ^{※1}	RVD	Test mode	Test mode	Normal mode

※1: Set to OFF when using the device. It is only for the operation test in manufacturing process.

[Built-in brake type]

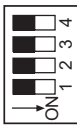
	No.	Name	Function	Switch position	
				ON	OFF (factory default)
	1	DIR	Rotation direction	CCW	CW
	2	1P/2P	Pulse input method	1-Pulse input method	2-Pulse input method
	3	GS H/L	Motor GAIN setting	Inertia GAIN	Standard GAIN
	4	TM	Torque mode	Torque mode	Standard mode

● Pulse input method

※ 1-pulse input method

CW: rotation operation signal input

CCW: rotation direction signal input

([H]: forward rotation, [L]: reverse rotation)

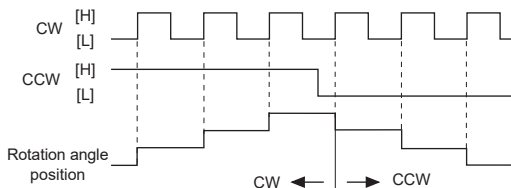

※ 2-pulse input method

CW: forward rotation signal input

CCW: reverse rotation signal input

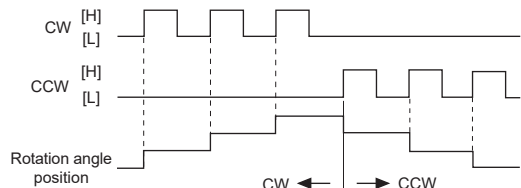

※ [H]: photocoupler ON (voltage of both ends 4-8VDC), [L]: photocoupler OFF (voltage of both ends 0-0.5VDC)

● STOP current

-In order to decrease motor heat and current consumption at motor stopping moment (in case there is no input during the time of the double width of last input pulse), set the stop current supplied to the motor phase.

AC Type 2-Phase Closed-Loop Stepper Motor Driver

RES: Resolution setting switch

-Set the resolution of driver.

-The number of pulses per 1 rotation by resolution is each 500, 1000, 1600, 2000, 3200, 3600, 5000, 6400, 7200, 10000.

-Modified setting values are not applied in the running status, and the values will be applied after motor stopped.

Setting	Pulse/Revolution	Resolution	Setting	Pulse/Revolution	Resolution
0(factory default)	500	2.5	5	3600	18
1	1000	5	6	5000	25
2	1600	8	7	6400	32
3	2000	10	8	7200	36
4	3200	16	9	10000	50

GAIN: Motor gain setting switch

-Depending on GM OFF or GS H/L switch setting, the motor sets GAIN.

-Motor GAIN is selectable from 32 GAIN.

-The larger gain is, the more improved transient response becomes and the less error occurs.

※ At the lowest system load status, raise the gain value until motor vibrates and set to 1 to 2 level lower.

Standard type	GM OFF - Low GAIN				GM ON - High GAIN			
Built-in brake type	GS H/L OFF - Standard GAIN				GS H/L ON - Inertia GAIN			
Setting	GAIN	Setting	GAIN	Setting	GAIN	Setting	GAIN	
0	×1	8	×9	0	×17	8	×25	
1	×2	9	×10	1	×18	9	×26	
2	×3	A	×11	2	×19	A	×27	
3	×4	B	×12	3	×20	B	×28	
4	×5	C	×13	4	×21	C	×29	
5	×6	D	×14	5	×22	D	×30	
6	×7	E	×15	6	×23	E	×31	
7	×8	F	×16	7	×24	F	×32	

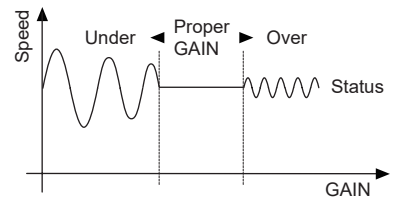

S.F: Speed Filter / Limit setting switch

-Corresponding switch is only available in built-in brake type.

-Depending on TM switch setting, speed filter and speed limit function can be set.

Speed Filter

-In standard mode, it sets the delay time between the command position and the motor position.

-It determines the responsiveness of the motor to the command and smoothly follows the speed even if the load changes or disturbance occurs.

Speed Limit

-In torque mode, it sets the speed limit.

-When the rotation speed reaches the speed limit value, the torque control may become unstable. Set value greater than the speed to be limited.

Setting	Speed Filter (TM OFF)		Speed Limit (TM ON)				
	Delay time	Setting	Limit speed	Setting			
0	Disable	8	60 ms	0	10 rpm	8	90 rpm
1	2 ms	9	80 ms	1	20 rpm	9	120 rpm
2	4 ms	A	100 ms	2	30 rpm	A	150 rpm
3	6 ms	B	120 ms	3	40 rpm	B	200 rpm
4	8 ms	C	140 ms	4	50 rpm	C	250 rpm
5	10 ms	D	160 ms	5	60 rpm	D	300 rpm
6	20 ms	E	180 ms	6	70 rpm	E	380 rpm
7	40 ms	F	200 ms	7	80 rpm	F	500 rpm

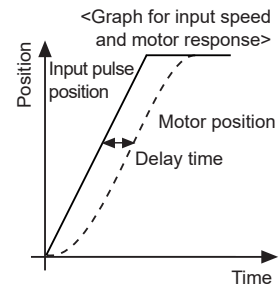

INP: In-Position setting switch

-After position command pulse has finished, if the gap between target position and real position is under In-Position setting value, positioning completion pulse is output.

-Modified setting values are not applied in the running status, and the values will be applied after motor stopped.

Setting	Fast response		Accurate response	
	Value	Setting	Value	Setting
0(factory default)	0	8	0	0
1	±1	9	±1	±1
2	±2	A	±2	±2
3	±3	B	±3	±3
4	±4	C	±4	±4
5	±5	D	±5	±5
6	±6	E	±6	±6
7	±7	F	±7	±7

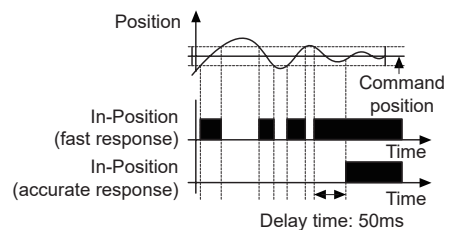

SENSORS
FIELD INSTRUMENTS
CONTROLLERS
MOTION DEVICES
SOFTWARE
(A) Closed Loop Stepper System
(B) Stepper Motors
(C) Stepper Motor Drivers
(D) Motion Controllers

AiSA-D Series

Driver Connectors

Connector function

● CN1: Motor+Encoder Connector

Pin no.	Function	Pin no.	Function
1	GND	8	+5VDC
2	Encoder A	9	Encoder \bar{A}
3	Encoder B	10	Encoder \bar{B}
4	Encoder Z	11	Encoder \bar{Z}
5	PE	12	N-C
6	Motor A	13	Motor B
7	Motor \bar{A}	14	Motor \bar{B}

● CN2: Power connector

Pin no.	Function
1	Regenerative resistance
2	Regenerative resistance
3	N-C
4	N-C
5	Power
6	PE

● CN3: I/O connector

Pin no.	I/O	Function	Pin no.	I/O	Function
1	Input	CW+	11	Output	In-Position+
2	Input	CW-	12	Output	In-Position-
3	Input	CCW+	13	—	N-C
4	Input	CCW-	14	—	N-C
5	Input	Servo On/Off+	15	Output	Encoder A
6	Input	Servo On/Off-	16	Output	Encoder \bar{A}
7	Output	Alarm Out+	17	Output	Encoder B
8	Output	Alarm Out-	18	Output	Encoder \bar{B}
9	Input	Alarm Reset+	19	Output	Encoder Z
10	Input	Alarm Reset-	20	Output	Encoder \bar{Z}

● CN4: Brake connector

Pin no.	Function
1	24 VDC
2	GND
3	Brake+
4	Brake-

※Corresponding connector is for built-in brake type only.

Connector specifications

Type	Specifications	Connector terminal	Housing	Manufacture
CN1	Motor+Encoder	5557-14R	5556T	Molex
CN2	Power	5ESDVM-06P-OR	—	Dinkle
CN3	I/O connector	10120-3000PE	—	10320-52F0-008 3M
CN4	Brake connector	ESC250V-S2330704P	—	Dinkle

※Above connectors are suitable for AiSA-D Series.

Sold Separately

※It is recommended to use ferrite core at I/O cable and Motor+Encoder cable.

I/O cable

● CO20-MP□-R (standard: AiS TAG)

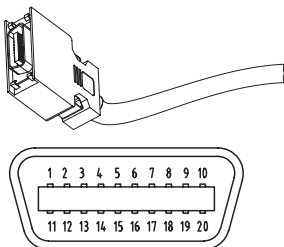

Pin no.	Function (name tag)	Cable color	Dot line color-numbers	Pin no.	Function (name tag)	Cable color	Dot line color-numbers
1	CW+	Yellow	Black-1	11	In-Position+	White	Black-1
2	CW-		Red-1	12	In-Position-		Red-1
3	CCW+		Black-2	13	—		Black-2
4	CCW-		Red-2	14	—		Red-2
5	Servo On/Off+		Black-3	15	Encoder A+		Black-3
6	Servo On/Off-	Red-3	16	Encoder A-	Red-3		
7	Alarm Out+	Black-4	17	Encoder B+	Black-4		
8	Alarm Out-	Red-4	18	Encoder B-	Red-4		
9	Alarm Reset+	Black-5	19	Encoder Z+	Black-5		
10	Alarm Reset-	Red-5	20	Encoder Z-	Red-5		

※□ of model name indicates cable length (010, 020).

For corresponding EMC standard, cable length should be below 2m.

E.g.) CO20-MP020-R: 2m I/O cable.

Motor+Encoder cable

● Normal: C1D14M-□, Moving: C1DF14M-□

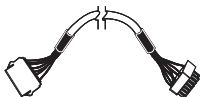

※□ of model name indicates cable length (1, 2, 3, 5, 7, 10)

E.g.) C1DF14M-10: 10m moving type motor+encoder cable.

AC Type 2-Phase Closed-Loop Stepper Motor Driver

■ Control Input/Output

Inner signal of all input/output consists of photocoupler.

ON, [H]: photocoupler power ON

OFF, [L]: photocoupler power OFF

○ Input

1. Position command pulse

-Pulse input is selectable from 1-pulse input method and 2-pulse input method.

(Refer to 'SW1: Function selection DIP switch'.)

-When using extending cable, it is recommended to connect Common mode choke coil (2mH) to the CW, CCW terminal in series connection.

2. Servo On/Off

-This signal is for rotating axis of motor using external force or used for manual positioning.

-Servo On/Off signal maintains over 1ms as [H]

: Regarded as Servo Off signal and phase current is cut to release torque.

The Servo ON indicator, the In-Position output and indicator turns OFF.

-Servo On/Off signal maintains over 1ms as [L]

: Regarded as Servo On signal and phase current is supplied to gain torque.

The Servo ON indicator, the In-Position output and indicator turns ON.

※Stop the motor for using the signal.

※Refer to '4. Example of input circuit connection'.

3. Alarm Reset

-This signal is for clearing the alarm.

-Alarm reset signal maintains over 20ms as [H]

: Alarm is cleared, the alarm indicator and alarm output turns OFF, and the driver returns to normal status.

※If the causes of the alarm are not removed, driver may not be returned to the normal status even with alarm reset.

※Refer to '4. Example of input circuit connection'.

4. Example of input circuit connection

[Standard type]

● Input pulse (CW, CCW)

-It is recommended to use 5VDC at V_{CC} and short the R_L .

-In case V_{CC} is over 5VDC, calculate R_L value using following formula and use V_{CC} below 30VDC.

-In case V_{CC} is 12, 24VDC, refer to the table as follow.

$$\times R_L = \frac{V_{CC} - 2.17V}{0.011A} - 220\Omega$$

V_{CC}	R_L
12VDC	680 Ω (min. 0.25W)
24VDC	1.8k Ω (min. 0.5W)

A. Pull-Up

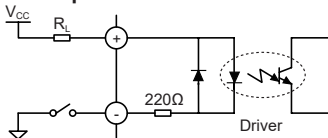

B. Pull-Down

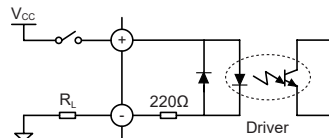

C. Circuit with NPN (not-reversed)

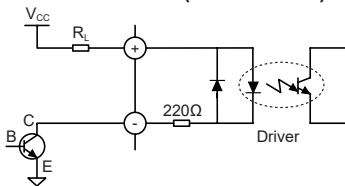

D. Circuit with PNP (reversed)

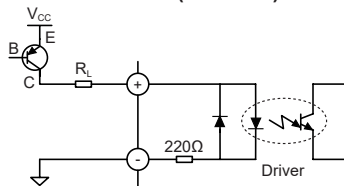

● External input (Servo On/Off, Alarm Reset)

A. Pull-Up

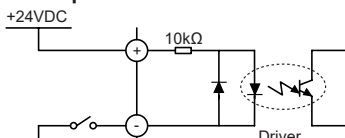

B. Pull-Down

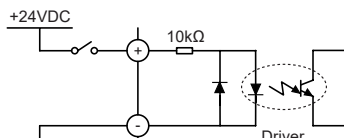

C. Circuit with NPN (not-reversed)

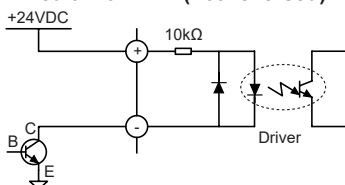

D. Circuit with PNP (reversed)

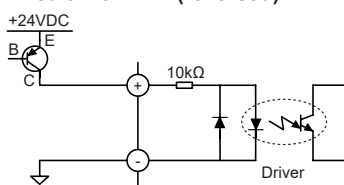

SENSORS
FIELD INSTRUMENTS
CONTROLLERS
MOTION DEVICES
SOFTWARE
(A) Closed Loop Stepper System
(B) Stepper Motors
(C) Stepper Motor Drivers
(D) Motion Controllers

AiSA-D Series

[Built-in brake type]

● Input pulse (CW, CCW)

- Use external power (VEX) 5 VDC in pulse input.
- When input power is exceeded, it may result the product damage.
- In case the external pulse input power (VEX) is over 5VDC, use external resistor R_L .
- In case the external pulse input power (VEX) is over 12, 24VDC, refer to the R_L as table below.

$$\times R_L = \frac{V_{EX} - 2.17V}{0.011A} - 220\Omega$$

V_{CC}	R_L
12VDC	680Ω (Min. 0.25W)
24VDC	1.7kΩ (Min. 0.5W)

A. Differential line driver

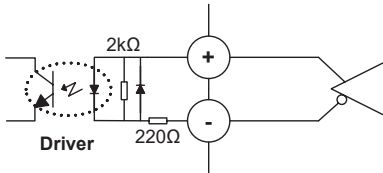

B. Open collector

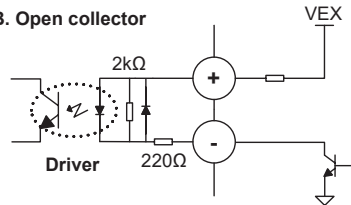

● External Input (Servo On/Off, Alarm Reset)

- Use external power (VEX) 24 VDC in external input Servo On/Off and Alarm Reset.

A. PNP circuit

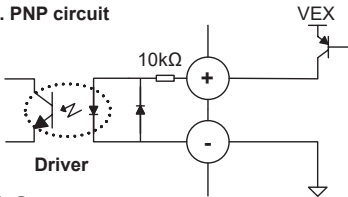

B. NPN circuit

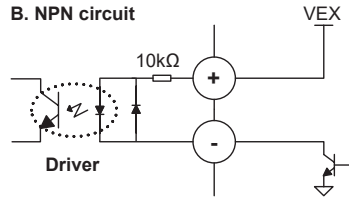

◎ Output

1. In-Position

- In-Position output is output condition of positioning completion signal.
- If the gap between target position and real position is under In-Position setting value after position command pulse has finished, In-Position output turns to [H] and the In-Position indicator turns ON.
- In reverse, when the gap is over In-Position setting value, In-Position output turns to [L] and the In-Position indicator turns OFF.
- For accurate drive, check the In-Position output again and execute the next drive.

× Refer to '3. Example of output circuit connection'.

2. Alarm

● Alarm

- This function stops motor to protect driver, depending on the error status such as overcurrent or overspeed.
- In case of normal status, output is [H], and in case of alarming status, output is [L].
- When supplying alarm reset, driver returns to the normal status.

× Refer to '3. Example of output circuit connection'.

● Alarm/Status display

- When alarm occurs, the alarm indicator (ALM, red) flashes as the times of corresponding alarm type.
- The alarm/status display part displays the number of the corresponding alarm type.

No. of flashing	Alarm/Status	Alarm type	Descriptions	Motor stop	Maintain torque
1	E1	Overcurrent error	When overcurrent flows at motor RUN element	O	X
2	E2	Overspeed error	When motor speed is over 3,500rpm		
3	E3	Position tracking error	When the gap between position command value and current position value is over 90°		
4	E4	Overload error	When applying load over the rated load for over 1 sec		
5	E5	Overheat error	When heatsink temperature is over 90°C		
6	E6	Motor connection error	When motor cable connection error occurs at driver		
7	E7	Encoder connection error	When encoder cable connection error occurs at driver		
8	E8	Overvoltage error	When input voltage is over 240VAC +10%		
9	E9	Undervoltage error ^{×1}	When input voltage is under 200VAC -10%		
10	EA	Motor misalignment	When motor is in misalignment		
11	Eb	Command pulse error	When input pulse is over 3,500rpm When pulse is input before initial alignment		
12	EC	In-Position error	When position error (over 1) is kept over 3 sec, after motor stopped.		
13	Ed	Brake error ^{×2}	When brake failed to operate.		

×1: When cutting off the power, the undervoltage error occurring is normal operation.

×2: Corresponding alarm is only available in built-in brake type.

× Depending on the alarm type, it flashes for 0.4 sec interval and it turns OFF for 0.8 sec repeatedly.

<E.g. case of alarm 3>

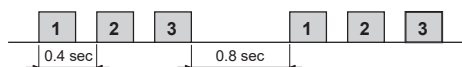

AC Type 2-Phase Closed-Loop Stepper Motor Driver

3. Example of output circuit connection

[Standard type]

-It is recommended to use below 50VDC at V_{CC} . Use the R_L for I_C (collector current of secondary detector) of photocoupler inside the driver to be within 25mA following the below formula.

$$\text{※A: } R_L = \frac{V_{CC} - 0.3V - V_F}{0.025A} - 10\Omega \quad \text{※B, C: } R_L = \frac{V_{CC} - 0.3V}{0.025A} - 10\Omega$$

(V_F is LED forward voltage of primary photocoupler.)

A. Circuit with photocoupler

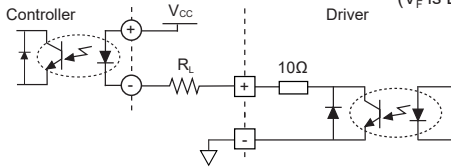

B. Circuit with pull up (reversed)

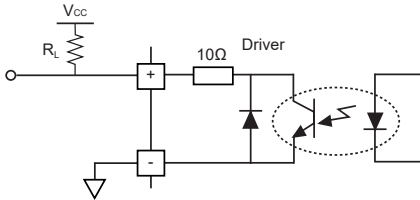

C. Circuit with pull down (not-reversed)

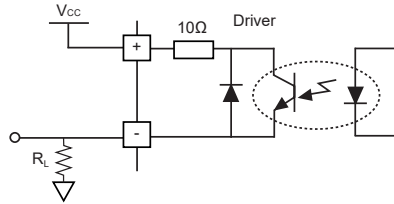

[Built-in brake type]

• External output signal circuit

-Use external power (VCC) max. 30 VDC, 10mA for output.
-When current is over 10mA, use external resistor R_L to control current.

Open collector

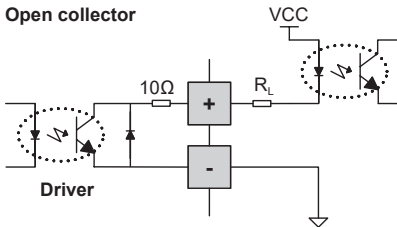

$$\text{※}R_L = \frac{V_{CC} - 0.7V - V_F}{0.01A} - 10\Omega$$

V_F : LED forward voltage of primary photocoupler

• Encoder output signal circuit

-Encoder output signal uses a line driver (26C32).
-Connect the terminal resistance R_L of 100 to 150Ω in parallel to both ends (A, \bar{A} , B, \bar{B} , Z, \bar{Z}) of each phase of encoder.

Differential line driver

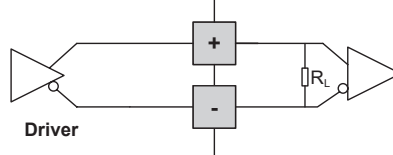

4. Encoder output waveforms

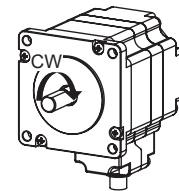
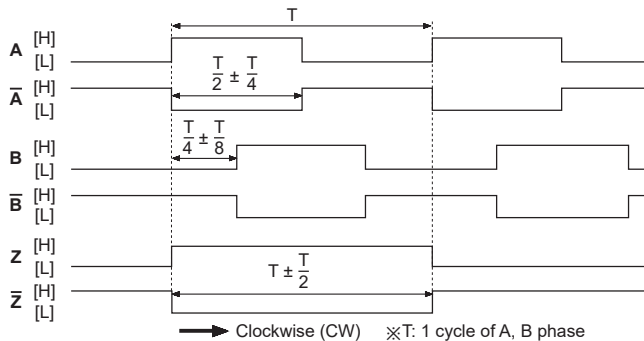

※It is recommended to use Line driver output (corresponding to 26C32) at RECEIVER end of encoder output and terminating resistors (100-150Ω) in parallel to both ends of each phase (A, \bar{A} , B, \bar{B} , Z, \bar{Z} , corresponding to 26C31).

SENSORS
FIELD INSTRUMENTS
CONTROLLERS
MOTION DEVICES
SOFTWARE
(A) Closed Loop Stepper System
(B) Stepper Motors
(C) Stepper Motor Drivers
(D) Motion Controllers

AiSA-D Series

■ Connection for Motor and Driver

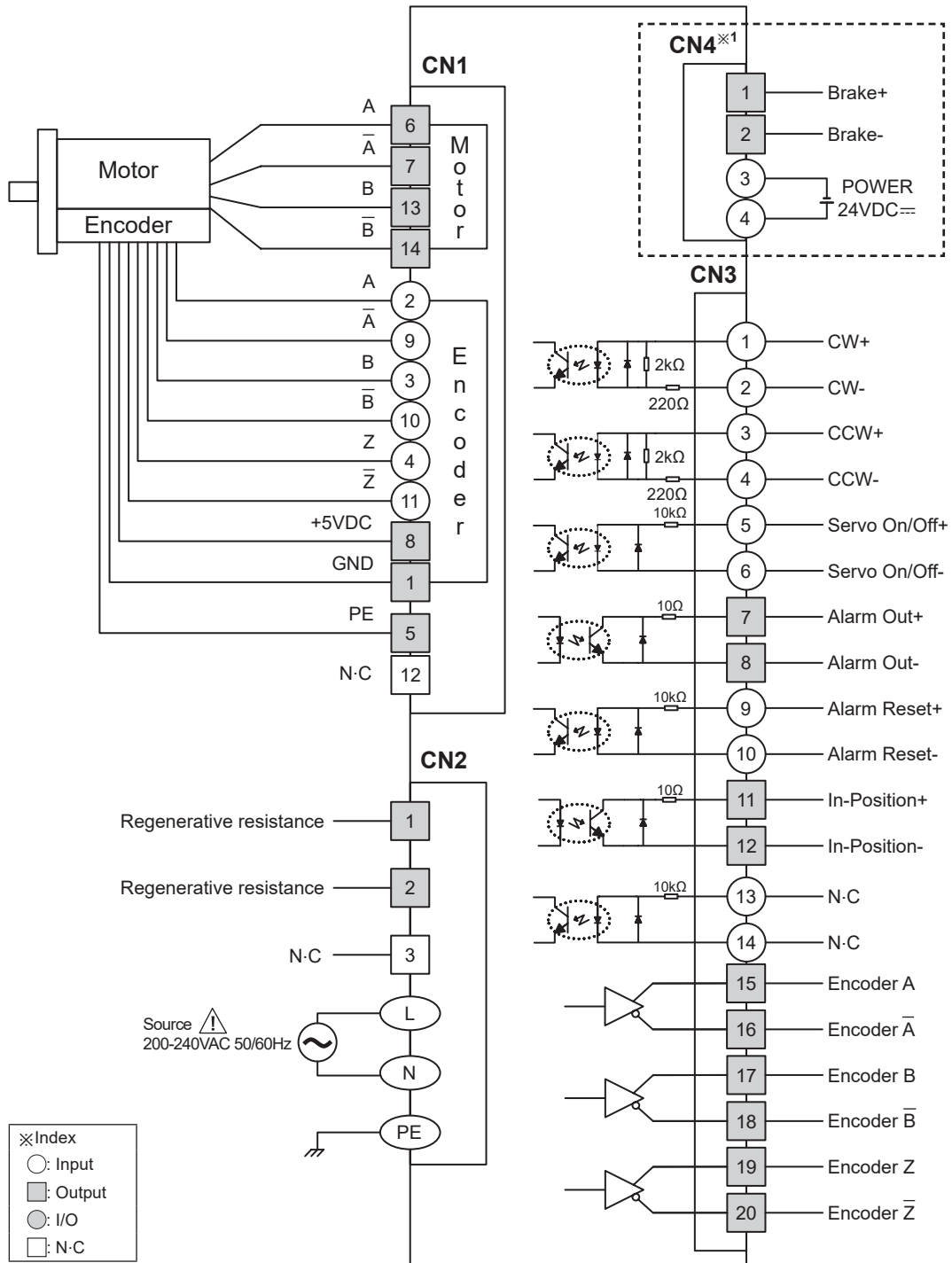

※1: Corresponding connector is for built-in brake type only.

AC Type 2-Phase Closed-Loop Stepper Motor Driver

■ Troubleshooting

Malfunction	Causes	Troubleshooting
When motor does not excite	Servo is not ON.	Check that servo On/Off input signal is [L]. In case of [H], servo is off and excitation of motor is released.
	Alarm occurs.	Check the alarm type and remove the cause of alarm.
When motor rotates to the opposite direction of the designated direction	Rotation direction setting is not correct.	Check the DIR setting in the function selection DIP switch.
When motor drive is unstable	Connection between motor and encoder is unstable.	Check the Motor+Encoder connection cable.
	Motor gain value is not correct.	Check motor GAIN setting rotary switch (GAIN) value.

■ Proper Usage

- Follow instructions in 'Proper Usage'. Otherwise, it may cause unexpected accidents.
- Do not input CW, CCW signal at the same time in 2-pulse input method.
- When the signal input voltage is exceeded the rated voltage, connect additional resistance at the outside.
- To extend the motor+encoder cable, use the designated cable.
- Keep the distance between power cable and signal cable more than 10cm.
- Install the unit vertically on the alarm/status display part upper side.
- For heat radiation of the driver, install a fan.
- Do not change any setting switches (function, resolution, motor gain, in-position switches) during the operation or after supplying power.
Failure to follow this instruction may result in malfunction.
- Do not input external signal until the driver is initialized (In-Position LED ON) after power is applied.
- Motor vibration and noise can occur in specific frequency period.
 - ① Change motor installation method or attach the damper.
 - ② Use and set the gain value.
- For using motor, it is recommended to maintenance and inspection regularly.
 - ① Unwinding bolts and connection parts for the unit installation and load connection
 - ② Strange sound from ball bearing of the unit
 - ③ Damage and stress of lead cable of the unit
 - ④ Connection error with motor
 - ⑤ Inconsistency between the axis of motor output and the center, concentric (eccentric, declination) of the load, etc.
- This product does not prepare protection function for a motor.
- This unit may be used in the following environments.
 - ① Indoors (in the environment condition rated in 'Specifications')
 - ② Altitude max. 2,000m
 - ③ Pollution degree 2
 - ④ Installation category II

SENSORS

FIELD INSTRUMENTS

CONTROLLERS

MOTION DEVICES

SOFTWARE

(A)
Closed Loop Stepper System

(B)
Stepper Motors

(C)
Stepper Motor Drivers

(D)
Motion Controllers