

## DIN W48×H48mm 8 Pin Plug Timer

### ■ Features

- Wide range of the time selection (0.01 sec to 9999.9 hour)
- Selectable voltage input (PNP) method or no-voltage input (NPN) method
- Dot for Decimal Point / Hour. Min. Sec. by RESET key
- Wide range of power supply : 100-240VAC 50/60Hz, 24VAC 50/60Hz, 24-48VDC universal
- Memory protection for 10 years (using non-volatile semiconductor)
- Built-in Microprocessor



**⚠ Please read "Safety Considerations" in the instruction manual before using.**



### ■ Ordering Information

**FS 4 E - 1P 4**

Power supply	2	24VAC 50/60Hz, 24-48VDC
	4	100-240VAC 50/60Hz
Output	1P	1-stage setting
	I	Indicator
Timer	E	Timer
Display digit	4	9999 (4-digit)
	5	99999 (5-digit)
Item	FS	8-pin plug timer

※8-pin socket (PG-08, PS-08(N)) is sold separately.

### ■ Specifications

Model	1-stage setting	FS4E-1P2	FS4E-1P4	—
	Indicator	—	—	FS5E-I4
Display digit		4-digit		5-digit
Character size (W×H)		3.8×7.6mm		4×8mm
Power supply		24VAC~ 50/60Hz, 24-48VDC≡	100-240VAC~ 50/60Hz	
Permissible voltage range		90 to 110% of rated voltage		
Power consumption		Max. 3.5VA (24VAC~ 50/60Hz), Max. 2.3W (24-48VDC≡)	Max. 4.6VA (100-240VAC~ 50/60Hz)	Max. 3.8VA (100-240VAC~ 50/60Hz)
Return time		Max. 500ms		
Time operation		Power ON Start		
Min. signal width		RESET, INHIBIT: approx. 20ms		
Input method		Selectable voltage input (PNP) method or no-voltage input (NPN) method [Voltage input (PNP) method] input impedance: max. 10.8kΩ, [H]: 5-30VDC≡, [L]: 0-2VDC [No-voltage input (NPN) method] short-circuit impedance: max. 470Ω, short-circuit residual voltage: max. 1VDC, open-circuit impedance: min. 100kΩ		
One-shot output time		0.05 to 5 sec		
Control output	Contact	Type		Time-limit SPDT (1c)
	Capacity			250VAC~ 3A, 30VDC≡ 3A resistive load
Relay	Mechanical	Min. 5,000,000 operations		
life cycle	Electrical	Min. 100,000 operations (250VAC 3A resistive load)		
Memory retention		Approx. 10 years (non-volatile memory)		
Repeat error				
Set error				
Voltage error		Max. ±0.01% ±0.05 sec		
Temp. error				
Insulation resistance		Over 100MΩ (at 500VDC megger)		
Dielectric strength		2,000VAC 50/60Hz for 1 min (between all terminals and case)		
Noise immunity	AC voltage	±2kV the square wave noise (pulse width 1μs) by noise simulator		
	AC/DC voltage	±500V the square wave noise (pulse width 1μs) by noise simulator		
Vibration	Mechanical	0.75mm amplitude at frequency 10 to 55Hz (for 1 min) in each X, Y, Z direction for 1 hour		
	Malfunction	0.5mm amplitude at frequency 10 to 55Hz (for 1 min) in each X, Y, Z direction for 10 min		
Shock	Mechanical	300m/s <sup>2</sup> (approx. 30G) in each X, Y, Z direction for 3 times		
	Malfunction	100m/s <sup>2</sup> (approx. 10G) in each X, Y, Z direction for 3 times		
Environment	Ambient temp.	-10 to 55°C, storage: -25 to 65°C		
	Ambient humi.	35 to 85%RH, storage: 35 to 85%RH		
Protection structure		IP20 (front part, IEC standard)		
Approval		CE c UL US		
Weight <sup>※1</sup>		Approx. 130g (approx. 90g)		Approx. 120g (approx. 80g)

※1: The weight includes packaging. The weight in parenthesis is for unit only.

※Environment resistance is rated at no freezing or condensation.

SENSORS

CONTROLLERS

MOTION DEVICES

SOFTWARE

(J) Temperature Controllers

(K) SSRs

(L) Power Controllers

(M) Counters

(N) Timers

(O) Digital Panel Meters

(P) Indicators

(Q) Converters

(R) Digital Display Units

(S) Sensor Controllers

(T) Switching Mode Power Supplies

(U) Recorders

(V) HMIs

(W) Panel PC

(X) Field Network Devices

## ■ Connections

### ● FS4E-1P4

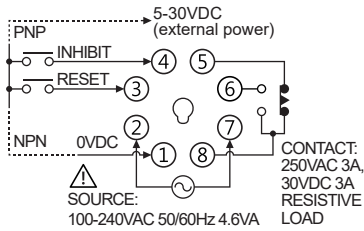

### ● FS4E-1P2

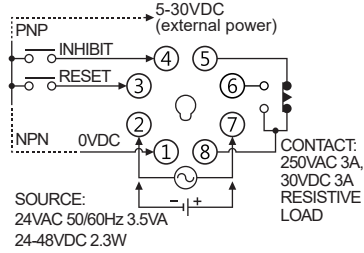

### ● FS5E-I4

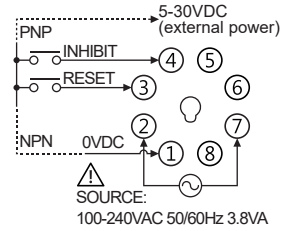

## ■ Input Connections

### ○ Voltage input (PNP)

#### ● Solid-state input (standard sensor: PNP output type sensor)

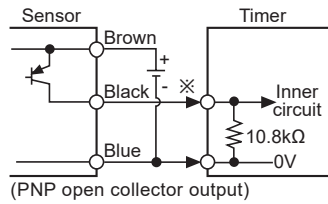
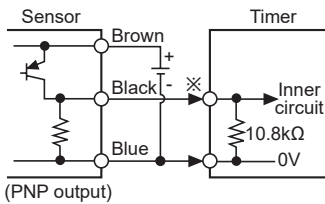

#### ● Contact input

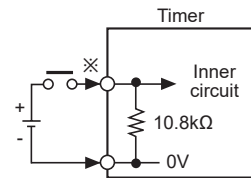

※INHIBIT, RESET input part

### ○ No-voltage input (NPN)

#### ● Solid-state input (standard sensor: NPN output type sensor)

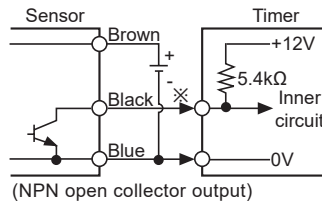
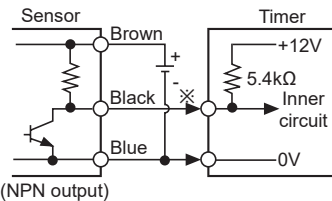

#### ● Contact input

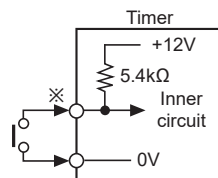

※INHIBIT, RESET input part

# 8 Pin Plug Timer

## ■ Dimensions

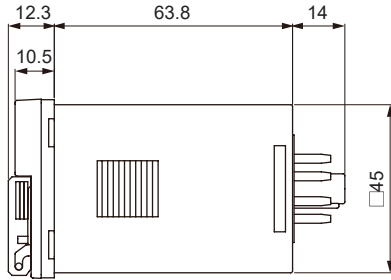
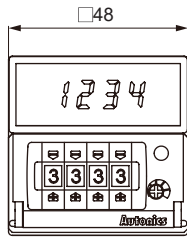

(unit: mm)

## ○ Bracket

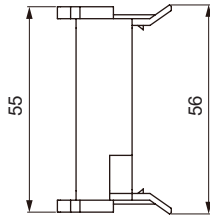
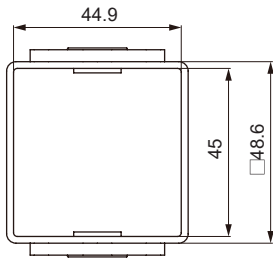
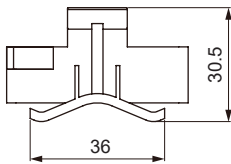

## ○ Panel cut-out

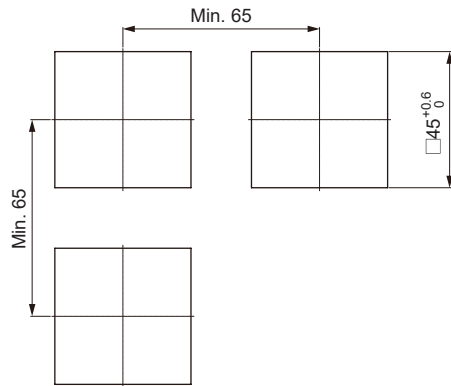

## ■ DIP Switch Setting

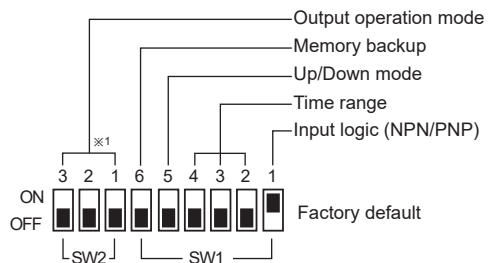
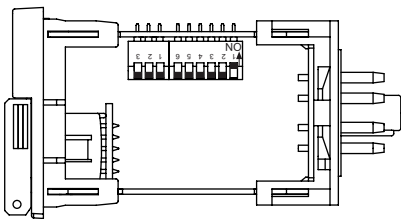

### ● Input logic (INHIBIT, RESET input)

SW1	Function
1	ON <input type="checkbox"/> NPN (no-voltage input)
	OFF <input type="checkbox"/> PNP (voltage input)

### ● Up/Down mode

SW1	Function
5	ON <input type="checkbox"/> Down mode
	OFF <input type="checkbox"/> Up mode

### ● Memory backup

SW1	Function
6	ON <input type="checkbox"/> No memory backup
	OFF <input type="checkbox"/> Memory backup

※How to change settings

Power OFF → change settings → power ON → press **[RESET]** key or input signal (min. 20ms)

SENSORS
CONTROLLERS
MOTION DEVICES
SOFTWARE

(J) Temperature Controllers
(K) SSRs
(L) Power Controllers
(M) Counters
(N) Timers

(O) Digital Panel Meters
(P) Indicators
(Q) Converters
(R) Digital Display Units

(S) Sensor Controllers
(T) Switching Mode Power Supplies

(U) Recorders
(V) HMIs

(W) Panel PC
(X) Field Network Devices

# FSE Series

## Time Range

SW1	4-digit	5-digit
	99.99 sec	9999.9 sec
	999.9 sec	99999 sec
	9999 sec	9 min 59.99 sec
	99 min 59 sec	99 min 59.9 sec

SW1	4-digit	5-digit
	999.9 min	9999.9 min
	99 hour 59 min	9 hour 59 min 59 sec
	999.9 hour	999 hour 59 min
	9999 hour	9999.9 hour

## Dot for Hour, Min, Second

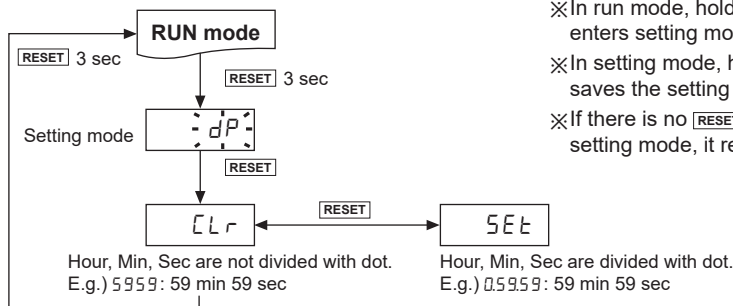

- ※ In run mode, hold the **RESET** key for over 3 sec, and it enters setting mode[dP].
- ※ In setting mode, hold the **RESET** key for over 3 sec, and it saves the setting and returns to RUN mode.
- ※ If there is no **RESET** key input for 60 sec when entering setting mode, it returns to RUN mode.

## Time Operation for Indicator (FS5E-I4)

### Up mode

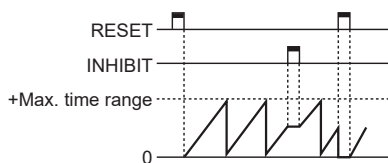

### Down mode

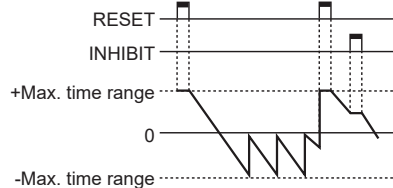

※ - display is only for F, K, Q, S output operation mode and it cannot be set.

## Error Display and Output Operation

Error Display	Error description	Troubleshooting
Err0	Setting value is 0.	Change the setting value anything but 0.

- ※ When error occurs, the output turns OFF.
- ※ Indicator model does not have error display function.

## Output Operation Mode

	← One-shot output (0.05 to 5 sec)	← Self-holding output	
Output mode (SW2)	ON <b>Up mode</b> OFF	ON <b>Down mode</b> OFF	Operation
<b>F</b>			After time-up, the display value increases or decreases until reset signal input is applied and self-holding output is maintained.
<b>N</b>			After time-up, the display value and self-holding output are maintained until reset signal input is applied.
<b>C</b>			When time-up, the display value is reset and it operates simultaneously.
<b>R</b>			After time-up, the display value is reset after one-shot output time and it operates simultaneously.
<b>K</b>			After time-up, the display value increases or decreases until reset signal input is applied.
<b>P</b>			After time-up, the display value is maintained while output is ON. The value is internally reset and it operates simultaneously.
<b>Q</b>			After time-up, the display value increases or decreases during one-shot output time.
<b>S</b>			Output turns OFF→ON→OFF operates repeatedly (flicker).

※Set one-shot output time by front TIME volume switch.

SENSORS
CONTROLLERS
MOTION DEVICES
SOFTWARE
(J) Temperature Controllers
(K) SSRs
(L) Power Controllers
(M) Counters
(N) Timers
(O) Digital Panel Meters
(P) Indicators
(Q) Converters
(R) Digital Display Units
(S) Sensor Controllers
(T) Switching Mode Power Supplies
(U) Recorders
(V) HMIs
(W) Panel PC
(X) Field Network Devices

## ■ Proper Usage

- Follow instructions in 'Proper Usage'. Otherwise, it may cause unexpected accidents.
- 24-48VDC, 24VAC power supply should be insulated and limited voltage/current or Class 2, SELV power supply device.
- Use the product, 0.1 sec after supplying power.
- When supplying or turning off the power, use a switch or etc. to avoid chattering.
- Install a power switch or circuit breaker in the easily accessible place for supplying or disconnecting the power.
- Keep away from high voltage lines or power lines to prevent inductive noise.  
In case installing power line and input signal line closely, use line filter or varistor at power line and shielded wire at input signal line.  
Do not use near the equipment which generates strong magnetic force or high frequency noise.
- Change setting time(T1), time range or etc. after turning off the power of the timer.
- This product may be used in the following environments.
  - ① Indoors (in the environment condition rated in 'Specifications')
  - ② Altitude max. 2,000m
  - ③ Pollution degree 2
  - ④ Installation category II