

Technical Description

Overview and Principle

Electronic counter

A counter which mainly consists of transistors, ICs, micro-computers, etc.

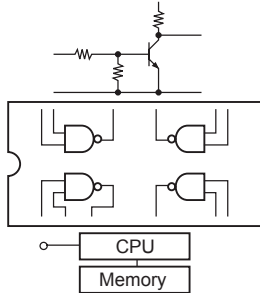

Preset counter

A counter whose control output operates when it counts up to a setting value.

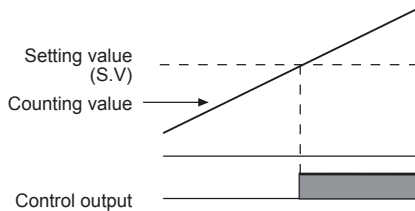

Indicator counter

A counter which indicates the total value of the counting inputs is not provided with a control output.

Input mode

Up mode

A mode that counting value is ascending from "zero" when one pulse signal comes in.

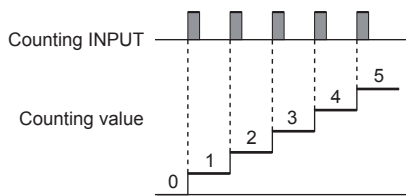

Down mode

A mode that counting value is descending from SV when one pulse signal comes in. For indicator type, counting value is descending from + max. display value.

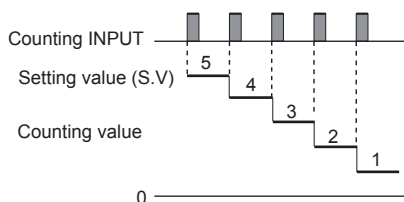

Input operation mode

There are several input operation modes; Command input mode (Up/Down-A,D), Individual input mode (Up/Down-B,E), Phase difference input mode (Up/Down-C), Count up input mode (Up), Count down input mode (Down). Counting value is either ascended or descended depends on input signal condition (cp1, cp2). Following explanations focus on using voltage input (PNP) state.

Up mode

Count up input mode (Up)

Counting up as the number of cp1 signals, but it does not count while cp2 signal is being applied.

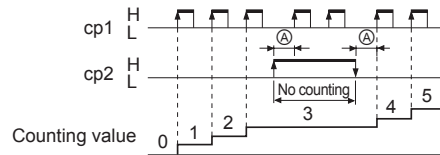

When it is on Count up input mode, counting is still available even if sensor's output type is not matched with counter's input type. (e.g. Voltage input type of counter connected with NPN output type sensor.)

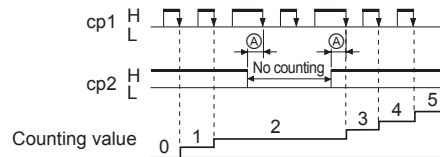

※A: Over min. signal width, B: Over 1/2 of min. signal width. If the signal width of A or B is less than min. signal width, it may cause ± 1 count error.

Down mode

Count down input mode (Down)

Counting down as the number of cp1 signals, but it does not count while cp2 signal is being applied.

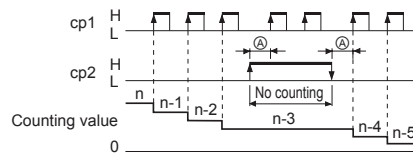

When it is on Count up input mode, counting is still available even if sensor's output type is not matched with counter's input type. (e.g. Voltage input type of counter connected with NPN output type sensor.)

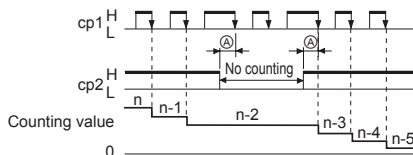

※A: Over min. signal width, B: Over 1/2 of min. signal width. If the signal width of A or B is less than min. signal width, it may cause ± 1 count error.

● Up/Down mode

① Command input mode (Up/Down-A)

Counting up as the number of cp1 signals, and counting down as the number of cp1 signals while cp2 signals are being applied.

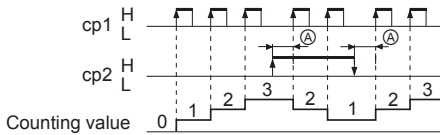

② Individual input mode (Up/Down-B)

Counting up as the number of cp1 signals, and counting down as the number of cp2 signals. However, if cp1 and cp2 signals are applied at a same time, it will not be counted.

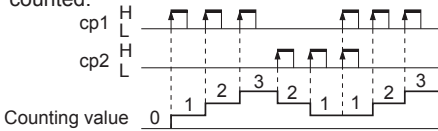

③ Phase difference input mode (Up/Down-C)

It is a mode that measures each phases of cp1 and cp2. It counts up when cp1 signal phase applied later than cp2 signal, and counts down when cp1 signal phase is applied earlier. There have to be phase difference between those two phases.

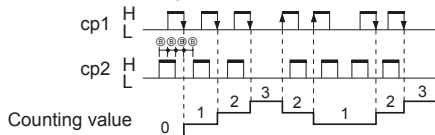

④ Command input mode (Up/Down-D)

Counting down as the number of cp1 signals, and counting up as the number of cp1 signals while cp2 signals are being applied.

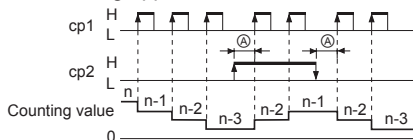

⑤ Individual input mode (Up/Down-E)

Counting down as the number of cp1 signals, and counting up as the number of cp2 signals. However, if cp1 and cp2 signals are applied at the same time, it will not be counted.

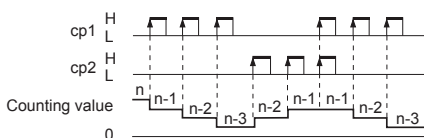

⑥ Phase difference input mode (Up/Down-F)

It is a mode that measures each phases of cp1 and cp2. It counts down when cp1 signal phase applied later than cp1's, and counts up when cp1 signal phase is applied earlier. There have to be phase difference between those two phases.

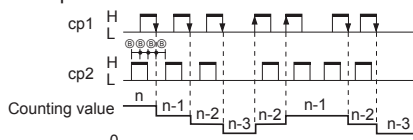

◎ About Counting

● Pulse

An wave that has repetitive and temporal changes of its level.

● Count

Counting the number of pulses.

● Miss count

A state that number of pulses and counted is not matched.

● CPS (Count Per Second)

Unit of counts per second that express counting speed.

● Duty ratio

The ratio of the ON signal time of a given input signal to the OFF signal time of the same input signal. (The maximum counting speed of each counter is determined by a counting input signal with an ON/OFF ratio of 1:1.)

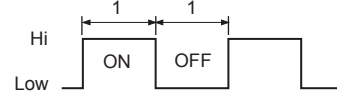

● Maximum counting speed

The maximum counting speed at which the output section of the counter operates accurately without miscounting when input signal with ON/OFF ratio is 1:1. [The maximum counting speed is expressed in units of counts per second (CPS)].

● Zero blanking

A function that removes unnecessary "zero" on display so that users do not have to be confused when reading display. E.g.) When "123" is being displayed

* Display with zero blanking function applied:

* Display without zero blanking function:

◎ Memory protection

A function that restores data counted until right before the main power is cut off and shows it on the display when having power source back.

◎ Reset

To restore the counting, display and output sections of the counter, to their initial states.

● Manual reset

To mechanically reset the counter by manual means.

● Power reset

To reset the counter by cutting off the operating supply voltage.

● External reset

To reset the counter by applying a specific signal to the reset input signal terminal.

(A) Photoelectric Sensors

(B) Fiber Optic Sensors

(C) Door/Area Sensors

(D) Proximity Sensors

(E) Pressure Sensors

(F) Rotary Encoders

(G) Connectors/ Connector Cables/ Sensor Distribution Boxes/Sockets

(H) Temperature Controllers

(I) SSRs / Power Controllers

(J) Counters

(K) Timers

(L) Panel Meters

(M) Tacho / Speed / Pulse Meters

(N) Display Units

(O) Sensor Controllers

(P) Switching Mode Power Supplies

(Q) Stepper Motors & Drivers & Controllers

(R) Graphic/ Logic Panels

(S) Field Network Devices

(T) Software

Technical Description

- **Automatic reset**

To reset the counter automatically with a signal generated from inside the counter.

- **Reset signal width**

Min. reset signal width to reset by power off or by applying external (manual) reset signal.

◎ **Input**

If the signal width of either ON or OFF is narrower than regular, it may not be counted as a signal.
E.g.) Maximum counting speed is 2kcps.

$$\text{Cycle} = \frac{1}{2\text{kHz}} = 0.5\text{ms}$$

Thus, signal width of ON and OFF should be at least over 0.25ms.

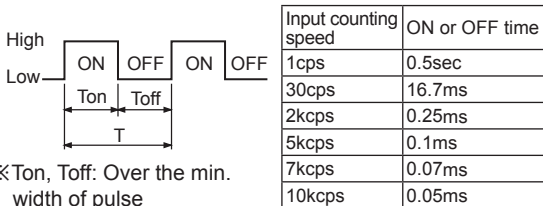

- **Non-voltage input**

A way that counter receiving input signal from input terminal (cp1, cp2) when whose electric potential phase is turning "High" to "Low".

- **Voltage input**

Electric potential is applied through input terminal (cp1, cp2), and counter receives input signal when electric potential phase is turning "Low" to "High".
(High: 5-30VDC, Low: Max. 2VDC)

- **Solid state input signal**

Input signal generated by transistors of semiconductor circuit (Proximity sensor, Photo sensor, Rotary encoder, Fiber optic cable sensor, etc.).

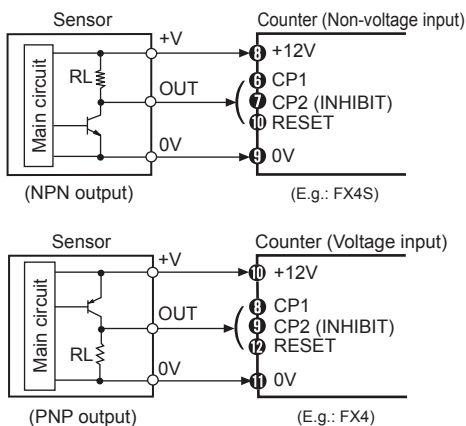

- **Contact input signal**

Contact input signal generated by micro S/W, relay, push button, etc.

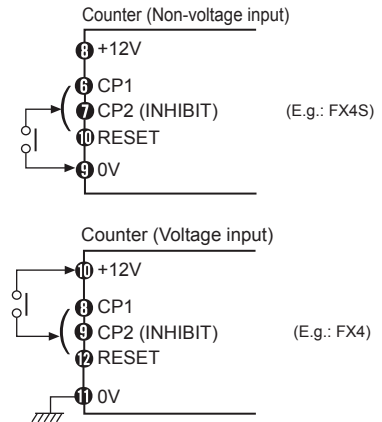

※Set max. counting speed 1 or 30cps to use relay contact signal as input signal source.

◎ **Output**

- **Count up**

A state that output part started operation after counted value reaching to SV.

- **Retained output**

Output status that starts operation once counted value reaches SV, and maintains producing output signal until reset signal applied.

- **One-shot output**

After counting up, operating output for one-shot time period, returning back to its old position.
(Set one-shot time with Time VR on the front or in setting mode.)

- **Solid state output**

An output signal that generated by transistors.

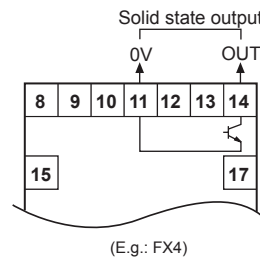

- **NPN open collector output**

The solid state output which is open between collector of transistor and +V power terminal.

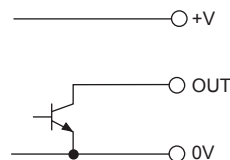

● Allowable inflow current

The maximum permissible limit of current that transistor can stand with when load is connected to SSR. (Max. allowable inflow current is under 100mA)

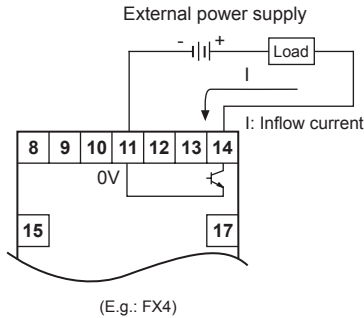

● Allowable voltage

The maximum allowable voltage that is receivable for transistor to operate itself when load is connected to SSR, and the max. allowable voltage is 30VDC.

● Relay contact output

Output signal generated by built-in relay contactor inside counter.

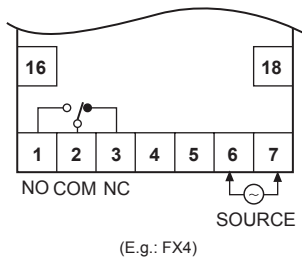

◎ Contact organization

● SPST (Single Pole Single Throw)

Organized one COM and one a-contact or b-contact. Indicates as SPST (1a) or SPST (1b).

● SPDT (Single Pole Double Throw)

Organized one COM and one a-contact and one b-contact. Indicates as SPDT (1a1b) or SPDT (1c).

● DPST (Double Pole Single Throw)

Organized two COMs and two a-contact or b-contact. Indicates as DPST (2a) or DPST (2b).

● DPDT (Double Pole Double Throw)

Organized two COMs and two a-contact and two b-contact. Indicates as DPDT (2a2b) or DPDT (2c).

SPST (1a) (Single Pole Single Throw)	
SPST (1b) (Single Pole Single Throw)	
SPDT (1a1b) or SPDT (1c) (Single Pole Double Throw)	
DPST (2a) (Double Pole Single Throw)	
DPST (2b) (Double Pole Single Throw)	
DPDT (2a2b) or DPDT (2c) (Double Pole Double Throw)	

■ Proper Usage

Several problems may happen in those conditions below, appropriate countermeasures are required.

◎ Signal input line

- Keep signal input wire short enough; otherwise input part of counter will get more impedance.
- If using SSR as input source with input speed under 30cps, set counting speed 30cps so that it can be strong on noise.
- If using relay contact as input signal source, make sure to use the contact with high reliability.
- Do not set counting speed too high when counting relay contact signal. Set counting speed to 1 or 30cps.
- If there are any devices that generates arc with its relay operation, put in surge absorbers.
- Be careful with turning input signal source's power ON or OFF when counter power is on. These can cause transient pulse and it can flow into counter.
- Input signal line should be separated with power line for wiring.
- When input signal wire is needed to be long, use shield wire and it should be separately grounded.

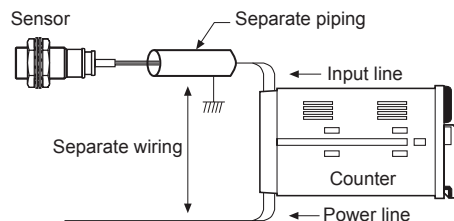

(A) Photoelectric Sensors
(B) Fiber Optic Sensors
(C) Door/Area Sensors
(D) Proximity Sensors
(E) Pressure Sensors
(F) Rotary Encoders
(G) Connectors/ Connector Cables/ Sensor Distribution Boxes/Sockets
(H) Temperature Controllers
(I) SSRs / Power Controllers
(J) Counters
(K) Timers
(L) Panel Meters
(M) Tacho / Speed / Pulse Meters
(N) Display Units
(O) Sensor Controllers
(P) Switching Mode Power Supplies
(Q) Stepper Motors & Drivers & Controllers
(R) Graphic/ Logic Panels
(S) Field Network Devices
(T) Software

Technical Description

◎ Power supply

- Separate counter power line with other high- voltage wire and wrap the power line with pipe separately.
- When inductive load (motor, solenoid, magnet) is installed, put noise filter on power part.
- It is period for stabilizing for the first 100ms after power is on. It may not operate regularly with input signal during that time.

And it also has unstable period of voltage drop for 500ms after power is OFF.

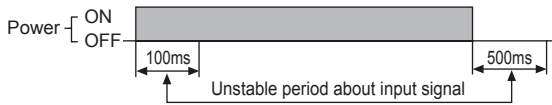

- Obey allowable voltage range for power source, and supply power to S/W, etc. at a time so that no chattering happens.



◎ Noise

- If impulse noise happens, put 0.1 to 1 μ F of D.C condenser in power terminal.
- When testing inner voltage, impulse and insulation resistance after put them together in control board,
 - 1) Separate this product from circuit.
 - 2) Make every terminal disconnected.
(It is to stop part of devices that have problem with inner pressure, insulation, etc. damaging to other parts.)
- If it suddenly stops operating (displaying wrong value or not even doing it at all), reboot it and it will work normally. This happens when strong noise flow into inner micro computer (Micom), so put surge absorber to both side of load.

◎ Environment

Avoid described environment as below.

- A place where components and devices can be stressed by vibrations or impact.
- A place where inflammable and corrosive gas, water or oil is around of or is rather dusty.
- A place where there are machines that create magnetism or electric noise.
- A place of which humidity or temperature exceeds regulation.
- A place where strong alkalis/acids are used.
- A place where there are direct rays of the sun.

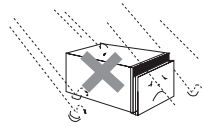

Avoid a place where water or oil is spattering and especially near strong alkalis/acids are being used.

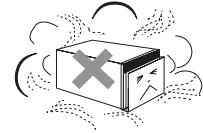

Avoid a place where corrosive or inflammable gas is around of or is rather dusty.

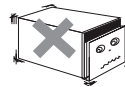

Avoid a place where there is sever vibration or impact.

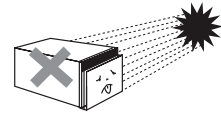

Avoid a place where there is direct rays of the sun.