

## Sensor Distribution Box (M12 4-Pin/5-Pin Connector Type)

### ■ Features

- Easy check operation by operation indicator (red/green)
- Single power operates several sensors
- Convenient wiring and power line
- IP67 protection structure with water-proof cover (IP52 protection structure with protection cover)
- Supports 1-signal, 2-signal (DC 4-wire)

M12 4-pin connector type

M12 5-pin connector type



Cable type

Cable type

M12 5-pin connector type

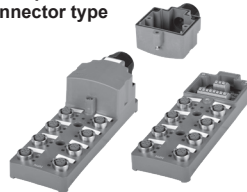

Spring terminal type



Pluggable screw terminal type

Please read "Safety Considerations" in the instruction manual before using.



### ■ Ordering Information

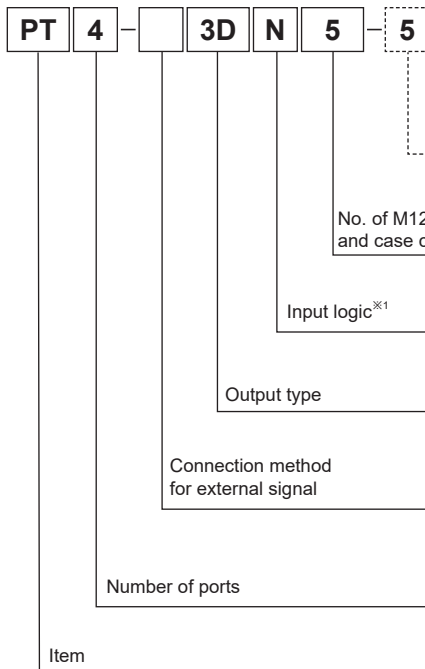

Cable type - Cable length		Pluggable screw terminal type - Hood cover	
M12 4-pin connector	No mark: 5m	No mark: Including hood cover	
M12 5-pin connector	5: 5m 10: 10m	B: No hood cover	
No mark	4-pin (yellow)		
5	5-pin (blue)		
5K	5-pin (black) <sup>※3</sup>		
N	NPN type		
P	PNP type		
2D	DC 2-wire (1-signal)		
3D	DC 3-wire (1-signal)		
4D	DC 4-wire (2-signal) <sup>※2</sup>		
No mark	Cable type		
S	Spring terminal type		
P	Pluggable screw terminal type		
4	4-port		
6	6-port		
8	8-port		
PT	Sensor distribution box		

※1: It is not applied for DC 2-wire (1-signal) type of output.

※2: Only for cable type of M12 5-pin connector type.

※3: Only for spring terminal type, pluggable screw terminal type of M12 5-pin connector type.

### ■ Terminal Specifications for Spring/Pluggable Screw Terminal Type

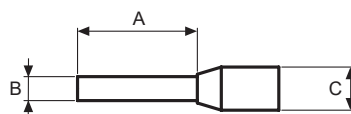

(unit: mm)

		A	B	C	Applicable wire
End Sleeve (ferrule terminal) crimp terminal	Spring terminal type	8	1.3 tot 1.7	3.4 to 3.8	Signal line: AWG22 (0.30mm <sup>2</sup> ) Power line: AWG17 (1mm <sup>2</sup> )
	Pluggable screw terminal type	8 to 10			

SENSORS

CONTROLLERS

MOTION DEVICES

SOFTWARE

(A) Photoelectric Sensors

(B) Fiber Optic Sensors

(C) LiDAR

(D) Door/Area Sensors

(E) Vision Sensors

(F) Proximity Sensors

(G) Pressure Sensors

(H) Rotary Encoders

(I) Connectors/  
Connector Cables/  
Sensor Distribution  
Boxes/ Sockets

## ■ Specifications

### ○ M12 4-pin connector type

Model	NPN type	PT4-2D	PT4-3DN	PT6-2D	PT6-3DN	PT8-2D	PT8-3DN	
	PNP type	—	PT4-3DP	—	PT6-3DP	—	PT8-3DP	
Port	4-port			6-port		8-port		
Output type <sup>※1</sup>	2-wire (1-signal),		3-wire (1-signal)	2-wire (1-signal),		3-wire (1-signal)		
Power supply	12-24VDC <sup>—</sup> (10-30VDC <sup>—</sup> )							
Rated current	2A (per signal), 4A (per port), 10A (total)							
Leakage current	Max. 0.5mA							
Connection life cycle	Min. 200 operations							
Insulation resistance	Over 50MΩ (at 500VDC megger)							
Dielectric strength	1,500VAC 50/60Hz for 1 min							
Vibration	1mm amplitude at frequency of 10 to 55Hz (for 1 min) in each X, Y, Z direction for 2 hours							
Shock	500m/s <sup>2</sup> (approx. 50G) in each X, Y, Z direction for 3 times							
Indicator	Power indicator: green LED, operation indicator: red LED							
Environment	Ambient temp.	-25 to 75, storage: -30 to 80						
	Ambient humi.	35 to 95%RH, storage: 35 to 95%RH						
Protection structure <sup>※2</sup>	IP67 (IEC standard/when mounting connector, waterproof cover) or IP52 (IEC standard/when mounting protection cover)							
Material	Case: polybutylene terephthalate (G15%), general cable (gray): polyvinyl chloride (PVC)							
Approval	CE							
Weight <sup>※3, ※4</sup>	Approx. 700g (approx. 660g)			Approx. 720g (approx. 680g)		Approx. 820g (approx. 780g)		

※1: Connect the sensor to the proper output type.

※2: This is not applicable when connectors and protection/waterproof covers are not mounted.

※3: The weight includes packaging. The weight in parenthesis is for unit only.

※4: The weights are for 5m cable.

※Environment resistance is rated at no freezing or condensation.

### ○ M12 5-pin connector type

Type		Cable type						Spring terminal type <sup>※1</sup>			Pluggable screw terminal type <sup>※1</sup>		
Model	NPN type	PT4-3DN5-□	PT4-4DN5-□	PT6-3DN5-□	PT6-4DN5-□	PT8-3DN5-□	PT8-4DN5-□	PT4-S3DN□	PT6-S3DN□	PT8-S3DN□	PT4-P3DN□□	PT6-P3DN□□	PT8-P3DN□□
	PNP type	PT4-3DP5-□	PT4-4DP5-□	PT6-3DP5-□	PT6-4DP5-□	PT8-3DP5-□	PT8-4DP5-□	PT4-S3DP□	PT6-S3DP□	PT8-S3DP□	PT4-P3DP□□	PT6-P3DP□□	PT8-P3DP□□
Port	4-port		6-port		8-port		4-port			8-port			
Output type <sup>※2</sup>	3-wire (1-signal)		4-wire (2-signal)		3-wire (1-signal)		4-wire (2-signal)		3-wire (1-signal)				
Power supply	12-24VDC <sup>—</sup>												
Rated current	2A (per signal), 4A (per port), 10A (total)						2A (per signal), 2A (per port), 7A (total)						
Leakage current	Max. 0.5mA						—						
Current consumption	Max. 5mA												
Connection life cycle	Min. 200 operations												
Insulation resistance	Over 100MΩ (at 500VDC megger)												
Dielectric strength	500VAC 50/60Hz for 1 min												
Vibration	3mm amplitude at frequency of 10 to 55Hz (for 1 min) in each X, Y, Z direction for 2 hours												
Shock	500m/s <sup>2</sup> (approx. 50G) in each X, Y, Z direction for 3 times												
Indicator	Power indicator: red LED, operation indicator: green LED												
Environment	Ambient temp.	-25 to 75, storage: -30 to 80											
	Ambient humi.	35 to 85%RH, storage: 35 to 85%RH											
Protection structure <sup>※3</sup>	IP67 (IEC standard/when mounting connector, waterproof cover) or IP52 (IEC standard/when mounting protection cover)												
Material	Case: polybutylene terephthalate (G15%), name plate: polycarbonate, general cable (black): polyvinyl chloride (PVC)						Case: polybutylene terephthalate (g15%), name plate: polycarbonate, cover: polybutylene terephthalate (g15%), cover nut: polyamide 6 (g15%)						
Approval	CE												
Weight <sup>※4, ※5</sup>	Approx. 1100g (approx. 900g)	Approx. 1400g (approx. 1200g)	Approx. 1130g (approx. 930g)	Approx. 1430g (approx. 1230g)	Approx. 1160g (approx. 960g)	Approx. 1460g (approx. 1260g)	Approx. 270g (approx. 140g)	Approx. 292g (approx. 165g)	Approx. 314g (approx. 190g)	Approx. 280g (approx. 150g)	Approx. 302g (approx. 175g)	Approx. 334g (approx. 210g)	

※1: Applicable cable out diameter is 10.5mm±0.3 for Spring/Pluggable screw terminal type.

※2: Connect the sensor to the proper output type.

※3: This is not applicable when connectors and protection/waterproof covers are not mounted.

※4: The weight includes packaging. The weight in parenthesis is for unit only.

※5: Cable type weights are based on 5m cable.

※Environment resistance is rated at no freezing or condensation.

# Sensor Distribution Box

## ■ Dimensions

※The below dimensions are based on 8-port.

(unit: mm)

### ○ Cable type

#### ● M12 4-pin connector type

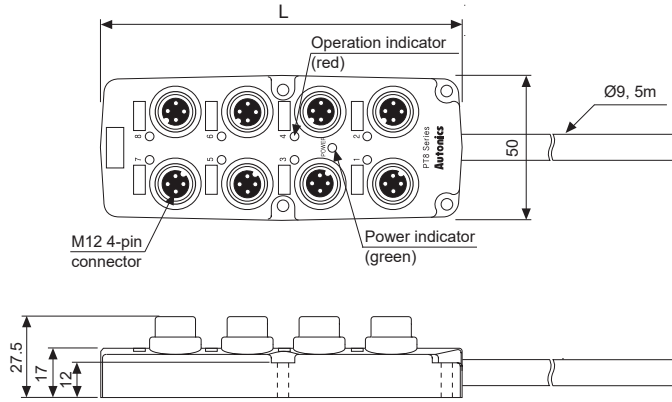

Model	L
PT4-□□	73
PT6-□□	98
PT8-□□	123

※Cable specification:  $\varnothing 9$ , 10-wire (conductor cross section:  $0.3\text{mm}^2$ , insulator diameter:  $\varnothing 1.67$ )

#### ● Panel cut-out

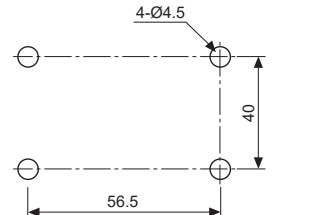

※Mounting holes are same as 4, 6, 8-port.

#### ● M12 5-pin connector type

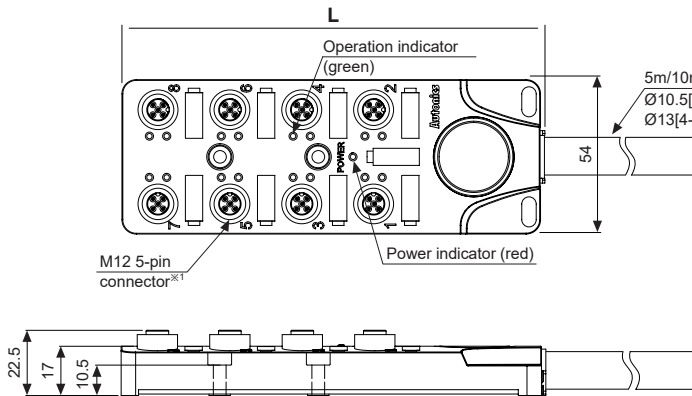

Model	L
PT4-□□□□	95
PT6-□□□□	120
PT8-□□□□	145

#### ● Panel cut-out

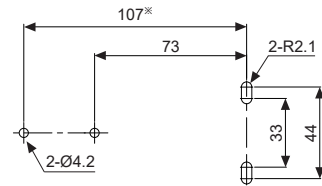

※Except 4-port model.

※1: When connecting L type connectors, connection direction may be different by the manufacturers of the connector.

### ○ Spring terminal type/Pluggable screw terminal type

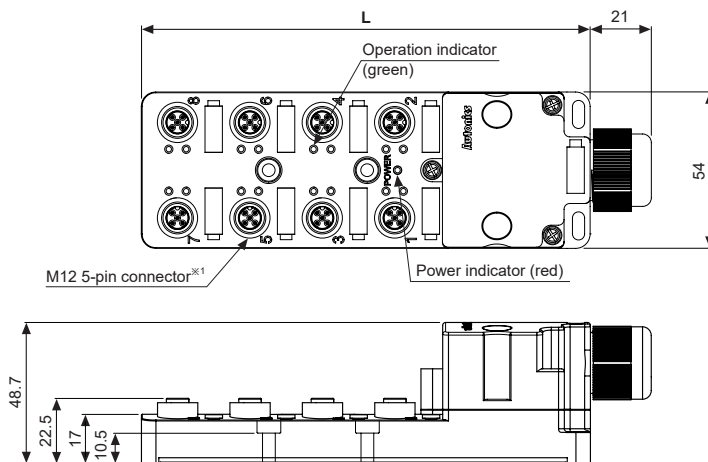

※The below dimensions are based on 8-port.  
(unit: mm)

Model	L
PT4-S□□□	105
PT4-P□□□-□	105
PT6-S□□□	130
PT6-P□□□-□	130
PT8-S□□□	155
PT8-P□□□-□	155

#### ● Panel cut-out

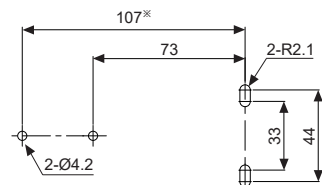

※Except 4-port model.

※1: When connecting L type connectors, connection direction may be different by the manufacturers of the connector.

SENSORS
CONTROLLERS
MOTION DEVICES
SOFTWARE

(A) Photoelectric Sensors
(B) Fiber Optic Sensors
(C) LIDAR
(D) Door/Area Sensors
(E) Vision Sensors
(F) Proximity Sensors
(G) Pressure Sensors
(H) Rotary Encoders

(I) Connectors/ Connector Cables/ Sensor Distribution Boxes/ Sockets
---

# PT Series

## Inner Connections for Spring/Pluggable Screw Terminal Type

### Spring terminal type

#### PT4-S3D

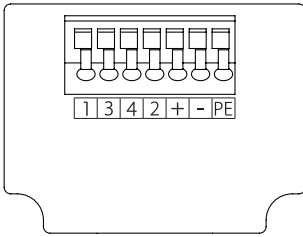

#### PT6-S3D

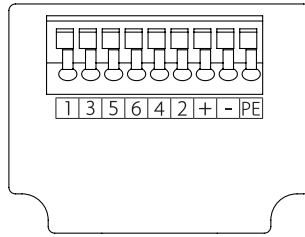

#### PT8-S3D

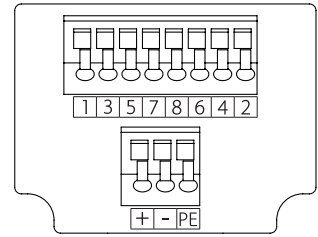

### Pluggable screw terminal type

#### PT4-P3D

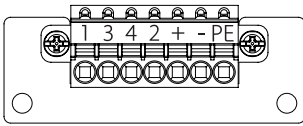

#### PT6-P3D

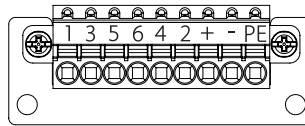

#### PT8-P3D

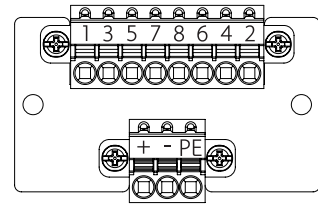

## Connecting Crimp Terminals for Spring/Pluggable Screw Terminal Type

### Spring terminal type

Remove bolts on the terminal cover using a tool such as a screwdriver and open the cover.

#### • Connection

- 1) Push the end sleeve (ferrule) crimp terminal towards direction ① to complete the connection.

#### • Removal

- 1) Press and hold the catch above the terminal in direction ② with a flat-head screwdriver.
- 2) Pull and remove the end sleeve (ferrule) crimp terminal towards direction ③.

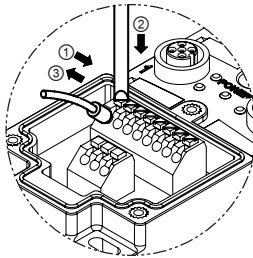

### Pluggable screw terminal type

Remove bolts on the terminal cover using a tool such as a screwdriver and open the cover. Remove the terminal also as above order.

#### • Connection

- 1) Push the end sleeve (ferrule) crimp terminal towards direction ① to complete the connection.

#### • Removal

- 1) Press and hold the catch above the terminal in direction ② with a flat-head screwdriver.
- 2) Pull and remove the end sleeve (ferrule) crimp terminal towards direction ③.

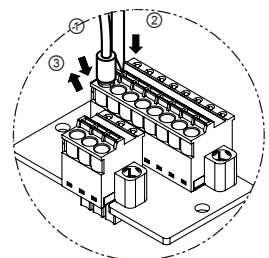

## Example of Connections

### Connection with cable type sensor

It is available to connect a cable type sensor proximity sensor (PRW Series) with a sensor distribution box directly. When installation distance is longer, use a connector cable.

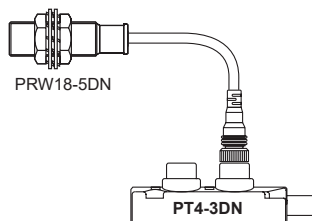

### Connection with connector type sensor

When connecting a connector type proximity sensor (PRCM Series) with a sensor distribution box, use only connector cable.

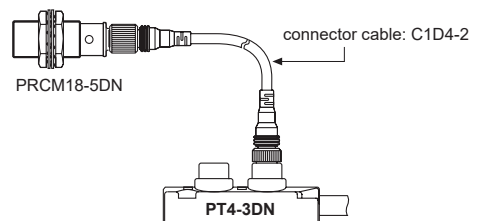

# Sensor Distribution Box

(unit: mm)

## ■ Sold Separately

### ○ Protection cover (CAP-PT)

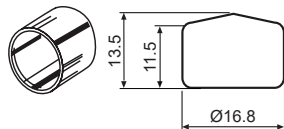

- ※This protection cover is used for protecting connection holes from dust or particle, etc. Please push it into hole.
- ※If using protection covers, protection structure of the sensor distribution box is IP52.

### ○ Waterproof cover (P96-M12-1)

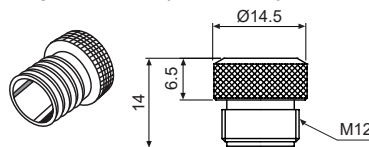

- ※This waterproof cover is used for protecting unused connection hole from water or oil, etc. Please tighten it when applying to the ports.
- ※If using waterproof covers, protection structure of the sensor distribution box is IP67.

## ■ Connectable Autonics Proximity Sensors, Photoelectric Sensors, Door/Area Sensors

Sensor distribution box	Input logic	Proximity sensor	Photoelectric sensor	Door/Area sensor	Connection method
PT□-2D	DC 2-wire	PRCMT12-2/4DO, DC PRCMT18-5/8DO, DC PRCMT30-10/15DO, DC	PRDCMT12-4/8DO, DC PRDCMT18-7/14DO, DC PRDCMT30-15/25DO, DC	—	Use connector cable
		PRWT12-2/4DO, DC PRWT18-5/8DO, DC PRWT30-10/15DO, DC	PRDWT12-4/8DO, DC PRDWT18-7/14DO, DC PRDWT30-15/25DO, DC		Connect directly, Use connector cable
PT□-3DN PT□-3DN5-□ PT□-□3DN5	DC 3-wire NPN output type	PRCM12-2/4DN, DN2 PRCM18-5/8DN, DN2 PRCM30-10/15DN, DN2 PRCML18-5/8DN, DN2 PRCML30-10/15DN, DN2	PRDCM12-4/8DN, DN2 PRDCM18-7/14DN, DN2 PRDCM30-15/25DN, DN2 PRDCML12-4/8DN, DN2 PRDCML18-7/14DN, DN2 PRDCML30-15/25DN, DN2	BRP3M-MDT-C BR3M-MDT-C	Use connector cable
		PRW12-2/4DN, DN2 PRW18-5/8DN, DN2 PRW30-10/15DN, DN2 PRWL18-5/8DN, DN2 PRWL30-10/15DN, DN2	PRDW12-4/8DN, DN2 PRDW18-7/14DN, DN2 PRDW30-15/25DN, DN2 PRDWL12-4/8DN, DN2 PRDWL18-7/14DN, DN2 PRDWL30-15/25DN, DN2	—	Connect directly, Use connector cable
PT□-3DP PT□-3DP5-□ PT□-□3DP5	DC 3-wire PNP output type	PRCM12-2/4DP, DP2 PRCM18-5/8DP, DP2 PRCM30-10/15DP, DP2 PRCML18-5/8DP, DP2 PRCML30-10/15DP, DP2	PRDCM12-4/8DP, DP2 PRDCM18-7/14DP, DP2 PRDCM30-15/25DP, DP2 PRDCML12-4/8DP, DP2 PRDCML18-7/14DP, DP2 PRDCML30-15/25DP, DP2	BRP3M-MDT-C-P BR3M-MDT-C-P	Use connector cable
		PRW12-2/4DP, DP2 PRW18-5/8DP, DP2 PRW30-10/15DP, DP2 PRWL18-5/8DP, DP2 PRWL30-10/15DP, DP2	PRDW12-4/8DP, DP2 PRDW18-7/14DP, DP2 PRDW30-15/25DP, DP2 PRDWL12-4/8DP, DP2 PRDWL18-7/14DP, DP2 PRDWL30-15/25DP, DP2	—	Connect directly, Use connector cable
PT□-4DN5-□ PT□-□4DN5	DC 4-wire NPN output type	—	BRP100-DDT-C, BR100DDT-C, BRP400DDT-C, BR400DDT-C, BRP200DDTN-C, BR200DDTN-C	BWC40-□H, HD BWC80-□H, HD BW20-□ BW40-□	Connect directly, Use connector cable
PT□-4DP5-□ PT□-□4DP5	DC 4-wire PNP output type	—	BRP100-DDT-C-P, BR100-DDT-C-P, BRP400DDT-C-P, BR400DDT-C-P, BRP200DDTN-C-P, BR200DDTN-C-P	BW20-□P, BW40-□P	Connect directly, Use connector cable

※Standard cable type sensors can also connect a sensor distribution box by using plug type connector cable.

SENSORS

CONTROLLERS

MOTION DEVICES

SOFTWARE

(A) Photoelectric Sensors

(B) Fiber Optic Sensors

(C) LIDAR

(D) Door/Area Sensors

(E) Vision Sensors

(F) Proximity Sensors

(G) Pressure Sensors

(H) Rotary Encoders

(I) Connectors/  
Connector Cables/  
Sensor Distribution  
Boxes/ Sockets

## Connections

### M12 4-pin connector type

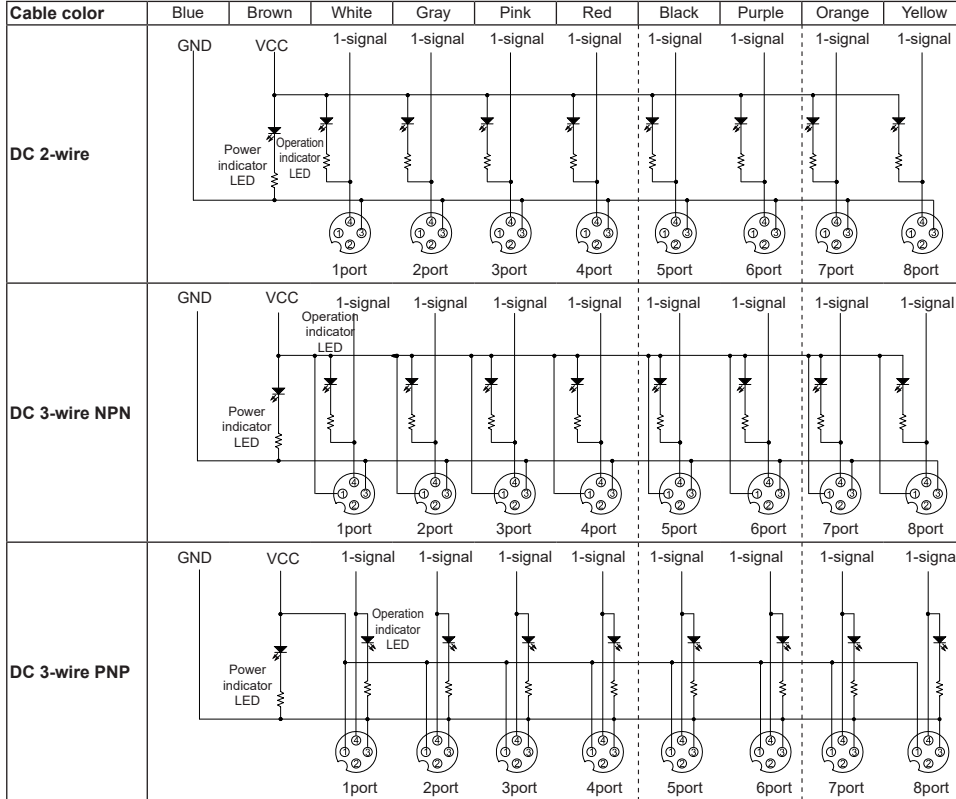

### M12 5-pin connector type

#### 3-wire (1-signal)

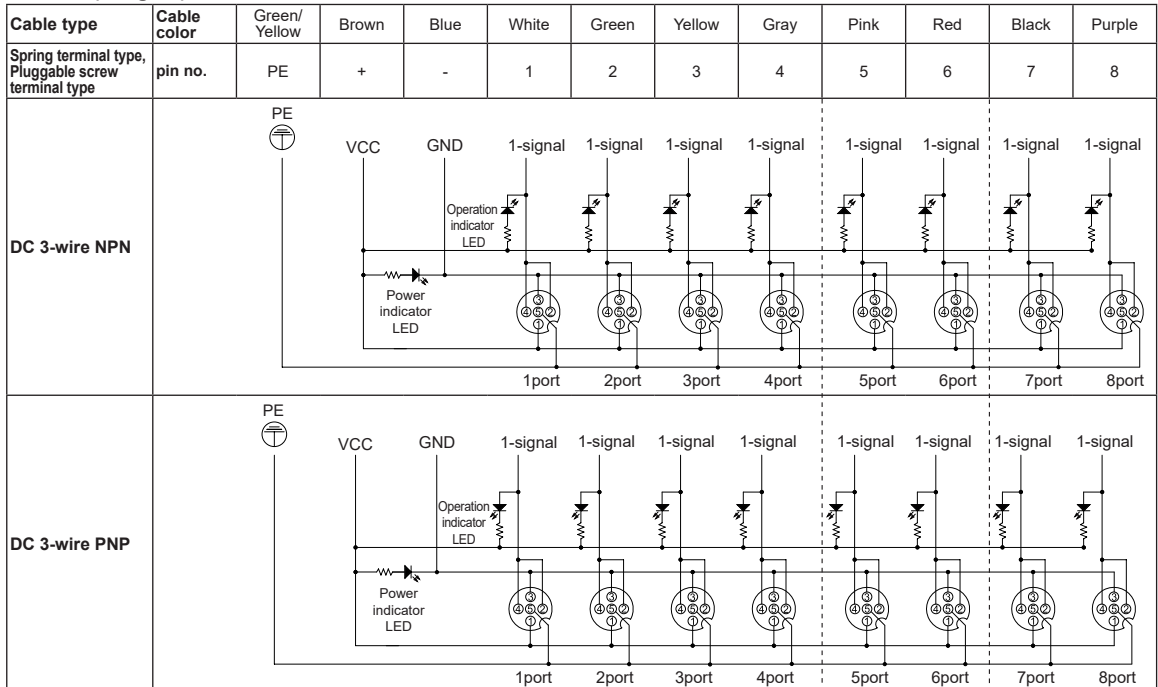

# Sensor Distribution Box

## Connections

● M12 5-pin connector type

● 4-wire (2-signal)

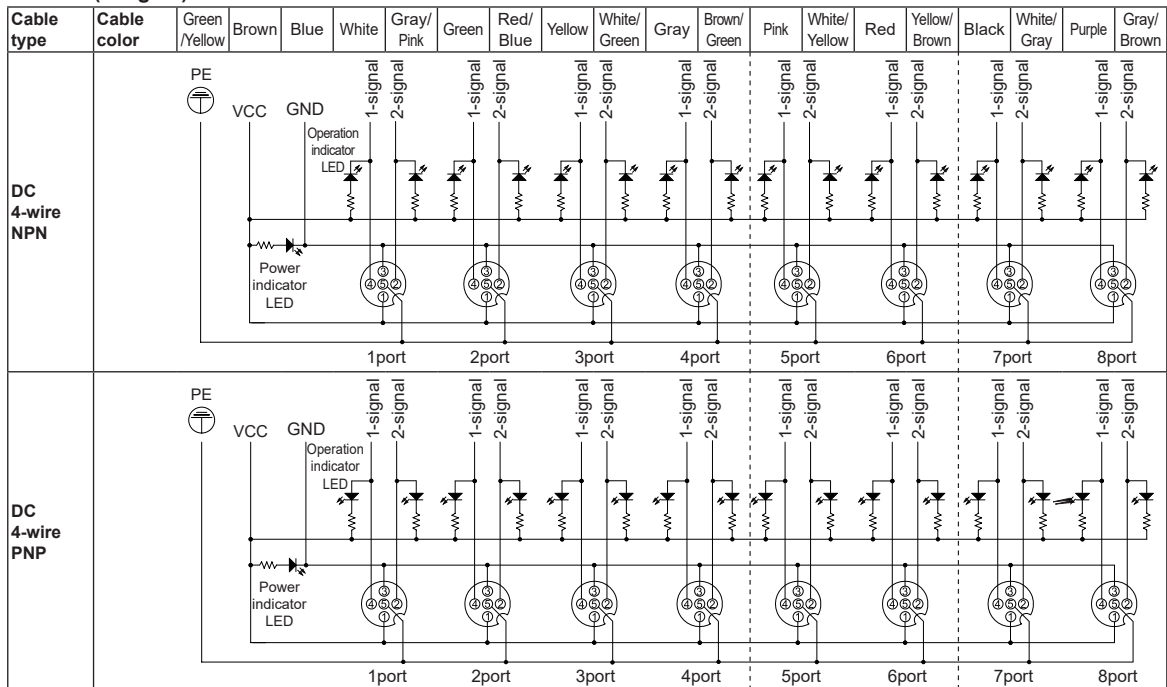

## Cautions during Use

1. This connection box is only for DC. Do not use this unit for AC.
2. Use DC 2-wire, DC 3-wire, DC 4-wire separately. DC 3-wire, DC 4-wire are separated by NPN type and PNP type.
3. Do not use the same conduit with cord of this unit and electric power line and power line. Also avoid the same connection.
4. Be sure that wire power cable (brown: +, blue: -) properly.
5. Check the voltage variation range of power not to over the rated specifications for power input.
6. In case of M12 4-pin connector type, the power indicator (green LED) does not operate when polarity is not correctly connected.
7. In case of M12 5-pin connector type, Tighten the screws and connector with the proper tightening strength.  
(M4 mounting screw: max. 1.2N·m / M12 Connector: 0.6 to 0.7N·m)  
When tightening is bad, protection is not effective and it may loose by vibration.
8. If transceiver is close to wire connections, it may cause malfunction.
9. When take out the connector from the box, cut off the power.
10. It might cause malfunction, if particle of metal etc. inflow in to engaging.
11. Do not use this unit when external force loaded on contact block and connection of cover. It may cause loss of efficiency of protection.
12. Follow the connections when wiring the signals. After connecting loads, operate proximity sensors.
13. Check the operation indicator when operating the sensors.
14. Do not use in place there are water or oil etc.
15. Main body is made by plastic, therefore do not put heavy load on this product.
16. Please avoid below environment for long-term storage.
  - ① Lots of dust or high humidity
  - ② Ammonia or sulfide gas

SENSORS

CONTROLLERS

MOTION DEVICES

SOFTWARE

(A) Photoelectric Sensors

(B) Fiber Optic Sensors

(C) LiDAR

(D) Door/Area Sensors

(E) Vision Sensors

(F) Proximity Sensors

(G) Pressure Sensors

(H) Rotary Encoders

(I) Connectors/ Connector Cables/ Sensor Distribution Boxes/ Sockets