

Autonics

**Sensor Distribution Box
(M12 5-Pin Connector Type)
PT SERIES**

INSTRUCTION MANUAL

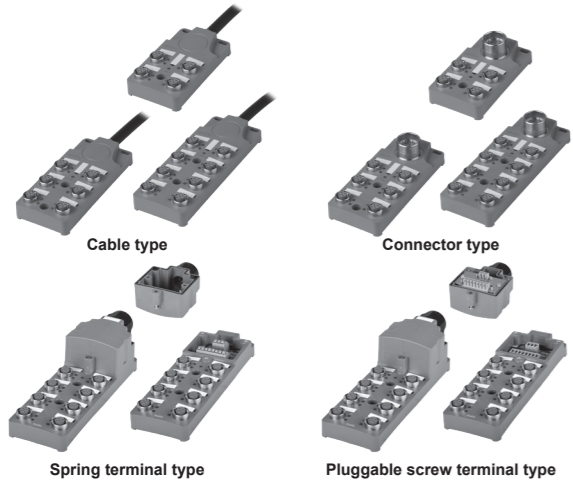

Thank you for choosing our Autonics product.
Please read the following safety considerations before use.

■ Safety Considerations

※Please observe all safety considerations for safe and proper product operation to avoid hazards.

※⚠ symbol represents caution due to special circumstances in which hazards may occur.

⚠ Warning Failure to follow these instructions may result in serious injury or death.

⚠ Caution Failure to follow these instructions may result in personal injury or product damage.

⚠ Warning

- Fail-safe device must be installed when using the unit with machinery that may cause serious injury or substantial economic loss.** (e.g. nuclear power control, medical equipment, ships, vehicles, railways, aircraft, combustion apparatus, safety equipment, crime/disaster prevention devices, etc.) Failure to follow this instruction may result in fire, personal injury, or economic loss.
- Do not connect, repair, or inspect the unit while connected to a power source.** Failure to follow this instruction may result in fire.
- Check 'Connections' before wiring.** Failure to follow this instruction may result in fire.
- Do not disassemble or modify the unit.** Failure to follow this instruction may result in fire.

⚠ Caution

- Use the unit within the rated specifications.** Failure to follow this instruction may result in fire or product damage.
- Use dry cloth to clean the unit, and do not use water or organic solvent.** Failure to follow this instruction may result in fire.
- Do not use the unit in the place where flammable/explosive/corrosive gas, humidity, direct sunlight, radiant heat, vibration, impact, or salinity may be present.** Failure to follow this instruction may result in fire or explosion.
- Keep metal chip, dust, and wire residue from flowing into the unit.** Failure to follow this instruction may result in fire or product damage.

■ Ordering Information

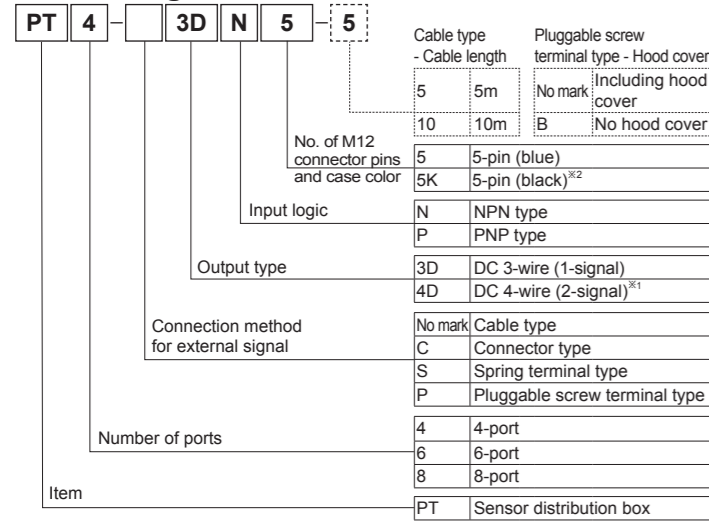

※1: Only for cable type and connector type.
※2: Only for spring terminal type, pluggable screw terminal type.

**■ Terminal Specifications
for Spring/Pluggable Screw Terminal Type**

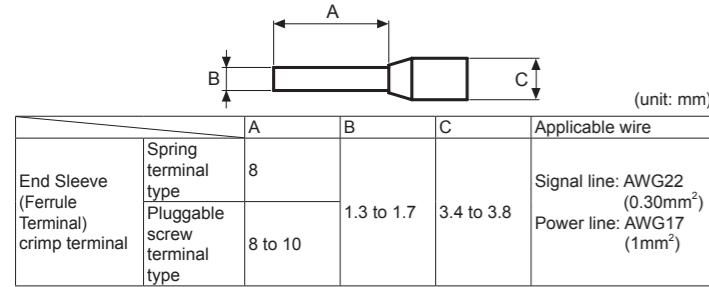

※The above specifications are subject to change and some models may be discontinued without notice.
※Be sure to follow cautions written in the instruction manual and the

■ Specifications

Type	M12 5-pin connector type												Cable type				Spring terminal type ^{※1}				Pluggable screw terminal type ^{※1}											
Model	NPN type		PT4-3DN5-□		PT4-4DN5-□		PT6-3DP5-□		PT6-4DP5-□		PT8-3DP5-□		PT8-4DP5-□		PT4-S3DN□		PT6-S3DN□		PT8-S3DN□		PT4-P3DN□		PT6-P3DN□		PT8-P3DN□							
Port	4-port		4-wire (1-signal)		4-wire (2-signal)		3-wire (1-signal)		3-wire (2-signal)		4-wire (1-signal)		4-wire (2-signal)		4-port		6-port		8-port		4-port		6-port		8-port							
Output type ^{※2}	3-wire (1-signal)		4-wire (2-signal)		4-wire (1-signal)		4-wire (2-signal)		3-wire (1-signal)		3-wire (2-signal)		4-wire (1-signal)		4-wire (2-signal)		3-wire (1-signal)		3-wire (2-signal)		4-wire (1-signal)		4-wire (2-signal)		4-wire (1-signal)							
Power supply	12-24VDC=																															
Rated current	2A (per signal), 4A (per port), 10A (total)																															
Leakage current	Max. 0.5mA																															
Current consumption	Max. 5mA																															
Connection life cycle	Min. 200 operations																															
Insulation resistance	Over 100MΩ (at 500VDC megger)																															
Dielectric strength	500VAC 50/60Hz for 1 min																															
Vibration	3mm amplitude at frequency of 10 to 55Hz (for 1 min) in each X, Y, Z direction for 2 hours																															
Shock	500m/s ² (approx. 50G) in each X, Y, Z direction for 3 times																															
Indicator	Power indicator: Red LED, Operation indicator: Green LED																															
Environment	Ambient temp. -25 to 75°C, storage: -30 to 80°C Ambient humi. 35 to 85%RH, storage: 35 to 85%RH																															
Protection ^{※3}	IP67 (IEC Standards/when mounting connector, waterproof cover) or IP52 (IEC Standards/when mounting protection cover)																															
Material	Case: Polybutylene terephthalate (G15%), Name Plate: Polycarbonate, General cable (black): Polyvinyl chloride (PVC)												Case: Polybutylene terephthalate (G15%), Name Plate: Polycarbonate, Cover: Polybutylene terephthalate (G15%), Cover nut: Polyamide 6 (G15%).																			
Approval	CE																															
Weight ^{※4, ※5}	Approx. 1100g (approx. 900g)	Approx. 1400g (approx. 1200g)	Approx. 1130g (approx. 930g)	Approx. 1430g (approx. 1230g)	Approx. 1160g (approx. 960g)	Approx. 1460g (approx. 1260g)	Approx. 230g (approx. 120g)	Approx. 235g (approx. 125g)	Approx. 260g (approx. 150g)	Approx. 290g (approx. 180g)	Approx. 270g (approx. 140g)	Approx. 292g (approx. 155g)	Approx. 314g (approx. 190g)	Approx. 280g (approx. 150g)	Approx. 302g (approx. 175g)	Approx. 334g (approx. 210g)	Approx. 265g (approx. 150g)	Approx. 290g (approx. 180g)	Approx. 270g (approx. 140g)	Approx. 292g (approx. 155g)	Approx. 314g (approx. 190g)	Approx. 280g (approx. 150g)	Approx. 302g (approx. 175g)	Approx. 334g (approx. 210g)	Approx. 265g (approx. 150g)	Approx. 290g (approx. 180g)	Approx. 270g (approx. 140g)	Approx. 292g (approx. 155g)	Approx. 314g (approx. 190g)	Approx. 280g (approx. 150g)	Approx. 302g (approx. 175g)	Approx. 334g (approx. 210g)

※1: Applicable cable out diameter is 10.5mm±0.3 for Spring/Pluggable screw terminal type.
※2: This is not applicable when connectors and protection/waterproof covers are not mounted.
※3: Cable type weights are based on 5m cable.
※4: Connect the sensor to the proper output type.
※5: The weight includes packaging. The weight in parenthesis is for unit only.
※Environment resistance is rated at no freezing or condensation.

■ Inner Connections for Spring/Pluggable Screw Terminal Type

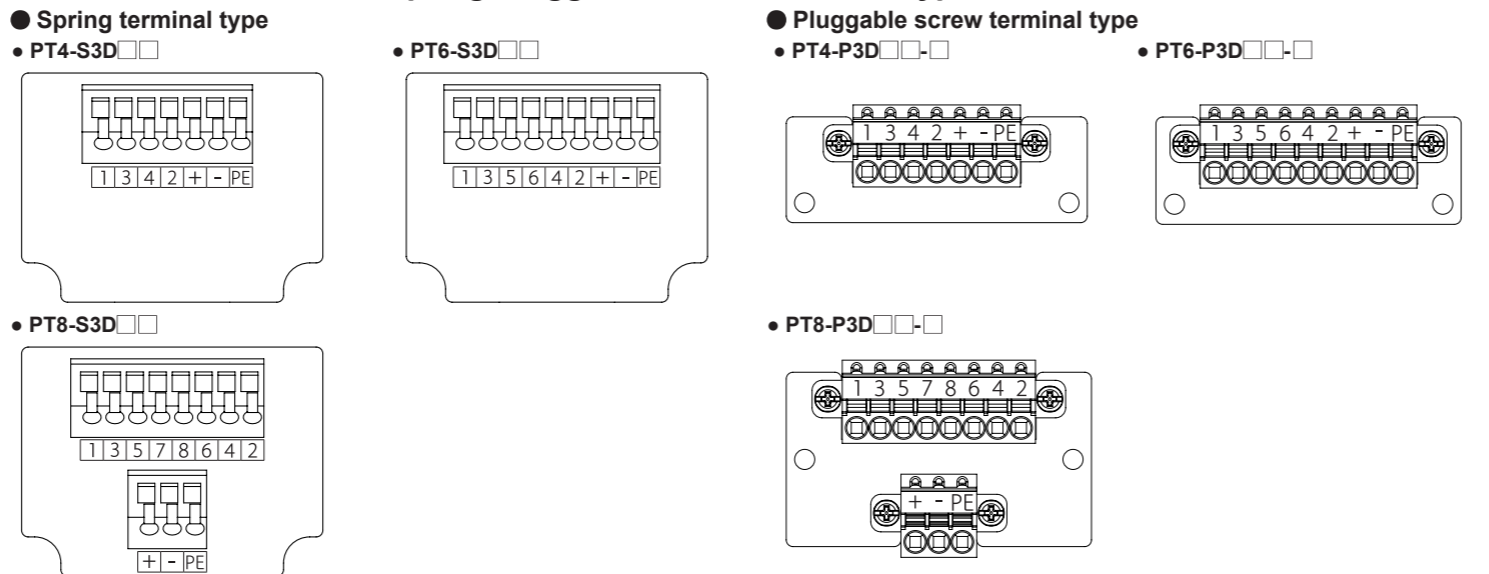

■ Connections

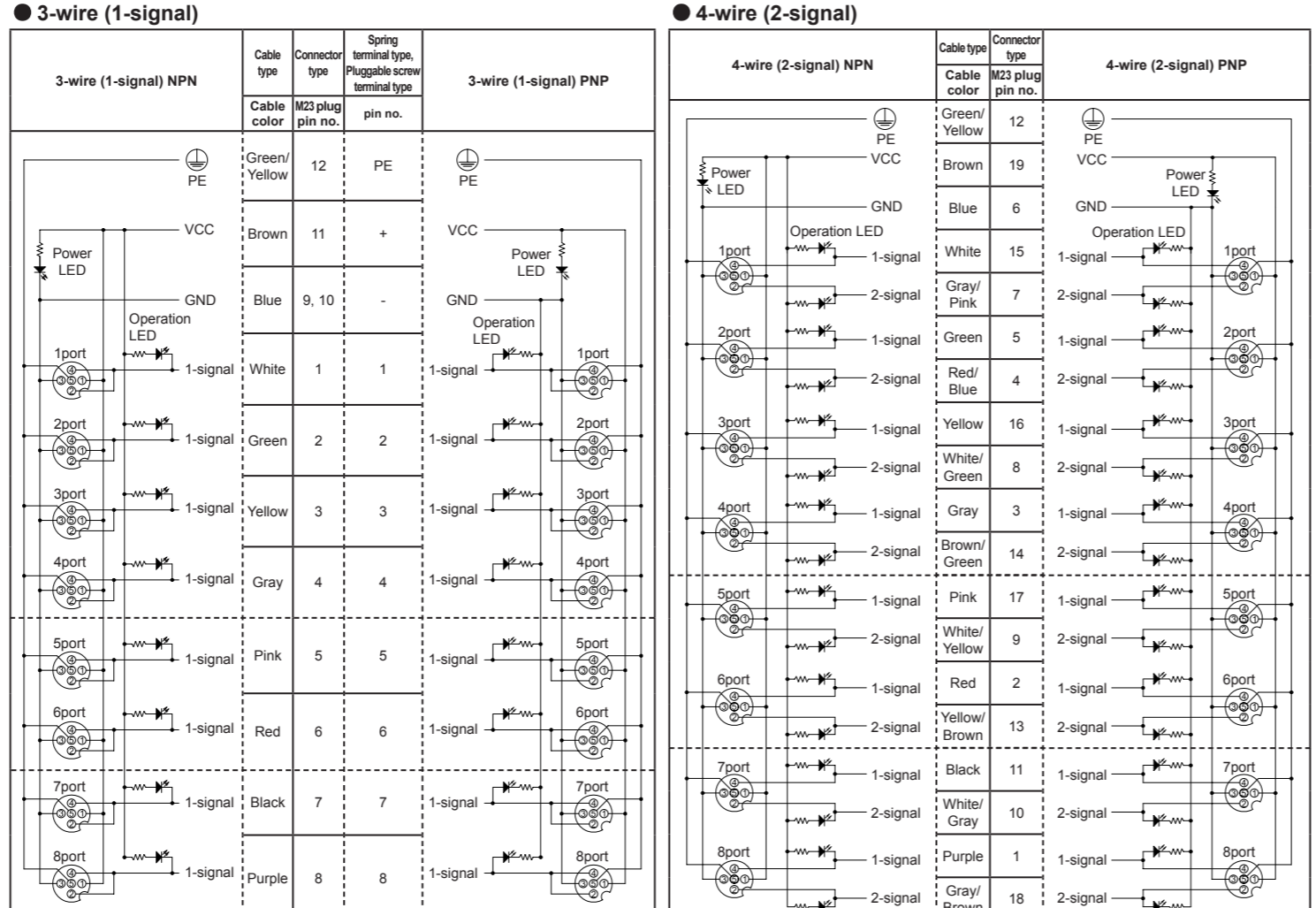

■ Dimensions

● Cable type

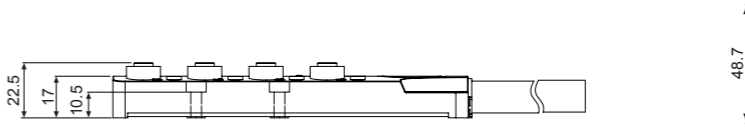
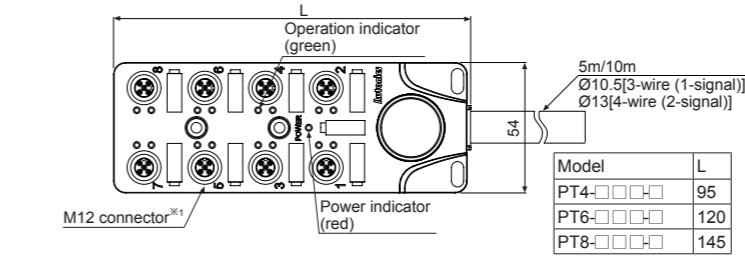

※The dimensions are based on PT8-S□□□□.
※1: When connecting L type connectors, connection direction may be different by the manufacturers of the connector.

● Connector type

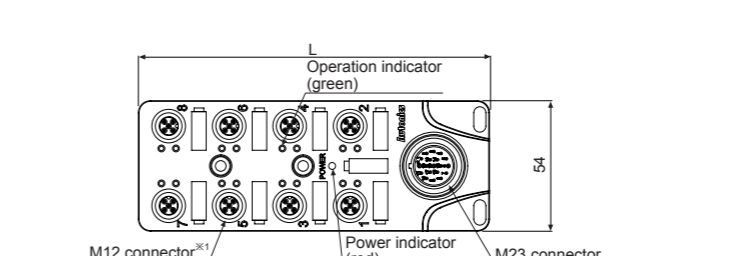

※The dimensions are based on PT8-C□□□□.
※1: When connecting L type connectors, connection direction may be different by the manufacturers of the connector.

● Spring terminal type/Pluggable screw terminal type

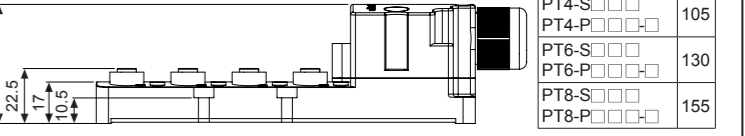
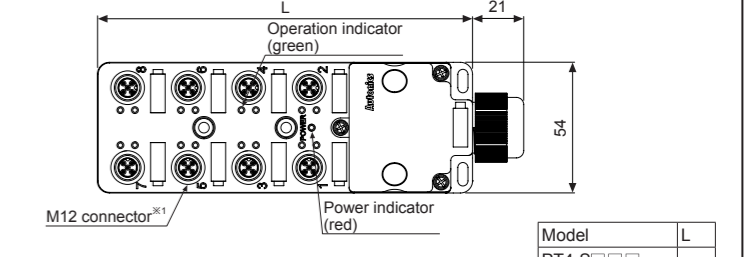

※The dimensions are based on PT8-S□□□□ and PT8-P□□□□.
※1: When connecting L type connectors, connection direction may be different by the manufacturers of the connector.

● Mounting hole

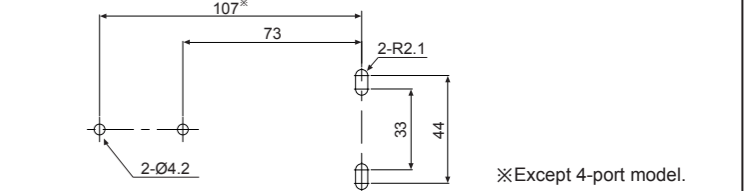

※Except 4-port model.

● Sold separately

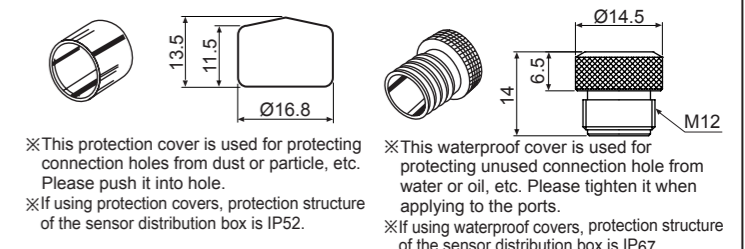

※This protection cover is used for protecting connection holes from dust or particle, etc. Please push it into hole.
※If using protection covers, protection structure of the sensor distribution box is IP52.

※This waterproof cover is used for protecting unused connection hole from water or oil, etc. Please tighten it when applying to the ports.
※If using waterproof covers, protection structure of the sensor distribution box is IP67.

■ Connecting Crimp Terminals for Spring/Pluggable Screw Terminal Type

● Spring terminal type

- Remove bolts on the terminal cover using a tool such as a screwdriver and open the cover.
- Connection
 - 1) Push the end sleeve (ferrule) crimp terminal towards direction ① to complete the connection.
 - Removal
 - 1) Press and hold the catch above the terminal in direction ② with a flat-head screwdriver.
 - 2) Pull and remove the end sleeve (ferrule) crimp terminal towards direction ③.

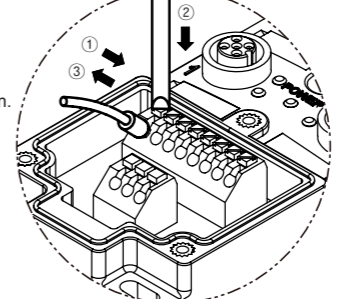

● Pluggable screw terminal type

- Remove bolts on the terminal cover using a tool such as a screwdriver and open the cover. Remove the terminal also as above order.
- Connection
 - 1) Push the end sleeve (ferrule) crimp terminal towards direction ① to complete the connection.
 - Removal
 - 1) Press and hold the catch above the terminal in direction ② with a flat-head screwdriver.
 - 2) Pull and remove the end sleeve (ferrule) crimp terminal towards direction ③.

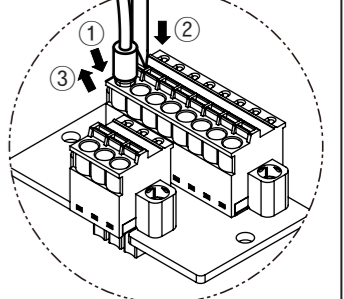

■ M23 Connector Cable (Sold Separately)

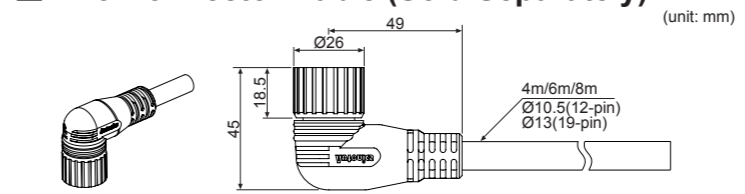

Model	12-pin [for 3-wire (1-signal)]			19-pin [for 4-wire (2-signal)]		
	CLDH12C-040	CLDH12C-060	CLDH12C-080	CLDH19C-040	CLDH19C-060	CLDH19C-080
Pin arrangement						
	Pin no. 1-12			Pin no. 1-19		
Cable length ^{※1}	4m	6m	8m	4m	6m	8m
	Applied model			Applied model		
Connection wiring	Pin no. Cable color AWG			Pin no. Cable color AWG		
	1 White 2 Green 3 Yellow 4 Gray 5 Pink 6 Red 7 Black 8 Purple 9 Blue 10 — 11 Brown 12 Green/Yellow			1 Purple 2 Red 3 Gray 4 Red/Blue 5 Green 6 Blue 7 Gray/Pink 8 White/Green 9 White/Yellow 10 White/Gray 11 Black 12 Green/Yellow 13 Yellow/Brown 14 Brown/Green 15 White 16 Yellow 17 Pink 18 Gray/Brown 19 Brown		

※1: Cable length can be customized.

■ Cautions during Use

- Follow instructions in 'Cautions during Use'. Otherwise, it may cause unexpected accidents.
- 12-24VDC power supply should be insulated and limited voltage/current or Class 2, SELV power supply device.
- Since sensor distribution box is only for DC, do not use for AC.
- Connect sensor after checking whether output is NPN or PNP.
- Operate sensor after connecting load.
- Tighten the mounting screw or connector with following tightening torque.
 - Mounting screw (M4): max. 1.2N·m
 - M12 connector: 0.6 to 0.7N·m
 - M23 connector: 2.0 to 2.5N·m
- Do not pull the cable which is connected to the body.
- 3D not put an object on the body.
- It is hard to maintain protection structure, when consistently using the product with external power applied to the connector joint.
- Keep away from high voltage lines or power lines to prevent inductive noise. In case installing power line and input signal line closely, use line filter or varistor at power line and shielded wire at input signal line. Do not use near the equipment which generates strong magnetic force or high frequency noise.
- If transceiver and sensor distribution box are installed closely, malfunction can occur. This unit may be used in the following environments.
 - ①Indoors (in the environment condition rated in 'Specifications')
 - ②Altitude max. 2,000m
 - ③Pollution degree 2
 - ④Installation category

■ Major Products

- Photoelectric Sensors
- Fiber Optic Sensors
- Door Sensors
- Door Side Sensors
- Area Sensors
- Proximity Sensors
- Pressure Sensors
- Rotary Encoders
- Connectors/Sockets
- Switching Mode Power Supplies
- Control Switches/Lamps/Buzzers
- I/O Terminal Blocks & Cables
- Stepper Motors/Drivers/Motion Controllers
- Graphic/Logic Panels
- Field Network Devices
- Laser Marking System(Fiber, CO₂, Nd:YAG)
- Laser Welding/Cutting System
- Temperature Controllers
- Temperature/Humidity Transducers
- SSRs/Power Controllers
- Counters
- Timers
- Panel Meters
- Tachometers/Pulse(Rate) Meters
- Display Units
- Sensor Controllers

Autonics Corporation
http://www.autonics.com
HEADQUARTERS:
18, Bansong-ro 513 beon-gil, Haeundae-gu, Busan, South Korea, 48002
TEL: 82-51-519-3223
E-mail: sales@autonics.com