

EP58 Series Ø58mm Shaft/Hollow Built-In Absolute Type

Diameter Ø58mm Shaft/Hollow Built-In Type Absolute Rotary Encoder

■ Features

- Diameter Ø58mm flange type
- Applicable to various mounting environments
- Various output code: BCD, Binary, Gray code (Customizable)
- Various and high resolution (720, 1024-divisions)



■ Applications

- Precision machine tool, Fabric machinery, Robot, Parking system

⚠ Please read "Caution for your safety" in operation manual before using.



■ Ordering Information

EP58SC

10

1024

1

R

P

24

Series	Shaft diameter		Resolution/ 1revolution	Output code	Rotating direction	Control output	Power supply
Diameter Ø58mm	External	10 Ø10mm	Refer to resolution	1: BCD Code 2: Binary Code 3: Gray Code	F: Output value increases at CW direction R: Output value increases at CCW direction ※Shaft based	P:PNP open collector output N:NPN open collector output	5 : 5VDC ±5% 24: 12-24VDC ±5%
SC: Shaft clamping	6	Ø6mm					
SS: Shaft synchro	8	Ø8mm					
HB: Hollow built-in	Inner						

※Gray code is customizable.

■ Specifications

Type	Diameter Ø58mm absolute rotary encoder									
Resolution ^{*1}	720, 360, 180, 90, 45-division					1024, 512, 256, 128, 64-division				
Electrical specification	Output code	BCD Code			Binary Code			Gray Code		
	Output phase/ Output angle	720-division	TS:Signal Pulse (11bit) TS:0.5°±25'	TS:Signal Pulse (10bit) TS:0.5°±25'	TS:Signal Pulse (10bit) TS:1°±25'	1024-division	TS:Signal Pulse (13bit) TS:0.3515°±15'	TS:Signal Pulse (10bit) TS:0.3515°±15'	TS:Signal Pulse (10bit) TS:0.703°±15'	
		360-division	TS:Signal Pulse (10bit) TS:1°±25'	TS:Signal Pulse (9bit) TS:1°±25'	TS:Signal Pulse (9bit) TS:2°±25'	512-division	TS:Signal Pulse (11bit) TS:0.703°±15'	TS:Signal Pulse (9bit) TS:0.703°±15'	TS:Signal Pulse (9bit) TS:1.406°±15'	
		180-division	TS:Signal Pulse (9bit) TS:2°±25'	TS:Signal Pulse (8bit) TS:2°±25'	TS:Signal Pulse (8bit) TS:4°±25'	256-division	TS:Signal Pulse (10bit) TS:1.406°±15'	TS:Signal Pulse (8bit) TS:1.406°±15'	TS:Signal Pulse (8bit) TS:2.8125°±15'	
		90-division	TS:Signal Pulse (8bit) TS:4°±25'	TS:Signal Pulse (7bit) TS:4°±25'	TS:Signal Pulse (7bit) TS:8°±25'	128-division	TS:Signal Pulse (9bit) TS:2.8125°±15'	TS:Signal Pulse (7bit) TS:2.8125°±15'	TS:Signal Pulse (7bit) TS:5.625°±15'	
		45-division	TS:Signal Pulse (7bit) TS:8°±25'	TS:Signal Pulse (6bit) TS:8°±25'	TS:Signal Pulse (6bit) TS:16°±25'	64-division	TS:Signal Pulse (7bit) TS:5.625°±15'	TS:Signal Pulse (6bit) TS:5.625°±15'	TS:Signal Pulse (6bit) TS:11.25°±15'	
	Control output	Output voltage: Min. (Power supply-1.5VDC), Load current: Max. 32mA								
		Load current: Max. 32mA, Residual voltage: Max. 1VDC								
	Response time (Rise/Fall)	Ton=800nsec, Toff=Max. 800nsec (Cable: 2m, I sink = 32mA)								
	Max. Response frequency	35kHz								
Power supply	• 5VDC ±5% (Ripple P-P: Max. 5%) • 12-24VDC ±5% (Ripple P-P: Max. 5%)									
Current consumption	Max. 100mA (disconnection of the load)									
Insulation resistance	Min. 100MΩ (at 500VDC megger between all terminals and case)									
Dielectric strength	750VAC 50/60Hz for 1 minute (Between all terminals and case)									
Connection	Cable type (Cable gland)									
Mechanical specification	Starting torque	• SC/SS type: Max. 40gf·cm (0.004N·m)			• HB type: Max. 90gf·cm (0.009N·m)					
	Moment of inertia	• SC/SS type: Max. 15g·cm ² (1.5×10 ⁻⁶ kg·m ²)			• HB type: Max. 20g·cm ² (2.0×10 ⁻⁶ kg·m ²)					
	Shaft loading	• SC/SS type: Radial: 10kg·f, Thrust: 2.5kg·f			• HB type: Radial: 2kg·f, Thrust: 1kg·f					
Max. allowable revolution ^{*2}	3000rpm									
Vibration	1.5mm amplitude at frequency of 10 to 55Hz (for 1 min.) in each X, Y, Z direction for 2 hours									
Shock	Approx. Max. 50G									
Environment	Ambient temperature	-10 to 70°C, storage: -25 to 85°C								
	Ambient humidity	35 to 85%RH, storage: 35 to 90%RH								
Protection structure	IP50 (IEC standard)									
Cable	Ø7mm, 15-wire, Length: 2m, Shield cable (AWG28, Core diameter: 0.08mm, Number of cores: 40, Insulator out diameter: Ø0.8mm)									
Accessories	Ø10mm (SC type)/Ø6mm (SS type) coupling, Fixing bracket									
Approval	CE									
Unit weight	• Clamping: Approx. 435g • Synchro: Approx. 415g • Built-in: Approx. 410g									

※1: Not indicated resolutions are customizable.

※Environment resistance is rated at no freezing or condensation.

※2: Make sure that. Max response revolution should be lower than or equal to max. allowable revolution when selecting the resolution.

$$[\text{Max. response revolution (rpm)}] = \frac{\text{Max. response frequency}}{\text{Resolution}} \times 60 \text{ sec}$$

(A) Photoelectric Sensors

(B) Fiber Optic Sensors

(C) Door/Area Sensors

(D) Proximity Sensors

(E) Pressure Sensors

(F) Rotary Encoders

(G) Connectors/Sockets

(H) Temperature Controllers

(I) SSRs / Power Controllers

(J) Counters

(K) Timers

(L) Panel Meters

(M) Tacho / Speed / Pulse Meters

(N) Display Units

(O) Sensor Controllers

(P) Switching Mode Power Supplies

(Q) Stepper Motors & Drivers & Controllers

(R) Graphic/Logic Panels

(S) Field Network Devices

(T) Software

EP58 Series

Output Waveform

• 360-division (BCD code output)

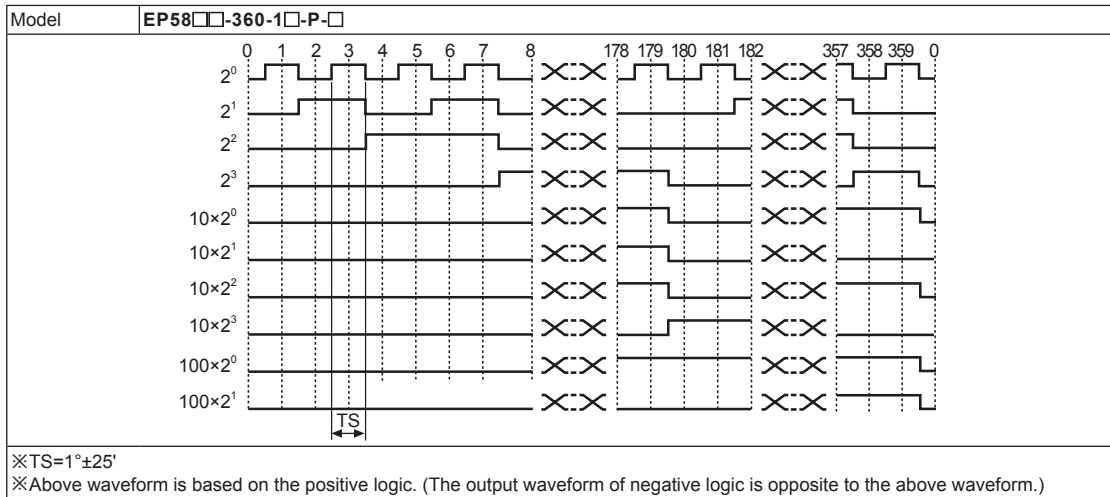

• 360-division (Binary code output)

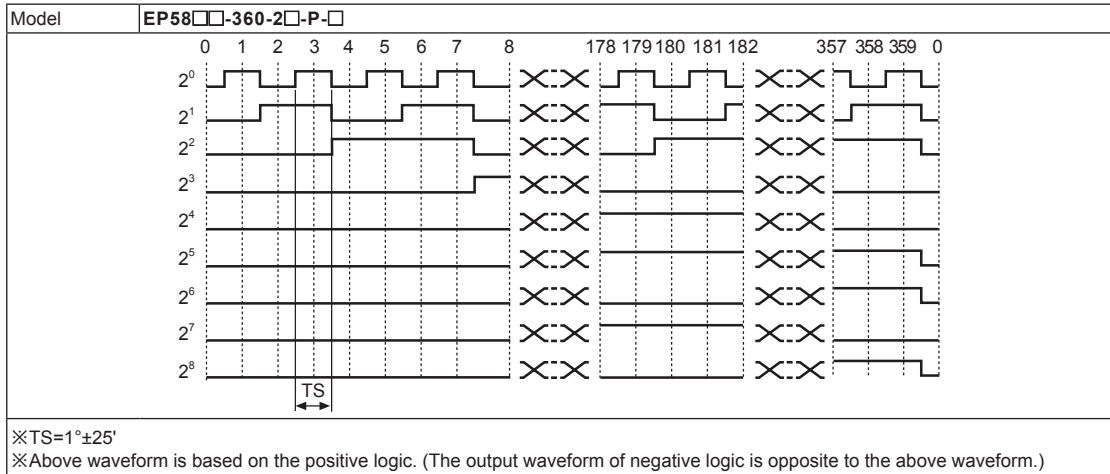

• 1024-division (BCD code output)

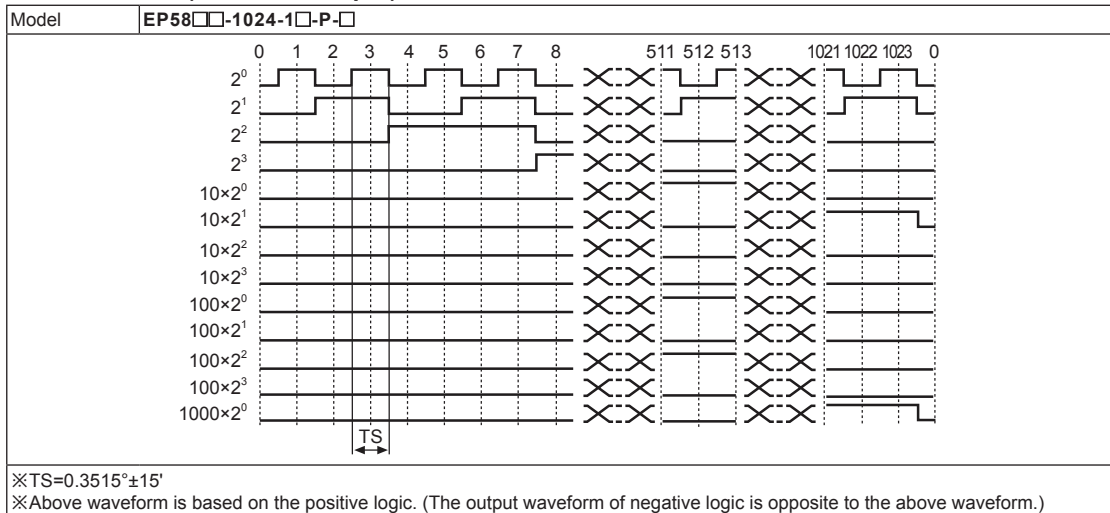

Ø58mm Shaft/Hollow Built-In Absolute Type

Output Waveform

• 1024-division (Binary code output)

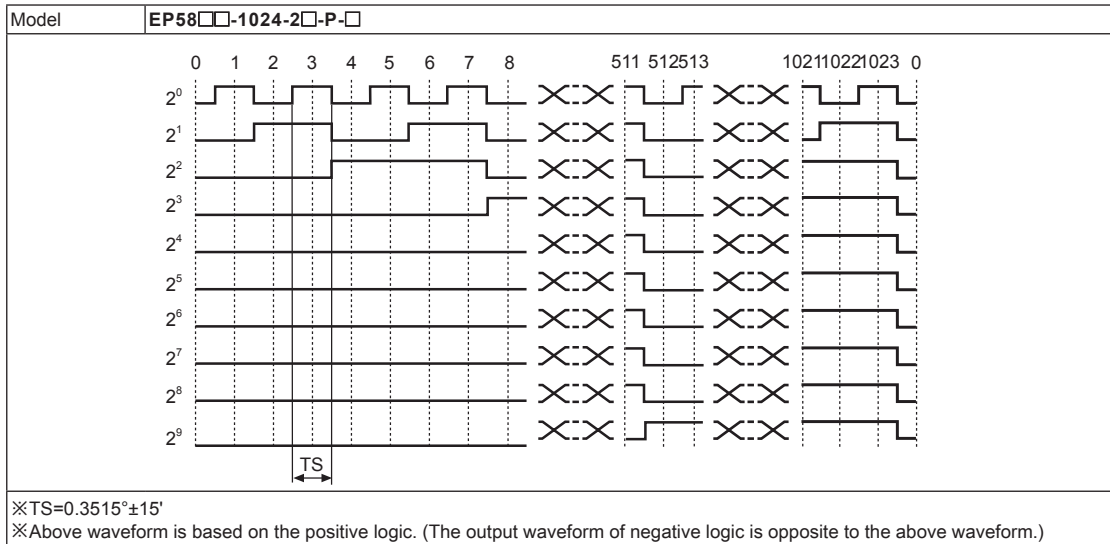

Control Output Diagram

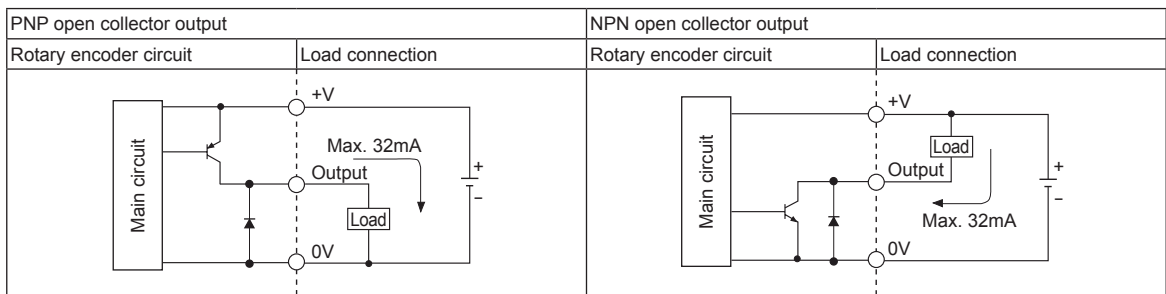

※In case of overload or short on output terminal, it may cause output circuit break.

Connections

• BCD Code

Color	Resolution (Division)	45-division	48-division	64-division	90-division	128-division	180-division	256-division	360-division	512-division	720-division	1024-division
Power		+V										
		Black GND (0V)										
Output wire	Brown	2 ⁰										
	Red	2 ¹										
	Orange	2 ²										
	Yellow	2 ³										
	Blue	(2 ³ ×10)										
	Purple	(2 ¹ ×10)										
	Gray	(2 ² ×10)										
	White/Brown	N-C	2 ³ ×10									
	White/Red	N-C	2 ⁰ ×100									
	White/Orange	N-C	2 ¹ ×100									
	White/Yellow	N-C	2 ² ×100									
	White/Blue	N-C	2 ³ ×100									
White/Purple	N-C	2 ⁰ ×1000										
Shield wire	F.G.											

• Binary Code / Gray Code

Color	Resolution (Division)	45-division	48-division	64-division	90-division	128-division	180-division	256-division	360-division	512-division	720-division	1024-division	
Power		+V											
		Black GND (0V)											
Output wire	Brown	2 ⁰											
	Red	2 ¹											
	Orange	2 ²											
	Yellow	2 ³											
	Blue	2 ⁴											
	Purple	2 ⁵											
	Gray	N-C	2 ⁶										
	White/Brown	N-C	2 ⁷										
	White/Red	N-C	2 ⁸										
	White/Orange	N-C	2 ⁹										
	White/Yellow	N-C											
	White/Blue	N-C											
White/Purple	N-C												
Shield wire	F.G.												

※Unused wires must be insulated.

※Encoder metal case and shield wire must be grounded (F.G.).

※N-C: Not connected.

※Output cable must not be short-circuited, because Driver IC is used in output circuit.

(A) Photoelectric Sensors

(B) Fiber Optic Sensors

(C) Door/Area Sensors

(D) Proximity Sensors

(E) Pressure Sensors

(F) Rotary Encoders

(G) Connectors/ Sockets

(H) Temperature Controllers

(I) SSRs / Power Controllers

(J) Counters

(K) Timers

(L) Panel Meters

(M) Tacho / Speed / Pulse Meters

(N) Display Units

(O) Sensor Controllers

(P) Switching Mode Power Supplies

(Q) Stepper Motors & Drivers & Controllers

(R) Graphic/ Logic Panels

(S) Field Network Devices

(T) Software

EP58 Series

■ Dimensions

(unit: mm)

◎ Shaft clamping type

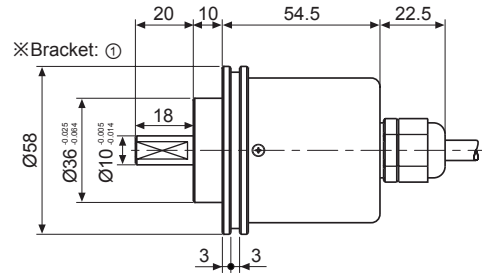
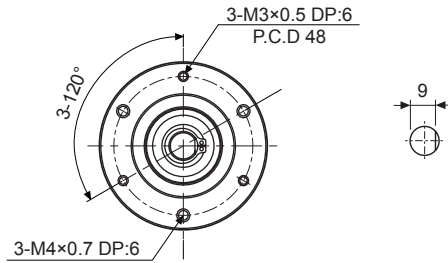

◎ Shaft synchro type

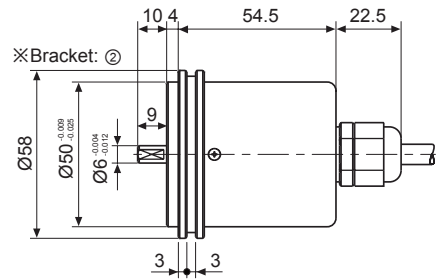
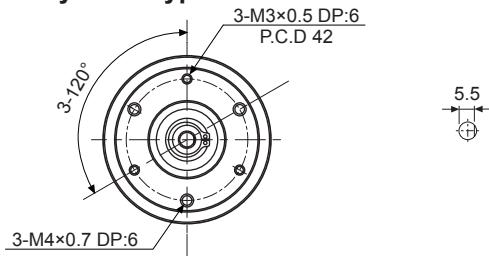

◎ Hollow built-in type

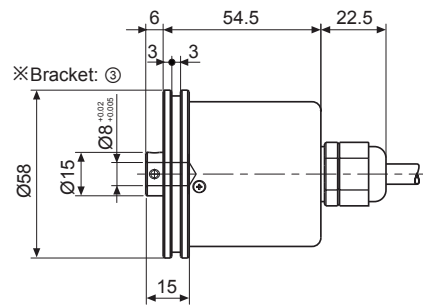
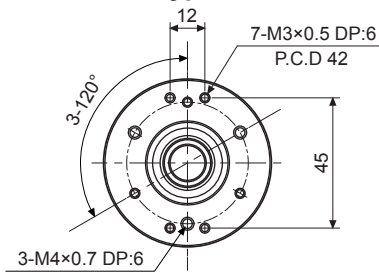

● Bracket

※SC type: ①

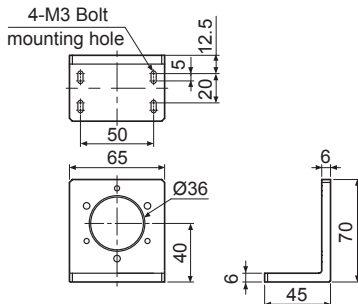

※SS type: ②

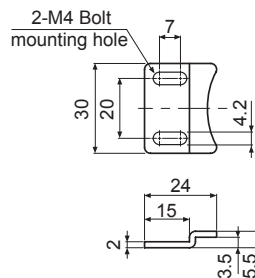

※HB/H type: ③

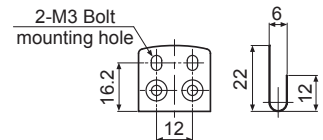

● Ø10 Coupling (EP58SC10 Series)

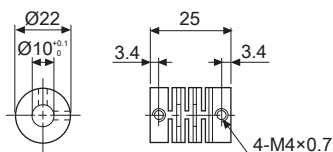

● Ø6 Coupling (EP58SS6 Series)

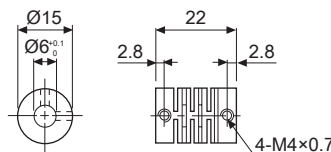

- Parallel misalignment: Max. 0.25mm
- Angular misalignment: Max. 5°
- End-play: Max. 0.2mm
- ※ For parallel misalignment, angular misalignment, End-play terms, refer to page F-71.
- ※ For flexible coupling (ERB Series) information, refer to page F-64.