

## ■ What Is GP/LP?

### ◎ GP (Graphic Panel)

GP (Graphic Panel) is graphic interface device for monitoring variables of a controller such as PLC, and is one kind of HMI(Human-Machine Interface) or MMI(Man-Machine Interface) device. By connecting GP and controller, you can visually monitor the variables of the controller and set the values. The variables can be displayed in various way. For example, temperature, which is variable to be monitored, can be displayed in number using numeric display object, and in graph using real-time trend graph to check temperature changes for a period of time.



Displaying temperature in number



Displaying temperature in graph

### ◎ LP (Logic Panel)

LP (Logic Panel) is all-in-one controller device for complicated industrial site, by adding PLC (Programmable Logic Controller) and I/O functions to HMI (Human-Machine Interface). It provides effectiveness of cost saving, cable reduction, space saving, and easier accessibility by integration of HMI, PLC and I/O.



## ■ Advantages of Using GP/LP

### ● Efficient operator/controller part

You can have advantages of cost saving, space saving, improved preservation efficiency tanks to graphicalized button, switch, lamp and other controller components.

### ● Simple settings of manufacturing process

You can change settings of PLC/controller simply without dedicated PC software for PLC/controller, because GP/LP can memorize settings of manufacturing process and command PLC/controller according to the settings.

### ● Easy data management

You can print out the alarm history of PLC/controller and save data from the bar-code leader to PLC.

## ■ Basic Preparations for Using GP/LP

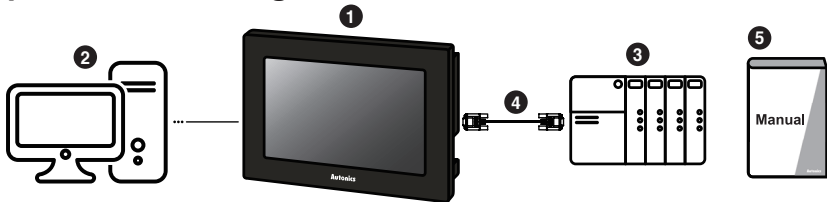

### 1 GP/LP product

### 2 PC

Required software is different by series of GP/LP to use.

For detailed information about software, refer to the following table and download from Autonics website ([www.autonics.com](http://www.autonics.com)).

GP/LP Series	Required software
GP-A	atDesigner
LP-A	atDesigner, atLogic
GP-S	GP Editor
LP-S	GP Editor, atLogic

### 3 PLC or controller such as temperature controller

### 4 Communication cable for each connected device

For detailed information about cable, refer to 'GP/LP communication cable' part in this catalogue.

### 5 Manual

Download manuals from Autonics website ([www.autonics.com](http://www.autonics.com)).

GP/LP Series	Required manual
GP-A	User manual for each series, atDesigner user manual, GP/LP user manual for communication
LP-A	User manual for each series, atDesigner user manual, atLogic user manual, atLogic programming manual, GP/LP user manual for communication
GP-S	User manual for each series, GP Editor user manual, GP/LP user manual for communication
LP-S	User manual for each series, GP Editor user manual, atLogic user manual, atLogic programming manual, GP/LP user manual for communication

SENSORS

CONTROLLERS

MOTION DEVICES

SOFTWARE

(J) Temperature Controllers

(K) SSRs

(L) Power Controllers

(M) Counters

(N) Timers

(O) Digital Panel Meters

(P) Indicators

(Q) Converters

(R) Digital Display Units

(S) Sensor Controllers

(T) Switching Mode Power Supplies

(U) Recorders

(V) HMIs

(W) Panel PC

(X) Field Network Devices

# General Features

## ■ System Organization

### ◎ STAND ALONE (LP)

LP alone can receive data from input devices and control output device without other controller.

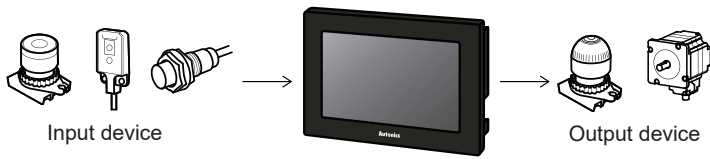

### ◎ 1:1 communication

A GP/LP can communicate with a single controller A.

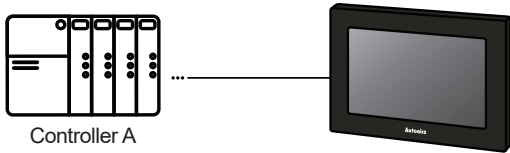

### ◎ 1:N communication of same controllers

A GP/LP can communicate with the multiple of controller As.

The GP/LP observes the connected controllers or relay data between controllers.

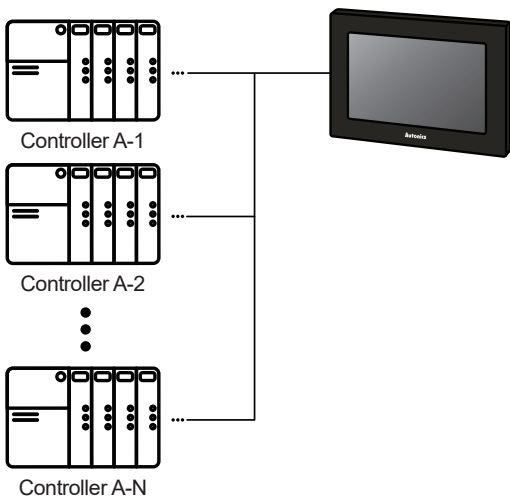

### ◎ 1:1:1 communication of different controllers

A GP/LP can communicate with a single controller A and a single controller B.

The GP/LP relays communication between the controller A and B



◎ **1:1:N communication of different controllers**

A GP/LP can communicate with a single controller A and the multiple of controller Bs.  
 The GP/LP relays communication between the controller A and B.  
 Controller has to be able to set address of each device, and the address should not be duplicated.

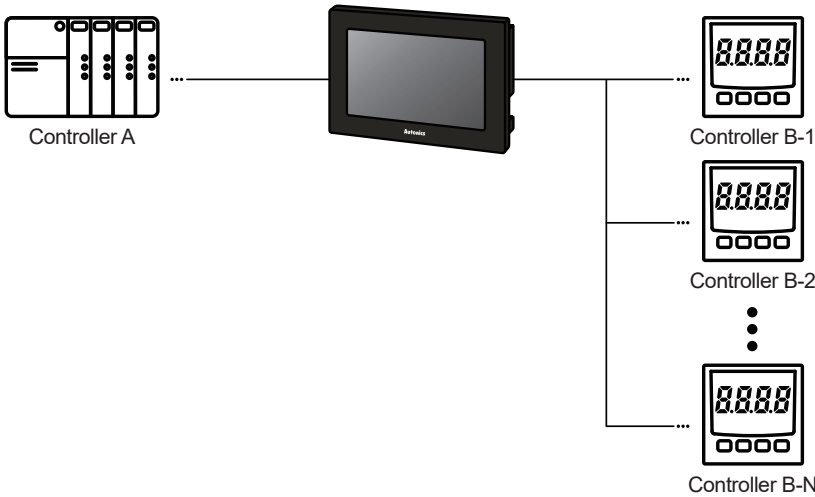

◎ **N:1:N communication of different controllers**

A GP/LP can communicate with the multiple of controller As and controller Bs.  
 The GP/LP relays communication between the controller A and B.

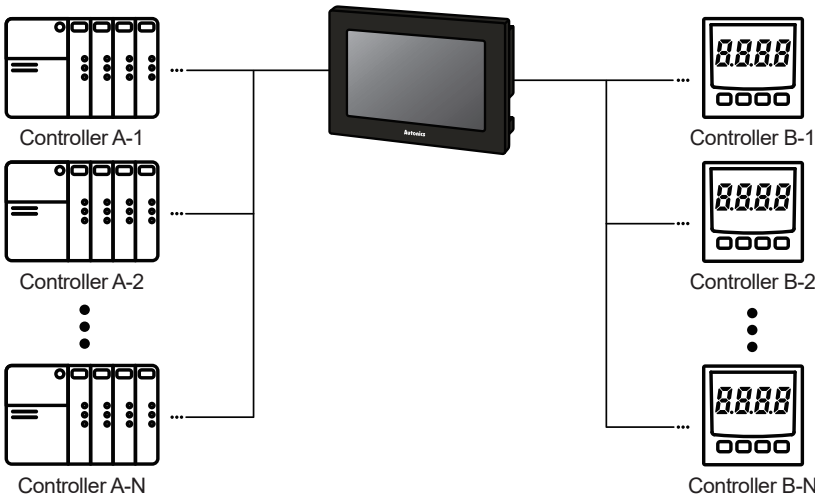

◎ **Bar-code reader, printer communication**

A GP/LP can communicate with a bar-code reader and printer.

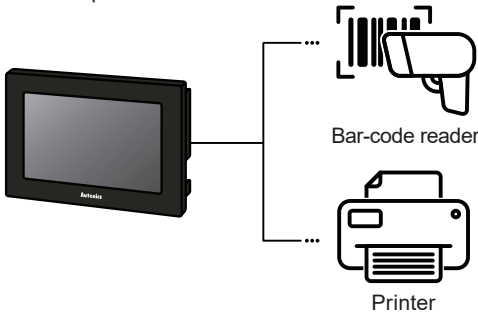

SENSORS
<b>CONTROLLERS</b>
MOTION DEVICES
SOFTWARE
(J) Temperature Controllers
(K) SSRs
(L) Power Controllers
(M) Counters
(N) Timers
(O) Digital Panel Meters
(P) Indicators
(Q) Converters
(R) Digital Display Units
(S) Sensor Controllers
(T) Switching Mode Power Supplies
(U) Recorders
<b>(V) HMIs</b>
(W) Panel PC
(X) Field Network Devices

# General Features

## ■ Software

### ○ Drawing program

#### ● at Designer

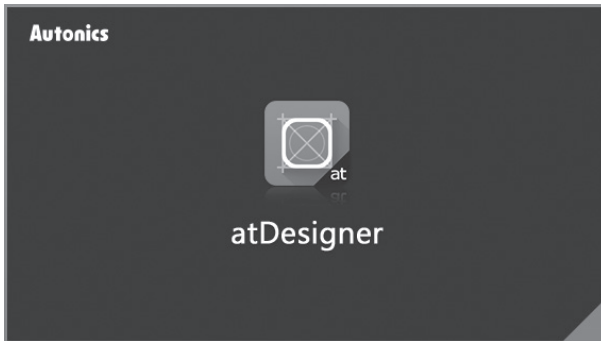

atDesigner is the user screen and project data editing program dedicated to GP/LP-A Series. With atDesigner, user can edit shape, position, property of the object and figure in the user screen and set user account, security, language, script, or etc before download to the GP/LP. It is also available to download a firmware of the GP/LP with ease.

#### System specification

Item	Minimum spec	Recommended spec
Operating system	Windows XP/Vista/7/8/10	
CPU	Pentium4 1.6GHz or above	Intel Core i5-2nd generation 2500 or above
Memory	Min. 4GB	Min. 8GB
Hard disk	Min. 4GB	Min. 8GB
Resolution	Min. 1280×1024	Min. 1920×1080

#### ● GP Editor



GP Editor is the user screen and project data editing program dedicated to GP/LP-S Series. With GP Editor, user can edit shape, position, property of the tag and figure in the user screen and set security, language, etc before download to the GP/LP. It is also available to download a firmware of the GP/LP with ease.

#### System specification

Item	Minimum spec	Recommended spec
Operating system	Windows XP/7/8/10	
CPU	Pentium4 or above	Pentium Dual Core
Memory	512MB	1GB
Hard disk	1GB (available space)	5GB (available space)
Resolution	1024×768	1280×1024

○ Logic program

● atLogic (updated SmartStudio)



atLogic is the logic programming and debugging program for the LP Series. It is easy to use for the personnel who use atLogic at first because of familiar interface similar to Microsoft Windows. Both ladder program editor and mnemonic program editor are available, so that user can select editor tool or use them simultaneously.

**System specification**

Item	Minimum spec	Recommended spec
Operating system	Windows 7/8/10	
CPU	Pentium4 or above	Pentium Dual Core
Memory	512MB	1GB
Hard disk	1GB (available space)	5GB (available space)
Resolution	1024×768	1280×1024

- SENSORS
- CONTROLLERS**
- MOTION DEVICES
- SOFTWARE

- (J) Temperature Controllers
- (K) SSRs
- (L) Power Controllers
- (M) Counters
- (N) Timers
- (O) Digital Panel Meters
- (P) Indicators
- (Q) Converters
- (R) Digital Display Units
- (S) Sensor Controllers
- (T) Switching Mode Power Supplies
- (U) Recorders
- (V) HMIs**
- (W) Panel PC
- (X) Field Network Devices

# General Features

## ■ Connectable Devices

Manufacturer	Connectable device		Communication method	GP/LP-A Series	GP/LP-S070 Series	GP/LP-S044 Series	GP-S057 Series
	Series	Model					
Autonics	TK (temperature controller)		Modbus	×	×	×	×
			Modbus(TYPE A)	○	○	○	○
	TM (temperature controller)		Modbus	×	×	×	×
			Modbus(TYPE A)	○	○	○	○
	TMH (temperature controller)		Modbus(TYPE A)	○	○	○	○
	TZ (temperature controller)		Private communication	○	○	○	○
	THD (temperature/humidity sensor)		Modbus	×	×	×	×
			Modbus(TYPE A)	○	○	○	○
	CT (counter/timer)		Modbus	×	×	×	×
			Modbus(TYPE A)	○	○	○	○
	MT (panel meter)		Private communication	○	○	○	○
			Modbus	×	×	×	×
			Modbus(TYPE A)	○	○	○	○
	MP (pulse meter)		Private communication	○	○	○	○
	DS/DA (display unit)		Modbus(TYPE A)	○	○	○	○
	ARM (field network device)		Modbus(TYPE A)	○	○	○	○
	ARD (field network device)		DeviceNet	○*	×	×	×
	LP-S044, LP-S070 (logic panel)		CPU	○	○	○	○
LP-A070, LP-A104 (logic panel)		CPU	○	○	○	○	
DPU (power controller)		Modbus	×	×	×	×	
		Modbus(TYPE A)	○	○	○	○	
KRN50 (recorder)		Modbus	×	×	×	×	
		Modbus(TYPE A)	○	○	○	○	
LS	Master-K	MK-10S1	CPU	○	○	○	○
			CPU	○	○	○	○
		MK-80S	CPU with Cnet	○	○	○	○
			Cnet unit	○	○	○	○
		MK-120S	CPU	○	○	○	○
			CPU with Cnet	○	○	○	○
			Cnet unit	○	○	○	○
		MK-200S	CPU	○	○	○	○
			CPU with Cnet	○	○	○	○
			Cnet unit	○	○	○	○
		MK-300S	CPU	○	○	○	○
			Cnet unit	○	○	○	○
	MK-1000S	CPU	○	○	○	○	
		Cnet unit	○	○	○	○	
	XGT	XGK-CPUU	CPU	○	○	○	○
			CPU	○	○	○	○
		XGK-CPUA	CPU	○	○	○	○
			CPU	○	○	○	○
		XGK-CPUS	CPU	○	○	○	○
			Cnet unit	○	○	○	○
		XGK-CPUE	CPU	○	○	○	○
			CPU	○	○	○	○
		XGI-CPUU	CPU	○	○	○	○
			CPU	○	○	○	○
		XGI-CPUH	CPU	○	○	○	○
			CPU	○	○	○	○
	XGI-CPUS	CPU	○	○	○	○	
		CPU	○	○	○	○	
	XGI-CPUE	CPU	○	○	○	○	
		CPU	○	○	○	○	
	XGR-CPUH/T	CPU	○	○	○	○	
		CPU	○	○	○	○	
		CPU	○	○	○	○	
	XGR-CPUH/F	CPU	○	○	○	○	
		CPU	○	○	○	○	
		CPU	○	○	○	○	
XGR-CPUH/S	CPU	○	○	○	○		
	CPU	○	○	○	○		
	CPU	○	○	○	○		
XGB	XEC(U)	CPU	○	○	○	○	
		CPU	○	○	○	○	
		CPU	○	○	○	○	
		CPU	○	○	○	○	
	XBM	CPU with Cnet	○	○	○	○	
		Cnet unit	○	○	○	○	
	XBC	CPU with Cnet	○	○	○	○	
Cnet unit		○	○	○	○		
Glofa	GM4	CPU	○	○	○	○	
	GM6	CPU	○	○	○	○	
	GM7U	CPU	○	○	○	○	

\*ARD Series is only available with GP/LP-A104 Series through CAN port.

# General Features

Manufacturer	Connectable device		Communication method	GP/LP-A Series	GP/LP-S070 Series	GP/LP-S044 Series	GP-S057 Series
	Series	Model					
RS Automation (Samsung) OEMMax	N70		CPU	○	○	○	○
	N70Plus		CPU	○	○	○	○
	NX7		CPU	○	○	○	○
	NX70		CPU	○	○	○	○
MITSUBISHI	FX	FX1S	CPU	○	○	○	○
		FX1N	CPU	○	○	○	○
		FX2NC	CPU	○	○	○	○
		FX2N	CPU	○	○	○	○
		FX2N-10GM	CPU	○	○	○	○
		FX2N-20GM	CPU	○	○	○	○
		FX3U	CPU	○	○	○	○
		FX3UC	CPU	○	○	○	○
	FX3G	CPU	○	○	○	○	
	MELSEC-Q	Q00J	Cnet unit	○	○	○	○
		Q00	Cnet unit	○	○	○	○
		Q01	Cnet unit	○	○	○	○
		Q02	CPU	○	○	○	○
			Cnet unit	○	○	○	○
		Q02H	CPU	○	○	○	○
			Cnet unit	○	○	○	○
		Q06H	CPU	○	○	○	○
			Cnet unit	○	○	○	○
		Q12H	CPU	○	○	○	○
			Cnet unit	○	○	○	○
		Q25H	CPU	○	○	○	○
			Cnet unit	○	○	○	○
		Q00UJ	CPU	○	○	○	○
		Q00U	CPU	○	○	○	○
		Q01U	CPU	○	○	○	○
		Q02U	CPU	○	○	○	○
		Q03UD	CPU	○	○	○	○
		Q04UDH	CPU	○	○	○	○
		Q06UDH	CPU	○	○	○	○
		Q10UDH	CPU	○	○	○	○
		Q13UDH	CPU	○	○	○	○
		Q20UDH	CPU	○	○	○	○
		Q26UDH	CPU	○	○	○	○
		Q03UDVCPU	CPU	○	×	×	×
		Q04UDVCPU	CPU	○	×	×	×
		Q06UDVCPU	CPU	○	×	×	×
		Q10UDVCPU	CPU	○	×	×	×
		Q13UDVCPU	CPU	○	×	×	×
		Q20UDVCPU	CPU	○	×	×	×
		Q26UDVCPU	CPU	○	×	×	×
QJ71E71-100		Ethernet comm. module	○	×	×	×	
QJ71E71-B5	Ethernet comm. module	○	×	×	×		
QJ71E71-B2	Ethernet comm. module	○	×	×	×		
Panasonic NAIS	FP	FP0-C16	CPU	○	○	○	○
		FP0-C32	CPU	○	○	○	○
		FP0-T32C	CPU	○	○	○	○
		FPG-C24R2	CPU	○	○	○	○
		FPG-C32T	CPU	○	○	○	○
		FPG-C32T2	CPU	○	○	○	○
		FP0R-C10	CPU	○	○	○	○
		FP0R-C14	CPU	○	○	○	○
		FP0R-C16	CPU	○	○	○	○
		FP0R-C32	CPU	○	○	○	○
		FP0R-T32	CPU	○	○	○	○
		FP0R-F32	CPU	○	○	○	○

- SENSORS
- CONTROLLERS
- MOTION DEVICES
- SOFTWARE
- (J) Temperature Controllers
- (K) SSRs
- (L) Power Controllers
- (M) Counters
- (N) Timers
- (O) Digital Panel Meters
- (P) Indicators
- (Q) Converters
- (R) Digital Display Units
- (S) Sensor Controllers
- (T) Switching Mode Power Supplies
- (U) Recorders
- (V) HMIs
- (W) Panel PC
- (X) Field Network Devices

# General Features

Manufacturer	Connectable device		Communication method	GP/LP-A Series	GP/LP-S070 Series	GP/LP-S044 Series	GP-S057 Series
	Series	Model					
OMRON	SYSMAC C	CPM1A	CPU & comm. module (Host Link)	○	○	○	○
	SYSMAC CS	CS1H	CPU	○	○	○	○
			Ethernet comm. module	○	×	×	×
		CS1G	CPU	○	○	○	○
	SYSMAC CJ	CS1D	Ethernet comm. module	○	×	×	×
			CPU	○	○	○	○
		CJ2H	CPU	○	○	○	○
	SYSMAC CJ	CJ2M	Ethernet comm. module	○	×	×	×
			CPU	○	○	○	○
		CJ1G	CPU	○	○	○	○
			Ethernet comm. module	○	×	×	×
		CJ1H	CPU	○	○	○	○
			Ethernet comm. module	○	×	×	×
	SYSMAC CP	CJ1M	CPU	○	○	○	○
			Ethernet comm. module	○	×	×	×
		CP1E	CPU	○	○	○	○
	SYSMAC CP	CP1H	CPU	○	○	○	○
Ethernet comm. module			○	×	×	×	
CP1L		CPU	○	○	○	○	
E5AN (temperature controller)		Modbus	○	○	○	○	
E5AR (temperature controller)		Modbus	○	○	○	○	
E5CN (temperature controller)		Modbus	○	○	○	○	
E5EN (temperature controller)		Modbus	○	○	○	○	
E5ER (temperature controller)		Modbus	○	○	○	○	
SIEMENS	SIMATIC S7-200	CPU221	CPU	○	○	○	○
		CPU222	CPU	○	○	○	○
		CPU224	CPU	○	○	○	○
		CPU224XP	CPU	○	○	○	○
		CPU224XPsi	CPU	○	○	○	○
	SIMATIC S7-300	CPU226	CPU	○	○	○	○
			CPU312	CPU	○	○	○
		CPU312C	CPU	○	○	○	○
			CPU313C	CPU	○	○	○
		CPU313C-2	CPU	○	○	○	○
			CPU314	CPU	○	○	○
		CPU314C-2	CPU	○	○	○	○
			CPU315-2	CPU	○	○	○
	CPU317-2	CPU	○	○	○	○	
		CPU319-3	CPU	○	○	○	○
	SIMATIC S7-1200	CPU1211C	Comm. module CM1241RS422/485	○	○	○	○
			CPU1212C	Comm. module CM1241RS422/485	○	○	○
CPU1214C		Comm. module CM1241RS422/485	○	○	○	○	
		CPU1215C	Comm. module CM1241RS422/485	○	○	○	○
CPU1217C		Comm. module CM1241RS422/485	○	○	○	○	
Rockwell Automation Allen-Bradley	MicroLogix	MicroLogix 1000	CPU	○	○	○	○
		MicroLogix 1200	CPU	○	○	○	○
		MicroLogix 1500	CPU	○	○	○	○



# General Features

Manufacturer	Connectable device		Communication method	GP/LP-A Series	GP/LP-S070 Series	GP/LP-S044 Series	GP-S057 Series
	Series	Model					
CIMON	BP	CM2-BP16M	CPU	<input type="radio"/>	<input type="radio"/>	<input type="radio"/>	<input type="radio"/>
		CM2-BP32M	CPU	<input type="radio"/>	<input type="radio"/>	<input type="radio"/>	<input type="radio"/>
	CP	CM1-CP3A	CPU	<input type="radio"/>	<input type="radio"/>	<input type="radio"/>	<input type="radio"/>
			Comm. module CM1-SC02A, CM1-SC01A, CM1-SC01B	<input type="radio"/>	<input type="radio"/>	<input type="radio"/>	<input type="radio"/>
		CM1-CP3B	CPU	<input type="radio"/>	<input type="radio"/>	<input type="radio"/>	<input type="radio"/>
			Comm. module CM1-SC02A, CM1-SC01A, CM1-SC01B	<input type="radio"/>	<input type="radio"/>	<input type="radio"/>	<input type="radio"/>
		CM1-CP3P	CPU	<input type="radio"/>	<input type="radio"/>	<input type="radio"/>	<input type="radio"/>
			Comm. module CM1-SC02A, CM1-SC01A, CM1-SC01B	<input type="radio"/>	<input type="radio"/>	<input type="radio"/>	<input type="radio"/>
		CM1-CP4A	CPU	<input type="radio"/>	<input type="radio"/>	<input type="radio"/>	<input type="radio"/>
			Comm. module CM1-SC02A, CM1-SC01A, CM1-SC01B	<input type="radio"/>	<input type="radio"/>	<input type="radio"/>	<input type="radio"/>
		CM1-CP4B	CPU	<input type="radio"/>	<input type="radio"/>	<input type="radio"/>	<input type="radio"/>
			Comm. module CM1-SC02A, CM1-SC01A, CM1-SC01B	<input type="radio"/>	<input type="radio"/>	<input type="radio"/>	<input type="radio"/>
		CM1-CP4C	CPU	<input type="radio"/>	<input type="radio"/>	<input type="radio"/>	<input type="radio"/>
			Comm. module CM1-SC02A, CM1-SC01A, CM1-SC01B	<input type="radio"/>	<input type="radio"/>	<input type="radio"/>	<input type="radio"/>
	CM1-CP4D	CPU	<input type="radio"/>	<input type="radio"/>	<input type="radio"/>	<input type="radio"/>	
		Comm. module CM1-SC02A, CM1-SC01A, CM1-SC01B	<input type="radio"/>	<input type="radio"/>	<input type="radio"/>	<input type="radio"/>	
	XP	CM1-XP1A	CPU	<input type="radio"/>	<input type="radio"/>	<input type="radio"/>	<input type="radio"/>
			Comm. module CM1-SC02A, CM1-SC01A, CM1-SC01B	<input type="radio"/>	<input type="radio"/>	<input type="radio"/>	<input type="radio"/>
		CM1-XP1R	CPU	<input type="radio"/>	<input type="radio"/>	<input type="radio"/>	<input type="radio"/>
			Comm. module CM1-SC02A, CM1-SC01A, CM1-SC01B	<input type="radio"/>	<input type="radio"/>	<input type="radio"/>	<input type="radio"/>
CM1-XP2A	Comm. module CM1-SC02A, CM1-SC01A, CM1-SC01B	<input type="radio"/>	<input type="radio"/>	<input type="radio"/>	<input type="radio"/>		
	Comm. module CM1-SC02A, CM1-SC01A, CM1-SC01B	<input type="radio"/>	<input type="radio"/>	<input type="radio"/>	<input type="radio"/>		
DELTA	DTB (temperature controller)	Modbus	<input checked="" type="checkbox"/>	<input checked="" type="checkbox"/>	<input checked="" type="checkbox"/>	<input checked="" type="checkbox"/>	
		Modbus(TYPE A)	<input type="radio"/>	<input type="radio"/>	<input type="radio"/>	<input type="radio"/>	
DANFOSS	FC200	Modbus	<input checked="" type="checkbox"/>	<input checked="" type="checkbox"/>	<input checked="" type="checkbox"/>	<input checked="" type="checkbox"/>	
		Modbus(TYPE A)	<input type="radio"/>	<input type="radio"/>	<input type="radio"/>	<input type="radio"/>	
MODBUS MASTER	-	Modbus(Master)	<input type="radio"/>	<input type="radio"/>	<input type="radio"/>	<input type="radio"/>	

※The list of connectable device is continue to updated according to atDesigner and GP Editor upgrade.

Before use of GP/LP, check the version of atDesigner and GP Editor and download newest version of the software via Autonics website ([www.autonics.com](http://www.autonics.com)).

SENSORS

CONTROLLERS

MOTION DEVICES

SOFTWARE

(J)  
Temperature  
Controllers

(K)  
SSRs

(L)  
Power  
Controllers

(M)  
Counters

(N)  
Timers

(O)  
Digital  
Panel Meters

(P)  
Indicators

(Q)  
Converters

(R)  
Digital  
Display Units

(S)  
Sensor  
Controllers

(T)  
Switching  
Mode Power  
Supplies

(U)  
Recorders

(V)  
HMI's

(W)  
Panel PC

(X)  
Field Network  
Devices