

Processor Controller

KPN Series

User Manual



KPN Series

Preface

Thank you for purchasing Autonics product.





Please familiarize yourself with the information contained in the **Safety Precautions** section before using this product.

This user manual contains information about the product and its proper use, and should be kept in a place where it is easy to access.

User Manual Guide

- Please familiarize yourself with the information in this manual before using the product.
- This manual provides detailed information on the product's features. It does not offer any guarantee concerning matters beyond the scope of this manual.
- This manual may not be edited or reproduced in either part or whole without permission.
- A user manual is not provided as part of the product package.
Visit our web site (www.autonics.com) to download a copy.
- The manual's content may vary depending on changes to the product's software and other unforeseen developments within Autonics, and is subject to change without prior notice.
Upgrade notice is provided through out homepage.
- We contrived to describe this manual more easily and correctly. However, if there are any corrections or questions, please notify us these on our homepage.

User Manual Symbols

Symbol	Description
 Note	Supplementary information for a particular feature.
 Warning	Failure to follow instructions can result in serious injury or death.
 Caution	Failure to follow instructions can lead to a minor injury or product damage.
 Ex.	An example of the concerned feature's use.
※1	Annotation mark.

Safety Precautions

- Following these safety precautions will ensure the safe and proper use of the product and help prevent accidents and minimize hazards.
- Safety precautions are categorized as Warnings and Cautions, as defined below:

 Warning	Warning	Cases that may cause serious injury or fatal accident if instructions are not followed.
--	----------------	---

 Caution	Caution	Cases that may cause minor injury or product damage if instructions are not followed.
--	----------------	---

Warning

- In case of using this unit with machinery (Ex: nuclear power control, medical equipment, ship, vehicle, train, airplane, combustion apparatus, safety device, crime/disaster prevention equipment, etc) which may cause damages to human life or property, it is required to install fail-safe device.
It may cause a fire, human injury or property loss.
- Install the unit on the panel.
It may cause electric shock.
- Do not connect, inspect, or repair when power is ON.
It may cause electric shock.
- Wire properly after checking the input specifications and terminal number.
It may cause a fire.
- Do not disassemble the case. Please contact us if it is required.
It may cause electric shock or a fire.

Caution

- This unit shall not be used outdoors.
It might shorten the life cycle of the product or cause electric shock.
- When wiring relay output terminal, AWG 20(0.5mm²) should be used.
It may cause a malfunction or fire due to contact failure.
- Please observe the rated specifications.
It might shorten the life cycle of the product and cause a fire.
- Do not use beyond of the rated switching capacity of relay contact.
It may cause insulation failure, contact melt, contact failure, relay broken or fire, etc.
- In cleaning unit, do not use water or an oil-based detergent and use dry towels.
It may cause electric shock or a fire.
- Do not use this unit in place where there are flammable or explosive gas, humidity, direct ray of the light, radiant heat, vibration and impact etc.
It may cause a fire or an explosion.
- Do not inflow dust or wire dregs into the unit.
It may cause a fire or a malfunction.
- Please wire properly after checking the terminal polarity when connecting temperature sensor.
It may cause a fire or a malfunction.

Specifications and dimensions in this user manual are subject to change without notice.

Table of Contents

Preface	iii
User Manual Guide	iv
User Manual Symbols	v
Safety Precautions	vi
Table of Contents	vii
1 Product Introduction.....	11
1.1 Features	11
1.2 Components and accessories	12
1.3 Ordering information	16
1.4 Part descriptions	17
2 Specifications.....	19
2.1 Ratings	19
3 Dimensions.....	21
4 Connections	23
4.1 Wiring precautions	25
4.1.1 Sensor connection	25
4.1.2 Communication line wiring	25
5 Preparation and Startup	27
5.1 Powering ON and initial display.....	27
5.2 Basic controls.....	27
5.2.1 Parameter setting sequence	27
5.2.2 SV setting	28
5.2.3 MV Monitoring and Manual Control Setting	29
5.3 Parameter Reference Chart	30
5.4 Parameter Setting Groups	33
5.4.1 Parameter 1 Setting Group [PAR 1]	33
5.4.2 Parameter 2 Setting Group [PAR 2]	34
5.4.3 Parameter 3 Setting Group [PAR 3]	36
5.4.4 Parameter 4 Setting Group [PAR 4]	38
5.4.5 Parameter 5 Setting Group [PAR 5]	40
6 Parameter Settings and Functions.....	43
6.1 Input	43
6.1.1 Input types and temperature ranges	43
6.1.2 Input type [PAR 3 In-t].....	44
6.1.3 Sensor temperature unit [PAR 3 Unit].....	44
6.1.4 Analog input/scale value	45
6.1.5 Input correction [PAR 3 In-b]	47
6.1.6 Input digital filter [PAR 3 nAUF].....	47
6.1.7 SV high/low limit value [PAR 3 H-SV/L-SV].....	48
6.2 Control output	49

6.2.1	Control output mode [PAR3 o-Ft].....	49
6.2.2	MV high/low-limit [PAR2 H-nu / L-nu].....	54
6.2.3	RAMP [PAR2 rAnu/rAnd/rUnt].....	55
6.2.4	Auto/ Manual control	56
6.2.5	Output type.....	60
6.3	Temperature control.....	61
6.3.1	Temperature control type [PAR3 [-nd].....	61
6.3.2	ON/OFF control [PAR3 [-nd onof].....	61
6.3.3	PID control [PAR3 [-nd Pid].....	63
6.3.4	Auto-tuning	66
6.4	Alarm.....	68
6.4.1	Alarm operation [PAR4 AL-1/AL-2/AL-3].....	68
6.4.2	Alarm option [PAR4 AL1t/AL2t/AL3t].....	69
6.4.3	Alarm output set value [PAR4 AL1L/AL1H/AL2L/AL2H/AL3L/AL3H]..	70
6.4.4	Alarm output hysteresis [PAR4 A1H/A2H/A3H].....	71
6.4.5	Alarm output contact type [PAR4 A1n/A2n/A3n].....	71
6.4.6	Alarm output dealy time [PAR4 A1on/A1of/A2on/A2of/A3on/A3of]72	
6.4.7	Loop break alarm (LBA) [PAR4 AL-1/AL-2/AL-3 LbA].....	73
6.4.8	Sensor break alarm [PAR4 AL-1/AL-2/AL-3 SbA].....	75
6.4.9	Heater break alarm [PAR4 AL-1/AL-2/AL-3 HbA].....	75
6.4.10	Alarm output clear [PAR5 dl-t ALrE].....	77
6.4.11	Alarm output operation	78
6.5	Analog transmission	81
6.5.1	Analog transmission output value [PAR4 Ao-n].....	81
6.5.2	Transmission output high/low-limit value [PAR4 FS-L/FS-H].....	81
6.6	Communication.....	83
6.6.1	Communication address [PAR4 Adr5].....	83
6.6.2	Communication speed [PAR4 bP5].....	83
6.6.3	Communication parity bit [PAR4 PrtY].....	84
6.6.4	Communication stop bit [PAR4 StP].....	84
6.6.5	Communication response waiting time [PAR4 r5yt].....	84
6.6.6	Enable/Disable communication write [PAR4 [onY].....	85
6.6.7	USB to Serial connection	85
6.7	Additional Features.....	86
6.7.1	Monitoring.....	86
6.7.2	RUN/STOP [PAR1 r-5].....	87
6.7.3	Multi SV	88
6.7.4	Digital input.....	90
6.7.5	Error.....	92
6.7.6	User level [PAR5 USEr].....	93
6.7.7	Lock.....	94
6.7.8	Parameter initialization [ini t].....	94
6.7.9	Password [PAR5 Pwd].....	95
7	Parameter Description by Setting group.....	97
7.1	SV Setting group [5v].....	97
7.2	MV monitoring/Manual control setting group [nu].....	97
7.3	Parameter 1 setting group [PAR1].....	98
7.4	Parameter 2 Setting group [PAR2].....	99

7.5	Parameter 3 Setting group [<i>PAR3</i>].....	101
7.6	Parameter 4 Setting group [<i>PAR4</i>].....	103
7.7	Parameter 5 Setting group [<i>PAR5</i>].....	105
7.8	Password input parameter.....	106
7.9	Initialized parameters by changing the related parameters	106
8	DAQMaster	107
8.1	Overview	107
8.2	Features.....	108
8.3	KPN series special features	109
8.3.1	Parameter mask.....	109
8.3.2	User parameter group [<i>PARU</i>].....	111

1 Product Introduction

1.1 Features

KRN series – standard PID temperature controller – realizes more powerful control with super high-speed sampling cycles of 50 ms and $\pm 0.3\%$ display accuracy. It supports diverse control modes including heating/cooling simultaneous control, and automatic/manual control and communication functions. In addition, KRN series covers all necessary features for high performance temperature controllers – that is, diverse input sensor support, multi SV setting, SSRP + current output, high resolution display and compact size.

- Easy and fast setting by user parameter group and parameter mask functions
- Easy check control output MV with Bar graph
- Super high-speed sampling cycle (10 times faster compared to existing models); 50 ms sampling cycle and $\pm 0.3\%$ display accuracy
- Improved visibility with wide display and high luminance LED
- High performance control with heating/cooling control and automatic/manual control modes
- Communication function supported : RS485(Modbus RTU method)
- High performance control with heating/cooling control and automatic/manual control modes
PC parameter setting via USB and RS 485 communication: Integrated device management program (DAQMaster) supported
 - ※ Communication converter, sold separately: SCM-US (USB to Serial converter), SCM-381 (RS232C to RS485 converter), SCM-US480 (USB to RS485 converter)
- Selectable SSR output or current output
- Heater disconnection alarm (CT input) function
 - ※CT, sold separately: CSTC-E80LN, CSTC-E200LN
- Multi-SV (up to 3) setting (selectable by digital input terminal)
- Space saving mounting possible with compact design; downsized by 38% depth-based (panel rear length: 60mm)
- Multi-input/multi-range

1.2 Components and accessories

(1) Components



KPN Series

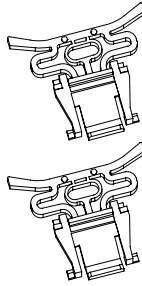

Brackets

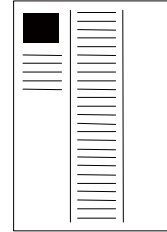

Manual



Note

Make sure all of the above components are included with your product package before using it. If components are missing or damaged, please contact Autonics or your distributor.

(2) Accessories



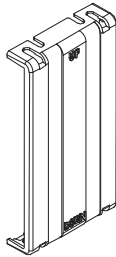

- Terminal cover
 - RHA-COVER (48×96mm)

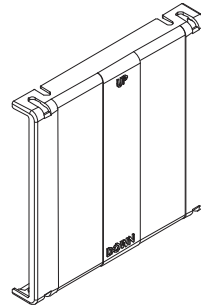

- RLA-COVER (96×96mm)



Communication converter

<p>SCM-WF48 (USB to RS485 converter)</p>	<p>SCM-US48I (USB to RS485 converter)</p>
	
<p>SCM-38I (RS232C to RS485 converter)</p>	<p>SCM-US (USB to Serial converter)</p>
	



Note

For more information 'Communication converters' sold separately, refer to the manual of each products.

Visit our website(www.autonics.com) to download the manuals.

■ **Current transformer (CT)**

CSTC-E80LN

- Max. load current: 80A(50/60Hz)
- ※ Max. load current for KPN Series is 50A.
- Current ratio: 1/1000
- Wire wounded resistance: 31 ±10%

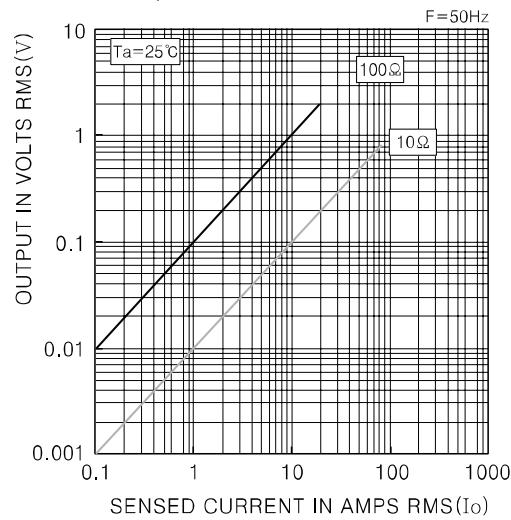
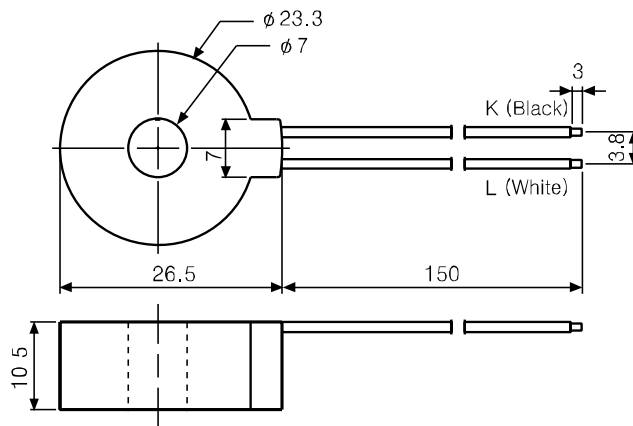

CSTC-E200LN

- Max. load current: 200A(50/60Hz)
 ※ Max. load current for KPN Series is 50A.
- Current ratio: 1/1000
- Wire wounded resistance: 20 \pm 10%

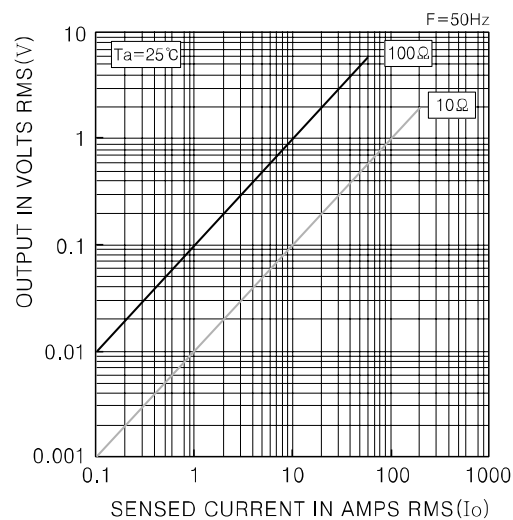
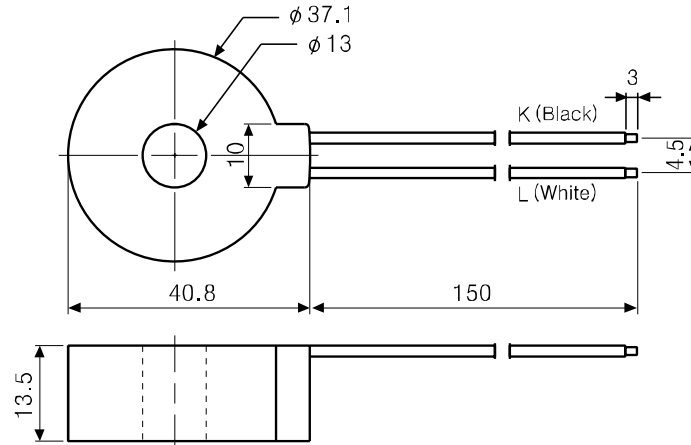
**Note**

Images of components and accessories may differ from actual products.

For more information about CT, refer to the manual of this unit.

Visit our website (www.autonics.com) to download the manuals of this unit.

**Caution**

※Do not supply primary current in case that CT output is open. High voltage will be generated in CT output.

※The current for above two CTs is 50A same but inner hole sizes are different. Please use this for your environment.

1.3 Ordering information

KPN5	5	0	0	-	0	0	0
①	②	③	④		⑤	⑥	⑦

Category		Description	
① Item	KPN5	Temperature / Process Controller	
② Size	2	DIN W96 X H48mm	
	3	DIN W48 X H96mm	
	5	DIN W96 X H96mm	
③ Number of control outputs	0	1 output type (Heating or Cooling type)	
	1	2 output type (Heating&Cooling)	
④ Control output ※1	1 output type	0 Relay, current, SSR drive voltage selection output	
	2 output type	1	OUT1: Current, SSR drive voltage selection output OUT2: Current, SSR drive voltage selection output
		3	OUT1: Current, SSR drive voltage selection output OUT2: Relay output
		7	OUT1: Relay output OUT2: Current, SSR drive voltage selection output
		9	OUT1: Relay output OUT2: Relay output
⑤ Option com. output	0	None	
	2	RS485	
⑥ Option I/O	0	None	
	3	Transmission output+Remote SV	
⑦ Power supply	0	100 - 240VAC 50/60Hz	

※1. The 1 output type is heating or cooling output type and the 2 output type is heating & cooling output type.

The 1 output type is able to use only one output among relay, current, SSR drive voltage outputs.

OUT1 of the 2 output type is fixed as heating output and OUT2 of the 2 output type is fixed as cooling output.

If you select the SSR drive voltage or current output model, you can select the appropriate control output.

1.4 Part descriptions

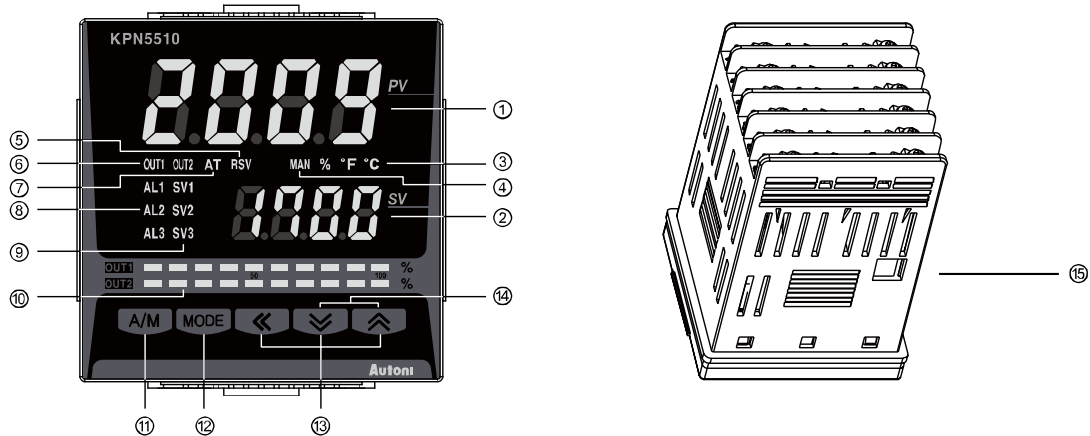

- ① Measured value (PV) display part
RUN mode: Displays currently measured value (PV).
Set mode: Displays the parameters.
 - ② Set value (SV) display part
RUN mode: Displays the set value (SV).
Set mode: Displays the set value of the parameter.
 - ③ Unit (°C/°F/%) indicator: Displays the unit set at display unit [dUnit] in parameter 3 group.
 - ④ Manual control indicator: Turns ON during manual controlling.
 - ⑤ Remote SV control indicator: Turns ON during remote SV controlling
 - ⑥ Control output (OUT1, OUT2) indicator: Turns ON when the control output is ON.
※ When using current output, in case that for manual control MV is 0.0%, the control output indicator turns OFF but the other cases it turns ON always. In case that for auto control MV is over 3.0%, it turns ON and the MV is below 2.0%, it turns OFF.
 - ⑦ Auto tuning indicator: Flashes by 1 sec. when executing auto tuning.
 - ⑧ Alarm output (AL1, AL2, AL3) indicator: Turns ON when the alarm output is ON.
 - ⑨ Multi-SV indicator: The SV 1 to 3 indicator turns ON when using multi SV function.
 - ⑩ Bar graph for control output: Displays control output MV as bar graph. The KRN5 00 as 1 output type has one bar graph (OUT1), and the KPN5 1 as 2 output type has two bar graphs (OUT1, OUT2).
 - ⑪ **A/M** key: Used when switching auto control to manual control.
 - ⑫ **MODE** key: Used when entering parameter setting group, returning to RUN mode, moving parameter, saving the set value.
 - ⑬ **←** **↓** **↑** keys: Used when entering the set value changing mode and moving or changing up/down digit.
 - ⑭ When pressing **↓** **↑** keys for 3 sec. at the same time, it operates the function (RUN/STOP, alarm clear, auto-tuning) set at digital input key [di - L] in parameter 5 group.
 - ⑮ PC loader port: It is the PC loader port for serial communication to set and monitor parameters by PC. Use this port for connection SCM-US (USB to serial convertor).
- ※ Display part is different by options.

**Note**

7-segment characters

<i>A</i>	<i>b</i>	<i>c</i>	<i>d</i>	<i>E</i>	<i>F</i>	<i>G</i>	<i>H</i>	<i>I</i>	<i>J</i>	<i>K</i>	<i>L</i>	<i>M</i>
A	B	C	D	E	F	G	H	I	J	K	L	M

<i>n</i>	<i>o</i>	<i>P</i>	<i>q</i>	<i>r</i>	<i>S</i>	<i>t</i>	<i>U</i>	<i>v</i>	<i>w</i>	<i>x</i>	<i>Y</i>	<i>Z</i>
N	O	P	Q	R	S	T	U	V	W	X	Y	Z

<i>0</i>	<i>1</i>	<i>2</i>	<i>3</i>	<i>4</i>	<i>5</i>	<i>6</i>	<i>7</i>	<i>8</i>	<i>9</i>	<i>0</i>	<i>-1</i>	<i>/</i>
0	1	2	3	4	5	6	7	8	9	0	-1	/

2 Specifications

2.1 Ratings

Series		KPN52□□	KPN53□□	KPN55□□
Power supply	100 - 240VAC, 50/60Hz			
Allowable voltage range	90 to 110% of rated voltage			
Power consumption	Max. 15VA			
Display method	7Segment: red/green, control output display bar graph: red/green			
Character size	PV(W x H)	8.5X17.0mm	7.0X14.6mm	11.0X22.0mm
	SV(W x H)	6.0X12.0mm	6.0X12.0mm	6.0X12.0mm
Input type	RTD	JPt 100Ω, DPt 100Ω, DPt 50Ω, Cu 100Ω, Cu 50Ω, Nickel 120Ω (6 types)		
	Thermocouples	K, J, E, T, L, N, U, R, S, B, C, G, PLII(13 types)		
	Analog	Voltage: 0 to 100mV, 0 to 5V, 1 to 5V, 0 to 10V(4 type) Current: 0 to 20mA, 4 to 20mA(2 types)		
Display accuracy	RTD	At room temperature (23°C±5°C): (PV ±0.3% or ±1°C, select bigger one)±1Digit*1		
	Thermocouples	Out of room temperature range: (PV ±0.5% or ±2°C, select bigger one)±1Digit		
	Analog	At room temperature (23°C±5°C): ±0.3% F.S.±1Digit Out of room temperature range: ±0.5% F.S.±1Digit		
	CT input	±5% F.S.±1Digit		
Control output	Relay	OUT1, OUT2: 250VAC 3A 1a		
	SSR	Max. 11VDC±2V 20mA		
	Current	DC4 - 20mA or DC0 - 20mA or selectable (max. load 500Ω)		
Alarm output	Relay	AL1, AL2, AL3 Relay: 250VAC 3A 1a		
Option output	Transmission	DC4 - 20mA (max. load 500Ω, output accuracy: ±0.3% F.S.±1Digit)		
	Communication	RS485 communication output (Modbus RTU method)		
Option input	CT	0.0 - 50.0A(primary heater current value measuring range) ※CT ratio is 1/1000		
	Remote SV	1-5VDC or DC4-20mA (Current input: use external resistance 250Ω)		
	Digital input	Contact input: ON-max. 2kΩ, OFF-min. 90kΩ Non-contact input: ON- Residual voltage max.1.0V, OFF-leakage current max.0.1mA		
Control type	Heating, Cooling	ON/OFF, P, PI, PD, PID control		
	Heating&Cooling			
Hysteresis	Thermocouple/RTD: 1 to 100°C/°F (0.1 to 100.0°C/°F) variable, Analog: 1 to 100 Digit			
Proportional band (P)	0.1 to 999.9°C(0.1 to 999.9%)			
Integral time (I)	0 to 9999 sec.			
Derivative time (D)	0 to 9999 sec.			
Control period (T)	0.1 to 120.0 sec. (relay output, SSR drive voltage output only)			
Manual reset value	0.0 to 100.0%			

Sampling period		50ms
Dielectric strength		2000VAC 50/60Hz for 1 min. (between input terminal and power source terminal)
Vibration		0.75mm amplitude at frequency of 5 to 55 Hz (for 1 min.) in each X, Y, Z direction for 2 hours
Relay life cycle	Mechanical	Over 10,000,000 times
	Electrical	Over 100,000 times (250VAC 3A resistance load)
Insulation resistance		Over 100M (at 500VDC megger)
Noise resistance		Square shaped noise by noise simulator (pulse width 1 μ s) \pm 2KV R-phase, S-phase
Memory retention		Approx. 10 years (when using non-volatile semiconductor memory type)
Environment	Ambient temperature	-10 to 50°C, storage: -20 to 60°C
	Ambient humidity	35 to 85% RH, storage: 35 to 85% RH
Protection		IP65(front part)
Insulation type		Double insulation or reinforced insulation (mark: <input type="checkbox"/> , dielectric strength between the measuring input part and the power part: 1kV)
Weight ^{*2}		Approx. 230g (approx. 160g) Approx. 316g (approx. 220g)

※1. At room temperature (23°C \pm 5°C)

- TC K, J, T, N, E type, below -100°C / L, U, PLII, RTD Cu50 Ω , DPt50 Ω : (PV \pm 0.3% or \pm 2°C, select the higher one) \pm 1Digit
- TC C, G and R, S type, below 200°C: (PV \pm 0.3% or \pm 3°C, select the higher one) \pm 1Digit
- TC B type, below 400°C, there is no accuracy standards.

Out of room temperature range

- RTD Cu50 Ω , DPt50 Ω : (PV \pm 0.5% or \pm 3°C, select the higher one) \pm 1Digit
- RTD R, S, B, C, G: (PV 0.5% or \pm 10°C, select the higher one) \pm 1Digit
- Other sensors: Below -100°C, within \pm 5°C

※2. The weight is with packaging and the weight in parentheses is only unit weight.

※ Environment resistance is rated at no freezing or condensation.

3 Dimensions

Unit: mm

(1) KPN52 □ □

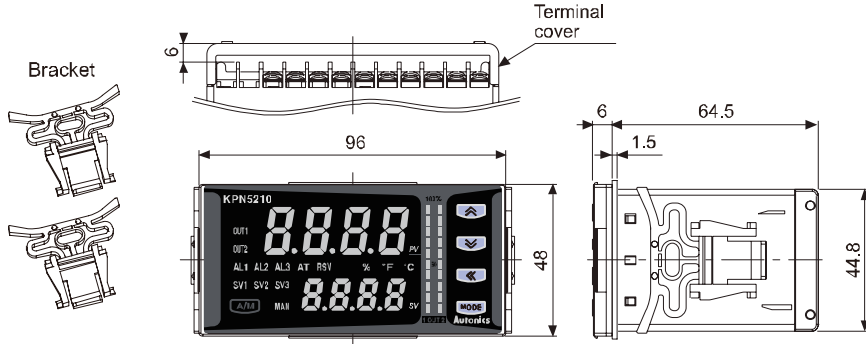

(2) KPN53 □ □

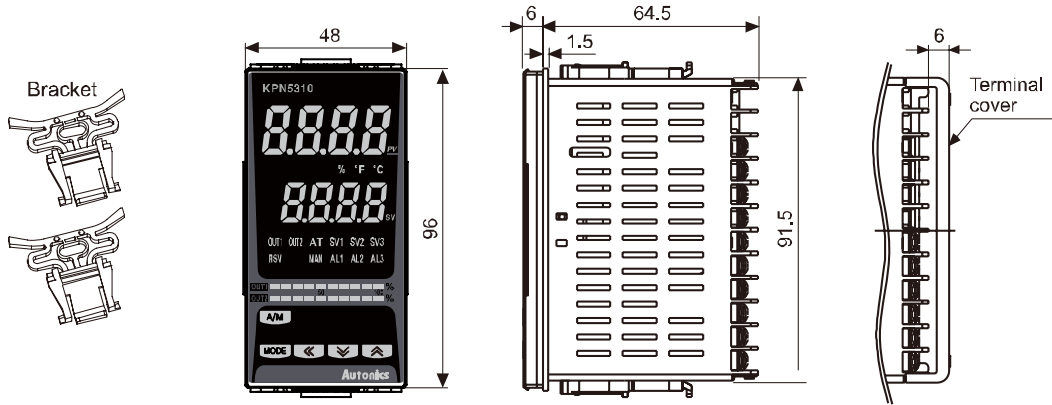

(3) KPN55 □ □

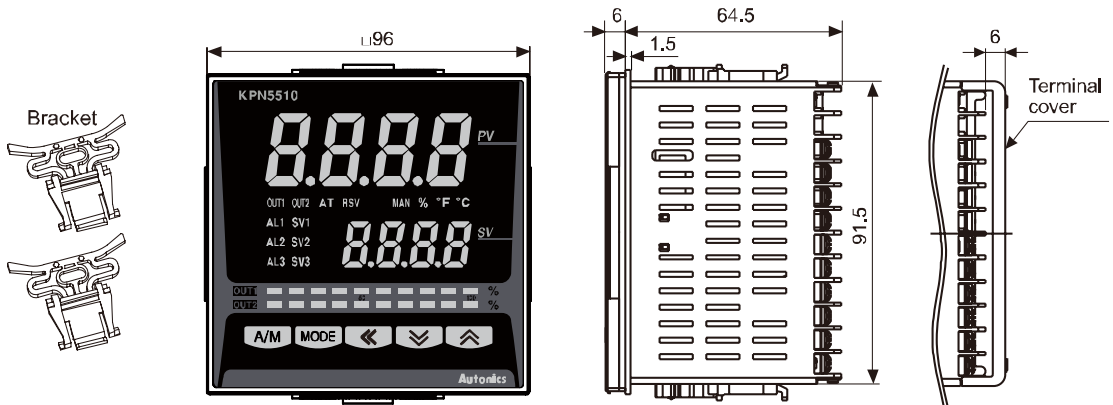

(4) Terminal cover (sold separately)

• RHA-COVER(48×96mm)

• RLA-COVER(96×96mm)

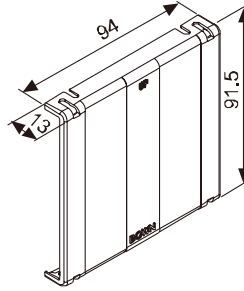
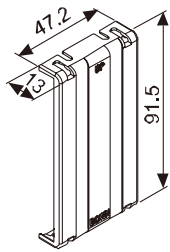

(5) Panel cut-out

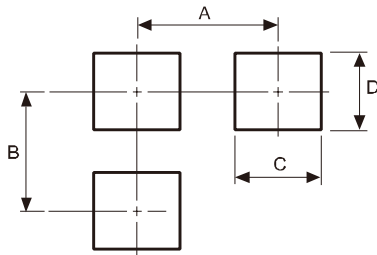

(Unit:mm)

Model	Unit	A	B	C	D
KPN52□□		Min. 115	Min. 65	92 ^{+0.8} ₀	45 ^{+0.6} ₀
KPN53□□		Min. 65	Min. 115	92 ^{+0.8} ₀	92 ^{+0.8} ₀
KPN55□□		Min. 115	Min. 115	45 ^{+0.6} ₀	92 ^{+0.8} ₀

■ Installations

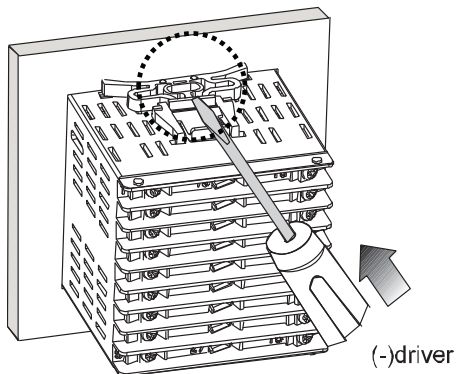

Mount this unit into a panel, fasten bracket by pushing with a flat-head driver as shown.

4 Connections

Standard model has shaded terminals only. is option specification.

(1) KPN5 00

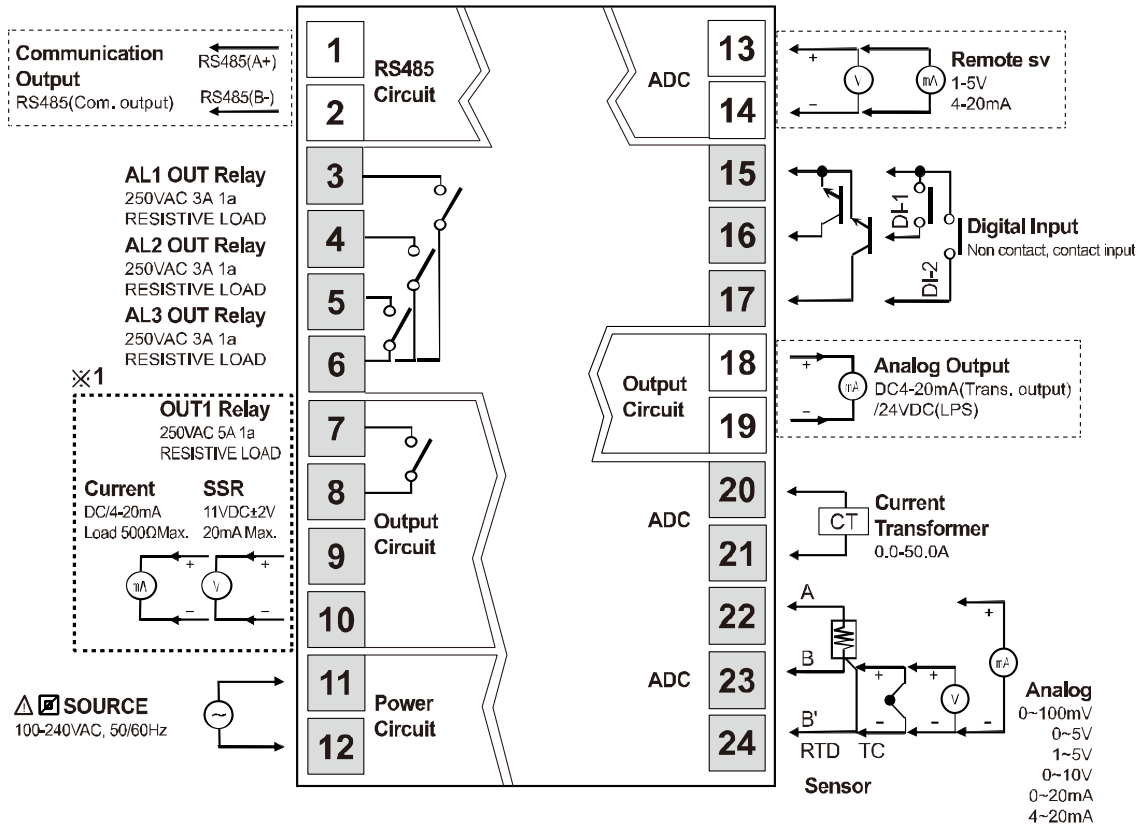

※1. Set relay output [rly], current [cur] or SSR drive voltage output [ssr] at OUT1 control output [out1] in parameter 3 group.

(2) KPN5□1□

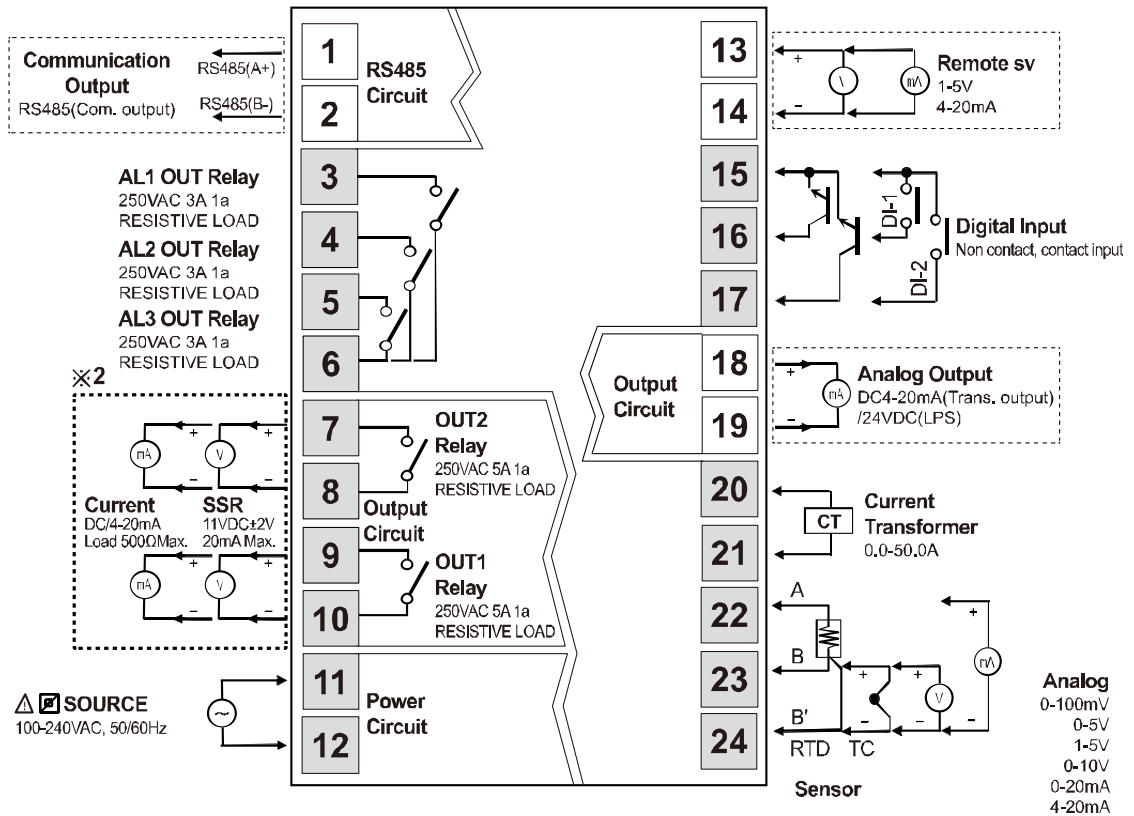

※2. OUT1, OUT2

Model	OUT1 control output	OUT2 control output
KPN5□11	Current, SSR drive voltage selection output	Current, SSR drive voltage selection output
KPN5□13	Current, SSR drive voltage selection output	Relay output
KPN5□17	Relay output	Current, SSR drive voltage selection output
KPN5□19	Relay output	Relay output

4.1 Wiring precautions

- Mixing up the input terminals with output terminals and vice versa can lead to product damage.
- Use only sensors supported by the product.
- Make sure to connect rated SSRs or loads to the output terminals.
- Make sure to connect communication cable with correct communication terminals (A, B).
- Make sure to observe correct polarity of power source terminals. (+ and -).

4.1.1 Sensor connection

(1) Compensation wire connection

For thermocouple sensors, use compensation wire of the same specification as input sensors. Using an extension wire of different specifications and/or material increases inaccuracy of temperature sensing. It is recommended to choose high performance compensation wire for more reliable sensing.

(2) Measurement error

Do not mix up the direction of the input sensor connector.
Carefully adjust both load and sensor positions.
Make sure the sensor is securely attached to the input connector.

(3) AC power cable and wiring

Do not put the sensor lines in close proximity of the AC power lines.

4.1.2 Communication line wiring

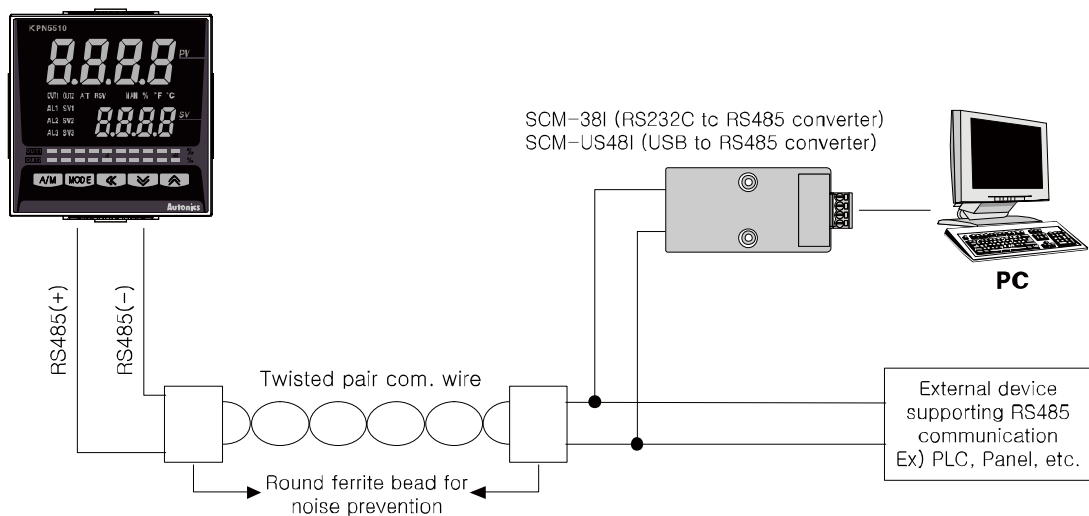

Note

Do not tie together with the AC power line.





Only use twisted pair wires for the communication lines. Do not allow the communication line to exceed 800m in length.

For further details, please refer to '6.6 Communication'.

5 Preparation and Startup

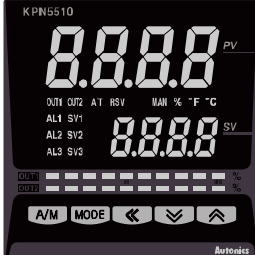
5.1 Powering ON and initial display

When supplying the power to the product, the display part flashes for 1 sec. It displays the model type (option, output, control output) and flashes the input type twice and it operates in RUN mode.

① Flashes whole display parts	② Displays model type	③ Flashes input type twice	④ RUN mode
			

5.2 Basic controls

5.2.1 Parameter setting sequence

Each parameter setting is related. Follow this sequence for initial setting.



Parameter 3 Group [PAr 3] → Parameter 4 Group [PAr 4] → Parameter 5 Group [PAr 5] →
 Parameter 2 Group [PAr 2] → Parameter 1 Group [PAr 1] → SV Setting Group [5v]



Note

Changing Parameter 3 Setting Group's parameters can sometimes reset other associated parameters. Always make sure to check if such parameters have been affected.









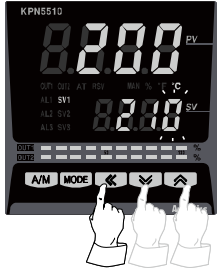

5.2.2 SV setting

You can set the temperature to control with , ,  keys.
Set range is within SV low-limit value [L - 5_u] to SV high-limit [H - 5_u] value.

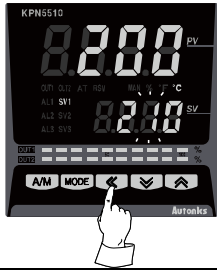

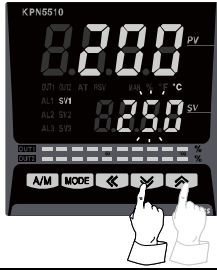
Ex.

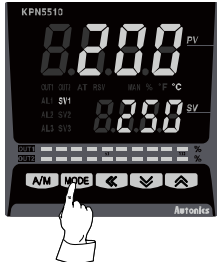
In case of changing set temperature from 210°C to 250°C

	<p>Press any key among , ,  in RUN mode to enter into SV setting mode. Last digit (10⁰ digit) on SV display part flashes.</p>
	<p>Press the  key to move digit. (10⁰ → 10¹ → 10² → 10³ → 10⁰)</p>
	<p>Press the ,  keys to raise or lower the setting value.</p>
	<p>Press the  key to save the setting value. If there is no additional key operation in 3 sec., the changed SV is automatically saved.</p>

5.2.3 MV Monitoring and Manual Control Setting

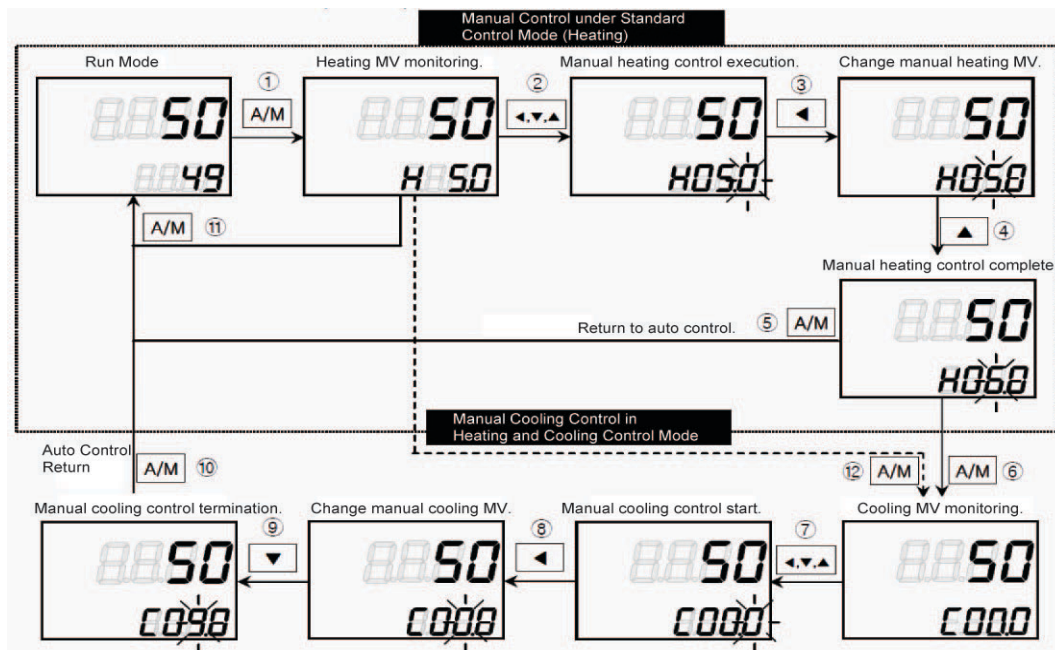

- ① While in Run mode, press the **(A/M)** key to commence manual control. The SV display showses **H** (heating control) or **C** (cooling control) and simultaneously displays the MV to indicate commencement of MV monitoring.
- ② If any one of **⏪**, **⏩**, **⏴** is pressed while MV monitoring is in progress, the MAN lamp turns on and the last digit flashes to indicate activation of manual control.
- ③ Press the **⏪** key to change the flashing digits. (10^0 10^1 10^2 10^3 10^0)
- ④ Select the digit and configure the desired MV value using the **⏴**, **⏵** keys.
- ⑤ To stop manual control, press the **(A/M)** key. The MAN lamp turns off, and the system returns to auto control mode.
- ⑥ While in heating and cooling control mode, set the manual heating MV and then press the **(A/M)** key to see **C** (cooling control) and the current cooling MV value on the SV display indicating commencement of cooling MV monitoring.
- ⑦ If any one of the **⏪**, **⏩**, **⏴** keys is pressed while MV monitoring is in progress, the MAN lamp turns on and the last digit flashes to indicate activation of manual control.
- ⑧ Press the **⏪** key to change the flashing digit. (10^0 10^1 10^2 10^3 10^0)
- ⑨ Select the digit and configure desired cooling MV value using the **⏴**, **⏵** keys.
- ⑩ To stop manual control, press the **(A/M)** key. The MAN lamp turns off, and the system returns to auto control mode.
- ⑪ While in standard control mode (heating control or cooling control), press the **(A/M)** key once from the MV monitoring stage, or any other stage. It returns to auto control mode.
- ⑫ During heating and cooling control mode, press the **(A/M)** key once from the MV monitoring stage, or any other stage. It skips the system to the cooling MV monitoring stage.



Note

For heating and cooling control, the system returns to auto control after going through heating monitoring, manual heating control, cooling monitoring, and manual cooling control stages in sequence.



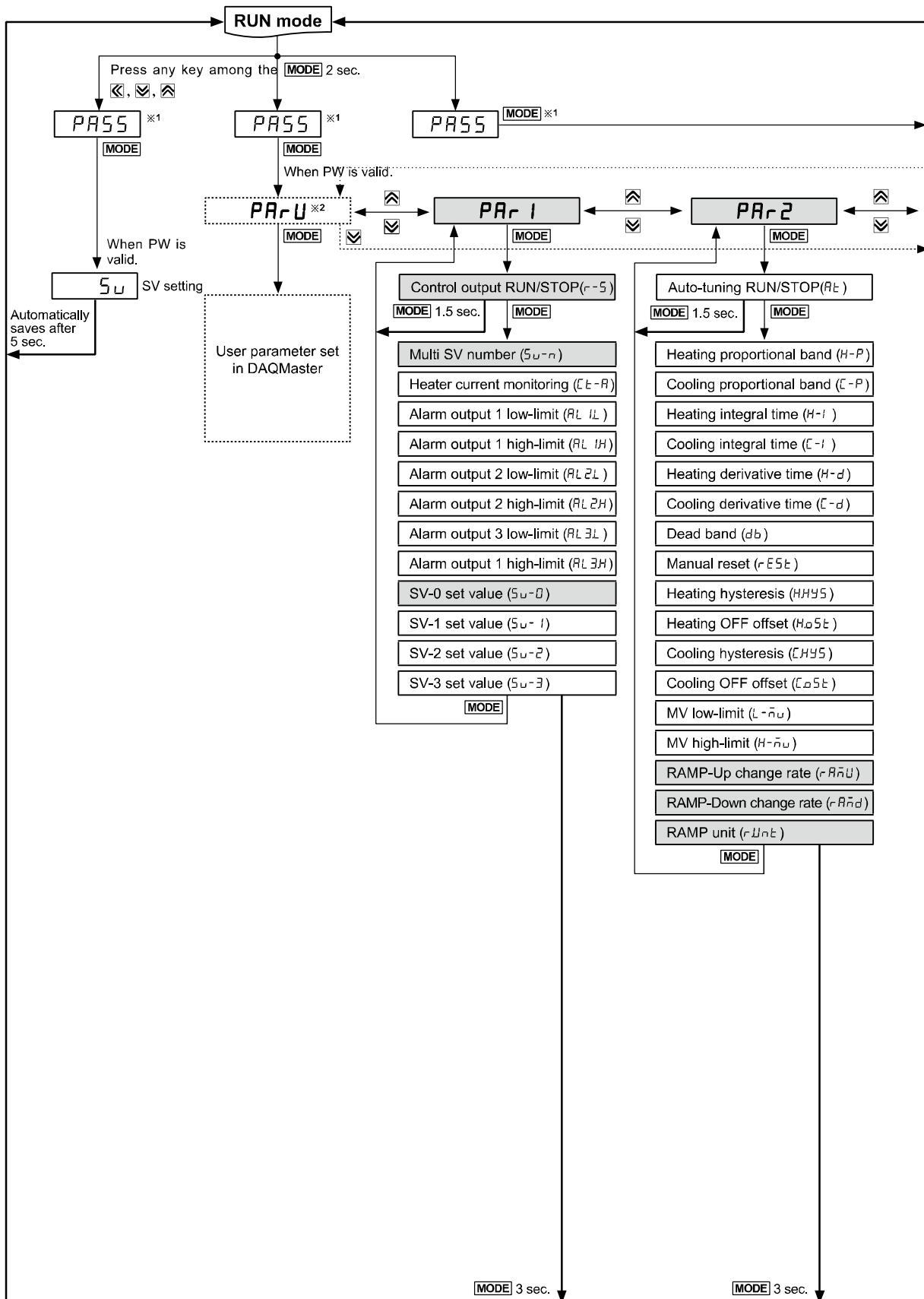

Heating MV remains in effect during cooling monitoring and manual cooling control.

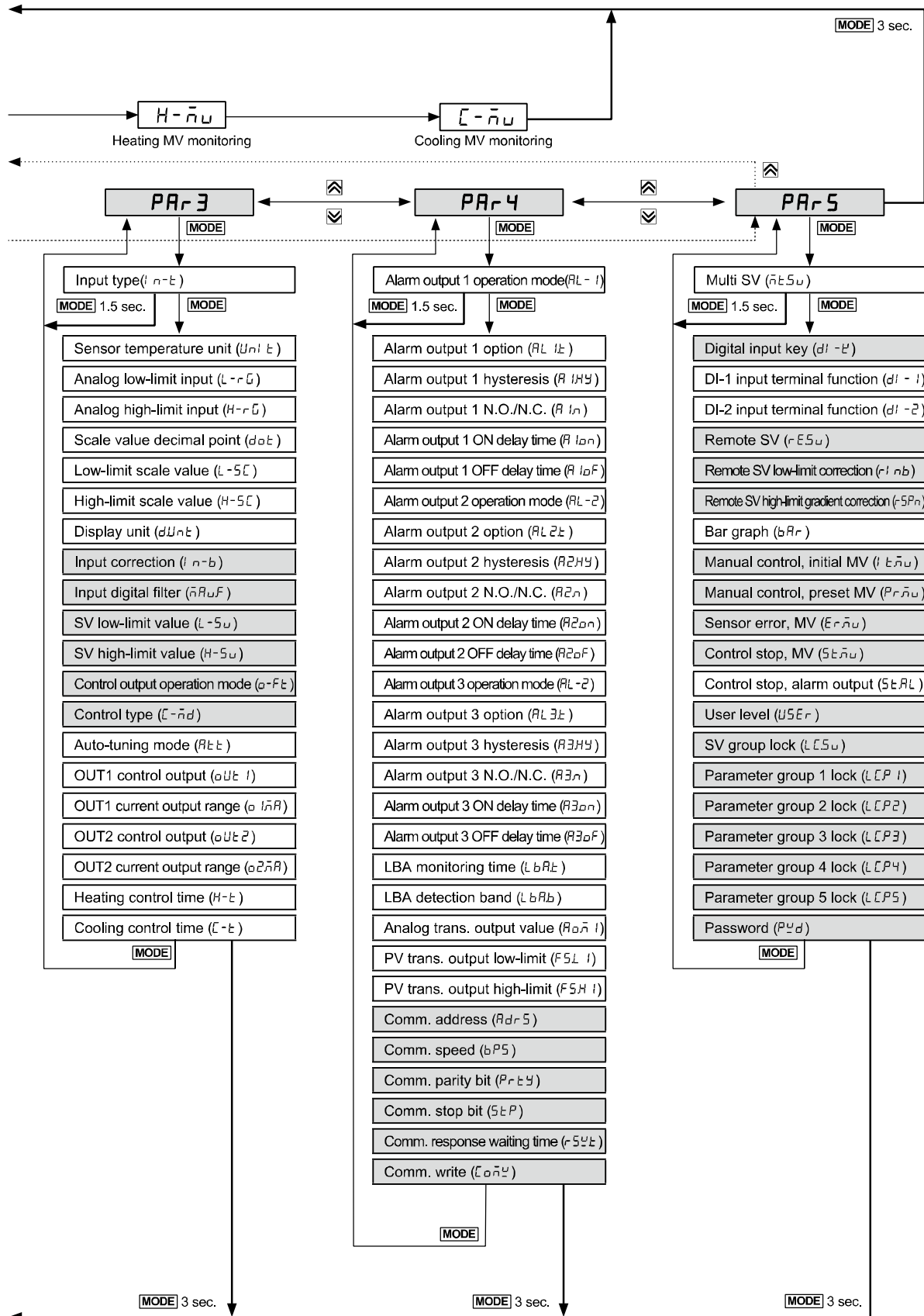
5.3 Parameter Reference Chart





※1. [P#55] parameter is displayed only when password is set. It is not displayed when purchasing the unit since the default password is set to [0000].







If the password is not valid, the screen is changed to the password code screen. Press any key among , ,  to return to password entering window. Press the  key to return to RUN mode.

If you forget the password, contact our service center after checking the password code.

※2. It is displayed when setting user parameter group in the integrated device management program (DAQMaster).



Note

- Press the  key over 2 sec. in RUN mode to enter into setting mode.
- Press the  key for 1.5 sec. while in setting mode to move to other parameter group.
- Press the  key over 3 sec. while in setting mode to return to RUN mode.
- Press the  key at the lowest level of parameter to move parameter group screen. Press ,  keys to move other parameter groups.
- If there is no additional key operation within 30 sec. after entering into setting mode, it is automatically returned to RUN mode and previous setting value remains.
- The shaded parameters are displayed in common. The others may not be displayed by the specifications of the product, other parameter's setting, or parameter mask setting.

5.4 Parameter Setting Groups

5.4.1 Parameter 1 Setting Group [PAR 1]

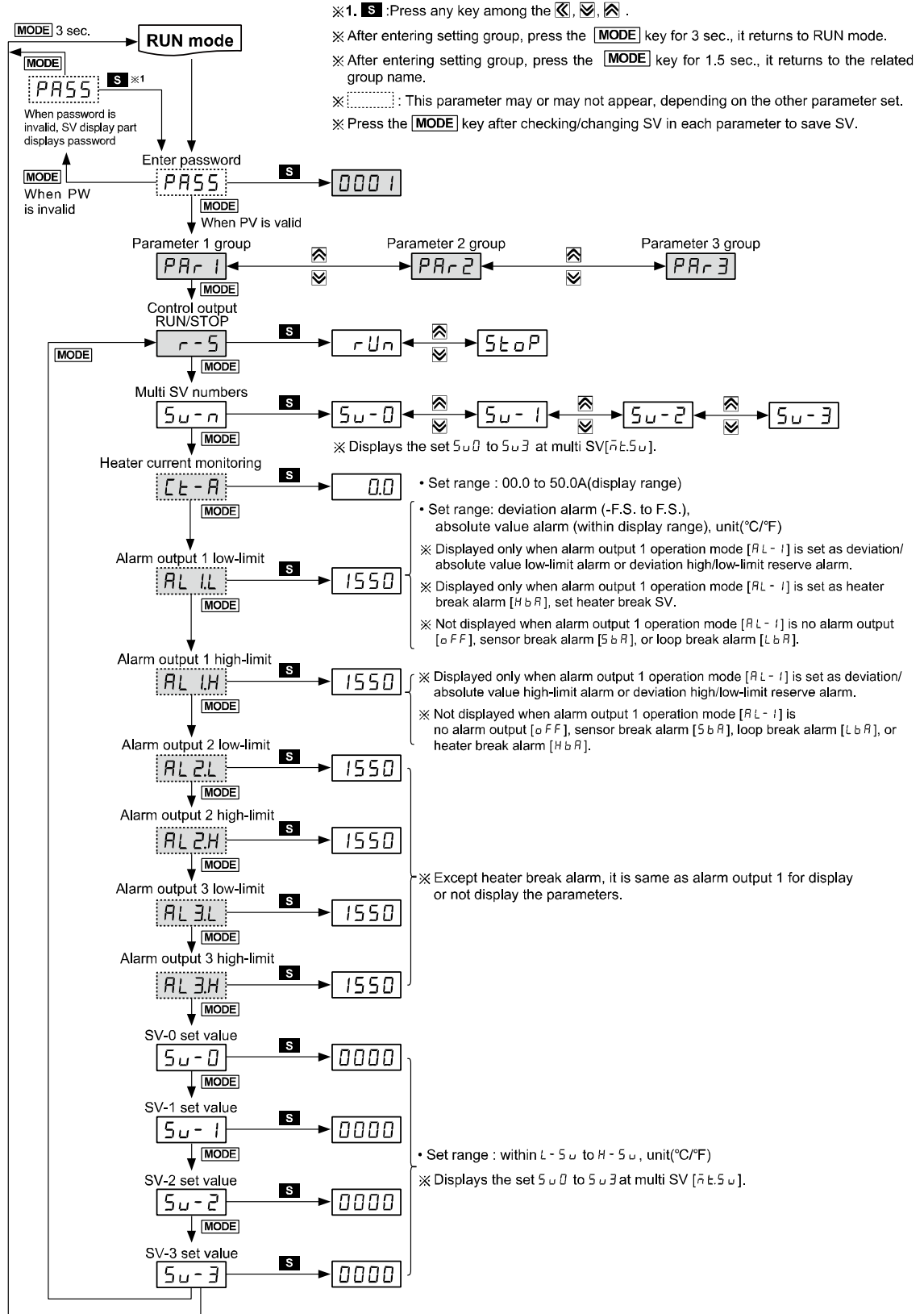

5.4.2 Parameter 2 Setting Group [PAR2]

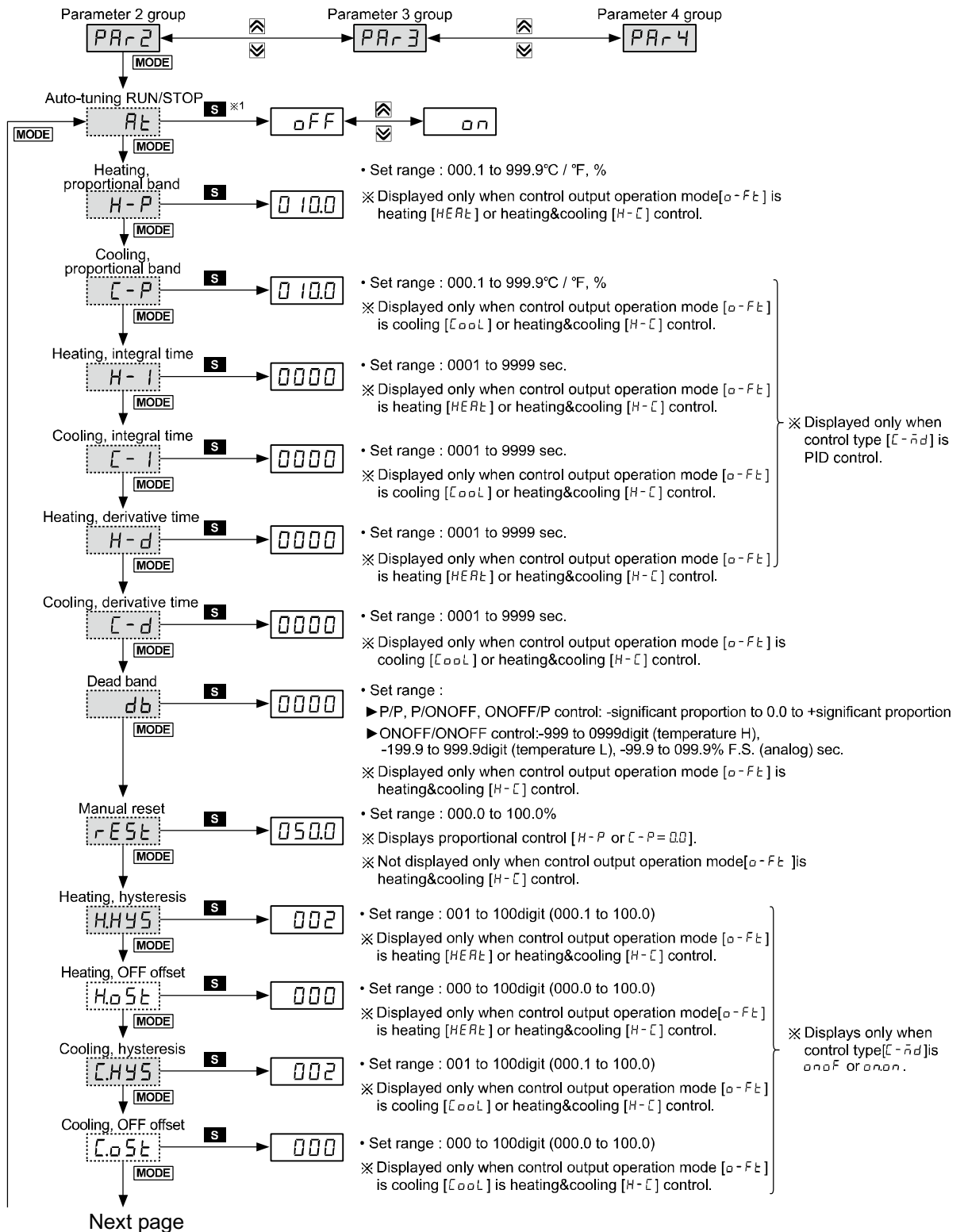

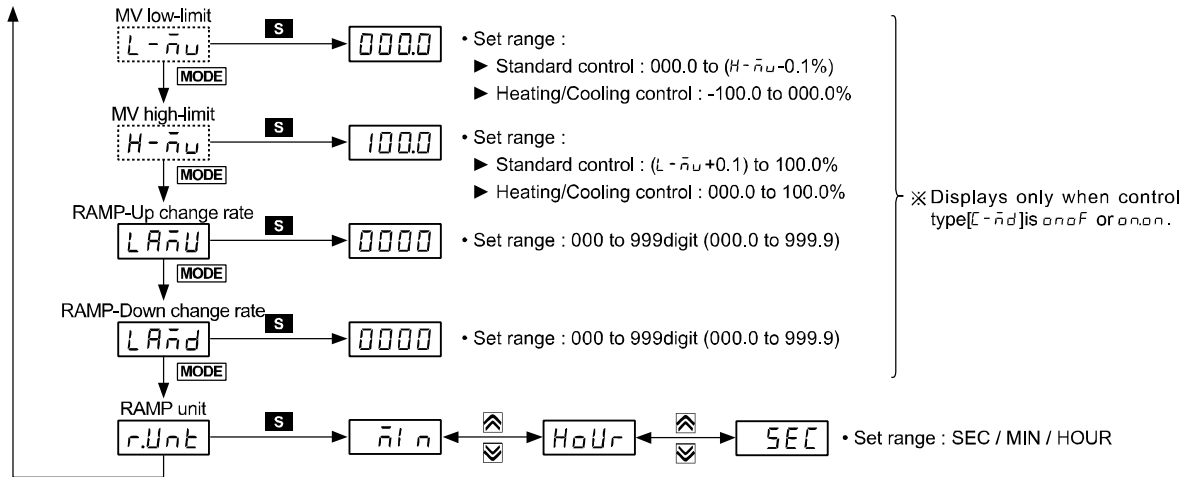

5.4.3 Parameter 3 Setting Group [PAR3]

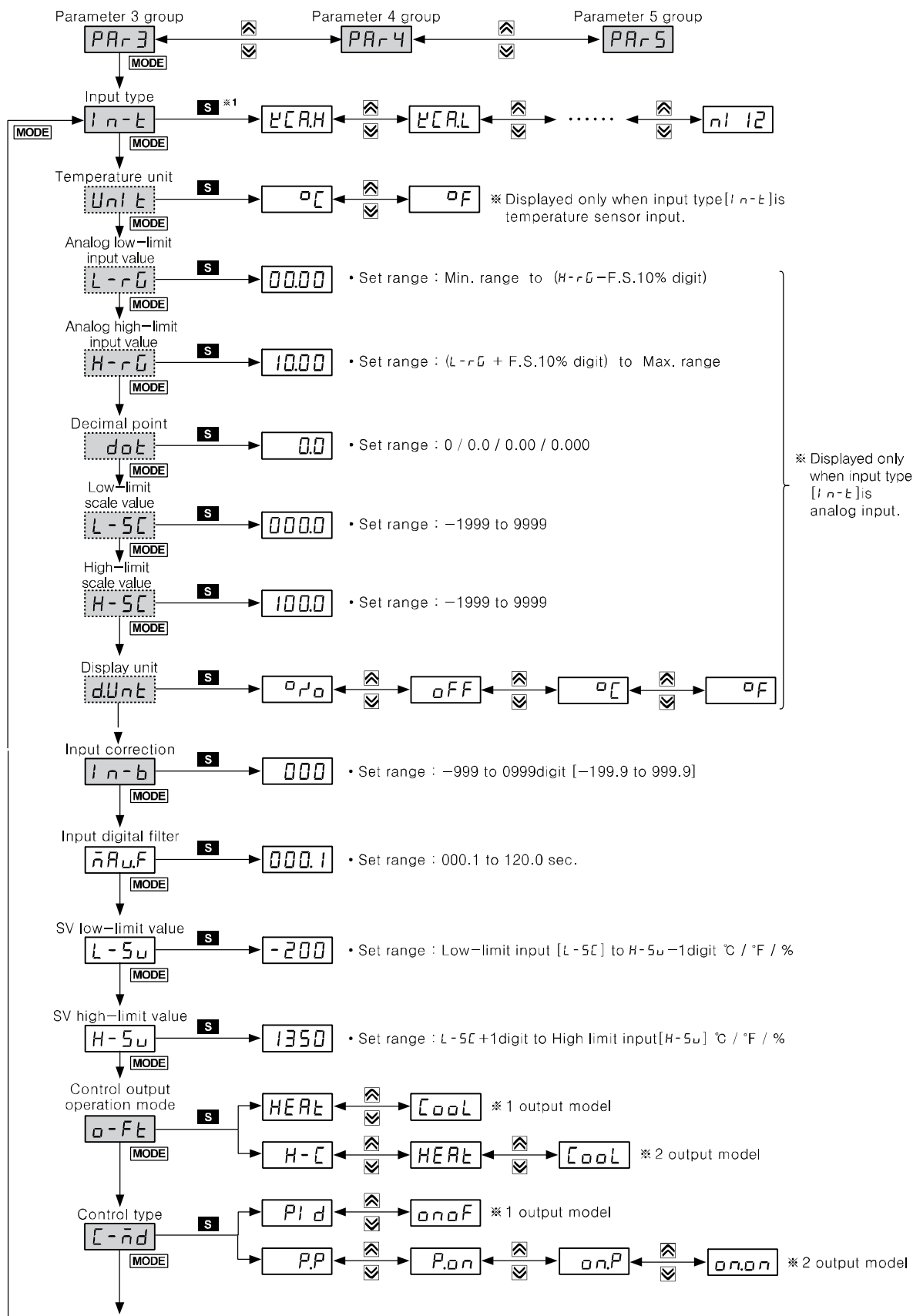

Next page

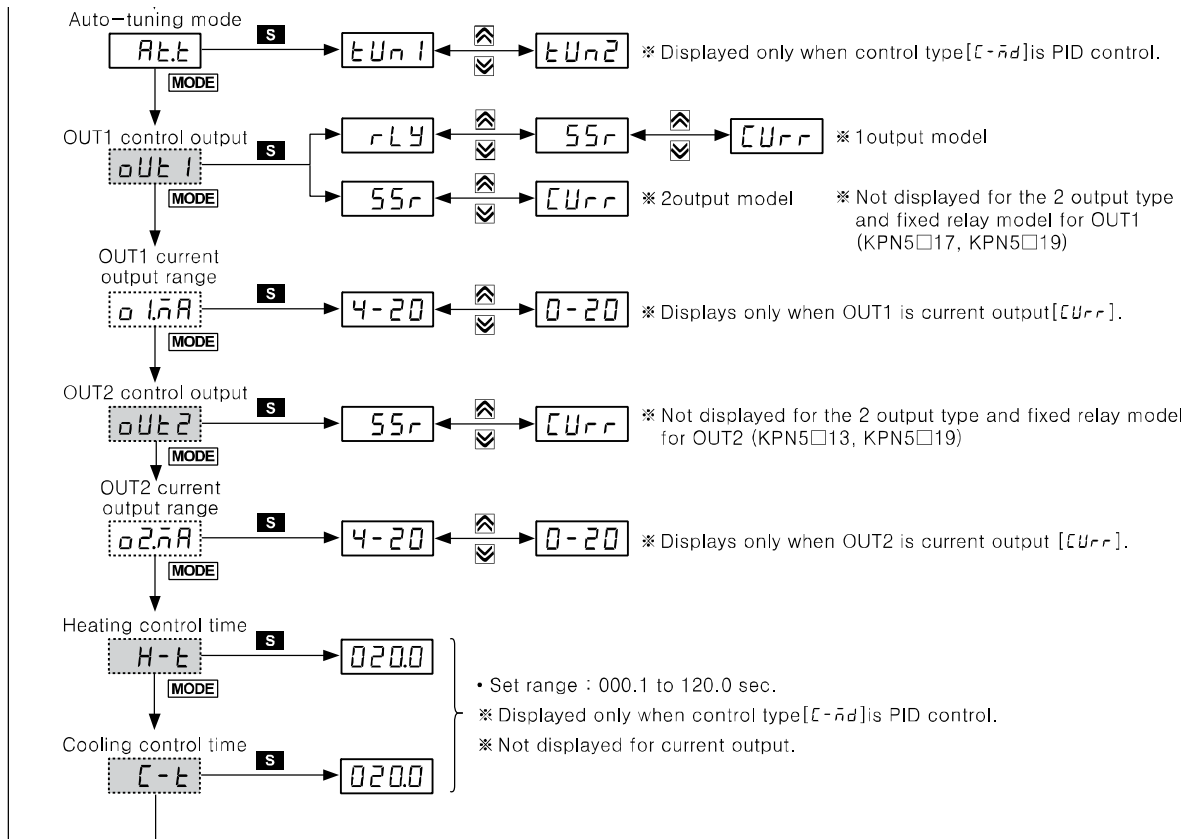

5.4.4 Parameter 4 Setting Group [PAR4]

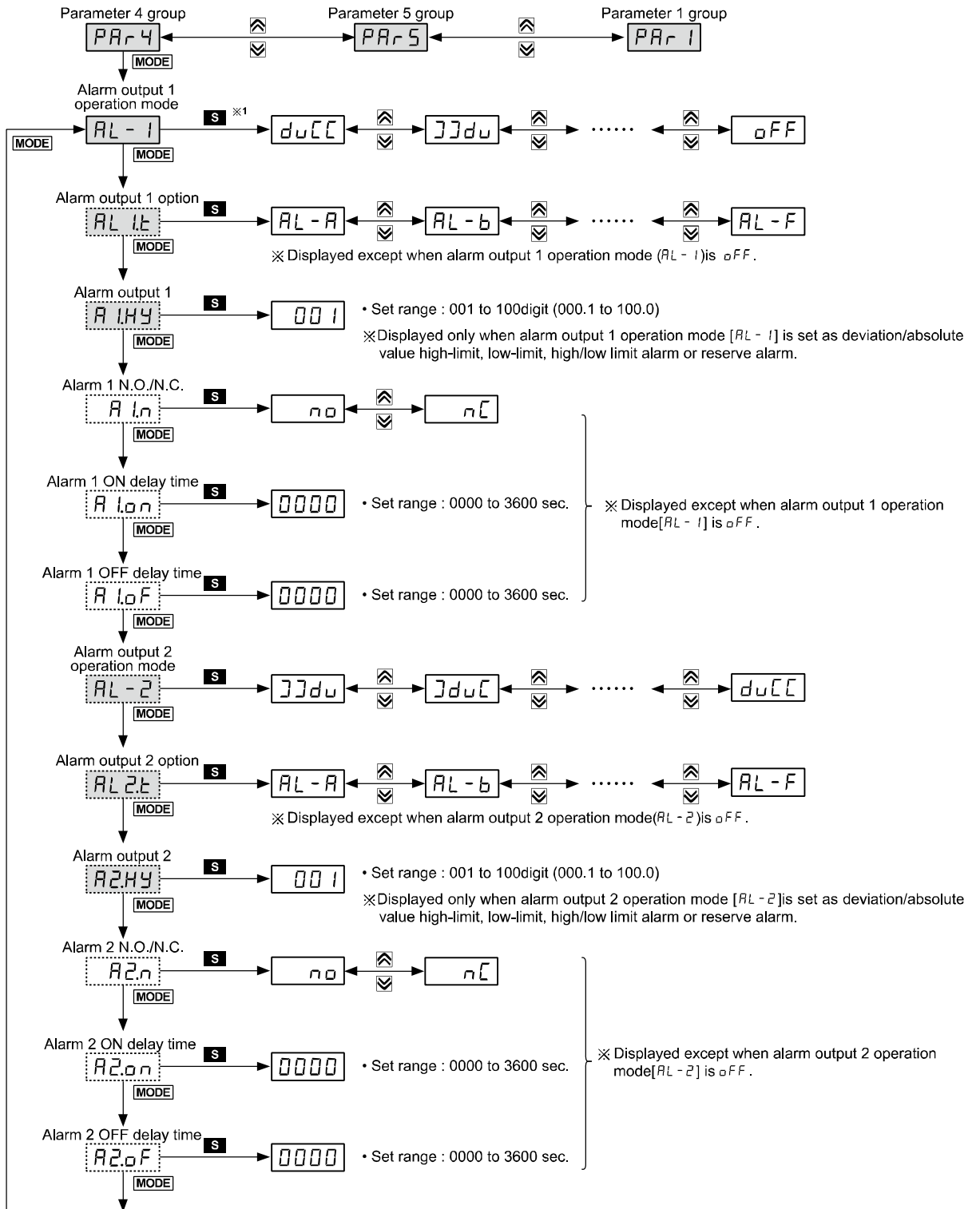

Next page

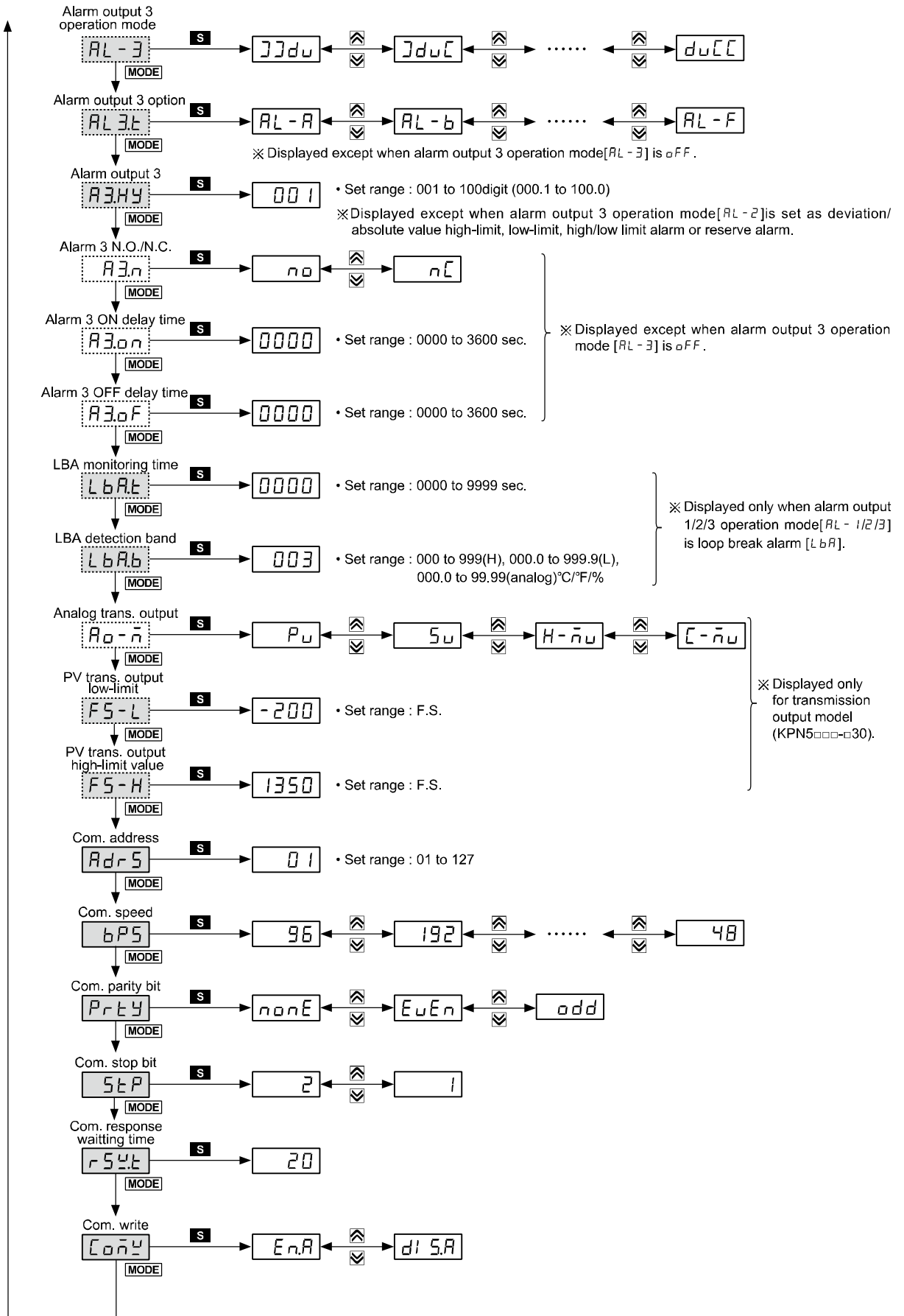

5.4.5 Parameter 5 Setting Group [PAR5]

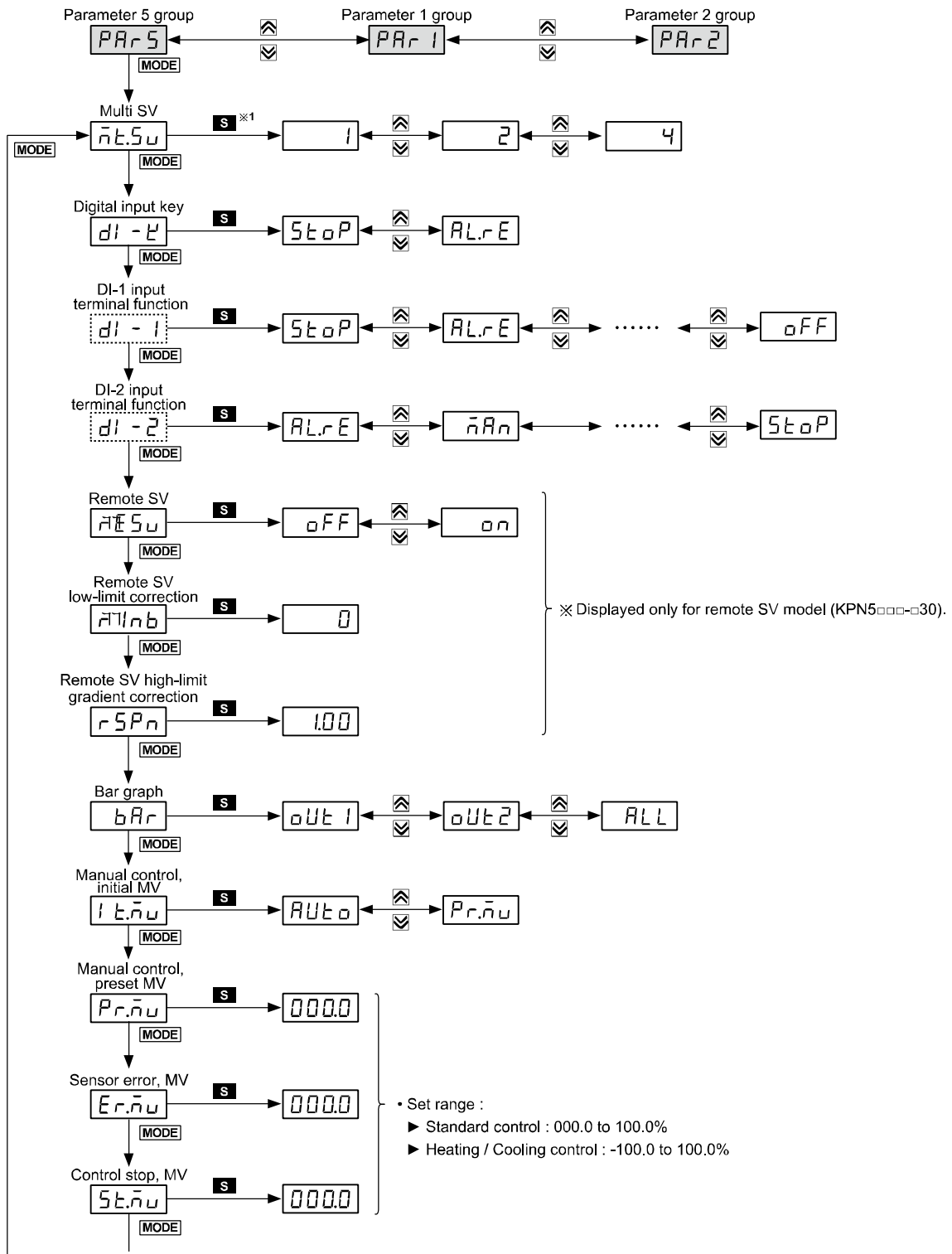

Next page

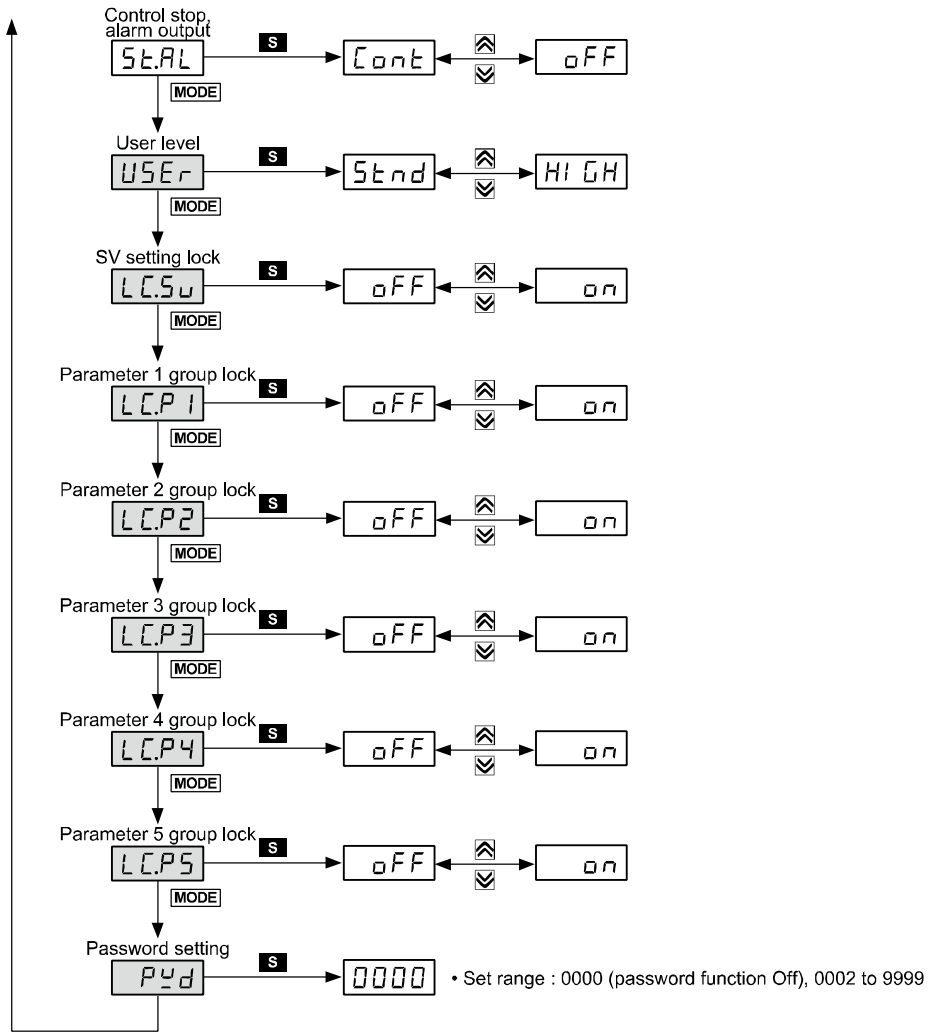

6 Parameter Settings and Functions

6.1 Input

6.1.1 Input types and temperature ranges

Input type			Display	Temp. range(°C)	Temp. range(°F)
Thermocouple (TC)	K(CA)	1	℄℄℄1	-200 to 1350	-328 to 2463
		0.1	℄℄℄2	-199.9 to 999.9	-199.9 to 999.9
	J(IC)	1	℄℄℄1	-200 to 800	-328 to 1472
		0.1	℄℄℄2	-199.9 to 800.0	-199.9 to 999.9
	E(CR)	1	℄℄℄1	-200 to 800	-328 to 1472
		0.1	℄℄℄2	-199.9 to 800.0	-199.9 to 999.9
	T(CC)	1	℄℄℄1	-200 to 400	-328 to 752
		0.1	℄℄℄2	-199.9 to 400.0	-199.9 to 752.0
	B(PR)	1	℄℄-b	0 to 1800	32 to 3272
	R(PR)	1	℄℄-r	0 to 1750	32 to 3182
	S(PR)	1	℄℄-s	0 to 1750	32 to 3182
	N(NN)	1	℄℄-n	-200 to 1300	-328 to 2372
	C(TT) ^{*1}	1	℄℄-℄	0 to 2300	32 to 4172
	G(TT) ^{*2}	1	℄℄-G	0 to 2300	32 to 4172
	L(IC)	1	℄℄℄1	-200 to 900	-328 to 1652
		0.1	℄℄℄2	-199.9 to 900.0	-199.9 to 999.9
U(CC)	1	℄℄℄1	-200 to 400	-328 to 752	
	0.1	℄℄℄2	-199.9 to 400.0	-199.9 to 752.0	
Platine II	1	℄℄-P	0 to 1390	32 to 2534	
RTD	Cu 50Ω	0.1	℄℄.50	-199.9 to 200.0	-199.9 to 392.0
	Cu 100Ω	0.1	℄℄.10	-199.9 to 200.0	-199.9 to 392.0
	JPt 100Ω	1	℄℄℄.1	-200 to 650	-328 to 1202
		0.1	℄℄℄.2	-199.9 to 650.0	-199.9 to 999.9
	DPt 50Ω	0.1	℄℄℄.5	-199.9 to 600.0	-199.9 to 999.9
	DPt 100Ω	1	℄℄℄.1	-200 to 650	-328 to 1202
		0.1	℄℄℄.2	-199.9 to 650.0	-199.9 to 999.9
Nickel 120Ω	1	ni.12	-80 to 200	-112 to 392	
Analog	Voltage	0 to 10V	℄-v1	-1999 to 9999 (Display range is variable according to decimal point position.)	
		0 to 5V	℄-v2		
		1 to 5V	℄-v3		
		0 to 100mV	℄.m1		
	Current	0 to 20mA	℄.A1		
		4 to 20mA	℄.A2		

※1: C(TT) : Same as existing W5(TT) type sensor

※2: G(TT) : Same as existing W(TT) type sensor



Note

Temperature sensors convert the subject temperature to electrical signals for the temperature controller allowing it to control output.

SV (Setting Value) can only be set within the input range.

6.1.2 Input type [PAR3 → I n-t]

This product supports multiple input types, making it possible for the user to choose from thermocouples, RTDs, and analog voltage/current.

If you change the input specification, the SV's high/low limits are automatically set to the new specification's max/min values for temperature sensors. As for analog inputs, high/low input values are set to the max/min temperature range and the SV high/low limits set to high/low scale values.

Setting group	Parameter	Set range	Factory default	Unit
PAR3	I n-t	Refer to 6.1.1	U C A.H	-

6.1.3 Sensor temperature unit [PAR3 → U n l t]

When selecting the input temperature sensor, you can set the desired units (°C, °F) of temperature value to be displayed.

Setting group	Parameter	Set range	Factory default	Unit
PAR3	U n l t	°C / °F	°C	-



Note

This parameter is not displayed for analog input.

6.1.4 Analog input/scale value

With analog input selected, you can set the analog input range (high/low limit input values) and the display scale (high/low limit scale values) within the designated input range.

The decimal point positions remain fixed when configuring the high/low limit input values. You can change the input values at $PA1$: 00.00, $PA2/PA3$: 0.000, $PA4$: 000.0, $PA5$ / $PA6$: 00.00 decimal points.

If the upper and lower limit scale settings are identical, Err flashes twice and setting mode is displayed.

For analog input, $\pm 5\%$ of the set high/low limit input value is extended. Analog output is also extended comparing input value. (For temperature sensor input, $\pm 5\%$ extension is applied within the temperature range.)

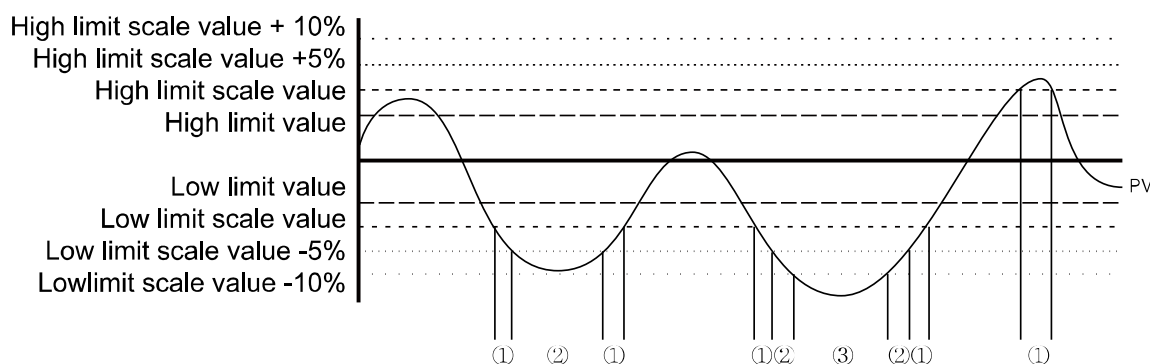

No	PV	Display
①	$\pm 5\%$ section	Flashes PV
②	± 5 to 10% section	Flashes HHHH or LLLL
③	over $\pm 10\%$ section	Flashes σPEn



Note

This parameter is not displayed for temperature sensor input.

6.1.4.1 Analog low-limit input value [$PA3 \rightarrow L-rG$]

You can set the low limit input values for actual use within the analog input range.

Setting group	Parameter	Set range	Factory default	Unit
$PA3$	$L-rG$	Min. temperature range to high limit input value [$H-rG$] - F.S. 10%	00.00	-

6.1.4.2 Analog high-limit input value [$PA3 \rightarrow H-rG$]

You can set the high limit input values for actual use within the analog input range.

Setting group	Parameter	Set range	Factory default	Unit
$PA3$	$H-rG$	Low limit input value [$L-rG$] + F.S. 10% to Max. temperature range	10.00	-

6.1.4.3 Decimal point [PAR3 → dot]

You can set the decimal point positions for PV (Present Value) and SV (Setting Value) within high and low limit scale values.

Setting group	Parameter	Set range	Factory default	Unit
PAR3	dot	0 / 0.0 / 0.00 / 0.000	0.0	-

6.1.4.4 Scale low-limit value [PAR3 → L-SC]

You can set the display scales of lower limit values for analog input [L-rc].
(Based on the decimal point position setting.)

Setting group	Parameter	Set range	Factory default	Unit
PAR3	L-SC	-9999 to 9999	000.0	-

6.1.4.5 Scale high-limit value [PAR3 → H-SC]

You can set the display scales of high limit values for analog input [H-rc].
(Based on the decimal point position setting.)

Setting group	Parameter	Set range	Factory default	Unit
PAR3	H-SC	-9999 to 9999	100.0	-

6.1.4.6 Display unit [PAR3 → d.Unt]

When you select analog input type, you can set the display units.

Setting group	Parameter	Set range	Factory default	Unit
PAR3	d.Unt	°C / °F / % / OFF	%	-

Setting	Parameter function
°C	Sets the display unit to °C and turns on the °C indicator.
°F	Sets the display unit to °F and turns on the °F indicator.
%	Sets the display unit to % and turns on the % indicator.
OFF	Sets the display unit to an undefined unit. The LED unit indicator does not turn on.

6.1.5 Input correction [$PAR3 \rightarrow In-b$]

This feature is used to compensate for input error caused by thermocouples, RTDs, or analog input devices, not by the controller itself.

This input correction function is mainly used when the sensor cannot be attached directly to controlled objects. It is also used to compensate for temperature error between the sensor's installation point and the actual measuring point.

Setting group	Parameter	Set range	Factory default	Unit
$PAR3$	$In-b$	-999 to 0999 (Temperature H, Analog),	0000	°C/°F/-
		-199.9 to 999.9 (Temperature L)		



Ex.

If the controller displays 78°C when the actual temperature is 80°C, set the input bias [$In-b$] to '002' in order to adjust the controller's display temperature to 80°C.

After input correction, the PV is out of the temperature range by each sensor, it displays 'HHHH' or 'LLLL'.



Note

Make sure that an accurate temperature error measurement is taken before setting values of input correction. An inaccurate initial measurement can lead to greater error.

Many of today's temperature sensors are graded by their sensitivity. Since higher accuracy usually comes at a higher cost, most people tend to choose sensors with medium sensitivity. Measuring each sensor's sensitivity correction for input correction function in order to ensure higher accuracy in temperature reading.

6.1.6 Input digital filter [$PAR3 \rightarrow nAUF$]

It is not possible to perform high accuracy control if the PV (Present Value) fluctuates because of noise elements, disturbance, or instabilities in the input signal. Using the input digital filter function can stabilize PV to realize more reliable control.

Setting group	Parameter	Set range	Factory default	Unit
$PAR3$	$nAUF$	000.1 to 120.0	000.1	sec.



Ex.

If the input digital filter is set to 0.4 seconds, digital filtering is applied to a sampling value collected over 0.4 seconds (400 ms).



Note

When the input digital filter is used, PV (Present Value) can vary from the actual input value.

6.1.7 SV high/low limit value [$PAR\ 3 \rightarrow H-5\mu/L-5\mu$]

You can limit the SV (Setting Value) range within the temperature range of the sensor or analog input type in order to prevent the system from controlling with improper SV.

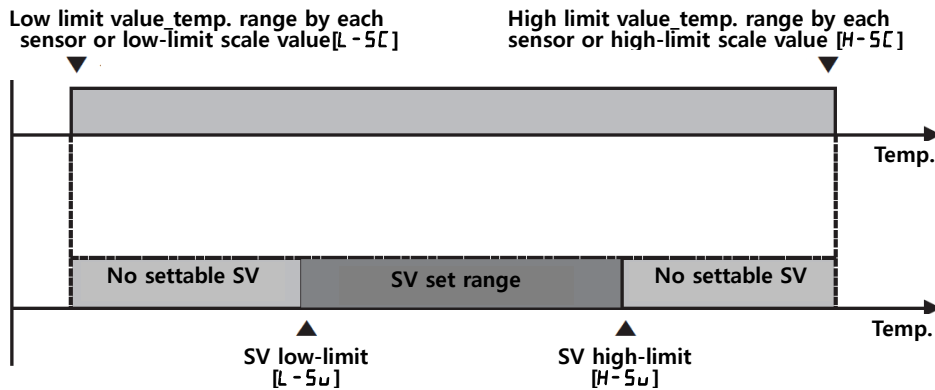

Setting group	Parameter	Set range	Factory default	Unit
$PAR\ 3$	$H-5\mu$ SV high-limit value	SV low-limit [$L-5\mu$]+ 1digit to high limit value by each sensor or high-limit scale value [$H-5\mu$]	1350 (Temp.) 000.0 (Analog)	°C/°F
	$L-5\mu$ SV low-limit value	SV low-limit [$L-5\mu$] or low-limit scale value [$L-5\mu$] to SV high-limit [$H-5\mu$] or high-limit scale value [$H-5\mu$]	-200 (Temp.) 100.0 (Analog)	



Note

If setting over or below of high/low-limit input range of input temperature sensor type or high/low-limit scale value of analog, the SV is not saved and the previous settings are retained.

SV is available to set within the 'SV low-limit [$L-5\mu$] to SV high-limit [$H-5\mu$]' range. You can not set SV as 'SV low-limit [$L-5\mu$] > SV high-limit [$H-5\mu$]'.

6.2 Control output

6.2.1 Control output mode [$PAR3 \rightarrow \alpha-FE$]

Control output modes for general temperature control include heating [$HEAT$], cooling [$COOL$], and heating and cooling [$H-C$].

Heating control and cooling control are mutually opposing operations with inverse outputs.

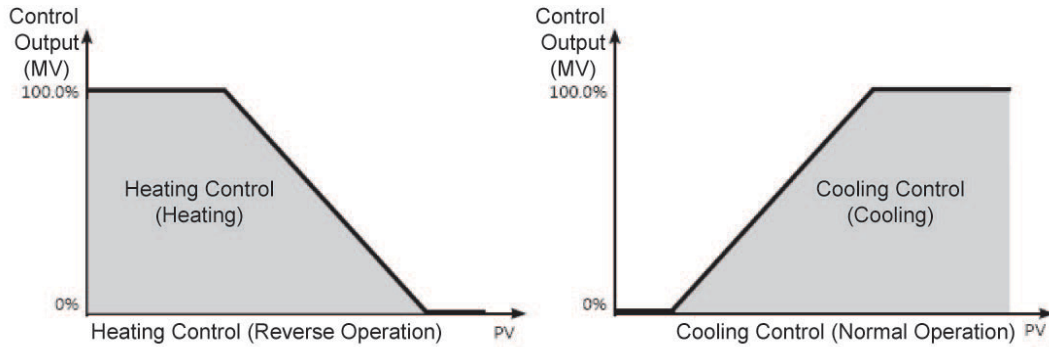

The PID time constant varies based on the controlled objects during PID control.

Setting group	Parameter	Set range	Factory default	Unit
$PAR3$	$\alpha-FE$	Standard model: $HEAT / COOL$	$HEAT$	-
		Heating & Cooling model: $HEAT / COOL / H-C$	$H-C$	-

6.2.1.1 Heating control [$PAR3 \rightarrow \alpha-FE \rightarrow HEAT$]

As reverse operation, if PV is lower than SV, it is set the output to supply power to the load(heater).

6.2.1.2 Cooling control [$PAR3 \rightarrow \alpha-FE \rightarrow COOL$]

As normal operation, if PV is higher than SV, it is set the output to supply power to the load (cooler).

6.2.1.3 Heating & Cooling control [$PAR3 \rightarrow o-Fl \rightarrow H-C$]

Heating and cooling with a single temperature controller when it is difficult to control subject temperature with only heating or cooling.

Heating and cooling control mode controls the object using different PID time constants for each heating and cooling.

It is also possible to set heating and cooling control in both PID control or ON/OFF control mode. Heating/cooling output can be selected among Relay output, SSR output and current output depending on model types chosen according to your application environment. (Note that only standard SSR control is available for SSR output in OUT2.)

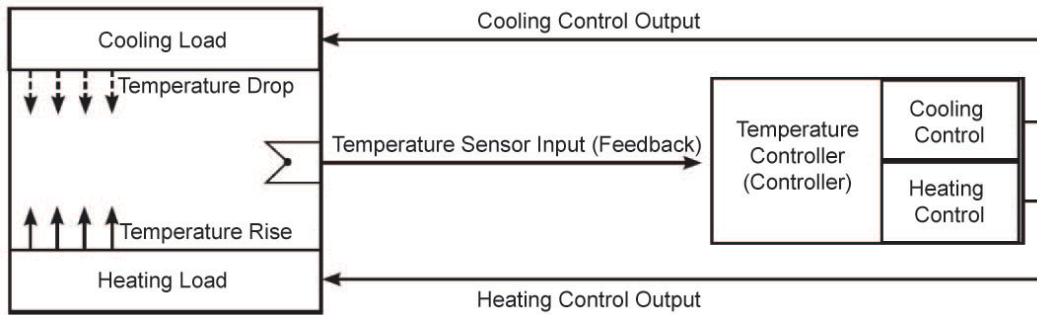

Note

For heating and cooling control, OUT1 control output is dedicated to heating control and OUT2 control output to cooling control.

6.2.1.3.1. Dead band/Overlap band [$PAR2 \rightarrow db$]

In heating and cooling control, it is possible to designate a dead band between heating and cooling control bands based on SV (Setting Value).

A dead band forms around the SV when db is set to a positive value (+). No control occurs in the dead band area. Therefore, heating and cooling MVs become 0.0% in the formed dead band. An overlap band (simultaneous application of heating and cooling MVs) forms around the SV when db is set to a negative value (-).

Set db to 0 when a dead band or an overlap band is not used.

Setting group	Parameter	Set range	Factory default	Unit
$PAR2$	db	Refer to the below.	Refer to the below.	

- PID/PID, PID/ON-OFF, ON-OFF/PID control
 - Set range (temperature): -(proportional band) to +(proportional band) (based on the lower value when proportional bands are different)
 - Set range (analog): -99.9 to 099.9
 - Factory default: 0000(temperature H), 000.0(temperature L, analog), (unit: temperature °C/°F, analog % F.S.)
- ON-OFF/ON-OFF control
 - Set range (temperature):
 - 999(overlap band) to 0000(not used) to 0999(dead band) (temperature H)
 - 199.9(overlap band) to 000.0(not used) to 999.9(dead band) (temperature L)
 - Set range (analog): -99.9(overlap band) to 000.0(not used) to 099.9(dead band)
 - Factory default: 0000(temperature H), 000.0(temperature L, analog), (Unit: temperature °C/°F, analog % F.S.)

(1) Using dead band

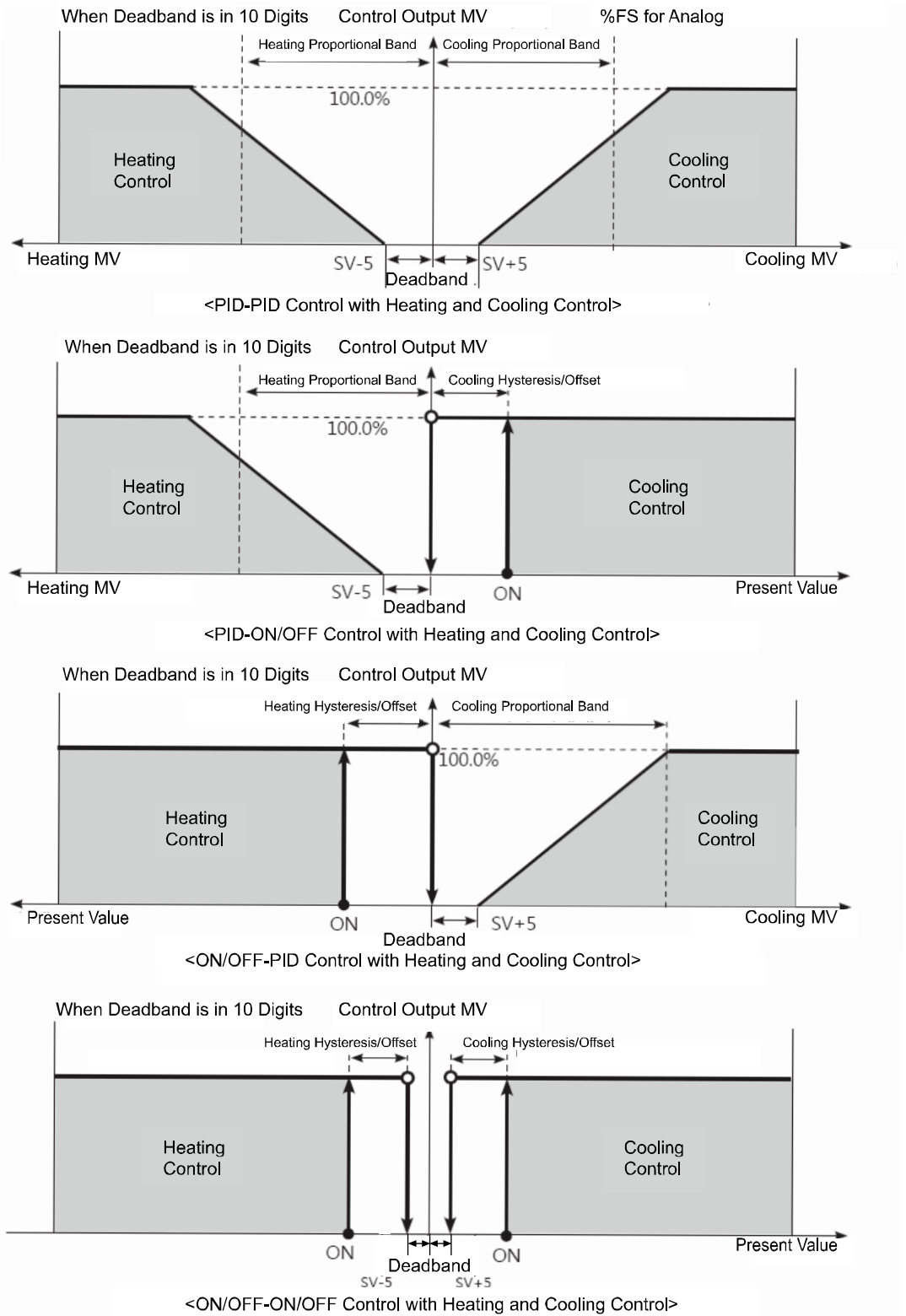

(2) Using overlap band

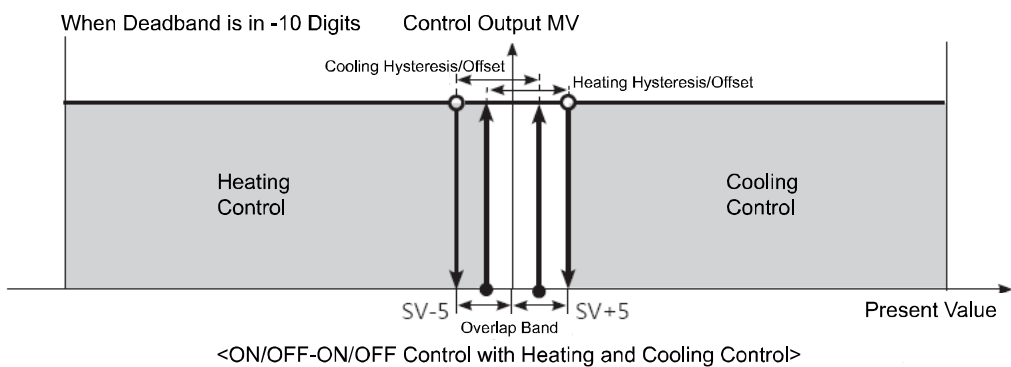
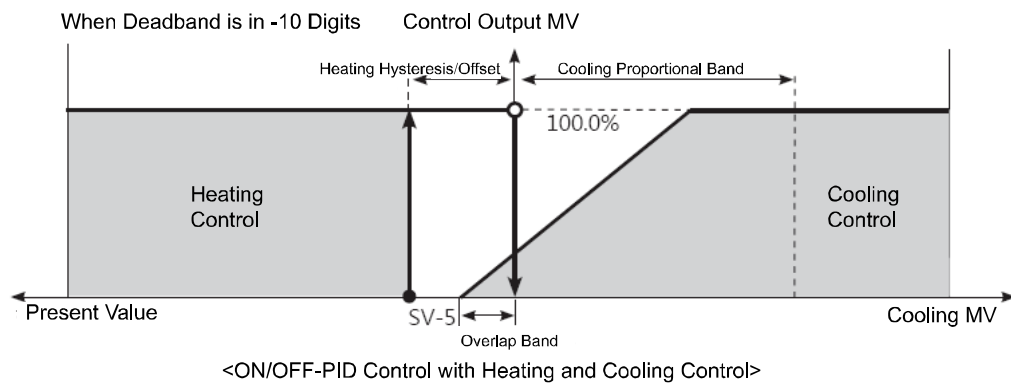
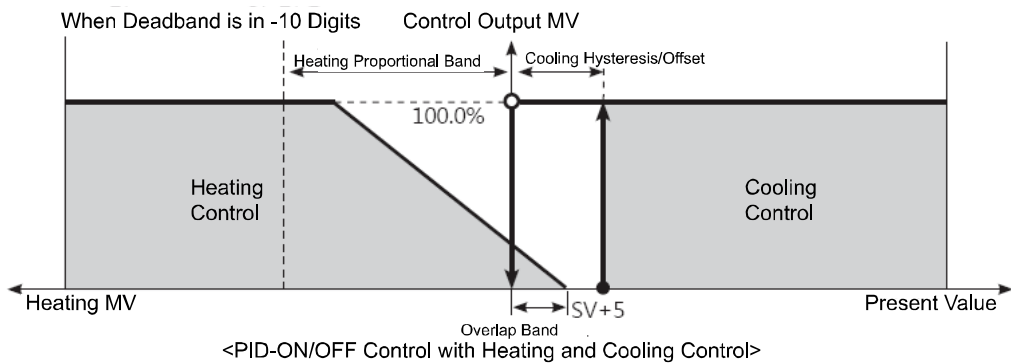
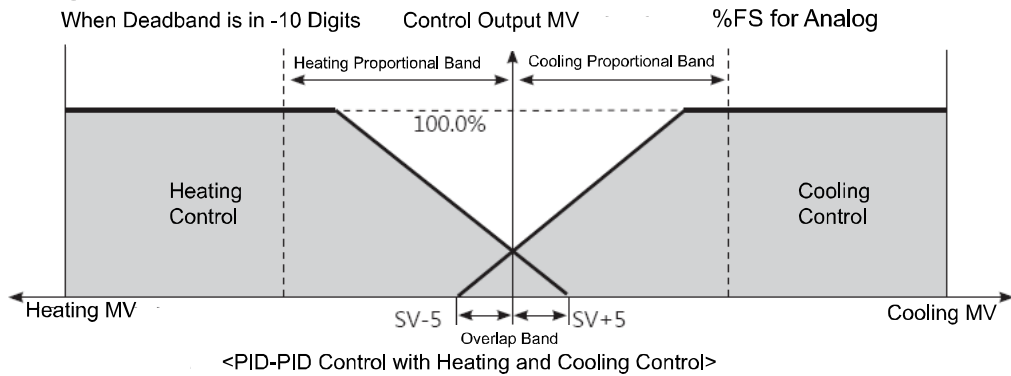

(3) Using neither dead band nor overlap band

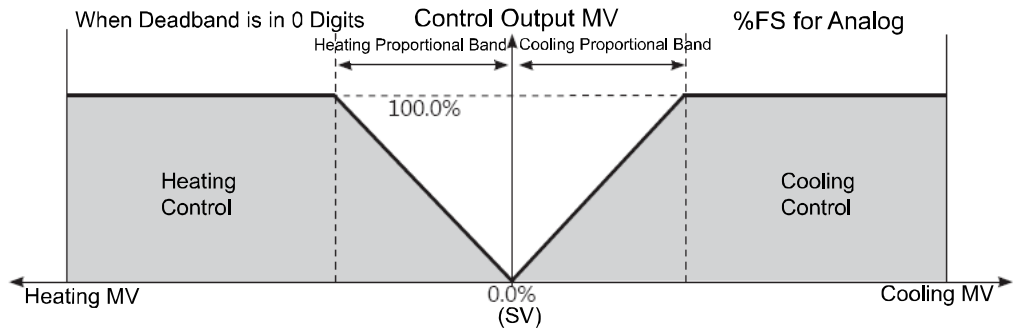

<PID-PID Control with Heating and Cooling Control>

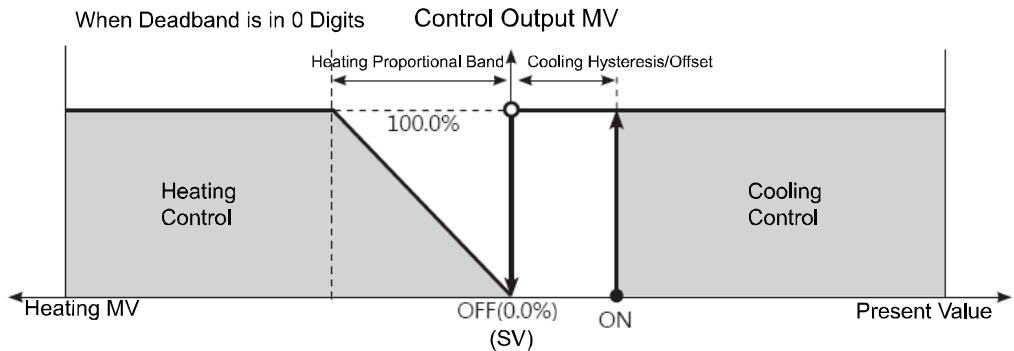

<PID-ON/OFF Control with Heating and Cooling Control>

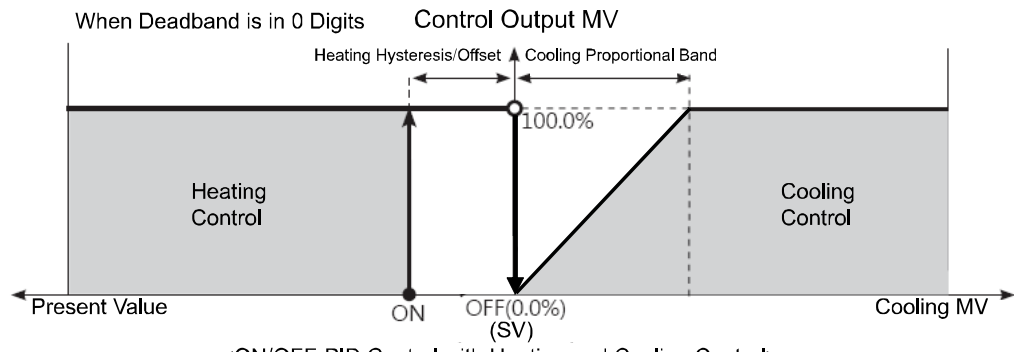

<ON/OFF-PID Control with Heating and Cooling Control>

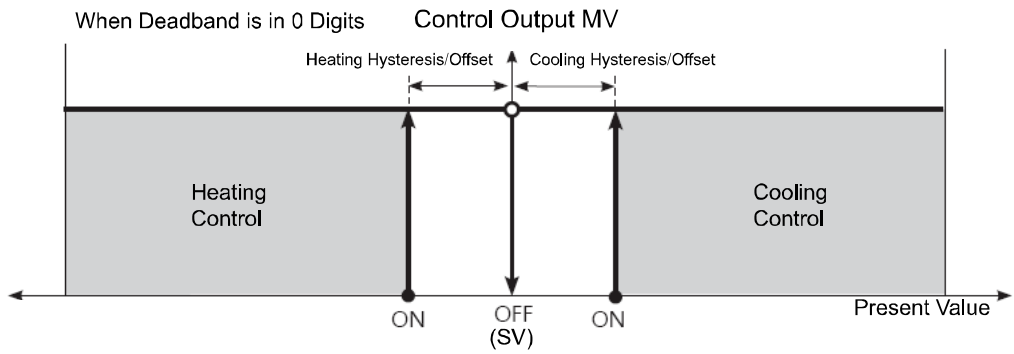

<ON/OFF-ON/OFF Control with Heating and Cooling Control>

6.2.2 MV high/low-limit [$PAR2 \rightarrow H-\bar{n}u / L-\bar{n}u$]

MV high/low-limit values [$H-\bar{n}u / L-\bar{n}u$] for control output can be configured to the actual MV, provided the temperature controller's MV calculation exceeds the limits.

During heating and cooling control, cooling MV carries a "-" prefix. Therefore, the high-limit is expressed as a + value on the heating side and the lower limit as a - value on the cooling side.

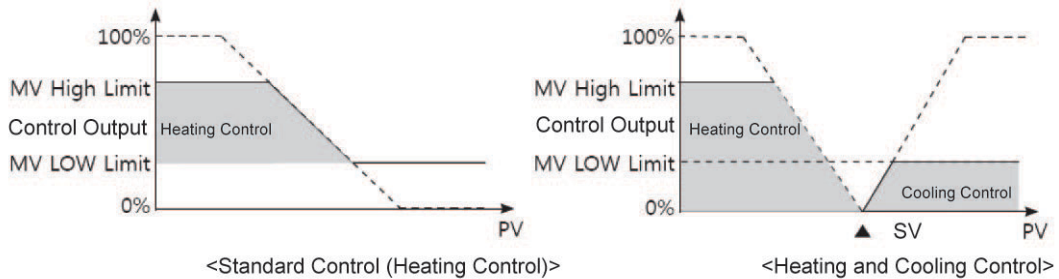

Parameter	Description
$L-\bar{n}u$	MV low-limit set
$H-\bar{n}u$	MV high-limit set

Setting group	Parameter	Set range	Factory default	Unit
$PAR2$	$H-\bar{n}u$	Standard control: MV low-limit value [$L-\bar{n}u$] + 0.1 to 100.0	100.0	%
		Heating & Cooling control: 000.0 to 100.0 (PID control) 0.0 (OFF)/ 100.0 (ON) (ON/OFF control)	100.0	%
	$L-\bar{n}u$	Standard control: 000.0 to MV high-limit value [$H-\bar{n}u$] - 0.1	0.0	%
		Heating & Cooling control: - 100.0 to 000.0 (PID control), +100.0 (ON)/0.0 (OFF) (ON/OFF control)	-100.0	%



Note

Same MV limits applied during auto-tuning.

MV limits are not applied to manual control, MV upon control stop, MV upon a sensor error, and initial manual control MV.

MV high/low-limit configuration is not available for ON/OFF control in standard control mode (heating or cooling control).

6.2.3 RAMP [PAR2 → rAñU / rAñd / r.Unt]

Ramp is a feature used to configure the slope toward SV (Setting Value). The feature limits change rate of SV and thereby restricts sudden temperature changes (increase and decrease) in the control subject.

Ramp is commonly used in applications where rapid temperature changes (increase and decrease) could impact negatively on the control subject.

Parameter	Description
rAñU	RAMP-Up change rate
rAñd	RAMP-Down change rate
r.Unt	RAMP time unit set

Setting group	Parameter	Set range	Factory default	Unit
PAR2	rAñU	000 to 999 (temperature H, analog), 000.0 to 999.9 (temperature L)	000	
	rAñd	000 to 999 (temperature H, analog), 000.0 to 999.9 (temperature L)	000	
	r.Unt	SEC (sec.), ñl n (min.), Hour (hour)	ñl n	-



Note

Activating the ramp feature when the ramp is not in operation limits the change rate of SV (Setting Value) based on PV (Present Value). Changing SV or ramp parameters while the ramp is in operation limits the change rate of SV based on SV at the point of the change. Control operates based on changed SV (hereinafter referred to as RAMP SV) - changed by preset change rate (slope). Set RAMP-Up change rate and RAMP-Down change rate independently.

During RAMP operation, Alarm operates based on the last SV.

Setting the rate of ramp change to 0 deactivates the ramp feature.

If the ramp feature has been activated, RAMP SV is displayed on SV display part.

RAMP feature by operation status

Operation status	Ramp Up/Down	RAMP feature
All operations	When it is 0	Inactive
PEñ, HHHH, LLLL, Auto-Tuning, Auto → Manual, RUN → STOP	Regardless of conditions	Inactive
PEñ, HHHH, LLLL, after completing Auto-Tuning, PV = SV	Regardless of conditions	Inactive
Power ON, SV changing, STOP → RUN, Manual → Auto, Ramp Rate changing	When it is not 0	Active

RAMP feature operation graph

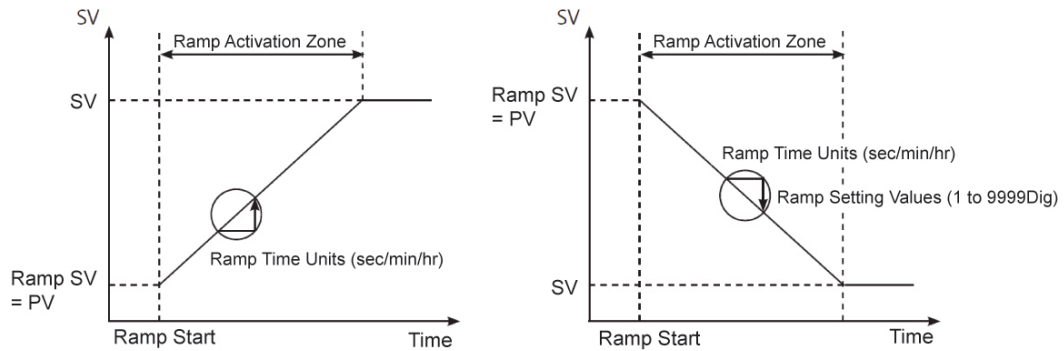

<Activating Ramp when Ramp is not in operation>

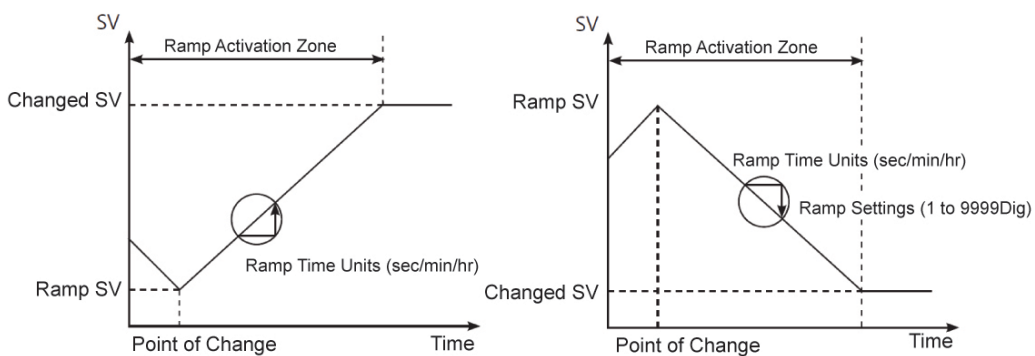

<Changing SV or Ramp Parameter when Ramp is in operation>

6.2.4 Auto/ Manual control

- Auto control: This mode is to make temperature reach SV with MV calculated by PID control.
- Manual control: This mode is to make temperature reach SV with user's defined MV.



Note

When in manual control mode, parameter settings can only be checked and cannot be modified (except for lock parameters).

When the unit is powered on following a power interruption or shutdown, the previous control mode (auto or manual) is maintained.

If switching to manual control during Auto-tuning, Auto-tuning is stopped. It is possible to switch to manual control mode while in STOP.

When sensor break alarm[5bA] occurs in standard control mode, the sensor error MV (E- \bar{A} U) is applied. In this state, manual and auto control MV settings can be modified.

It is still possible to switch auto/manual control mode while in controlling operation.

Operation priority: Manual Control > Stop > Open (sensor disconnection)

6.2.4.1 Manual/Auto Control Switching

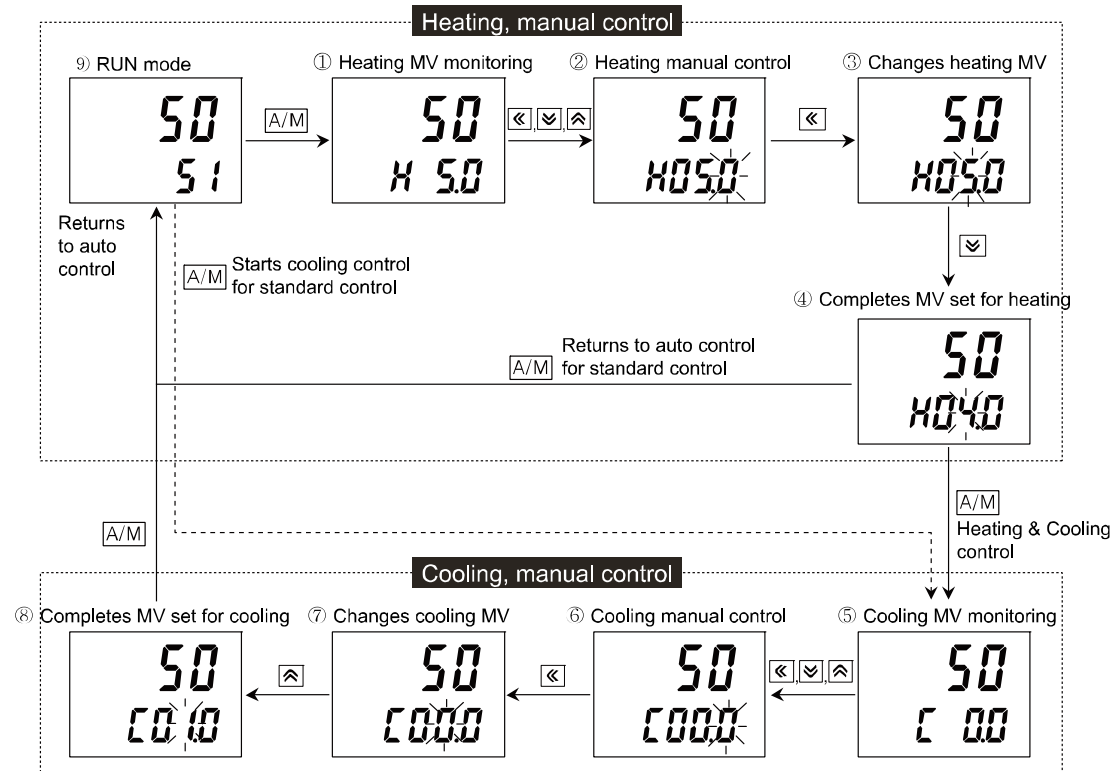







(1) In standard control(heating or cooling), manual control switching

- ①, ⑤: Press the **A/M** key once in RUN mode, it enters MV monitoring mode. The SV display part displays H (for heating control) or C (for cooling control) and the current MV.
- ②, ⑥: During monitoring MV, press any one of **←** **↓** **↑** keys, the last digit (10^0 Digit) flashes and it switches to manual control.
- ③, ⑦: Press the **←** key to change the flashing digit. (10^0 10^1 10^2 10^3 10^0)
- ④, ⑧: Press the **↓** **↑** key continuously, it moves as 0→1→2→3→4→5→6→7→8→9→0 and it is related with upper/lower digit. By **←** **↓** **↑** keys, set the desired MV.
- ⑨: Press the **A/M** in ① to ⑧ status, the MAN lamp turns OFF and the system returns to auto control mode.

(2) Heating & Cooling contro, manual control switching

- ①: Press the **A/M** key once in RUN mode, it enters heating MV monitoring mode. The SV display part displays H and the current heating MV.
- ②: During monitoring heating MV, press any one of **←** **↓** **↑** keys, the last digit (10^0 Digit) flashes and it switches to manual control.
- ③: Press the **←** key to change the flashing digit. (10^0 10^1 10^2 10^3 10^0)
- ④: Press the **↓** **↑** key continuously, it moves as 0→1→2→3→4→5→6→7→8→9→0 and it is related with upper/lower digit. By **←** **↓** **↑** keys, set the desired MV.
- ⑤: Press the **A/M** in ① to ⑧ status, it enters cooling MV monitoring mode. The SV display part displays C and the current cooling MV.
- ⑥: During monitoring cooling MV, press any one of **←** **↓** **↑** keys, the last digit (10^0 Digit) flashes.

- ⑦: Press the  key to change the flashing digit. (10^0 10^1 10^2 10^3 10^0)
- ⑧: Press the   key continuously, it moves as 0→1→2→3→4→5→6→7→8→9→0 and it is related with upper/lower digit.
By    keys, set the desired MV.
- ⑨: Press the  in ⑤ to ⑧ status, the MAN lamp turns OFF and the system returns to auto control mode.



Note

For heating and cooling control, the system returns to auto control after going through heating monitoring, manual heating control, cooling monitoring, and manual cooling control stages in sequence.

Heating MV remains in effect during cooling monitoring and manual cooling control.

When digital input terminal (DI-1, DI-2) function is set as AUTO/MANUAL, auto/manual control function by the front  key and communication does not operate.

(3) By digital input terminal (DI), auto/manual switching

When digital input terminal (DI) is set as AUTO/MANUAL, it switches to manual control when digital input terminal (DI) is ON(Close) (MAN lamp turns ON). It returns to auto control when digital input terminal (DI) is OFF(Open).

For auto control status of digital input terminal, only monitoring is available. For manual control status, monitoring and changing MV are available.



Note

For more information of digital input terminal (DI), refer to '6.7.4.1 Digital input terminal function [PR-5 di - 1/di - 2]".

6.2.4.2 Manual control, initial MV [PR5 → I.E.U]

When switching from auto control to manual control, you can select the initial MV at the switching point.

Auto_MV (R.U.O) : Controls with the auto control MV at the before-switching point as initial MV.

Pr.MV (Pr.M.U) : Controls with the set Pr.M.U (preset manual MV) value as initial MV.

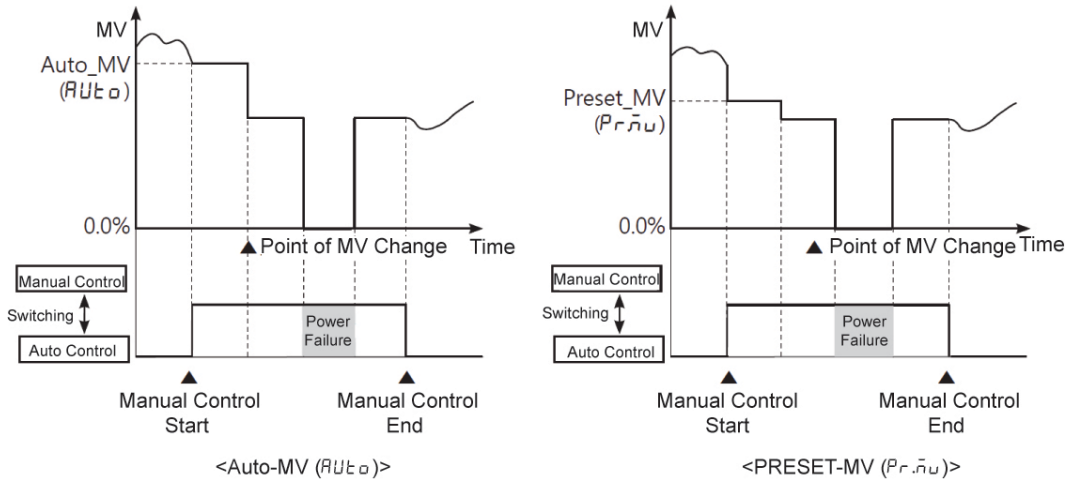

Setting group	Parameter	Set range	Factory default	Unit
PR5	I.E.U	R.U.O / Pr.M.U	R.U.O	-

6.2.4.3 Manual control, preset MV [PR5 → Pr.M.U]

For manual control, initial MV is set as Pr.M.U (preset manual MV), you can set the desired preset manual MV.

Setting group	Parameter	Set range		Factory default	Unit	
PR5	Pr.M.U	Standard control	ON/OFF control	000.0 (OFF) / 100.0 (ON)	000.0	%
			PID control	000.0 to 100.0		
		Heating & Cooling control	ON/OFF control	- 100.0 (cooling ON) / 000.0 (OFF) / 100.0 (heating ON)		
			PID control	- 100.0 (cooling) to 000.0 (OFF) to 100.0 (heating)		



Note

For heating & cooling control, when SV is within 0.1 to 100.0, it is applied to heating MV. When SV is within 0.1 to -100.0, it is applied to cooling MV.

6.2.5 Output type

6.2.5.1 Control output [$PAR3 \rightarrow OUT1$]

(1) 1-output model

This model supports relay output, current output, and SSR drive voltage output. You can select the desired one output type.

$OUT1$: Select control output of OUT1

Setting group	Parameter	Set range	Factory default	Unit
$PAR3$	$OUT1$	$RLY / SSR / CUR$	RLY	-

(2) 2-output model

No	Model	Control output	Factory default
1	KPN5□11- □□0	OUT1: Current, SSR drive voltage selection output	SSR
		OUT2: Current, SSR drive voltage selection output	SSR
2	KPN5□13- □□0	OUT1: Current, SSR drive voltage selection output	SSR
		OUT2: Relay output	RLY
3	KPN5□17- □□0	OUT1: Relay output	RLY
		OUT2: Current, SSR drive voltage selection output	SSR
4	KPN5□19- □□0	OUT1: Relay output	RLY
		OUT2: Relay output	RLY

6.2.5.2 Current output range [$PAR3 \rightarrow OL1R/OL2R$]

When control output is set as current output, high/low-limit of current output is selectable between 4-20mA or 0-20mA.

- $OL1R$: Current output range of OUT1
- $OL2R$: Current output range of OUT2



Note

When current output ($OUT1$, $OUT2$) is current output model, this parameter is displayed.

6.3 Temperature control

6.3.1 Temperature control type [PAR3 → [-nd]

You can select the desired control type to control temperature.

SV		Description	
		Heating	Cooling
Standard control	PID	PID control	
	ON/OFF	ON/OFF control	
Heating & Cooling control	P.P	PID control	PID control
	P.ON	PID control	ON/OFF control
	ON.P	ON/OFF control	PID control
	ON.ON	ON/OFF control	ON/OFF control

Setting group	Parameter	Set range		Factory default	Unit
PAR3	[-nd	Standard	PID / ON/OFF	PID	-
		Heating&Cooling	P.P / P.ON / ON.P / ON.ON	P.P	

6.3.2 ON/OFF control [PAR3 → [-nd → ON/OFF]

Controls the temperature by comparing PV (Present Value) with SV (Setting Value) and turning power to the load on or off.

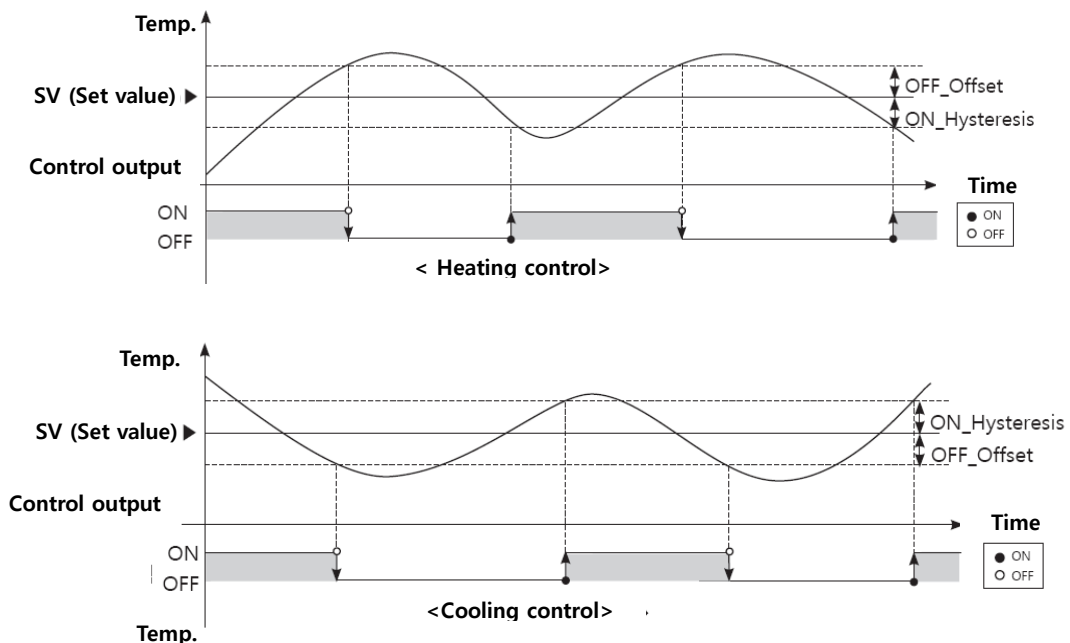

6.3.2.1 Hysteresis [*PAR-2* → *H.HYS/H.oFt/C.HYS/C.oFt*]

Hysteresis is to adjust control output ON/OFF point in ON/OFF control mode. ON_Hysteresis sets the output on point and OFF_Offset sets the off point.

Setting hysteresis too low can result in hunting induced by disturbance (noise, chattering, etc.). To minimize hunting, set ON_Hysteresis and OFF_Offset values with consideration to the heater or cooler's capacity and thermal characteristics, the control subject's response characteristics, the sensor's response characteristics and installation conditions, and other defining factors.

Parameter	Description
<i>H.HYS</i>	ON Hysteresis set for heating control
<i>H.oFt</i>	OFF_Offset set for heating control
<i>C.HYS</i>	ON Hysteresis set for cooling control
<i>C.oFt</i>	OFF_Offset set for cooling control

Setting group	Parameter	Set range	Factory default	Unit
<i>PAR-2</i>	<i>H.HYS</i>	Temperature H, analog: 00.1 to 100	002	°C/°F/-
	<i>C.HYS</i>	Temperature L: 00.1 to 10.0		
	<i>H.oFt</i>	Temperature H, analog: 00.1 to 100	000	
	<i>C.oFt</i>	Temperature L: 00.1 to 10.0		

6.3.3 PID control [PAR3 → [-nd → Pld]

PID control is a combination of proportional (P), integral (I), and derivative (D) controls and offers superb control over the control subjects, even with a delay time.

Proportional control (P) implements smooth, hunting-free control;
 Integral control (I) automatically corrects offsets;
 and Derivative control (D) speeds up the response to disturbance.

Through these actions, PID control realizes ideal temperature control.

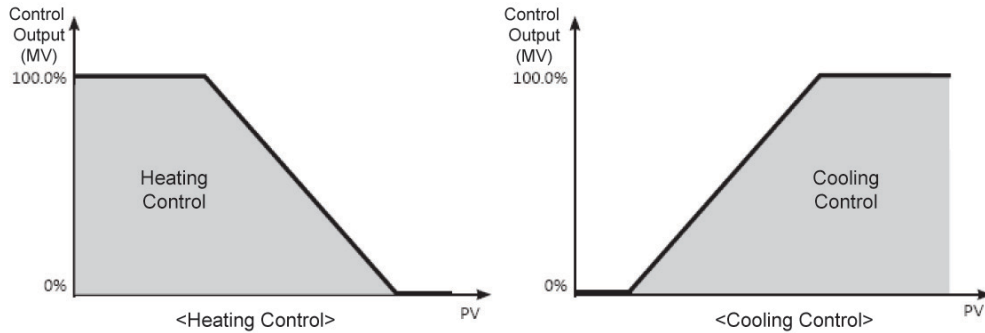

Note

Application of PID control

- Proportional (P) control: Select PID control and set integral time and derivative time to 0000.
- Proportional Integral (PI) control: Select PID control and set derivative time to 0000.
- Proportional Derivative (PD) control: Select PID control and set integral time to 0000.

When using multi-SV function, PID time constants for Svd to Svd are applied same.

6.3.3.1 Proportional band [PAR2 → H-P / [-P]

When PV (Present Value) is within the Proportional Band (P), the ON/OFF ratio needs to be adjusted during the proportional period (T). The defined proportional control (time proportional control) section is called as the proportional band.

Parameter	Description
H-P	Proportioanl band for heating
[-P	Proportioanl band for cooling

Setting group	Parameter	Set range	Factory default	Unit
PAR2	H-P	000.1 to 999.9	0 10.0	Temp.: °C/°F Analog: %
	[-P			

6.3.3.2 Integral time [PR-2 → H-1 / C-1]

MVs from integral and proportional operation become the same when deviation is consistent. The time taken for the two MVs to match is called the integral time.

Parameter	Description
H-1	Integral time for heating
C-1	Integral time for cooling

Setting group	Parameter	Set range	Factory default	Unit
PR-2	H-1	0000 to 9999	0000	sec.
	C-1			

**Note**

Integral control is not conducted if the integral time is set to 0. Setting the integral time too short can intensify Correction Movements and cause hunting.

6.3.3.3 Derivative time [PR-2 → H-d / C-d]

In accordance with the deviation of the ramp, the time taken for the MV gained from derivative operation to reach the MV gained from proportional control is called the derivative time.

Parameter	Description
H-d	Derivative time for heating
C-d	Derivative time for cooling

Setting group	Parameter	Set range	Factory default	Unit
PR-2	H-d	0000 to 9999	0000	sec.
	C-d			

**Note**

Derivative control is not conducted if the derivative time is set to 0. When using multi-SV function, PID time constants for S_{U0} to S_{U3} are applied same.

6.3.3.4 Control time [$PAR3 \rightarrow H-t / C-t$]

If relay or SSR is used to output MV under proportional control, the output is on for a fixed amount of time (within the control period, as a percentage of the MV) and then remains off for the rest of the time. The preset period when output ON/OFF takes place is called the proportional control period.

Control with SSR drive voltage output has a faster response than that of relay output. Therefore, by configuring a shorter control period, more responsive temperature control is achieved.

Parameter	Description
$H-t$	Control time for heating
$C-t$	Control time for cooling

Setting group	Parameter	Set range	Factory default	Unit
$PAR3$	$H-t$	00.1 to 120.0	Relay output: 020.0	sec.
	$C-t$		SSR drive voltage output: 002.0	



Note

For heating & cooling control, set the control time for heating and the control time for cooling individually.

6.3.3.5 Offset correction/manual reset [$PAR2 \rightarrow rES\%$]

When selecting P / PD control mode, there are certain temperature differences even after PV reaches stable status since heater's rising and falling time is inconsistent due to thermal characteristics of control objects, such as heat capacity and the heater capacity. This temperature difference is called OFFSET. Offset can be corrected using manual reset.

Setting group	Parameter	Set range	Factory default	Unit
$PAR2$	$rES\%$	000.0 to 100.0	050.0	%

- Manual reset adjustment based on control result
Under stable control conditions, set the offset to 50% if PV and SV are identical, to over 50.0% if PV is lower than SV, and to below 50.0% if PV is higher than SV.

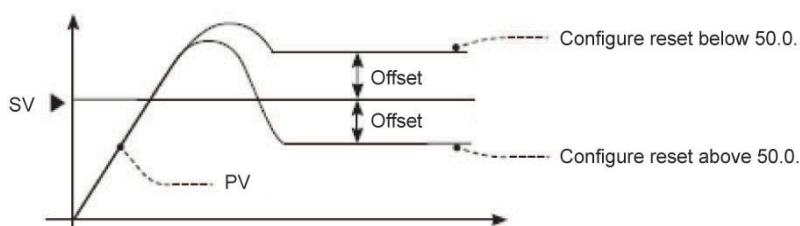

Note

The offset correction feature can only be used when proportional control is in effect. If setting the integral value to 0, the manual reset parameter is displayed.

The user cannot configure the manual reset setting during heating and cooling control. Instead, the setting is automatically set to 0% for both heating and cooling.

Applicable only when integral time is set to 0 (under P control or PD control only).

Switching from heating and cooling control to standard control (P, PD control) automatically configures the reset setting to 50%.

6.3.4 Auto-tuning

Auto-tuning measures the control subject's thermal characteristics and thermal response rate, and calculates and set the PID time constant for fast response characteristics and high stability. (Set control type [$C - \bar{n}d$] as PID)

It stops the progress automatically when error [σPE_n] occurs during operating auto-tuning. To stop auto-tuning, set as [σFF].

(Maintains the before P, I, D value before executing auto-tuning)

6.3.4.1 Auto-tuning RUN/STOP [$PRr2 \rightarrow Rt$]

Auto-tuning automatically stores PID time constants upon termination. These PID time constants can then be modified by the user to suit their usage environment.

When auto-tuning is in progress, the AT lamp located on the front of the controller flashes in 1-second intervals. When auto-tuning finishes, the AT lamp automatically goes off and the auto-tuning parameter will return to σFF .

When auto-tuning is in progress and digital input [$dl - 1, dl - 2$] feature is RUN/STOP or AUTO/MANUAL, auto-tuning will be automatically ended, if concerned digital input is inputted or a sensor disconnection error occurs. (Restored the PID used prior to the auto-tuning session)

Set value	Description
σFF	Auto-tuning OFF
σn	Auto-tuning ON

Setting group	Parameter	Set range	Factory default	Unit
$PRr2$	Rt	$\sigma FF / \sigma n$	σFF	-



Note

- Auto-tuning continues to run even if the temperature reading exceeds or falls below the input range.
- When auto-tuning is in progress, parameters can only be referenced and not changed.
- Auto-tuning is not available in manual control.

6.3.4.2 Auto-tuning mode [PAR3 → ALE]]

Auto-tuning is available in Tun1 MODE (SV) or Tun2 MODE (70% of SV), depending on the baseline value used.

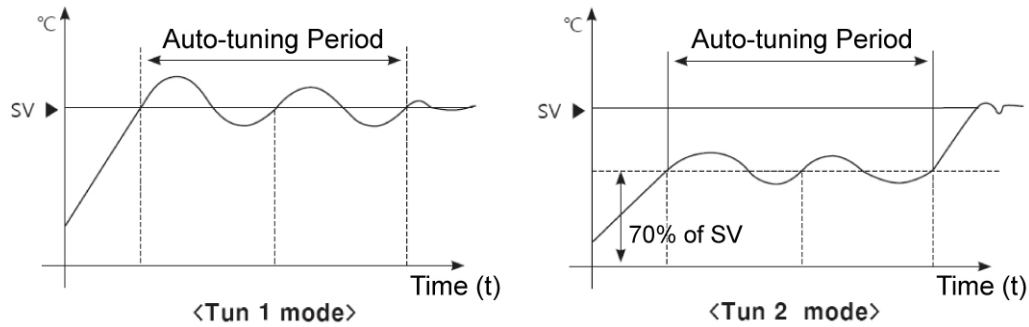

Set value	Description
$tUn1$	Tun1 mode: Auto-tuning and calculates the PID time constant based on SV (set value).
$tUn2$	Tun2 mode: Auto-tuning and calculates the PID time constant based on 70% of SV (set value).

Setting group	Parameter	Set range	Factory default	Unit
PAR3	ALE	$tUn1 / tUn2$	$tUn1$	-



Note

In cooling control mode, TUN2 Mode calculates 70% based at 0°C.
When SV=-100°C, TUN2 is performed at -70°C.

6.4 Alarm

This product has 3 alarms to operate individually when the value is too high or low. Alarm function is set by the combination of alarm mode and alarm option. To clear alarm, use digital input function (setting as *RL - E*) or turn the power OFF and ON.

6.4.1 Alarm operation [*PAR 4* → *AL - 1/AL - 2/AL - 3*]

You can set the alarm operation.

Mode	Name	Operation	Description
<i>OFF</i>	-	-	No alarm output
<i>duCC</i>	Deviation high-limit alarm	<p>High deviation: Set as 10°C</p> <p>High deviation: Set as -10°C</p>	If deviation between PV and SV as high-limit is higher than set value of deviation temperature, the alarm output will be ON. Set deviation high-limit at <i>AL 1.H/AL 2.H/AL 3.H</i> .
<i>]]du</i>	Deviation low-limit alarm	<p>Low deviation: Set as 10°C</p> <p>Low deviation: Set as -10°C</p>	If deviation between PV and SV as low-limit is higher than set value of deviation temperature, the alarm output will be ON. Set deviation low-temperature at <i>AL 1.L/AL 2.L/AL 3.L</i> .
<i>]]duC</i>	Deviation high/low-limit alarm	<p>Low deviation: Set as 10°C</p> <p>High deviation: Set as 20°C</p>	If deviation between PV and SV as high/low-limit is higher than set value of deviation temperature, the alarm output will be ON. Set deviation high-limit at <i>AL 1.H/AL 2.H/AL 3.H</i> . Set deviation low-temperature at <i>AL 1.L/AL 2.L/AL 3.L</i> .
<i>[du]</i>	Deviation high/low-limit reverse alarm	<p>Low deviation: Set as 10°C</p> <p>High deviation: Set as 20°C</p>	If deviation between PV and SV as high/low-limit is higher than set value of deviation temperature, the alarm output will be OFF. Set deviation high-limit at <i>AL 1.H/AL 2.H/AL 3.H</i> . Set deviation low-temperature at <i>AL 1.L/AL 2.L/AL 3.L</i> .
<i>PuCC</i>	Absolute value high-limit alarm	<p>Absolute value: Set as 90°C</p> <p>Absolute value: Set as 110°C</p>	If PV is equal as or higher than the absolute value, the output will be ON. Set absolute high-limit at <i>AL 1.H/AL 2.H/AL 3.H</i> .
<i>]]Pu</i>	Absolute value low-limit alarm	<p>Absolute value: Set as 90°C</p> <p>Absolute value: Set as 110°C</p>	If PV is equal as or lower than the absolute value, the output will be ON. Set absolute low-limit at <i>AL 1.L/AL 2.L/AL 3.L</i> .

Mode	Name	Operation	Description
LbA	Loop break alarm	-	It will be ON when it detects loop break.
SbA	Sensor break alarm	-	It will be ON when it detect sensor disconnection.
HbA	Heater break alarm	-	It will be ON when CT detects heater break.

※H: Alarm output hysteresis [A□.HY]

Parameter	Description
AL-1	Select alarm 1 mode
AL-2	Select alarm 2 mode
AL-3	Select alarm 3 mode

Setting group	Parameter	Set range	Factory default	Unit
PAR-4	AL-1	OFF / duCC / JJdu / JduC / CduJ / PuCC / JJPu / SbA / LbA / HbA	duCC	-
	AL-2		JJdu	-
	AL-3		LbA	

6.4.2 Alarm option [PAR-4 → AL 1E / AL 2E / AL 3E]

Users can select the desired alarm output options.

Set value	Option	Description
AL-A	Standard Alarm	If it is an alarm condition, alarm output is ON. If it is a clear alarm condition, alarm output is OFF.
AL-b	Alarm latch ※ ¹	If it is an alarm condition, alarm output is ON and maintains ON status. (alarm output HOLD)
AL-C	Standby sequence1 ※ ²	First alarm condition is ignored and from second alarm condition, standard alarm operates. When power is supplied and it is an alarm condition, this first alarm condition is ignored and from the second alarm condition, standard alarm operates.
AL-d	Alarm latch and standby sequence1	If it is an alarm condition, it operates both alarm latch and standby sequence. When power is supplied and it is an alarm condition, this first alarm condition is ignored and from the second alarm condition, alarm latch operates.
AL-E	Standby sequence2	First alarm condition is ignored and from second alarm condition, standard alarm operates. When re-supplied standby sequence and if it is alarm condition, alarm output does not turn ON. After clearing alarm condition, standard alarm operates.
AL-F	Alarm latch and standby sequence2	Basic operation is same as alarm latch and standby sequence 1. It operates not only by power ON/OFF, but also alarm setting value, or alarm option changing. When re-applied standby sequence and if it is alarm condition, alarm output does not turn ON. After clearing alarm condition, alarm latch operates.

- Condition of re-applied standby sequence for standby sequence 1, alarm latch and standby sequence 1: Powr ON

- Condition of re-applied standby sequence for standby sequence 2, alarm latch and standby sequence 2: Power ON, changing set temperature, alarm temperature (AL1, AL2, AL3) or alarm operation (AL-1, AL-2, AL-3), switching STOP mode to RUN mode

Parameter	Description
<i>AL 1.t</i>	Select alarm 1 option
<i>AL 2.t</i>	Select alarm 2 option
<i>AL 3.t</i>	Select alarm 3 option

Setting group	Parameter	Set range	Factory default	Unit
<i>PAR 4</i>	<i>AL 1.t</i>	<i>AL - A / AL - b / AL - C / AL - d / AL - E / AL - F</i>	<i>AL - A</i>	-
	<i>AL 2.t</i>			-
	<i>AL 3.t</i>			



Note

When selecting alarm output mode as *LbA*, *SbA*, *HbA* *AL - C*, *AL - d* options are not displayed.

6.4.3 Alarm output set value [*PAR 1* → *AL 1.L / AL 1.H / AL 2.L / AL 2.H / AL 3.L / AL 3.H*]

You can set alarm output activation values. According to the selected alarm output mode, configuration parameters [*AL .H / AL .L*] will be activated for each setting.

Parameter	Description
<i>AL 1.L</i>	Low limit value of alarm output 1. Reference value for determining heater break
<i>AL 1.H</i>	High-limit value of alarm output 1.
<i>AL 2.L</i>	Low limit value of alarm output 2. Reference value for determining heater break.
<i>AL 2.H</i>	High-limit value of alarm output 2.
<i>AL 3.L</i>	Low limit value of alarm output 3. Reference value for determining heater break.
<i>AL 3.H</i>	High-limit value of alarm output 3.

Setting group	Parameter	Set range	Factory default	Unit
<i>PAR 1</i>	<i>AL 1.H</i>	- (temperature) high/low deviation: -F.S. to F.S. by each input type	Temperature : <i>1550</i> Analog : <i>100.0</i>	-
	<i>AL 2.H</i>			
	<i>AL 3.H</i>			
	<i>AL 1.L</i>	- (analog) high/low deviation value: - <i>1999</i> to <i>9999</i> within -F.S. to F.S.		
	<i>AL 2.L</i>			
	<i>AL 3.L</i>			



Note

Changing the alarm output mode or options resets the settings to the highest or lowest values that will not trigger output in the new mode.

6.4.4 Alarm output hysteresis [PAR4 → A1.HY/A2.HY/A3.HY]

- 'H' of operation group of '6.4.1 Alarm operation [PAR4 AL-1/AL-2/AL-3]' is alarm output hysteresis. You can set the interval between ON and OFF of alarm output.
- You can select it (Alarm1 Hysteresis/ Alarm2 Hysteresis/ Alarm3 Hysteresis) by each alarm.

Parameter	Description
A1.HY	Set interval between ON and OFF of alarm output 1
A2.HY	Set interval between ON and OFF of alarm output 2
A3.HY	Set interval between ON and OFF of alarm output 3

Setting group	Parameter	Set range	Factory default	Unit
PAR4	A1.HY	Temperature H, analog: 00.1 to 100	00.1	Temperature: °C/°F, Analog: Digit
	A2.HY			
	A3.HY	Temperature L: 000.1 to 100.0		



Note

Alarm output hysteresis is also applied as same during heater break alarm [HbA].

When alarm mode is loop break alarm [LbA] or sensor break alarm [SbA], this parameter is not displayed.

6.4.5 Alarm output contact type [PAR4 → A1.n/A2.n/A3.n]

You can set relay contact type for alarm output.

Set value	Description
no	Normally Open: Stays open when normal and closes in the event of an alarm.
nC	Normally Closed: Stays closed when normal and opens in the event of an alarm.

Parameter	Description
A1.n	Select contact type for alarm output 1
A2.n	Select contact type for alarm output 2
A3.n	Select contact type for alarm output 3

Setting group	Parameter	Set range	Factory default	Unit
PAR4	A1.n	no / nC	no	-
	A2.n			
	A3.n			

Front indicator operations

Set value	Alarm	Alarm output	Front indicators
no (Normally Open)	OFF	Open	<input type="checkbox"/> OFF
	ON	Close	<input checked="" type="checkbox"/> ON
nC (Normally Closed)	OFF	Close	<input type="checkbox"/> OFF
	ON	Open	<input checked="" type="checkbox"/> ON

6.4.6 Alarm output dealy time [PR4 → R1.oN/R1.oF/R2.oN/R2.oF/R3.oN/R3.oF]

Alarm output delay can be set to prevent false alarms caused by erroneous input signals resulting from disturbances or noise.

With a preset delay time, alarm output does not turn on for the preset duration. Instead, the concerned alarm indicator on the front flashes in 0.5-second intervals.

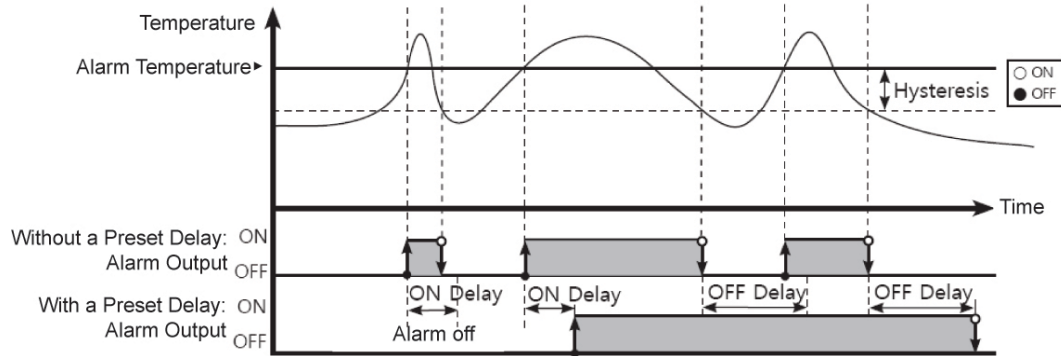

Parameter	Description
R1.oN	Alarm Output 1 On Delay: Stands by for the preset duration upon an alarm event, checks the alarm trigger conditions, and turns on the alarm output if the conditions are still present.
R1.oF	Alarm Output 1 Off Delay. Stands by for the preset duration following alarm output off, checks the alarm trigger conditions, and turns off the alarm output if the clear conditions are still present.
R2.oN	Alarm Output 2 On Delay. Stands by for the preset duration upon an alarm event, checks the alarm trigger conditions, and turns on the alarm output if the conditions are still present.
R2.oF	Alarm Output 2 Off Delay. Stands by for the preset duration following alarm output off, checks the alarm trigger conditions, and turns off the alarm output if the clear conditions are still present.
R3.oN	Alarm Output 3 On Delay. Stands by for the preset duration upon an alarm event, checks the alarm trigger conditions, and turns on the alarm output if the conditions are still present.
R3.oF	Alarm Output 3 Off Delay. Stands by for the preset duration following alarm output off, checks the alarm trigger conditions, and turns off the alarm output if the clear conditions are still present.

Setting group	Parameter	Set range	Factory default	Unit
PR4	R1.oN	0000 to 3600	0000	sec.
	R1.oF		0000	sec.
	R2.oN		0000	sec.
	R2.oF		0000	sec.
	R3.oN		0000	sec.
	R3.oF		0000	sec.

6.4.7 Loop break alarm (LBA) [$PR_4 \rightarrow RL-1/RL-2/RL-3 \rightarrow LbA$]

Diagnoses the control loop by monitoring the control subject's temperature changes and sends out alarms if necessary.

- Heating control: When control output MV is 100% or high limit [$H-\bar{n}_u$] and PV is not increased over than LBA detection band [$LbA.b$] during LBA monitoring time [$LbA.t$], or when control output MV is 0% or low limit [$L-\bar{n}_u$] and PV is not decreased below than LBA detection band [$LbA.b$] during LBA monitoring time [$LbA.t$], alarm output turns ON.
- Cooling control: When control output MV is 0% or low limit [$L-\bar{n}_u$] and PV is not increased over than LBA detection band [$LbA.b$] during LBA monitoring time [$LbA.t$], or when control output MV is 100% or high limit [$H-\bar{n}_u$] and PV is not decreased below than LBA detection band [$LbA.b$] during LBA monitoring time [$LbA.t$], alarm output turns ON.

Main causes of LBA output ON

- Sensor error (disconnection, short)
- External controller error (magnet, auxiliary relay, etc)
- External load error (heater, cooler, etc)
- Wrong connection and disconnection of external devices



Note

Set alarm output mode [$RL-\square$] as loop break alarm [LbA] and you can use loop break alarm.

When executing auto-tuning, LBA detection band [$LbA.b$] and LBA monitoring time [$LbA.t$] are automatically set by auto-tuning value.

In case of AT (auto-tuning)/manual control/stop control, loop break alarm [LbA] does not operate. When alarm reset is input, it initializes LBA monitoring start time.

6.4.7.1 LBA monitoring time [$PR_4 \rightarrow LbA.t$]

You can set the LBA monitoring time to check changes in the control subject's temperature. It is set automatically when executing Auto-tuning.

Setting group	Parameter	Set range	Factory default	Unit
PR_4	$LbA.t$	0000 to 9999	0000	sec.

6.4.7.2 LBA detection band [PAR4 → LbA.b]

You can set the minimum value of deviation change to decrease during LBA monitoring time. It is set automatically when executing Auto-tuning.

Setting group	Parameter	Set range	Factory default	Unit
PAR4	LbA.b	Temperature H	000 to 999	003 °C/°F
		Temperature L	000.0 to 999.9	003.0 °C/°F
		Analog	00.00 to 99.99	00.20 %FS



Ex.

For heating control(cooling control), when control output MV is 100%(0% for cooling control) and PV is not increased over than LBA detection band [LbA.b] during LBA monitoring time [LbA.t], or when control output MV is 0%(100% for cooling control) and PV is not decreased below than LBA detection band [LbA.b] during LBA monitoring time [LbA.t], alarm output turns ON.

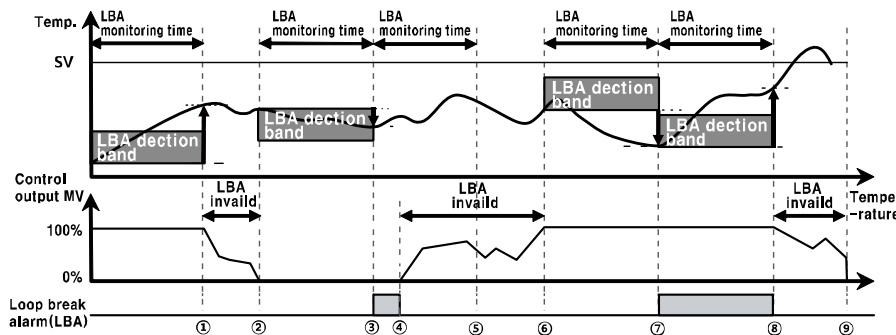

Start to control to ①	When control output MV is 100%, PV is increased over than LBA detection band [LbA.b] during LBA monitoring time [LbA.t].
① to ②	The status of changing control output MV (LBA monitoring time is reset.)
② to ③	When control output MV is 0% and PV is not decreased below than LBA detection band [LbA.b] during LBA monitoring time [LbA.t], loop break alarm (LBA) turns ON after LBA monitoring time.
③ to ④	Control output MV is 0% and loop break alarm (LBA) turns and maintains ON.
④ to ⑥	The status of changing control output MV (LBA monitoring time is reset.)
⑥ to ⑦	When control output MV is 100% and PV is not increased over than LBA detection band [LbA.b] during LBA monitoring time [LbA.t], loop break alarm (LBA) turns ON after LBA monitoring time.
⑦ to ⑧	When control output MV is 100% and PV is increased over than LBA detection band [LbA.b] during LBA monitoring time [LbA.t], loop break alarm (LBA) turns OFF after LBA monitoring time.
⑧ to ⑨	The status of changing control output MV (LBA monitoring time is reset.)

6.4.8 Sensor break alarm [PAR 4 → AL - 1/AL - 2/AL - 3 → 5bA]

You can set the controller to send out an alarm when a sensor is not connected or disconnected during temperature control. Sensor break can be confirmed through an external alarm output contact, such as a buzzer or similar devices.

Set alarm output mode [AL - □] as 5bA, sensor break alarm operates.



Note

Alarm output option can be set to standard alarm [AL - A] or alarm latch [AL - b].

6.4.9 Heater break alarm [PAR 4 → AL - 1/AL - 2/AL - 3 → HbA]

When using a heater to raise the temperature of the control subject, the temperature controller can be set to detect heater disconnection and send out an alarm by monitoring power supply to the heater.

Heater disconnection is detected by the controller using a current transformer (CT), which converts the current to the heater to a specific ratio (CT ratio) for monitoring. If the heater current value [CT - A] measured by the C.T. is less than the heater detection setting value [AL □ - L], the heater break alarm operates.

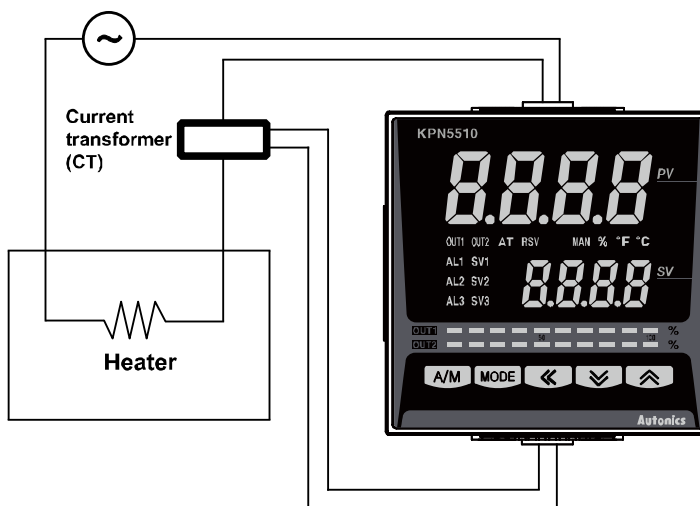

Note

- Heater break detection only takes place when the temperature controller's output is turned on. Otherwise, heater burnout will not be detected by the controller.
- Detection is only available in models with switching output (Relay contact output, SSR standard drive output). Models with linear output (current, SSR cycle/phase output) cannot detect.
- Current detection is not performed if OUT1's control output time is less than 250 ms.
- It is recommended to use the current transformer (CSTC-E80LN, CSTC-E200LN, sold separately).
- You can select the alarm option between standard alarm [AL - A] or alarm latch [AL - b].

6.4.9.1 Heater break detection value [PAR 1 → AL 1.L / AL 2.L / AL 2.L]

Set the alarm output value [AL □.L] as the reference value for heater burnout detection.

Setting group	Parameter	Set range	Factory default	Unit
PAR 1	AL 1.L	00.0 to 50.0	00.0	A
	AL 2.L			
	AL 3.L			



Note

Set to 00.0 for OFF. Set to 50.0 for ON.



Ex.

Heater break set value = {(Normal heater current) + (Heater break current)}/2

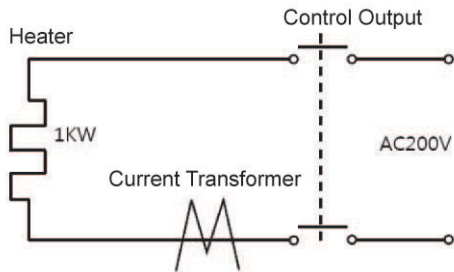

If using a single output heater (capacity: 200 VAC, 1 KW, 5 A), normal heater current is 5 A, and burnout heater current is 0 A, the setting value is calculated as $(5 \text{ A} + 0 \text{ A}) / 2 = 2.5 \text{ A}$. Therefore, heater current values less than 2.5 A will be deemed heater burnout and the alarm will activate.

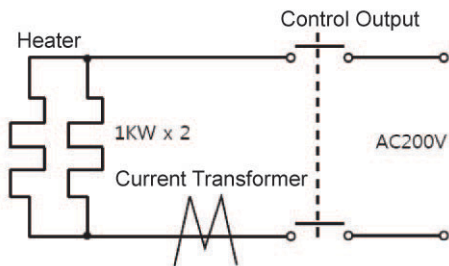

When two output heaters (capacity: 200 VAC, 1 KW, 5 A) are used, normal heater current is 10 A (5 A X 2 EA). If a single heater burns out, the heater current becomes 5 A. The setting value is calculated as $(10 \text{ A} + 5 \text{ A}) / 2 = 7.5 \text{ A}$. Heater current values of less than 7.5 A are deemed heater burnout and the alarm activates.

6.4.10 Alarm output clear [PAR5 → DI - 1 → AL .rE]

Available only if alarm output option is set to alarm latch or alarm latch and standby sequence1, alarm latch and standby sequence2. It can be set to turn off alarm output when alarm output is on, alarm output conditions have been removed, or an alarm output clear signal that is greater than the minimal signal band is received. (However, alarm output clear is unavailable when alarm conditions remain in effect.)

You can assign the front panel's digital input key or the digital input terminals (DI-1, DI-2) for the alarm output deactivation feature.

(1) Clear alarm output by digital input key

If the digital input key has been assigned for alarm output deactivation and the alarm output option is set to alarm latch or alarm latch and standby sequence, press and hold the front and keys when alarm output is on.

(2) Clear alarm output by digital input terminal (DI)

When the digital input (DI) terminal is assigned to forced alarm (output) off, the alarm output clears when digital input (DI) terminal goes into the on state (close). (MAN lamp on).



Note

For more information of digital input key, refer to '6.7.4.2 Digital input key'.

For more information of digital input terminal(DI), refer to '6.7.4.1 Digital input terminal function [PAR5 DI - 1/DI - 2]'.

After clearing alarm output, alarm output operates normally at the next alarm output ON.

6.4.11 Alarm output operation

6.4.11.1 Absolute value high-limit alarm and deviation high-limit alarm

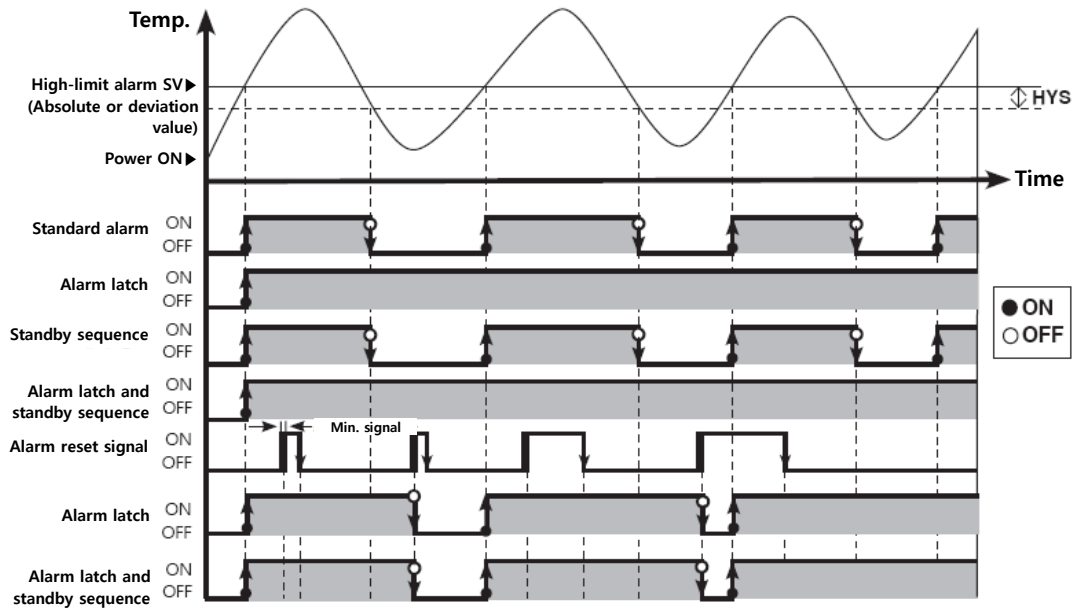

6.4.11.2 Absolute value low-limit alarm and deviation low-limit alarm

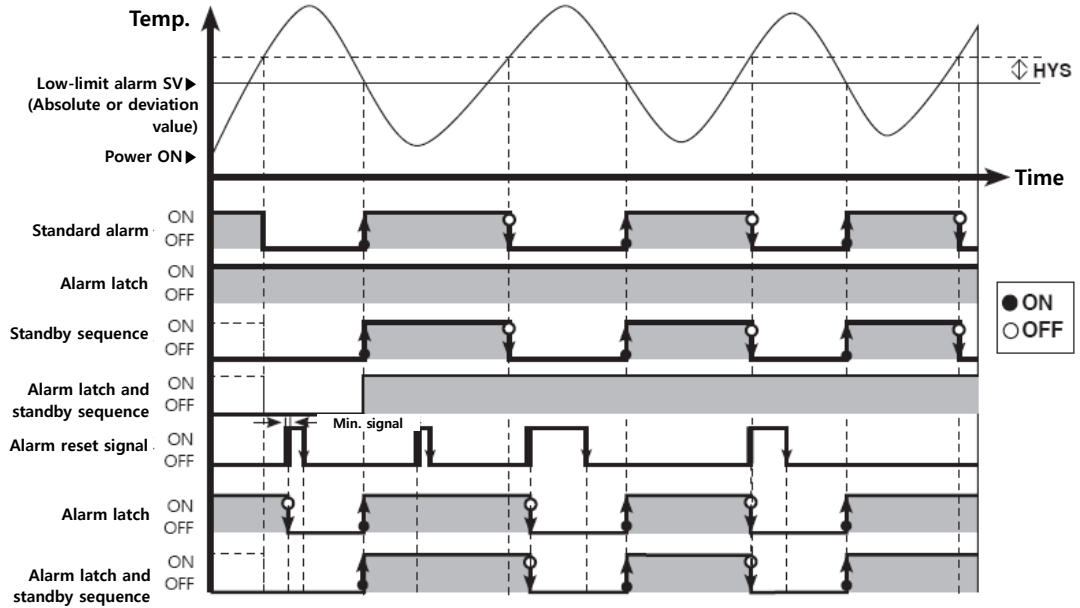

6.4.11.3 Deviation high/low-limit alarm

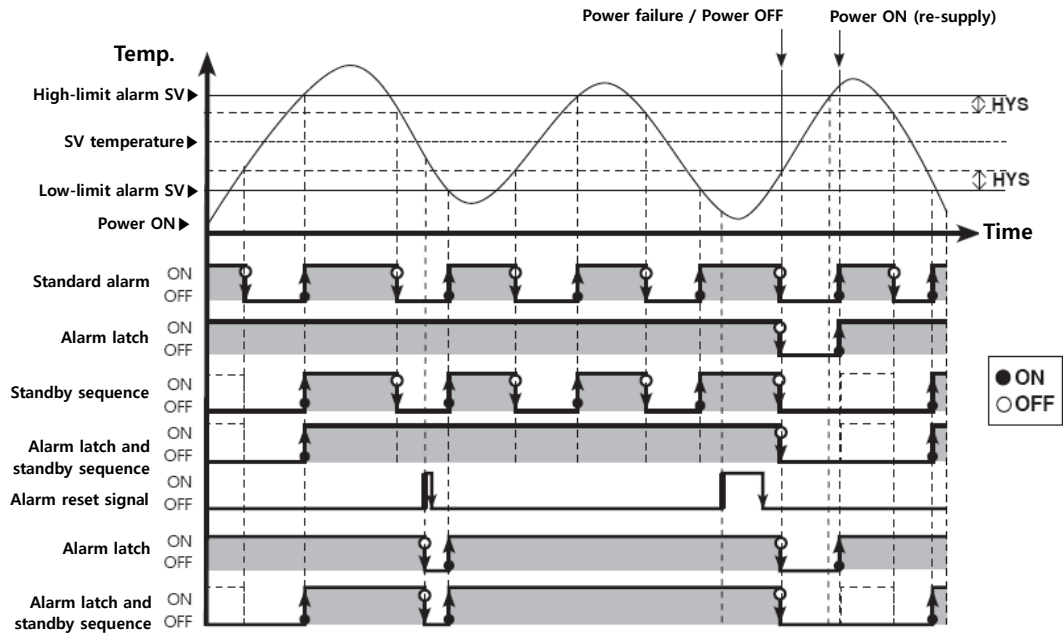

6.4.11.4 Deviation high/low-limit reverse alarm

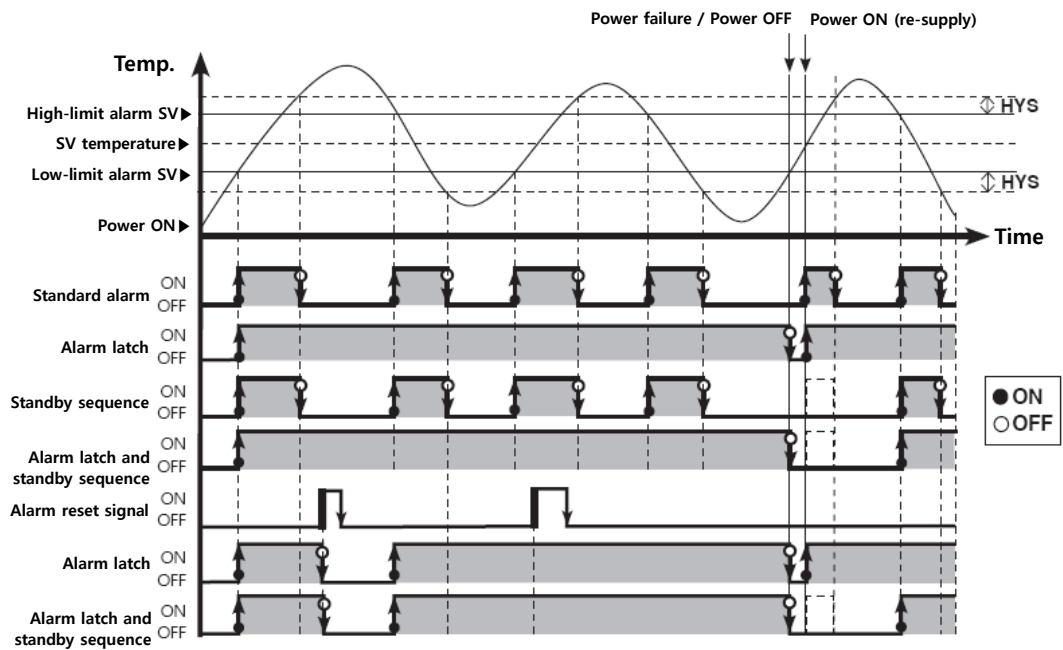

6.4.11.5 Deviation high/low-limit alarm (hysteresis overlap)

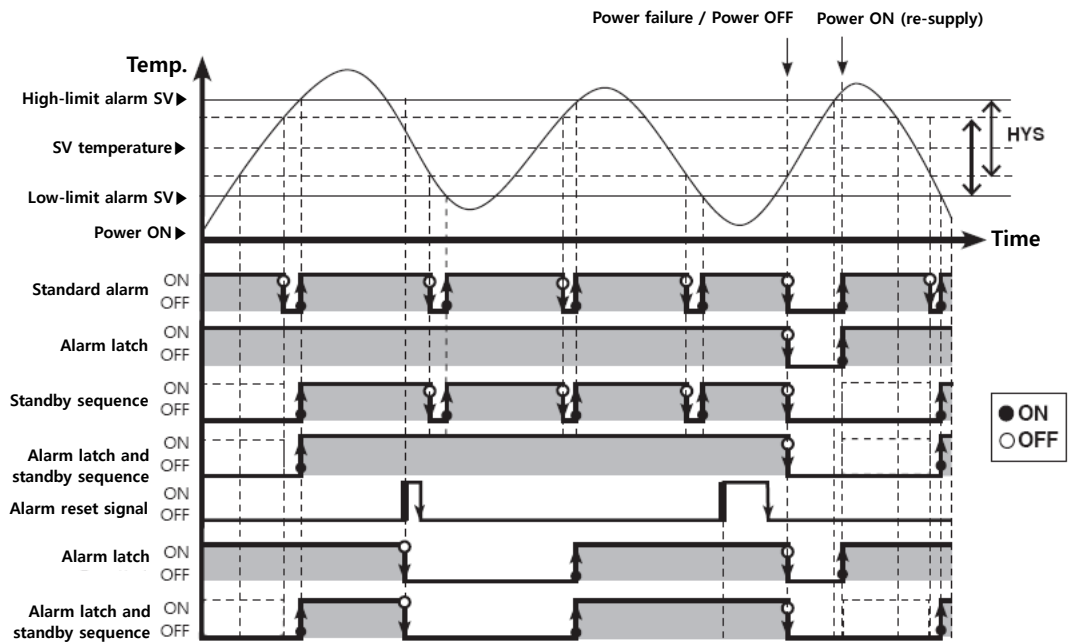

6.5 Analog transmission

6.5.1 Analog transmission output value [$PR4 \rightarrow AO-n$]

Transmission output is a type of auxiliary output that converts the controller's PV, SV, H-MV, and C-MV to analog current (DC 4 to 20 mA) for external transmission.

Set value	Description
P_u	PV transmission output
S_u	SV transmission output
$H-n_u$	Heating MV transmission output
$C-n_u$	Cooling MV transmission output

Setting group	Parameter	Set range	Factory default	Unit
$PR4$	$AO-n$	$P_u / S_u / H-n_u / C-n_u$	P_u	-



Note

This parameter is displayed in transmission output models only.

Transmission output is constant current output. Too great a resistance from the load can cause the output value to change. There is no optional output below 4 mA or above 20 mA.

6.5.2 Transmission output high/low-limit value [$PR4 \rightarrow F5-L / F5-H$]

If the transmission output value ($AO-n$) is below the transmission output lower limit ($F5-L$), 4 mA output will be provided. If the transmission output is between the lower limit ($F5-L$) and upper limit ($F5-H$), a certain proportional output within the range 4 mA and 20 mA will be provided. If it is above the upper limit ($F5-H$), 20 mA output will be provided.

Set value	Description
$F5-L$	Transmission output (4mA) low-limit value setting
$F5-H$	Transmission output (20mA) high-limit value setting

Setting group	Parameter	Set range	Factory default	Unit	
$PR4$	$F5-L$	P_u	Temperature: temperature range Analog: High/Low scale range	-200	Digit
		S_u	SV low-limit value [$L-S_u$] to SV high-limit value [$H-S_u$]		
		$H-n_u / C-n_u$	000.0 to 100.0		
	$F5-H$	P_u	Temperature: temperature range Analog: High/Low scale range	1350	
		S_u	SV low-limit value [$L-S_u$] to SV high-limit value [$H-S_u$]		
		$H-n_u / C-n_u$	000.0 to 100.0		



Note

If transmission output high limit (F5-H) is transmission output low limit (F5-L), the transmission output is 4 mA.

(1) Present value (PV) transmission output

PV within sensor range or high/low limit scale can be converted and transmitted as current within the range of 4 mA and 20 mA.

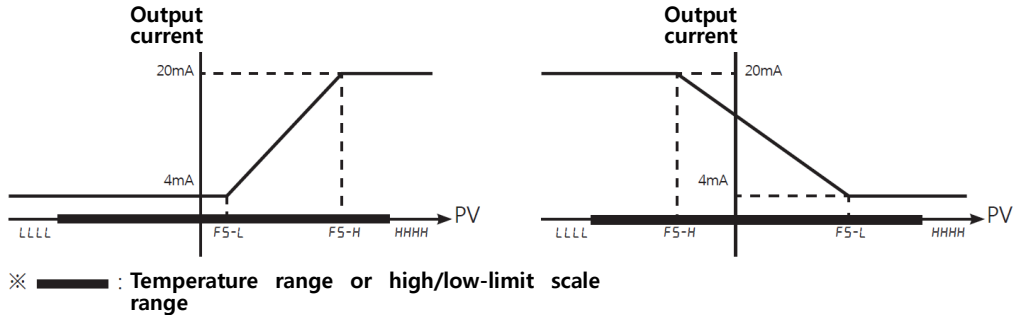

(2) Set value(SV) transmission output

SV within sensor range or high/low limit scale can be converted and transmitted as current within the range of 4 mA and 20 mA. When ramp is in effect, ramp SV is transmitted step by step.

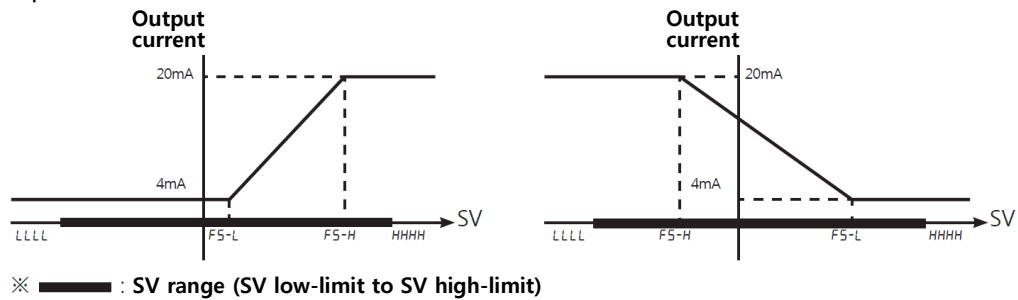

(3) Heating MV/Cooling MV transmission output

You can convert 0 to 100% of heating [H- \bar{n} U]/cooling MV [\bar{L} - \bar{n} U] into 4 to 20 mA current.

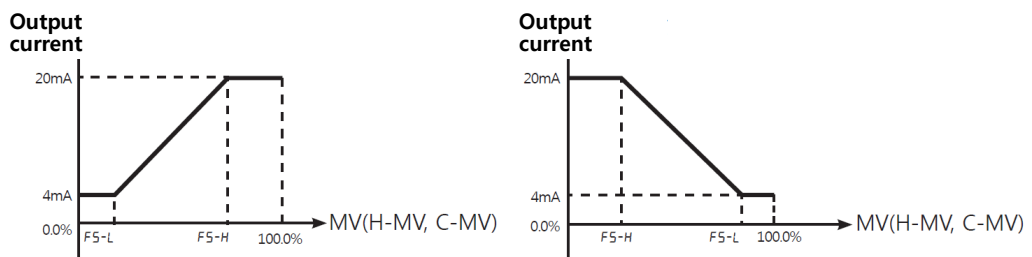

6.6 Communication

This feature is used for external higher systems (PC, GP, etc.) to set the controller's parameters and to monitor the controller. It can also be used to transmit data to external devices.

No redundant unit addresses may exist along the same communication line. The communication cable must be twisted pair that supports RS485.

- Interface

Item	Description
Standard	Compliance with EIA RS485
Max. connections	31 units (address: 01 to 127)
Communication method	2-wire half duplex
Synchronization method	Asynchronous
Communication distance	Within max. 800m
Communication speed	2400, 4800, 9600, 19200, 38400 bps
Response wait time	5 to 99ms
Start bit	1bit (fixed)
Data bit	8bit (fixed)
Parity bit	None, Even, Odd
Stop bit	1, 2bit
Protocol	Modbus RTU (Character = 11Bit as fixed)



Note

You could modify the parameter (first in, first out) using keys during communication connection, but this may lead to errors and malfunctions.

6.6.1 Communication address [*PAR 4* → *ADR 5*]

Set the address for data communication.

Setting group	Parameter	Set range	Factory default	Unit
<i>PAR 4</i>	<i>ADR 5</i>	01 to 127	01	-

6.6.2 Communication speed [*PAR 4* → *BP5*]

Set the transmission speed (bps) for data communication.

Setting group	Parameter	Set range	Factory default	Unit
<i>PAR 4</i>	<i>BP5</i>	24(2400bps) / 48(4800bps) / 96(9600bps) / 192(19200bps) / 384(38400bps)	96	bps

6.6.3 Communication parity bit [*PAR4* → *PRTY*]

Parity bit is a data communication method that adds one additional bit to each character in transmitted data as an indicator used to verify data loss and corruption. This parameter is used to enable or disable the parity bit option.

Set value	Description
<i>nonE</i>	Not set parity bit
<i>EuEn</i>	Set total bit with signal value of "1" as even numbers
<i>odd</i>	Set total bit with signal value of "1" as odd numbers

Setting group	Parameter	Set range	Factory default	Unit
<i>PAR4</i>	<i>PRTY</i>	<i>nonE / EuEn / odd</i>	<i>nonE</i>	-

6.6.4 Communication stop bit [*PAR4* → *STP*]

You can set the number of bits to mark the end of a transmitted data string.

Set value	Description
<i>1</i>	Set end of data string to 1 bit.
<i>2</i>	Set end of data string to 2 bits.

Setting group	Parameter	Set range	Factory default	Unit
<i>PAR4</i>	<i>STP</i>	<i>1 / 2</i>	<i>2</i>	bit

6.6.5 Communication response waiting time [*PAR4* → *r5y.t*]

Set a standby time to mitigate communication errors when communicating with a slow master device (PC, PLC, etc.). Once a standby time is set, the controller will respond after the defined standby time.

Setting group	Parameter	Set range	Factory default	Unit
<i>PAR4</i>	<i>r5y.t</i>	<i>05 to 99</i>	<i>20</i>	ms



Note

Shorter standby times can cause communication errors in the master device.

6.6.6 Enable/Disable communication write [PAr4 → [OnOff]

This feature can change parameter settings stored in memory through communication with PC, GP, PLC, etc., in order to permit or prohibit writing.

Set value	Description
En.A	Parameter set/change enable by communication.
dl 5.A	Prohibit parameter setting or modification by communication.

Setting group	Parameter	Set range	Factory default	Unit
PAr4	[OnOff]	En.A / dl 5.A	En.A	-



Note

Reading parameter settings is always available even in disable communication write.

6.6.7 USB to Serial connection

Data can be transmitted by SCM-US(USB to Serial converter, sold separately). However, RS485 communication through a USB-to-serial connection is blocked by hardware.

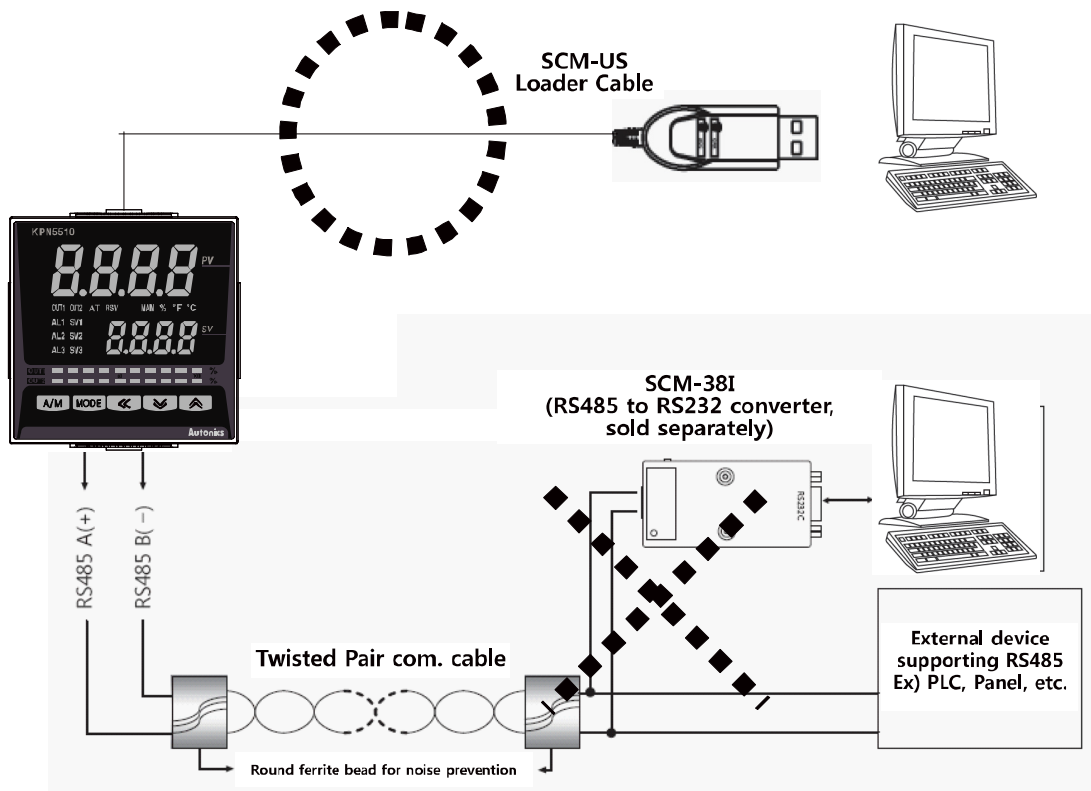

6.7 Additional Features

6.7.1 Monitoring

Refer to the '5.2.3 MV Monitoring and Manual Control Setting'.

6.7.1.1 Control output MV monitoring

Monitors and displays the current control output MV.

6.7.1.1.1. Heating MV monitoring

Displays the current heating MV during heating control or heating and cooling control. Users may manually adjust the MV to control the temperature.

- Measurement range: $H 0.0$ to $H 100$ (Unit%)



Note

It can display MV with a moving decimal point [$H99.9$ $H 100$].

6.7.1.1.2. Cooling MV monitoring

Displays the current cooling MV during cooling control or heating and cooling control. Users may manually adjust the MV to control the temperature.

- Measurement range: $C 0.0$ to $C 100$ (Unit%)



Note

It can display MV with a moving decimal point [$C99.9$ $C 100$].

6.7.1.2 Heater current value monitoring [$PAR 1 \rightarrow [L-R]$]

A feature that monitors and displays the current of a heater (load) being controlled by control output.

Setting group	Parameter	Measurement range	Unit
$PAR 1$	$[L-R]$	0.0 to 50.0	A





Note

Heater (load) current value is measured by a current transformer (CT) and is displayed.

6.7.2 RUN/STOP [PAr 1 → r-5]

Users can run or stop control output by force while in Run mode

The stop command stops control output. Auxiliary output, however, is not affected by the command.

This feature can be enabled by configuring parameters. In addition, the front panel's digital input keys ( ) and digital input terminals (DI-1 and DI-2) can be assigned to the run/stop feature.

Set value	Description
rUn	Forced control output run in Stop mode.
StoP	Forced control output stop in Run mode.

Setting group	Parameter	Set range	Factory default	Unit
PAr 1	r-5	rUn / StoP	rUn	-



Note

With stop enabled, the front panel's SV display indicates **StoP**.

The stop status will remain in effect after turning OFF the power and re-supplying the power. When stop is in effect, STOP MV [St.nu] is output. In case of a sensor break occurring while in STOP, STOP MV [St.nu] is output.

The run/stop setting remains in effect after re-supplying power. If the Digital Input [dⁱ-1, dⁱ-2] feature has been set for RUN/STOP, RUN/STOP feature by modifying front keys or parameter is unable.

6.7.2.1 STOP, control output [PAr 5 → St.nu]

This parameter sets the control output value when in the stop state. With ON/OFF control, select between 100.0 (ON) and 000.0 (OFF). With PID control, the user can adjust the MV between 000.0 and 100.0.

Setting group	Parameter	Set range		Factory default	Unit	
PAr 5	St.nu	Standard control	ON/OFF control	000.0 (OFF)/ 100.0 (ON)	000.0	%
			PID control	000.0 to 100.0	000.0	
		Heating & Cooling control	ON/OFF control	+100.0 (cooling ON) / 000.0 (OFF) / 100.0 (heating ON)	000.0	
			PID control	+100.0 (cooling) to 100.0 (heating)	000.0	



Note

Ignores MV from ON/OFF control or PID control and sends out a control value based on the defined MV.

6.7.2.2 STOP, alarm output [PAR-5 → St.AL]

You can set alarm output for STOP.

Set value	Description
oFF	Alarm output ceases along with a stop under all conditions. (However, reverting to Run mode after a stop in alarm latch or alarm latch and standby sequence restores the alarm output to the previous state.)
Cont	Alarm output continues regardless of control operation.

Setting group	Parameter	Set range	Factory default	Unit
PAR 1	r-5	Cont / oFF	Cont	-

6.7.3 Multi SV

Multi SV function allows users to set multiple SVs [$\bar{n}t.Sv$] and save each setting in Sv0 to Sv3. Users can change Sv-n or select desired SV using external DI (Digital Input, DI-1, DI-2) terminals.

This feature supports up to four SVs which can be independently configurable.

6.7.3.1 Number of multi SV [PAR-5 → $\bar{n}t.Sv$]

This parameter sets the number of Multi SVs. Select the number of Multi SVs required by the control subject.

Number of SVs	SV set
1 EA	SV-0
2 EA	SV-0, SV-1
4 EA	SV-0, SV-1, SV-2, SV-3,

Setting group	Parameter	Set range	Factory default	Unit
PAR 5	$\bar{n}t.Sv$	1 / 2 / 4	1	EA



Note

If the Digital Input [$dI - 1, dI - 2$] feature has been set for multi SV [$\bar{n}t.Sv$], the number of Multi SV [$\bar{n}t.Sv$] is not modified by pressing a key or communication.

6.7.3.2 Multi SV number selection [PAR 1 → SV-n]

You can set the SV(set value) number to be controlled.

Setting group	Parameter	Set range	Factory default	Unit
PAR 1	SV-n	SV-0 / SV-1 / SV-2 / SV-3	SV-0	-

**Note**

The range of figures assigned to each SV (SV No.) varies depending on the number of Multi SVs [n.t.SV] setting.

6.7.3.3 Multi SV set value [PAR 1 → SV-0 / SV-1 / SV-2 / SV-3]

Set the desired set value of multi SV individually.

Setting group	Parameter	Set range	Factory default	Unit
PAR 1	SV-0	SV low-limit [L-SV] to SV high-limit [H-SV]	0	°C, °F, -
	SV-1		0	
	SV-2		0	
	SV-3		0	

6.7.4 Digital input

6.7.4.1 Digital input terminal function [PAR-5 → DI-1/DI-2]

By connecting an external input to a digital input terminal, you can perform preset digital input terminal functions.

Set value	Description
OFF	No function.
STOP	Run/Stop
AL.RE	Forced alarm output clear
MAN	Auto/Manual control selection.
MSV	Multi SV selection.

In the case one of DI-1 or DI-2 being set for Multi SV[MSV], SV-0 is selected as the SV if the terminal's external contact signal is off and SV-1 is selected if the signal is on.

If both DI-1 and DI-2 are configured for Multi SV[MSV], you can select the SV using combinational logic of the terminals. If multi SV [MSV] are changed from 4 to 2, DI-2 will be turned OFF automatically, changed from 4 to 1, both DI-1 and DI-2 will be turned OFF or changed from 2 to 1, concerned DI will be OFF.

DI-1	DI-2	Multi SV NO
OFF	OFF	SV-0
ON	OFF	SV-1
OFF	ON	SV-2
ON	ON	SV-3

Setting group	Parameter	Set range	Factory default	Unit
PAR-5	DI-1	OFF / STOP / AL.RE / MAN / MSV	STOP	-
	DI-2		AL.RE	





Note

When powered on, digital input feature checks always the settings of terminal input.

Multi SV parameter will be activated only if Multi SV is more than 2.

This digital input terminal function operates regardless with lock and password set.

6.7.4.2 Digital input key

With digital input key enabled in Run mode, press and hold   keys at the same time for three seconds to activate the preset function.

6.7.4.2.1. Digital input key function [*PAR5* → *dl - E*]

In order to use the digital input key feature, each function has to be first assigned to the keys.

Set value	Description
<i>StoP</i>	Run/Stop
<i>AL.rE</i>	Forced alarm output clear

Setting group	Parameter	Set range	Factory default	Unit
<i>PAR5</i>	<i>dl - E</i>	<i>StoP / AL.rE</i>	<i>StoP</i>	-





Note

If digital input key and digital input terminal set same, digital input key does not act.

6.7.4.2.2. Digital input key usage

Press the digital input keys on the front panel to execute the function assigned to the keys.

When in Run mode, press and hold   keys to execute the assigned function (run/stop or alarm output deactivation).



Note

If the same function is assigned to a digital input key and the digital input terminal, activation takes place as an "or" function and deactivation as an "and" function. (except Multi SV feature of digital input terminals)

Digital input key functions operate irrespective of password set.

6.7.5 Error

The controller diagnoses input signals for errors and displays messages accordingly. These messages inform the user of device problems.

Message	Input	Description	Output
HHHH	Temperature sensor	Flashes at 0.5-second intervals if the input value is above the input range.	Standard type: Heating: 0%, Cooling: 100% Heating&Cooling: Heating: 0%, Cooling: 100%
	Analog	Flashes at 0.5-second intervals if the input value is over 5 to 10% of high limit or low limit value.	Normal output
LLLL	Temperature sensor	Flashes at 0.5-second intervals if the input value is below the input range.	Standard type: Heating: 100%, Cooling: 0% Heating&Cooling: Heating: 100%, Cooling: 0%
	Analog	Flashes at 0.5-second intervals if the input value is over 5 to 10% of low limit or high limit value.	Normal output
OPEN	Temperature sensor	Flashes at 0.5-second intervals in the event of an input disconnection.	Outputs the set MV at ErMV
	Analog	Flashes at 0.5-second intervals if F.S. is over $\pm 10\%$.	
ERR	Temperature sensor	Flashes at 0.5-second intervals if there is error for setting and it returns to the error-before screen.	-
	Analog		

When input value returns to the input range, alarm is deactivated and it operates normally.



Note

When supplying power or in standard control state, for heating control, if **HHHH** is displayed, it outputs 0%. If **LLLL** is displayed, it outputs 100%. For cooling control, if **HHHH** is displayed, it outputs 100%. If **LLLL** is displayed, it outputs 0%.

When supplying power or in standard control state, for heating & cooling control, if **HHHH** is displayed, it outputs 0% for heating, 100% for cooling. If **LLLL** is displayed, it outputs 100% for heating, 0% for cooling.

6.7.5.1 MV for sensor break error [*OPEN*] [*PAR5* → *Err.nu*]

In the event of a sensor open error you can set control output value to predefined MV instead of ON/OFF control or PID control.

Ignores MV by ON/OFF control or PID control, and sends out a control value based on the defined MV.

Setting group	Parameter	Set range			Factory default	Unit
<i>PAR5</i>	<i>Err.nu</i>	Standard control	ON/OFF control	000.0 (OFF)/ 100.0 (ON)	000.0	%
			PID control	000.0 to 100.0	000.0	
		Heating & Cooling control	ON/OFF control	+100.0 (cooling ON) / 000.0 (OFF) / 100.0 (heating ON)	000.0	
			PID control	+100.0 (cooling) to 100.0 (heating)	000.0	

6.7.6 User level [*PAR5* → *USER*]

You can limit parameter display by setting user level (standard level or high level).

When you set as a standard level user, the main function parameters shaded on the entire parameter list (refer to the '5.4 Parameter Setting Groups') are only displayed.

Parameter	Description
<i>Stnd</i>	Displays main function parameters only.
<i>HIGH</i>	Displays main function parameters and all advanced function parameters.

Setting group	Parameter	Set range	Factory default	Unit
<i>PAR5</i>	<i>USER</i>	<i>Stnd</i> / <i>HIGH</i>	<i>Stnd</i>	-

6.7.7 Lock

6.7.7.1 SV group lock [$PAR5 \rightarrow LC5u$]

You can restrict SV parameter modification by locking SV group parameters, which include SV selection, digital input key (di - E),  key for monitoring and manual control, parameter reset (init), etc.

Set value	Function
on	Lock SV setting group
off	Unlock SV setting group

Setting group	Parameter	Set range	Factory default	Unit
PAR5	LC5u	on / off	off	-

6.7.7.2 Parameter group lock [$PAR5 \rightarrow LC.P1/LC.P2/LC.P3/LC.P4/LC.P5$]

Lock or unlock individual parameter groups from PAR 1 (Parameter 1 group) to PAR 5 (Parameter 5 group). Even if parameter group is locked, you can read parameter settings.

However, SV setting lock and parameter group lock[LC5u/LC.P□] of Parameter 5 group [PAR5] are available to change SV.



Parameter	Description
on	Parameter group lock
off	Parameter group unlock

Parameter	Description
LC.P1	Parameter 1 group lock
LC.P2	Parameter 2 group lock
LC.P3	Parameter 3 group lock
LC.P4	Parameter 4 group lock
LC.P5	Parameter 5 group lock

Setting group	Parameter	Set range	Factory default	Unit
PAR5	LC.P1 to LC.P5	on / off	off	-

6.7.8 Parameter initialization [init]

This function is to initialize all parameters in memory to factory defaults.

Press the front    keys for 5 sec. in RUN mode, init parameter is displayed. Select YES and all parameters are initialized.

Setting group	Parameter	Set range	Factory default	Unit
-	init	YES / no	no	-



Note

If the password feature is activated, it is required to enter the password to activate this function. Initializing the parameters also resets the password.

6.7.9 Password [*PR5* → *Pd*]

Only the user who enters password can change and set SV setting group features (except by digital input key) and parameter 1 to 5 groups features. Password setting applies to SV setting group features (except by digital input key), and parameter 1 to 5 groups features comprehensively.

Changing the password setting automatically activates password function. Setting the password to *0000*, however, it cannot use password. *0001* is a read-only password. Under this password, any users can check parameter settings without knowing the password. The user, however, cannot change parameter settings.

Accessing the *Pd* parameter with the read-only password displays a coded form of the setting.



- Set method

1st Press the  key in RUN mode.

2nd Press the  key, select *PR5* group and press the  key.

3rd Press the  key and search *Pd*.

4th Press the  key and select the desired digit.

5th Press the  key to set password (0000, 0002 to 9999) and press the  key.

6th Repeat step 4 and 5 and enter the set password.

7th Press the  key or do not enter any keys for 3 sec. to save the password.

Setting group	Parameter	Set range	Factory default	Unit
<i>PR5</i>	<i>Pd</i>	<i>0000</i> (Password OFF), <i>0002</i> to <i>9999</i> (Password ON)	<i>0000</i>	-





Note

Digital input terminal feature and digital input key function are not related with password.

6.7.9.1 Enter password [P₅₅]

When the password is set and entering SV setting group or parameter set groups in RUN mode, [P₅₅] parameter to check the set password appears. Enter the set password and you can enter the set parameters.

- Set method
 - 1st Enter SV setting group or parameter set groups.
 - 2nd P₅₅ parameter appears. Press the  key to select desired digit.
 - 3rd Press the  key and enter the password (0001 to 9999) and press the  key.

Setting group	Parameter	Set range	Factory default	Unit
P ₅₅	P ₅₅	0001 (read-only password), 0002 to 9999	0001	-



Note

This parameter appears except 0000 password. If you do not know the password, 0001 password only can read parameters.



When entering wrong password, coded form of the set password SV and error message [Err] flash by 1 sec. in turns at the SV display part.

6.7.9.2 Password recovery

Entering wrong password displays a coded form of the password on the SV display part.

Submit this code to Autonics to recover your lost password.

When entering wrong password (the set password is 1234)



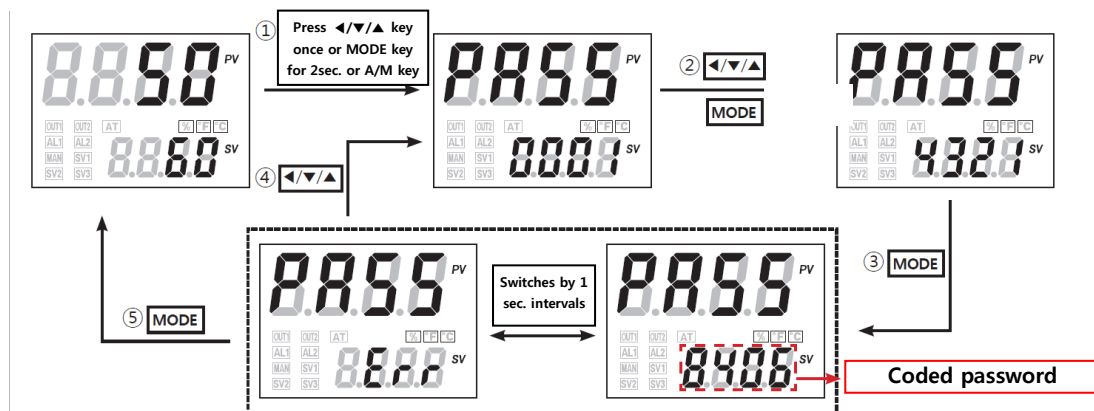

- 1st Enter SV setting group or parameter set groups.
- 2nd P₅₅ parameter appears. Press the  key and select the desired digit.
- 3rd Press the  key and enter the password and press the  key. When entering wrong password 4321.



When entering wrong password, a coded form of the password and Err flash by 1 sec. in turns at the SV display part.

7 Parameter Description by Setting group

7.1 SV Setting group [5_U]

Parameter		Description	Set range	Unit	Factory default
5 _U	Set Value	SVSet value	Within L - 5 _U to H - 5 _U	°C/°F/-	0
▲+▼ key	Digital Input Key Execute	Digital input key	Press   keys for 3sec.	-	-
 key	Auto_Manual Monitoring/Control	MV monitoring /Manual control key	Press  key for over 1 sec.	-	-
INIT	Parameter Initialize	Parameter factory default initialization	no / YES	-	no

7.2 MV monitoring/Manual control setting group [\bar{n} _U]

Parameter		Description	Set range	Unit	Factory default
H- \bar{n} _U	Heating_MV	Heating MV	H 0.0 to H 100	%	-
C- \bar{n} _U	Cooling_MV	Cooling MV	C 0.0 to C 100	%	-

※ It monitors heating and cooling MV and controls manually.

7.3 Parameter 1 setting group [PAR 1]

Parameter		Description	Set range	Unit	Factory default
r-5	RUN_STOP	Control output RUN/STOP	rUn / StopP	-	rUn
5u-n	Multi SV No	Multi SV number	5u-0 / 5u-1 / 5u-2 / 5u-3	-	5u-0
Ct-A	Heater Current Monitoring	Heater current value monitoring	0.0 to 50.0 (display range)	A	0.0
AL 1.L	Alarm1_Low	Alarm output1 low-limit set value	Deviation alarm: -F.S. to F.S. Absoulte value alarm: within display range	°C/°F/ -	1550
AL 1.H	Alarm1_High	Alarm output1 high-limit set value			1550
AL 2.L	Alarm2_Low	Alarm output2 low-limit set value			1550
AL 2.H	Alarm2_High	Alarm output2 high-limit set value			1550
AL 3.L	Alarm3_Low	Alarm output3 low-limit set value			0000
AL 3.H	Alarm3_High	Alarm output3 high-limit set value			0000
5u-0	SV-0 Setting Value	SV-0 Set value	Within L-5u to H-5u	°C/°F/ -	0000
5u-1	SV-1 Setting Value	SV-1 Set value	Within L-5u to H-5u	°C/°F/ -	0000
5u-2	SV-2 Setting Value	SV-2 Set value	Within L-5u to H-5u	°C/°F/ -	0000
5u-3	SV-3 Setting Value	SV-3 Set value	Within L-5u to H-5u	°C/°F/ -	0000

7.4 Parameter 2 Setting group [PAR-2]

Parameter		Description	Set range	Unit	Factory default
<i>At</i>	Auto-Tuning Execute	Auto-tuning RUN/STOP	OFF / ON	-	OFF
<i>H-P</i>	Heating_ Proportional Band	Heating, proportional band	000.1 to 999.9	°C/°F, %	010.0
<i>C-P</i>	Cooling_ Proportional Band	Cooling, proportional band			
<i>H-I</i>	Heating_Integral Time	Heating, integral time	0000 to 9999	sec.	0000
<i>C-I</i>	Cooling_Integral Time	Cooling, integral time			
<i>H-d</i>	Heating_Derivative Time	Heating, derivative time	0000 to 9999	sec.	0000
<i>C-d</i>	Cooling_Derivative Time	Cooling, derivative time			
<i>db</i>	Dead_Overlap band	Heating&Cooling, control deadband	P/P, P/ONOFF, ONOFF/P control : -proportional band to 0.0 to +proportional band (when proportional bands are different, it is based on the small value) ONOFF/ONOFF control : -999 to 0999 (temperature H) -199.9 to 999.9 (temperature L)	Digit	0000
			-99.9 to 099.9 (analog)	%F.S.	000.0
<i>rEst</i>	Manual Reset	Proportional control, manual reset	000.0 to 100.0	%	050.0
<i>H.HYS</i>	Heating_ON Hysteresis	Heating, hysteresis	001 to 100 (000.1 to 100.0)	Digit	002 (002.0)
<i>H.oSt</i>	Heating_OFF Offset	Heating, OFF point offset	000 to 100 (000.0 to 100.0)	Digit	000
<i>C.HYS</i>	Cooling_ON	Cooling, hysteresis	001 to 100	Digit	002

Parameter		Description	Set range	Unit	Factory default
	Hysteresis		(000.1 to 1000.0)		(002.0)
C.o5t	Cooling_OFF Offset	Cooling, OFF point offset	000 to 100 (000.0 to 100.0)	Digit	000
L-ñu	MV Low Limit	MV low limit	000.0 to H-ñu-0.1 (Standard control) -100.0 to 000.0 (Heating&Cooling)	%	-1000
H-ñu	MV High Limit	MV high limit	L-ñu+0.1 to 100.0 (Standard control) 000.0 to 100.0 (Heating&Cooling)	%	1000
rAñU	Ramp_Up Rate	Ramp-Up change rate	000 to 999 (000.0 to 999.9)	Digit	000
rAñd	Ramp_Down Rate	Ramp-Down change rate	000 to 999 (000.0 to 999.9)	Digit	000
r.Unt	Ramp Time Unit	Ramp time unit	SEC / ñl n / Hour	-	ñl n

7.5 Parameter 3 Setting group [PAR3]

Parameter		Description	Set range	Unit	Factory default	
<i>I n - t</i>	Input Type	Input type	Refer to input range chart	-	<i>℄C.R.H</i>	
<i>U n i t</i>	Unit	Sensor temperature unit	<i>°C / °F</i>	-	<i>°C</i>	
<i>L - r G</i>	Low Input Range	Analog low-limit input value	Min. range to <i>H - r G</i> - F.S.10%	Digit	<i>00.00</i>	
<i>H - r G</i>	High Input Range	Analog high-limit input value	<i>L - r G</i> +F.S.10% to Max. range	Digit	<i>10.00</i>	
<i>dot</i>	Scaling Decimal Point	Scale value decimal point position	<i>0 / 0.0 / 0.00 / 0.000</i>	-	<i>0.0</i>	
<i>L - 5 C</i>	Low Scailing	Scale low-limit display value	<i>-9999 to 9999</i>	-	<i>000.0</i>	
<i>H - 5 C</i>	High Scailing	Scale high-limit display value	<i>-9999 to 9999</i>	-	<i>100.0</i>	
<i>dUnit</i>	Display Unit Lamp	Display unit	<i>°C / °F / °℄ / °FF</i>	-	<i>°℄</i>	
<i>I n - b</i>	Input Bias	Input correction	<i>-999 to 0999</i> (<i>-9999 to 9999</i>)	Digit	<i>0000</i>	
<i>̄R u F</i>	Input Digital Filter	Input digital filter	<i>000.1 to 120.0</i>	sec.	<i>000.1</i>	
<i>L - 5 u</i>	SV Low Limit	SV low-limit	Input low-limit [<i>L - 5 C</i>] to <i>H - 5 u</i> -1Digit	<i>°C/°F / %</i>	<i>-200</i>	
<i>H - 5 u</i>	SV High Limit	SV high-limit	<i>L - 5 u</i> + 1digit to input high-limit [<i>H - 5 C</i>]	<i>°C/°F / %</i>	<i>1350</i>	
<i>o - F t</i>	Control Operating Type	Control output operation mode	Standard	<i>HEAt / CooL</i>	<i>HEAt H-C</i>	<i>HEAt</i>
			Heating & Cooling	<i>HEAt / CooL / H-C</i>		<i>H-C</i>
<i>C - ̄n d</i>	Control Method	Temperature control type	Standard	<i>Pi d / o n o F</i>	<i>Pi d P.P</i>	<i>Pi d</i>
			Heating & Cooling	<i>P.P/P.o n / o n .P / o n .o n</i>		<i>P.P</i>
<i>A t t</i>	Auto-Tuning Type	Auto-tuning mode	<i>tUn 1 / tUn 2</i>	-	<i>tUn 1</i>	
<i>o U t 1</i>	Output1(SSR_C	OUT1 control output	Standar	<i>rLY /</i>	<i>rLY</i>	<i>rLY</i>

Parameter		Description	Set range		Unit	Factory default
	urr) Type	type	d	55r / CUrr		
			Heating & Cooling	55r / CUrr	55r	55r
o1.nA	OUT1 Current Range	OUT1 current output range	4-20 / 0-20		-	4-20
oUt2	Output2(SSR_Curr) Type	OUT2 control output type	55r / CUrr		-	55r
o2.nA	OUT2 Current Range	OUT2 current output range	4-20 / 0-20		-	4-20
H-t	Heating_Control Time	Heating, control time	000.1 to 120.0		sec.	020.0 (Relay)
C-t	Cooling_Control Time	Cooling, control time	000.1 to 120.0		sec.	000.0 (SSR)

7.6 Parameter 4 Setting group [PAR-4]

Parameter		Description	Set range	Unit	Factory default
AL-1	Alarm1 Mode	Alarm output1 operation mode	OFF / duCC / JJdu / JduC / CduJ / PuCC / JJPu / LbA / SbA / HbA	-	duCC
AL1.t	Alarm1 Type	Alarm output1 option/type	AL-A / AL-b / AL-C / AL-d / AL-E / AL-F	-	AL-A
A1.HY	Alarm1 Hysteresis	Alarm output1 hysteresis	001 to 100 (000.1 to 100.0)	Digit	001
A1.n	Alarm1 NO/NC	Alarm output1 contact type	no / nC	-	no
A1.on	Alarm1 ON Delay Time	Alarm output1 ON delay time	0000 to 3600	sec.	0000
A1.oF	Alarm1 OFF Delay Time	Alarm output1 OFF delay time	0000 to 3600	sec.	0000
AL-2	Alarm2 Mode	Alarm output2 operation mode	OFF / duCC / JJdu / JduC / CduJ / PuCC / JJPu / LbA / SbA / HbA	-	JJdu
AL2.t	Alarm2 Type	Alarm output2 option/type	AL-A / AL-b / AL-C / AL-d / AL-E / AL-F	-	AL-A
A2.HY	Alarm2 Hysteresis	Alarm output2 hysteresis	001 to 100 (000.1 to 100.0)	Digit	001
A2.n	Alarm2 NO/NC	Alarm output2 contact type	no / nC	-	no
A2.on	Alarm2 ON Delay Time	Alarm output2 ON delay time	0000 to 3600	sec.	0000
A2.oF	Alarm2 OFF Delay Time	Alarm output2 OFF delay time	0000 to 3600	sec.	0000
AL-3	Alarm3 Mode	Alarm output3 operation mode	OFF / duCC / JJdu / JduC / CduJ / PuCC / JJPu / LbA / SbA / HbA	-	LbA
AL3.t	Alarm3 Type	Alarm output3 option/type	AL-A / AL-b / AL-C / AL-d / AL-E / AL-F	-	AL-A

Parameter		Description	Set range	Unit	Factory default
<i>A3.HY</i>	Alarm3 Hysteresis	Alarm output3 hysteresis	<i>00 1</i> to <i>100</i> (<i>000.1</i> to <i>100.0</i>)	Digit	<i>00 1</i>
<i>A3.n</i>	Alarm3 NO/NC	Alarm output3 contact type	<i>no / nC</i>	-	<i>no</i>
<i>A3.ON</i>	Alarm3 ON Delay Time	Alarm output3 ON delay time	<i>0000</i> to <i>3600</i>	sec.	<i>0000</i>
<i>A3.OF</i>	Alarm3 OFF Delay Time	Alarm output3 OFF delay time	<i>0000</i> to <i>3600</i>	sec.	<i>0000</i>
<i>LbRt</i>	LBA Time	LBA monitoring time	<i>0000</i> to <i>9999</i>	sec.	<i>0000</i>
<i>LbRb</i>	LBA Band	LBA detection band	<i>0000</i> to <i>999</i> (H) <i>000.0</i> to <i>99.99</i> (L) <i>000.0</i> to <i>99.99</i> (analog)	°C/°F %	<i>002</i>
<i>AO.n 1</i>	Analog Output Mode	Analog transmission output value	<i>Pu / Su / H-nu</i> <i>/ C-nu</i>	-	<i>Pu</i>
<i>F5.L</i>	Low Out Scale	Transmission output low-limit value	F.S.	-	<i>-200</i>
<i>F5.H</i>	High Out Scale	Transmission output high-limit value	F.S.	-	<i>1350</i>
<i>Adr 5</i>	Unit Address	Communication address	<i>0 1</i> to <i>127</i>	-	<i>0 1</i>
<i>bPS</i>	Bit Per Second	Communication speed	<i>24 / 48 / 96 / 192</i> <i>/ 384</i>	-	<i>96</i>
<i>Prty</i>	Parity Bit	Communication parity bit	<i>nonE / EuEn / odd</i>	-	<i>nonE</i>
<i>StP</i>	Stop Bit	Communication stop bit	<i>1 / 2</i>	-	<i>2</i>
<i>r5yt</i>	Respons Waiting Time	Communication response waiting time	<i>5</i> to <i>99</i>	ms	<i>20</i>
<i>Cony</i>	Communication Write	Communication write enable/disable	<i>En.A / dl 5.A</i>	-	<i>En.A</i>

7.7 Parameter 5 Setting group [PAr5]

Parameter		Description	Set range	Unit	Factory default	
nE.Sv	Multi SV	Number of multi-SV	1 / 2 / 4	EA	1	
dI - E	Digital Input Key Function	Front DI input key function	0 : OFF 1 : AL 2 : STOP 3 : AL RE	-	STOP	
dI - 1	Digital Input 1 Func	DI-1 input terminal function	OFF / STOP / AL RE / nAn / nE.Sv / rE.Sv	-	OFF	
dI - 2	Digital Input 2 Func	DI-2 input terminal function		-	OFF	
rE.Sv		Remote SV	OFF/on	-	OFF	
rI nb		Remote SV low-limit value correction	-999 to 999 (-9999 to 9999)	-	0000	
rSPn		Remote SV high-limit value correction	0.100 to 5.000	-	1.000	
bAr		Bar graph	Standard control	OFF / OUT 1	OUT 1	OUT 1
			Heating & Cooling	OFF / OUT 1 / OUT 2 / ALL	ALL	ALL
IE.nv	Initial Manual MV	Manual control, initial manual	OUT 0 / Pr.nv	-	OUT 0	
Pr.nv	Preset Manual MV	Manual control, reset manual	000.0 to 100.0 (Standard control) -100.0 to 100.0 (Heating&Cooling)	%	000.0	
Er.nv	Error MV	Sensor error, MV	000.0 to 100.0 (Standard control) -100.0 to 100.0 (Heating&Cooling)	%	0000	
St.nv	Stop MV	Control stop, MV	000.0 to 100.0 (Standard control) -100.0 to 100.0 (Heating&Cooling)	%	0000	
St.AL	Stop AlarmOut	Control stop, Alarm output	Cont / OFF	-	Cont	
USER	User Level	User level	Stnd / HIGH	-	Stnd	
LC.Sv	Lock SV	SV lock setting	on / OFF	-	OFF	
LC.P 1	Lock Parameter 1	Parameter1 group lock	on / OFF	-	OFF	

Parameter		Description	Set range	Unit	Factory default
<i>LC.P2</i>	Lock Parameter 2	Parameter2 group lock	<i>on / off</i>	-	<i>off</i>
<i>LC.P3</i>	Lock Parameter 3	Parameter3 group lock	<i>on / off</i>	-	<i>off</i>
<i>LC.P4</i>	Lock Parameter 4	Parameter4 group lock	<i>on / off</i>	-	<i>off</i>
<i>LC.P5</i>	Lock Parameter 5	Parameter5 group lock	<i>on / off</i>	-	<i>off</i>
<i>Pwd</i>	Password Setting	Password set	<i>0000</i> : Password function Off <i>0002 to 9999</i>	-	<i>0000</i>

7.8 Password input parameter

Parameter		Description	Set range	Unit	Factory default
<i>PASS</i>	Password	Password input	<i>0001 to 9999</i> (<i>0001</i> for reading)	-	<i>0001</i>

7.9 Initialized parameters by changing the related parameters

Changed parameter	Description	Initialized parameters
<i>Input</i>	Input type	<i>SV-n, AL 1.L, AL 1.H, AL 2.L, AL 2.H, AL 3.L, AL 3.H, SV0~SV3, db, H.HYS, H.oSt, C.HYS, C.oSt, rAnU, rAnD, r.Unt, L-rG, H-rG, doE, L-SC, H-SC, d.Unt, In-b, L-Su, H-Su, LbA.t, LbA.b, Ao-n, F5-L, F5-H.</i>
<i>Unit</i>	Temperature unit	Except <i>L-rG, H-rG, doE, L-SC, H-SC, d.Unt</i> , these are same as the initialized parameters of when changing input type.
<i>H-Su</i>	SV high-limit value	<i>SV > H-Su</i> , SV is initialized as <i>H-Su</i>
<i>L-Su</i>	SV low-limit value	<i>SV < L-Su</i> , SV is initialized as <i>L-Su</i>
<i>o-Fe</i>	Control output operation mode	<i>L-nu, H-nu, C-nd, Er.nu, Pr.nu, St.nu</i>
<i>C-nd</i>	Temperature control type	<i>L-nu, H-nu, Er.nu, Pr.nu, St.nu</i>
<i>AL-1, AL-2, AL-3</i>	Alarm mode/option	<i>AL 1.L, AL 1.H, AL 2.L, AL 2.H, AL 3.L, AL 3.H</i>

8 DAQMaster

8.1 Overview

DAQMaster is a comprehensive device management program that can be used with Autonics thermometers, panel meters, pulse meters, counters, recorders, and indicators, etc.

DAQMaster provides GUI control for easy and convenient management of parameters and multiple device data monitoring.

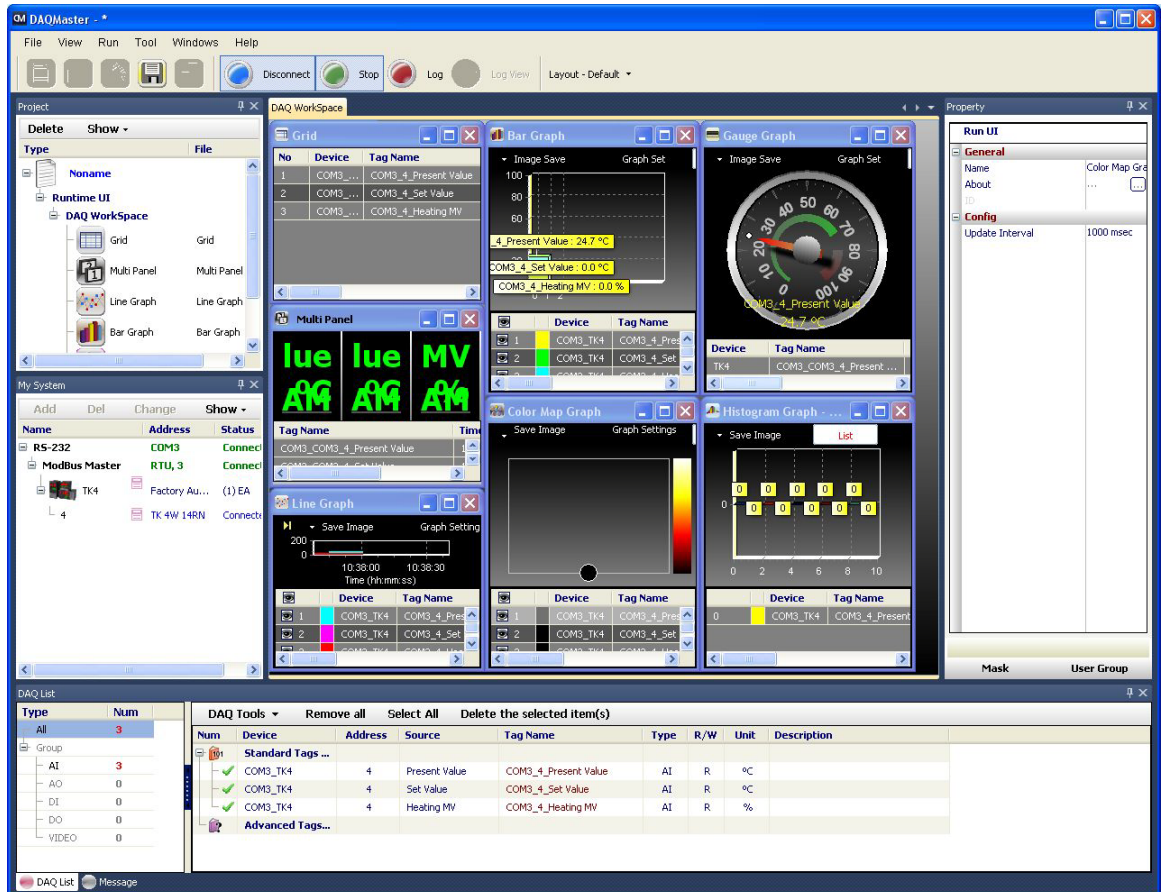

Note

For more descriptions, visit our web site (www.autonics.com) and download 'DAQMaster user manual'.

8.2 Features

DAQMaster has the following features.

(1) Supports multi-device

- Simultaneously monitor multiple devices and set parameters.
- Simultaneously connect units with different addresses in a single device.
- Use Modbus Remote Terminal Unit (RTU) to enable the use of multiple RS232 ports.

(2) Device scan

In cases of multiple units (with different addresses) connected together, use unit scan to automatically search for units.

(3) Convenient user interface

Freely arrange the windows for data monitoring, attributes, and projects.
Saving a project also saves the screen layout.

(4) Project management

You can save added device information, data monitoring screen layouts, and I/O source selection as project files. Open project files to load the saved settings.
Provides a project list for simple and easy project file management.

(5) Monitoring data log

When monitoring, save data log files as either DAQMaster data files (.ddf) or CSV (.csv) files. Open files saved in the .csv format directly from Microsoft Excel.
Define log data file naming/saving rules and destination folders to make file management convenient.

(6) Data analysis

Perform spreadsheet and graph analyses of .ddf data files using DAQMaster's data analysis feature. Save spreadsheet data as .rtf, .txt, .html, or .csv files.

(7) Modbus map table reporting

Print address map reports of registered Modbus devices. Modbus map table reports can be saved in .html and .pdf formats.

(8) Supports multi-language

Supports Korean, English, Japanese and Simplified Chinese.
To add a different language, modify the files in the Lang folder, rename, and save.

(9) Supports script

Uses the Lua Script language and deals with different I/O processes for individual devices.

8.3 KPN series special features

Parameter mask and user parameter group is available by DAQMaster. Visit our website (www.autonics.com) to download DAQMaster program and the user manual.

8.3.1 Parameter mask

This feature is able to hide unnecessary parameters to user environment or less frequently used parameters in parameter group. Masked parameters are not only displayed. The set value of masked parameters are applied.

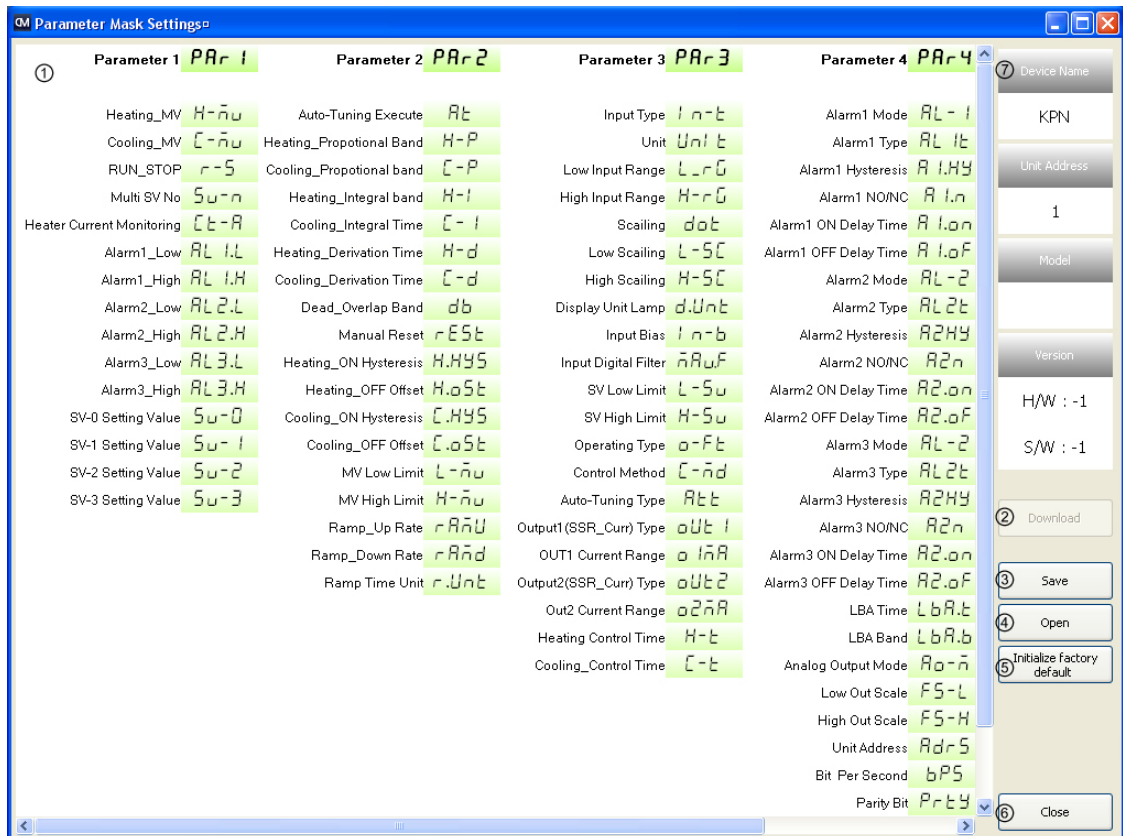

No	Item	Description
①	Parameter mask selection	Select the to-be masked parameters. Right-click the to-be masked parameters and they turn gray.
②	Download	Applies the set masked parameters to the device.
③	Save	Saves the set masked parameters as a mask information file.
④	Open	Opens the saved mask information file.
⑤	Initialize factory default	Clears the set for the masked parameters. Download this setting to apply it to the device.
⑥	Close	Closes the Parameter Mask Settings dialog.
⑦	Device information	Displays device name, unit address, model name, and version.



Parameter Mask Settings

Parameter 1	PAR 1	Parameter 2	PAR 2	Parameter 3	PAR 3	Parameter 4	PAR 4
Heating_MV	H-nu	Auto-Tuning Execute	At	Input Type	in-t	Alarm1 Mode	AL-1
Cooling_MV	C-nu	Heating_Proportional Band	H-P	Unit	Unit	Alarm1 Type	AL-1t
RUN_STOP	r-S	Cooling_Proportional band	C-P	Low Input Range	L-r0	Alarm1 Hysteresis	A1H4
Multi SV No	Su-n	Heating_Integral band	H-I	High Input Range	H-r0	Alarm1 NO/NC	A1n
Current Monitoring	Ct-A	Cooling_Integral Time	C-I	Scaling	dot	Alarm1 ON Delay Time	A1on
Alarm1_Low	AL1L	Heating_Derivation Time	H-d	Low Scailing	L-S0	Alarm1 OFF Delay Time	A1of
Alarm1_High	AL1H	Cooling_Derivation Time	C-d	High Scailing	H-S0	Alarm2 Mode	AL-2
Alarm2_Low	AL2L	Dead_Overlap Band	db	Display Unit Lamp	d.Unt	Alarm2 Type	AL2t
Alarm2_High	AL2H	Manual Reset	rESt	Input Bias	in-b	Alarm2 Hysteresis	A2H4
Alarm3_Low	AL3L	Heating_ON Hysteresis	H.H45	SV Low Limit	L-Su	Alarm2 NO/NC	A2n
Alarm3_High	AL3H	Heating_OFF Offset	H.o5t	SV High Limit	H-Su	Alarm2 ON Delay Time	A2on
SV-0 Setting Value	Su-0	Cooling_ON Hysteresis	C.H45	Operating Type	o-Ft	Alarm2 OFF Delay Time	A2of
SV-1 Setting Value	Su-1	Cooling_OFF Offset	C.o5t	Control Method	C-n-d	Alarm3 Mode	AL-2
SV-2 Setting Value	Su-2	MV Low Limit	MV-Lnu	Auto-Tuning Type	Att	Alarm3 Type	AL2t
SV-3 Setting Value	Su-3	MV High Limit	MV-Hnu	Output1(SSR_Curr) Type	oUt1	Alarm3 Hysteresis	A2H4
		Ramp_Up Rate	rAnU	OUT1 Current Range	o1nA	Alarm3 NO/NC	A2n
		Ramp_Down Rate	rAnd	Output2(SSR_Curr) Type	oUt2	Alarm3 ON Delay Time	A2on
		Ramp Time Unit	r.Unt	Out2 Current Range	o2nA	Alarm3 OFF Delay Time	A2of
				Heating Control Time	H-t	LBA Time	LbA.t
				Cooling_Control Time	C-t	LBA Band	LbA.b
						Analog Output Mode	AO-n
						Low Out Scale	F5-L
						High Out Scale	F5-H
						Unit Address	Adr5
						Bit Per Second	bP5
						Parity Bit	P-r4

Digit

Device Name: KPN

Unit Address: 1

Model

Version

H/W : -1

S/W : -1

Download

Save

Open

Initialize factory default

Close

Example of masking alarm, SV setting parameters of parameter 1 group, input type, unit of parameter 3 group, and all of parameter 4 group.

8.3.2 User parameter group [PARU]

This feature is able to set the frequently used parameters to the user parameter group. You can quickly and easily set parameter settings.

User parameter group can have up to 30 parameters. You can set this by the integrated device management program, DAQMaster. For more information, refer to the DAQMaster user manual.

Visit our webpage (www.autonics.com) to download DAQMaster program and the user manual.

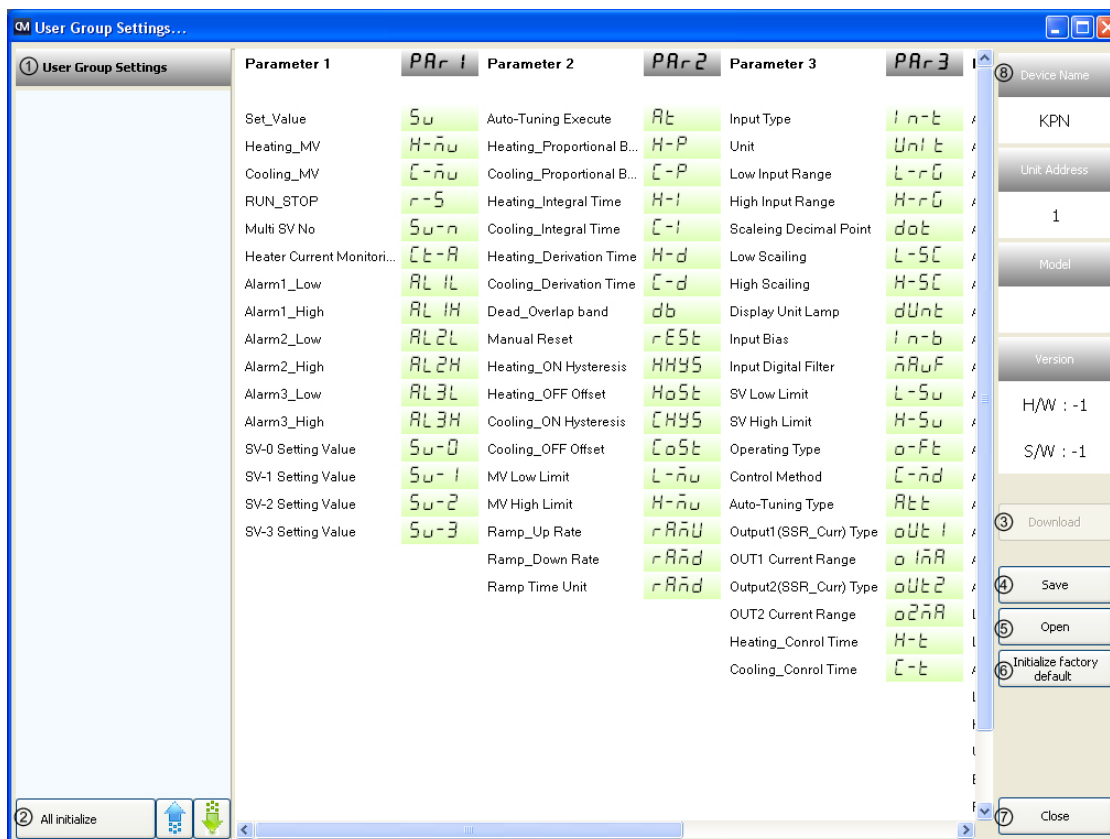

No	Item	Description
①	User group parameters	Displays the selected parameters as user group parameter Double-click the parameters for the user group, and these parameters turn gray. To delete the parameters at the user group, double-click the parameters.
②	User group selection	- All initialize: Initializes the set user group. - ↑, ↓ : Changes the selected parameter order up/down.
③	Download	Applies the set user group to the device.
④	Save	Saves the set user group as a user group information file.
⑤	Open	Opens the saved user group file.
⑥	Initialize factory default	Clears the set for the user group. Download this setting to apply it to the device.
⑦	Close	Closes the User Group Settings dialog.
⑧	Device information	Displays device name, unit address, model name, and version.



QM User Group Settings...

User Group Settings	Parameter 1	PAR 1	Parameter 2	PAR 2	Parameter 3	PAR 3	Parameter 4	PAR 4
Set_Value	Set_Value	Su	Auto-Tuning Execute	RLt	Input Type	ln-b	Alarm1 Mode	RL-1
RUN_STOP	Heating_MV	r-s	Heating_Proportional B...	H-P	Unit	Unit	Alarm1 Type	RLt
SV-0 Setting Value	Cooling_MV	Su-0	Cooling_Proportional B...	C-P	Low Input Range	L-rG	Alarm1 Hysteresis	RIHY
SV-1 Setting Value	RUN_STOP	Su-1	Heating_Integral Time	H-I	High Input Range	H-rG	Alarm1 NO/NC	RI n
SV-2 Setting Value	Multi SV No	Su-2	Cooling_Integral Time	C-I	Scaling Decimal Point	doE	Alarm1 ON Delay Time	RIoF
SV-3 Setting Value	Heater Current Monitori...	Su-3	Heating_Derivation Time	H-d	Low Scailing	L-SG	Alarm1 OFF Delay Time	RIoF
Manual Reset	Alarm1_Low	rEst	Cooling_Derivation Time	C-d	High Scailing	H-SG	Alarm2 Mode	RL-2
Input Bias	Alarm1_High	ln-b	Dead_Overlap band	db	Display Unit Lamp	dUnit	Alarm2 Type	RL-2
Alarm1 Mode	Alarm2_Low	RL-1	Manual Reset	rEst	Input Bias	ln-b	Alarm2 Hysteresis	RIHY
Alarm1 Type	Alarm2_High	RLt	Heating_ON Hysteresis	HHYS	Input Digital Filter	nRUF	Alarm2 NO/NC	RI n
Alarm1 Hysteresis	Alarm3_Low	RIHY	Heating_OFF Offset	HoSt	SV Low Limit	L-Su	Alarm2 ON Delay Time	RIoF
Alarm1 NO/NC	Alarm3_High	RI n	Cooling_ON Hysteresis	CHYS	SV High Limit	H-Su	Alarm2 OFF Delay Time	RIoF
Alarm1 ON Delay...	SV-0 Setting Value	RIoF	Cooling_OFF Offset	CoSt	Operating Type	o-rE	Alarm3 Mode	RL-3
Alarm1 OFF Delay...	SV-1 Setting Value	RIoF	MV Low Limit	L-nu	Control Method	C-rd	Alarm3 Type	RL3t
	SV-2 Setting Value	RIoF	MV High Limit	H-nu	Auto-Tuning Type	RLt	Alarm3 Hysteresis	RIHY
	SV-3 Setting Value	RIoF	Ramp_Up Rate	rRnU	Output1(SSR_Curr) Type	oUt 1	Alarm3 NO/NC	RI n
			Ramp_Down Rate	rRnD	OUT1 Current Range	o 1nR	Alarm3 ON Delay Time	RIoF
			Ramp Time Unit	rRnD	Output2(SSR_Curr) Type	oUt 2	Alarm3 OFF Delay Time	RIoF
					OUT2 Current Range	o 2nR	LBA Time	LbAb
					Heating_Control Time	H-t	LBA Band	LbAb
					Cooling_Control Time	C-t	Analog Output Mode	Ro n 1
							Low Out Scale	F5L 1
							High Out Scale	F5H 1
							Unit Address	RdS
							Bit Per Second	bP5

Device Name: KPN
Unit Address: 1
Model: H/W : -1
S/W : -1

Buttons: All Initialize, Download, Save, Open, Initialize factory default, Close

Example of the set user group with SV setting, control output RUN/STOP, alarm output 1 low/high-limit, SV-0/1/2/3 set value, manual reset, input correction, alarm output 1 mode/option/hysteresis/contact type/ON delay time/OFF delay time parameters.

Autonics

Sensors & Controllers

www.autonics.com

Distributor



Major products

- Photoelectric sensors • Fiber optic sensors • Door sensors • Door side sensors • Area sensors
- Proximity sensors • Pressure sensors • Rotary encoders • Connectors/sockets
- Temperature controllers • Temperature/Humidity transducers • SSR/Power controllers
- Counters • Timers • Panel meters • Tachometer/Pulse(Rate)meters • Display units
- Sensor controllers • Switching mode power supplies • Control switches/Lamps/Buzzers
- I/O Terminal Blocks & Cables • Stepper motors/drivers/motion controllers
- Graphic/Logic panels • Field network devices
- Laser marking system(Fiber, CO₂, Nd:YAG) • Laser welding/soldering system
- Recorders • Indicators • Converters • Controllers • Thyristor units
- Pressure transmitters • Temperature transmitters

■ Any proposal for a product improvement and development: Product@autonics.com

Headquarters

116, Ungbigongdan-gil, Yangsan-si, Gyeongsangnam-do, Korea

Overseas Sales Dept.

#402-404, Bucheon Techno Park, 655, Pyeongcheon-ro, Wonmi-gu, Bucheon, Gyeonggi-do, Korea

Tel: 82-32-610-2730 / Fax: 82-32-329-0728 / E-mail: sales@autonics.com

Brazil

Autonics do Brasil Comercial Importadora Exportadora Ltda

Tel: 55-11-2307-8480 / Fax: 55-11-2309-7784 / E-mail: vendas@autonics.com.br

China

Autonics electronic(Jiaxing) Corporation

Tel: 86-573-8216-1900 / Fax: 86-573-8216-1917 / E-mail: china@autonics.com

India

Autonics Corporation - India Liaison Office

Tel: 91-22-2781-4305 / Fax: 91-22-2781-4518 / E-mail: india@autonics.com

Indonesia

PT. Autonics Indonesia

Tel: 62-21-658 66 740 / Fax: 62-21-658 66 741 / E-mail: indonesia@autonics.com

Japan

Autonics Japan Corporation

Tel: 81-265-79-8570 / Fax: 81-265-79-2442 / E-mail: support@autonicsjp.co.jp

Malaysia

Mal-Autonics Sensor Sdn. Bhd.

Tel: 60-3-7805-7190(Hunting) / Fax: 60-3-7805-7193 / E-mail: malaysia@autonics.com

Mexico

Autonics Mexico Sales Office

Tel: 52-55-5207-0019 / Fax: 52-55-1663-0712 / E-mail: ventas@autonics.com

Russia

Autonics Corp. Russia Representative Office

Tel/Fax: 7-495-660-10-88 / E-mail: russia@autonics.com

Turkey

Autonics Otomasyon Ticaret Ltd. Sti.

Tel: 90-216-365-9117 / Fax: 90-216-365-9112 / E-mail: info@autonics.com.tr

USA

Autonics USA, Inc.

Tel: 1-847-680-8160 / Fax: 1-847-680-8155 / E-mail: sales@autonicsusa.net

Vietnam

Autonics Vietnam Representative Office

Tel: 84-8-3771-2662 / Fax: 84-8-3771-2663 / E-mail: vietnam@autonics.com