

LP-A070 Series

Advanced Type 7 inch Color LCD Logic Panel

■ Features

- Lesser restrictions on installing place and easier system configuration and use with PLC, HMI, I/O all-in-one design
- Horizontal/Vertical installation according to environment
- Various communication interface: RS232C, RS422, Ethernet
- Standard I/O: Input 16-point, Output 16-point
- Simultaneous monitoring of multiple addresses and channels
- Monitoring device of the connected controllers even without user screen data
- Multilingual table function: switching language of user screen by touching a button.
- Large capacity of memory:
 - widen range of UB, UW internal device
 - 64MB user screen memory
- Using user screen drawing program 'atDesigner'
 - More variety functions, objects and library image
 - Intuitive user interface
- Motion controller, high speed counter function included
- Equipped with 7 inch TFT LCD of 16,777,216 colors for realizing True color
- Possible to be touched by not only hand but also glove, pen tip or etc. with resistive type touch screen

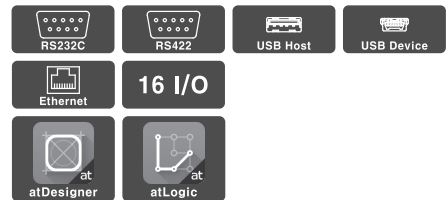

⚠ Please read "Safety Considerations" in the instruction manual before using.



■ Manual

For the detail information and instructions, please refer to user manual and user manual for communication, and be sure to follow cautions written in the technical descriptions (catalog, website). Visit our website (www.autonics.com) to download manuals.

- **atDesigner user manual**
It describes how to design user screen and contains information about LP-A070 HMI function and how to use it.
- **atLogic user manual, atLogic programming manual**
It contains how to install and use atLogic, how to program, and commands for LP Series.
- **GP/LP user manual for communication**
It describes how to connect with external devices such as PLC.
- **LP-A Series user manual**
It describes general information about installation and system of LP-A070.

■ Ordering Information

Model	Item	Series	Screen size	Display unit	Color	Power supply	Interface	Number of I/O	I/O connector type
LP-A070-T9D6-C5R	Logic panel	A Series	7 inch	TFT Color LCD	16,777,216 color	24VDC---	RS232C, RS422, USB HOST, USB DEVICE, Ethernet	IN: 16-point OUT: 16-point	Ribbon cable connector
Terminal block connector									
LP-A070-T9D7-C5R							RS232C: 2, USB HOST, USB DEVICE, Ethernet	IN: 16-point OUT: 16-point	Ribbon cable connector
LP-A070-T9D7-C5T									Terminal block connector

Advanced Type 7 inch Color Logic Panel

■ Specifications

◎ General specifications

Model	LP-A070-T9D6-C5R(T)	LP-A070-T9D7-C5R(T)
Power supply	24VDC---	
Allowable voltage range	90 to 110% of power supply	
Power consumption	Max. 7.2W	
Serial interface	Each port of RS232C, RS422	Two ports of RS232C
USB interface	Each of USB Host, USB Device (USB2.0)	
Ethernet interface	IEEE802.3(U), 10/100Base-T	
Real-time controller	RTC embedded	
Battery life cycle	3 years at 25°C	
Insulated resistance	Over 100MΩ (at 500VDC megger)	
Ground	3rd grounding (max. 100Ω)	
Noise immunity	±0.5kV the square wave noise (pulse width: 1μs) by the noise simulator	
Withstanding voltage	500VAC 50/60Hz for 1 minute	
Vibration	Mechanical	0.75mm amplitude at frequency of 10 to 55Hz (for 1 min) in each X, Y, Z direction for 1 hour
	Malfunction	0.5mm amplitude at frequency of 10 to 55Hz (for 1 min) in each X, Y, Z direction for 10 min
Shock	Mechanical	300m/s ² (approx. 30G) in each X,Y,Z direction for 3 times
	Malfunction	100m/s ² (approx. 10G) in each X,Y,Z direction for 3 times
Environment	Ambient temperature	0 to 50°C, storage: -20 to 60°C
	Ambient humidity	35 to 85% RH, storage: 35 to 85%RH
Protection structure	IP65 (front panel, IEC standard)	
Accessory	Fixing bracket: 4, battery (included)	
Approval	CE 	
Weight ^{※1}	Approx. 742g (approx. 540g)	

※1: The weight includes packaging. The weight in parenthesis is for unit only.

※Environment resistance is rated at no freezing or condensation.

SENSORS

CONTROLLERS

MOTION DEVICES

SOFTWARE

(J)
Temperature
Controllers

(K)
SSRs

(L)
Power
Controllers

(M)
Counters

(N)
Timers

(O)
Digital
Panel Meters

(P)
Indicators

(Q)
Converters

(R)
Digital
Display Units

(S)
Sensor
Controllers

(T)
Switching
Mode Power
Supplies

(U)
Recorders

(V)
HMIs

(W)
Panel PC

(X)
Field Network
Devices

LP-A070 Series

○ Performance specifications

● Display performance

LCD type	TFT Color LCD
Resolution	800×480 dot
Display area	152.4×94.44mm
Color	16,777,216 color
LCD view angle	Within each 50°/60°/65°/65° of top/bottom/left/right
Backlight	White LED
Luminance	Max. 300cd/m ²
Luminance adjustment	Adjustable by software

● Graphic drawing performance

Language ^{※1}	Korean, English
Text	Bitmap ASCII and vector font
Graphic drawing memory	64MB
Number of user screen	100 pages
Touch switch	Analog touch (resistive type)

● Interface type

LP-A070-T9D6-C5R(T)	RS232C, RS422, USB Host, USB Device, Ethernet
LP-A070-T9D7-C5R(T)	RS232C: 2, USB Host, USB Device, Ethernet

● Input

Input point	16-point
Insulation method	Photo coupler insulation
Rated input voltage	24VDC ⁻⁻⁻
Input resistance	Contact X0 to X8: approx. 10mA Contact X9 to XF: approx. 4mA
Voltage range	19.2 to 28.8VDC ⁻⁻⁻
Input resistance	Contact X0 to X8: 3.3kΩ Contact X9 to XF: 5.6kΩ
Response time	0.5ms
Common method	16-point/1 COM
Acceptable wire	0.3 to 0.7mm ²

● Output

Output point	16-point
Power supply	24VDC ⁻⁻⁻
Insulation method	Photocoupler insulation
Rated load voltage	24VDC ⁻⁻⁻
Allowable load voltage range	19.2 to 28.8VDC ⁻⁻⁻
Max. load current	0.1A/1 point, 1.6A/1COM
Max. voltage falling when ON	Max. 0.2VDC ⁻⁻⁻
Common method	16-point/1 COM
Acceptable wire	0.3 to 0.7mm ²

● Control performance

Command	Basic command: 28, application command: 236
Program capacity	8K step
Processing time	Average: approx. 1μs/basic command, application command
I/O control type	Batch processing
Computer control mode	Repeated-doubling method, interrupt processing
Device range	Refer to 'LP-A Series user manual'
Special function	Positioning function, high speed counter ^{※2}

※1: Supported language can be added.

※2: Please refer to 'LP-A Series user manual' for more special function.

Advanced Type 7 inch Color Logic Panel

■ Function

○ Drawing function

Function	Description	
Figure	Line/Multi line/Rectangle/Round rectangle/Polygon/Circle/Fan/Chord/Arc/Rectangle scale/Circle scale/Semicircle scale/Image/Text	
Object	Lamp	Displaying the value of the designated device in bit/word/multi lamp
	Switch	Switching the status of the designated device or object with bit/word/change screen/special/multi switch
	Numeric input/display	Displaying the value of the designated device/Inputting the value to the designated device in number (DEC, HEX, OCT, BIN, REAL)
	Text input/display	Displaying the value of the designated device/Inputting the value to the designated device in text (ASCII/Unicode)
	Call window	Calling a window screen according to the conditions on the value of the designated device
	Message	Displaying a message according to the conditions on the value of the designated device
	Graph	Displaying the value of the designated device in bar/pie/panel meter/statistic/RealTime trend/Logging trend/RealTime distribution/Logging distribution graph
	Clock	Displaying time or date of the time
	Recipe Editor	Editing recipe (project)
	Logging table	Displaying the logging data (project) in a table
	System logging table	Displaying the system logging data (project) in a table
	Alarm explorer	Displaying the alarm group of alarm history (project) in a table
	Alarm list	Displaying the data of alarm history (project) in a table.
	Data list viewer/editor	Displaying/Editing the value of consecutive word device in a table
	Option list	Displaying the data of the designated device/Inputting data to the designated device in a combo box
	Move coord.	Displaying the object/Moving coordinate of the object according to the value of the designated device
Project	Link device	Reading/Writing the data between LP and controller (PLC) as long as setting according to the status of bit/cycle condition
	Flow alarm	Displaying alarm in the flowing text at the set position, when meeting the alarming condition
	Alarm history	Saving data of alarming time, device, and information, when the value of the designated alarm-observing device meets the set condition
	Scheduler	Executing a function (bit on/off/reversal, work value changing, script) according to the set condition (device/cycle)
	Recipe	Reading the value of the multiple devices/Writing the value to the multiple devices at once
	Logging	Saving the value of the designated device, when meeting the condition (device/cycle)
	System Logging	Saving system operation information of LP in a log file
Script	Writing Lua script by user	

○ Logic function

Project	Creating/Managing individual or multiple project. changing PLC type, printing, print setting	
Edit	Managing ladder/mnemonic editor, inserting/deleting line, managing rung, searching rung comment, search, replace, find step	
Tool	Ladder tool: arrow, delete, vertical line, horizontal line, normally open contact, normally closed contact, rising input contact, falling input contact, output instruction, rising output contact, falling output contact, set, reset, application instruction, not instruction, register user defined function, user defined function Program optimization, program checking, program checking options	
View	Ladder/Mnemonic, device/variable name, device name & comment, decimal/hexadecimal view, signed/unsigned view, device/UW view, used devices, zoom in/out, font settings, color settings, toolbar	
Online	Connecting, disconnecting, download, upload, change mode, start monitoring, stop monitoring, read information, change password, verify, change present value, system device, delete, firmware download, communication options	
Debug	Run, stop run, trace, insert/remove break point, stop debugging, debug-step, debug-line, debug-scan, debug-1 scan, step in, step out, debug-bit, debug-word, forced I/O settings	
window	Cascade, horizontal tile, vertical tile, arrange icon, external program connection	
Help	Program information	
Workspace	Program	Ladder/Mnemonic program editor
	Parameter	Common: output while debugging, operating condition for extended module, device latch range settings, default filter value, time driven operation, time interrupt, timer range settings
		Extension: input filter, external interrupt
		Motion: common setting, operation setting, pattern setting
		High speed counter
Variable/Comment	Managing and setting Variable/Comment by bit/word device	
Monitoring	Monitoring and registering device to monitor by bit/word device	

SENSORS

CONTROLLERS

MOTION DEVICES

SOFTWARE

(J) Temperature Controllers

(K) SSRs

(L) Power Controllers

(M) Counters

(N) Timers

(O) Digital Panel Meters

(P) Indicators

(Q) Converters

(R) Digital Display Units

(S) Sensor Controllers

(T) Switching Mode Power Supplies

(U) Recorders

(V) HMI's

(W) Panel PC

(X) Field Network Devices

LP-A070 Series

Unit Description

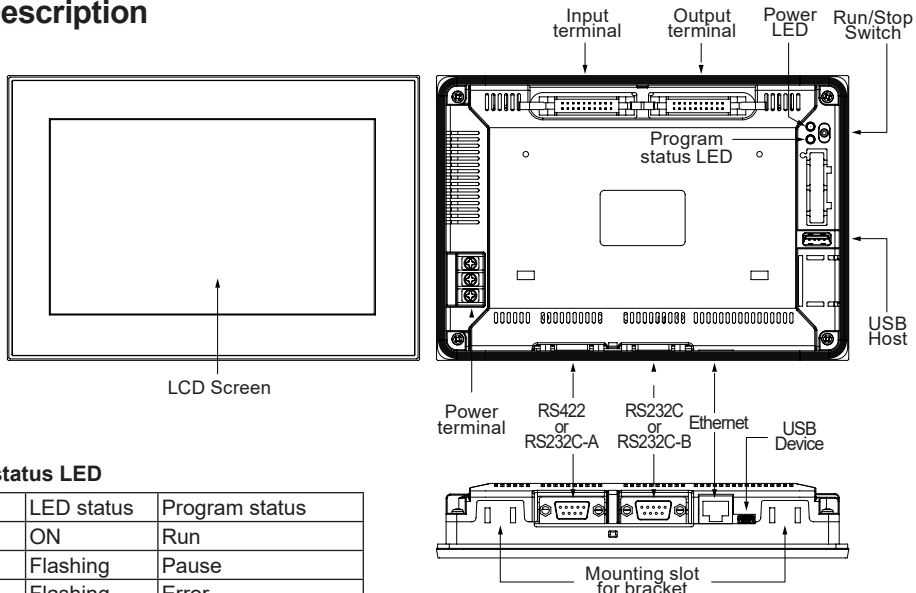

Program status LED

LED color	LED status	Program status
Green	ON	Run
Green	Flashing	Pause
Red	Flashing	Error
Orange	ON	atLogic debugging

Serial port (RS232C/RS422)

All devices connectable to the product including PC, PLC, serial printer, barcode reader, and dedicated connectors can be connected in to both RS232C and RS422 ports.

Port	Pin	Port	Pin
RS232C RS232C-A RS232C-B	1	Non-Used	RS422
	2	RXD	
	3	TXD	
	4	DTR	
	5	SG	
	6	DSR	
	7	Non-Used	
	8	Non-Used	
	9	Non-Used	
D-Sub 9-pin Male		D-Sub 9-pin Female	

Ethernet port

For connecting LAN cable and hub, use direct cable, and for connecting PC directly, use cross cable.

USB

Type	USB Host	USB Device
Function	<ul style="list-style-type: none"> Transferring/Copying data between storage and LP-A070 Firmware upgrade Bar-code reader Printer 	<ul style="list-style-type: none"> Uploading/Downloading a atDesigner project file Used as external storage by connecting to PC

USB HOST can cover up to 32GB of external storage.

It supports only external storage of FAT16 and FAT32 file system.

※For detailed information about each interface, please refer to 'LP-A Series user manual' and 'GP/LP Communication manual'.

Advanced Type 7 inch Color Logic Panel

Dimension

(unit: mm)

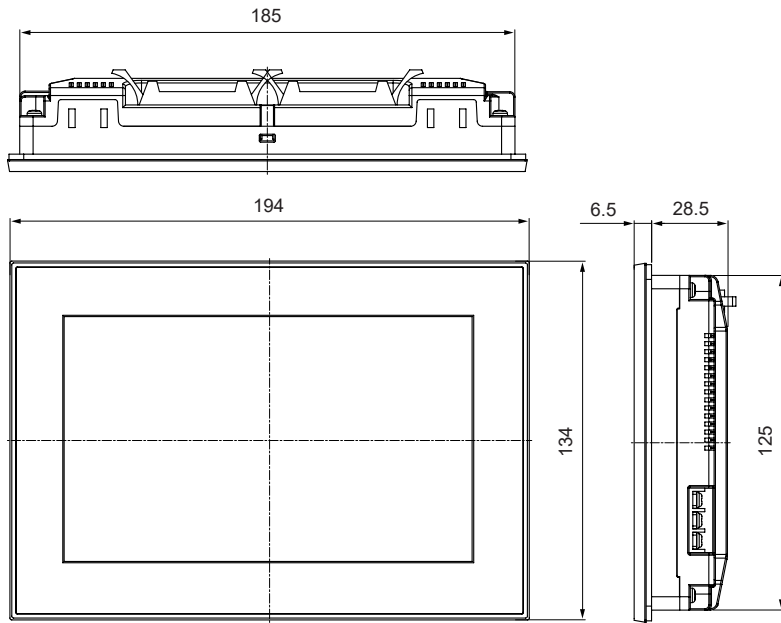

Panel cut out

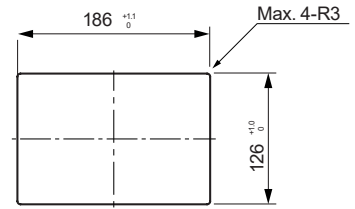

※Panel thickness : max. 4mm

Fixing bracket

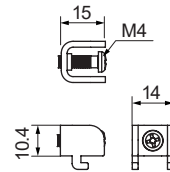

Input/Output Wiring

LP-A070-T9D6(7)-C5R

Input wiring (source type)

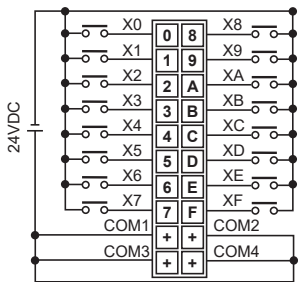

Output wiring (sync type)

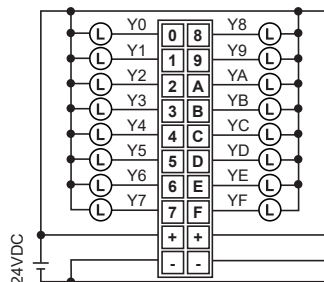

LP-A070-T9D6(7)-C5T

Input wiring (source type)

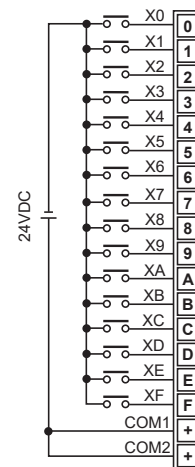

Output wiring (sync type)

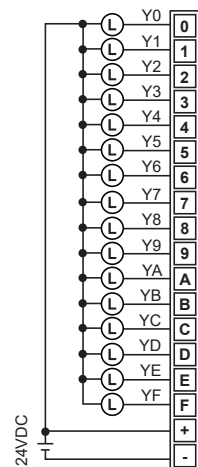

※Check the number of pin on the rear case before wiring.

SENSORS
CONTROLLERS
MOTION DEVICES
SOFTWARE

(J) Temperature Controllers
(K) SSRs
(L) Power Controllers
(M) Counters

(N) Timers

(O) Digital Panel Meters

(P) Indicators

(Q) Converters

(R) Digital Display Units

(S) Sensor Controllers

(T) Switching Mode Power Supplies

(U) Recorders

(V) HMIs

(W) Panel PC

(X) Field Network Devices

LP-A070 Series

■ Installation

1. Set LP-A070 in panel.
2. Set fixing brackets in 4 slots (2 slots is in upper side, 2 slots is in lower side).
3. Tighten fixing bracket with M4 Screw driver and tightening torque is 0.3 to 0.5N·m.

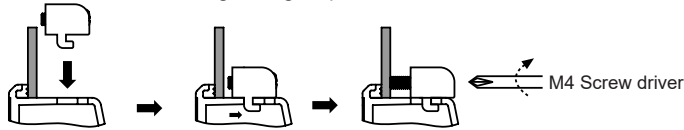

※When installing LP-A070 on panel, make 100mm of space from upper, lower, right, left side of the product on the panel and back side of panel. It is for preventing effect of electromagnetic waves and heat from other controllers.

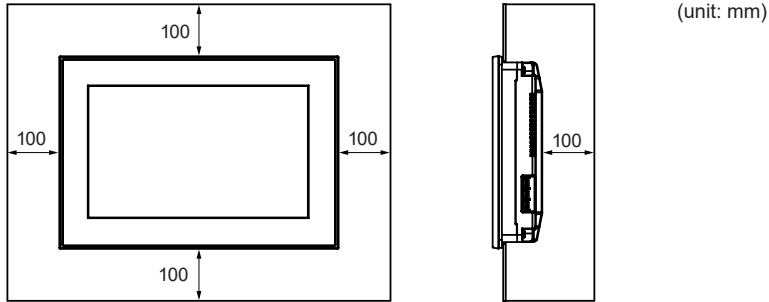

■ Power Wiring

- For power supply, use the wire of which cross section is at least 0.75mm^2 and use the wire of which cross section is at least 1.25mm^2 for grounding.
- Use round terminal with at least 3mm of internal diameter and less than 6mm of external diameter.
- Do not apply power before power line connection.
- Check power polarity.
- Tighten the terminal screw with 0.5 to 0.8N·m torque.
- Ground resistance should be less than 100Ω and ground it separately.

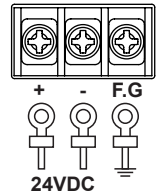

■ Cable (sold separately)

Communication cables connectable into external devices such as PLC are sold separately. Please refer to 'GP/LP user manual for communication' for communication cable.

■ Battery Replacement

Please contact our service center to replace battery.
It may cause an explosion or a fire when using improper battery.

■ Cautions during Use

1. Follow instructions in 'Cautions during Use'. Otherwise, it may cause unexpected accidents.
2. 24VDC power supply should be insulated and limited voltage/current or Class 2, SELV power supply device.
3. Install a power switch or circuit breaker in the easily accessible place for supplying or disconnecting the power.
4. Operate the product after supplying power to the product, input/output equipment, and load. If operate product before supplying power, it may result in output error or malfunction.
5. Keep away from high voltage lines or power lines to prevent inductive noise.
Do not use near the equipment which generates strong magnetic force or high frequency noise.
6. Make a required space around the unit for radiation of heat, and do not block ventilation openings.
7. Do not push the touch panel with a hard and sharp object or push the panel with excessive force.
It may result in fire or malfunction.
8. When skin is smeared with liquid crystal from the broken LCD, rinse with running water for over 15 minutes.
If it gets into the eyes, rinse eyes with running water for over 15 minutes and contact a doctor.
9. This unit may be used in the following environments.
 - ①Indoors (in the environment condition rated in 'Specifications')
 - ②Altitude max. 2,000m
 - ③Pollution degree 2
 - ④Installation category II