

MP5S/Y/W Series

High Performance, Digital Panel Meter

Upgrade

Features

- 3 types of operation mode are added. (total 16 types of operation mode)
Frequency/Revolutions/Speed, Passing speed, Cycle, Passing time, Time interval, Time differential, Absolute ratio, Error ratio, Density, Error, Length measurement 1, Length measurement 2, Interval, Accumulation, Addition/Subtraction-individual input, Addition/Subtraction-phase difference input
- Various output models
Relay triple/quintuple output, NPN/PNP open collector quintuple output, BCD Dynamic output, PV transmission output (current output), **RS485 communication output (changed Modbus RTU)**
- Various functions
Selectable NPN solid state/contact input, PNP solid state/contact input, prescale, delay monitoring, hysteresis, auto-zero time setting, lock setting, data bank function (MP5W Series)
- Max. display range: -19999 to 99999
- Various display units
rpm, rps, Hz, kHz, sec, min, m, mm, mm/s, m/s, m/min, m/h, l/s, l/min, l/h, %, counts, etc.

Shaded parts(■) are changed and added functions from previous MP5.



MP5



MP5Y



MP5W

⚠ Please read "Caution for your safety" in operation manual before using.



Ordering Information

MP 5 Y - 4 N

Output	S	N	Main output (Comparative value output)	Sub output (Display value output)
			Indicator	—
Y	Y	N	Indicator	—
		1	NPN open collector quintuple output	—
		2	PNP open collector quintuple output	—
		3	Indicator	BCD Dynamic
		4	Indicator	PV transmission (current output)
		5	Indicator	RS485 communication
W	W	N	Indicator	—
		A	Relay quintuple output (HH, H, GO, L, LL)	—
		1	Relay triple output (H, GO, L)	—
		2	NPN open collector quintuple output	BCD Dynamic
		4	NPN open collector quintuple output	PV transmission (current output)
		5	PNP open collector quintuple output	PV transmission (current output)
		8	NPN open collector quintuple output	RS485 communication
		9	PNP open collector quintuple output	RS485 communication
		Power supply	2	24VAC 50/60Hz, 24-48VDC
4	100-240VAC 50/60Hz			
Size	S	DIN W48×H48mm		
		Y	DIN W72×H36mm	
		W	DIN W96×H48mm	
Digits	5	99999 (5 Digit)		
		MP	Pulse meter	

Specifications

Series		MP5S	MP5Y	MP5W
Display method		7 Segment LED(Zero Blanking method)		
Character size		W4×H8mm	W7×H14mm	
Display range		-19999 to 99999		
Power supply	AC voltage	100-240VAC 50/60Hz		
	AC/DC voltage	24VAC 50/60Hz, 24-48VDC		
Power consumption	AC voltage	Max. 7.5VA (100-240VAC 50/60Hz)	Max. 9.0VA (100-240VAC 50/60Hz)	Max. 10.0VA (100-240VAC 50/60Hz)
	AC/DC voltage	Max. 6.0VA (24VAC 50/60Hz), Max. 4.5W (24-48VDC)	Max. 7.0VA (24VAC 50/60Hz), Max. 6.2W (24-48VDC)	Max. 7.5VA (24VAC 50/60Hz), Max. 7.0W (24-48VDC)
Permissible voltage range		90 to 110% of rated voltage		
External sensor power		12VDC±10%, 80mA		
Sub power supply		— 24VDC 30mA		
Input frequency		·Solid state input: max. 50kHz (pulse width: min. 10μs) ·Contact input: max. 45Hz (pulse width: min. 11ms)		
Input method		[Voltage input] High: 4.5-24VDC, Low: 0-1.0VDC, Input impedance: 2.4kΩ [No-voltage input] Short-circuit impedance: max. 80Ω, Residual voltage: min. 1V, Open-circuit impedance: min. 100kΩ		
Measurement range		·Mode F1, F2, F7, F8, F9, F10 : 0.0005Hz to 50kHz ·Mode F3, F4, F5, F6 : 0.01 to max. of each time range ·Mode F11, F12, F13, F16 : 0 to 99999 ·Mode F14, F15 : -19999 to 99999		
Measurement accuracy(23±5°C)		·Mode F1, F2, F7, F8, F9, F10: F.S.±0.05%rdg±1digit ·Mode F3, F4, F5, F6: F.S.±0.01%rdg±1digit		
Display cycle		OFF (for F2, F16), 0.05, 0.5, 1, 2, 4, 8 sec (same as update output cycle)		
Operation mode		Frequency/Revolutions/Speed (F1), Passing speed (F2), Cycle (F3), Passing time (F4), Time interval (F5), Time differential (F6), Absolute ratio (F7), Error ratio (F8), Density (F9), Error (F10), Length measurement 1 (F11), Interval (F12), Accumulation (F13), Addition/Subtraction-individual input (F14), Addition/Subtraction-phase difference input (F15), Length measurement 2 (F16)		
Prescale function		Direct input method (0.0001×10 ⁻⁹ to 9.9999×10 ⁹)		
Hysteresis		0 to 9999 ※1		
Output	Main	Relay(triple)	250VAC 3A resistive load	
		Relay(quintuple)	—	250VAC 3A resistive load
		NPN/PNP open collector quintuple	—	Max. 30VDC 30mA
	Sub	BCD Dynamic	—	Max. 30VDC 30mA
		Analog	—	DC4-20mA/DC0-20mA max. load 500Ω
		Communication	—	RS485 communication output (Modbus RTU method)
Memory retention		Non-volatile memory (number of inputs: 100,000 operations)		
Insulation resistance		Min. 100MΩ (at 500VDC megger)		
Dielectric strength		2,000VAC 60Hz for 1min.		
Noise resistance		±2kV the square wave noise (pulse width: 1μs) by the noise simulator		
Vibration	Mechanical	0.75mm amplitude at frequency of 10 to 55Hz in each X, Y, Z direction for 1 hour		
	Malfunction	0.5mm amplitude at frequency of 10 to 55Hz in each X, Y, Z direction for 10 minutes		
Shock	Mechanical	300m/s ² (approx. 30G) in each X, Y, Z direction for 3 times		
	Malfunction	100m/s ² (approx. 30G) in each X, Y, Z direction for 3 times		
Relay life cycle	Mechanical	—	Min. 10,000,000 operations	
	Electrical	—	Min. 100,000 operations (250VAC 3A resistive load)	
Environment	Ambient temperature	-10 to 50°C, storage: -20 to 60°C		
	Ambient humidity	35 to 85%RH, storage: 35 to 85%RH		
Approval		CE c RU us		
Weight※2		Approx. 191g (approx. 132g)	Approx. 230g (approx. 140g)	Approx. 334g (approx. 210g)

※1: Setting range will vary depending on the decimal point.

※2: The weight includes packaging. The weight in parentheses is for unit only.

※Environment resistance is rated at no freezing or condensation.

(A) Photoelectric Sensors

(B) Fiber Optic Sensors

(C) Door/Area Sensors

(D) Proximity Sensors

(E) Pressure Sensors

(F) Rotary Encoders

(G) Connectors/ Connector Cables/ Sensor Distribution Boxes/ Sockets

(H) Temperature Controllers

(I) SSRs / Power Controllers

(J) Counters

(K) Timers

(L) Panel Meters

(M) Tacho / Speed / Pulse Meters

(N) Display Units

(O) Sensor Controllers

(P) Switching Mode Power Supplies

(Q) Stepper Motors & Drivers & Controllers

(R) Graphic/ Logic Panels

(S) Field Network Devices

(T) Software

MP5S/Y/W Series

■ Connections

※Terminal connections differ by power supply and output type of each series and model.

○ MP5S Series

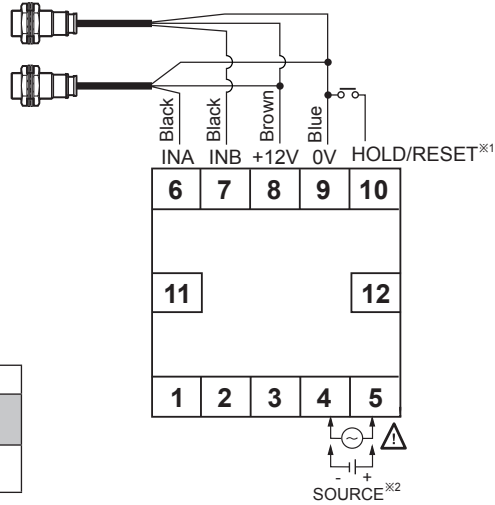

※1: Operation mode F1 to F12:
Display value HOLD
Operation mode F13 to F16:
Display value RESET

※2:

Model	Source
MP5S-2N	24-48VDC 24VAC 50/60Hz
MP5S-4N	100-240VAC 50/60Hz

○ MP5Y Series

● Power/Input Terminal (common)

※MP5Y-□N (indicator) only has 'Power/Input terminals'.

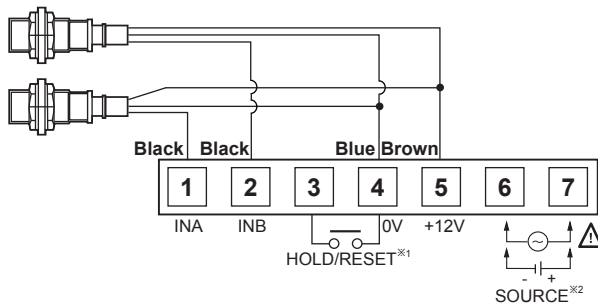

※1: Operation mode F1 to F12:
Display value HOLD
Operation mode F13 to F16:
Display value RESET

※2:

Model	Source
MP5Y-2□	24-48VDC 24VAC 50/60Hz
MP5Y-4□	100-240VAC 50/60Hz

● Output Connector (MP5Y-□1 to 5)

※Hirose connector: HIF3BA-10PA-2.54DS

※Hirose connector socket: HIF3BA-10D-2.54R (sold separately)

※Hirose connector socket is not included. Contact a hirose connector dealer regarding sockets and cables.

● MP5Y-□1 (NPN open collector output)

MAIN OUT (NPN OPEN COLLECTOR)
30VDC 30mA

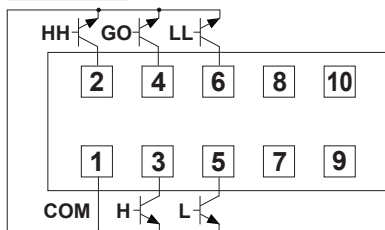

● MP5Y-□2 (PNP open collector output)

MAIN OUT (PNP OPEN COLLECTOR)
30VDC 30mA

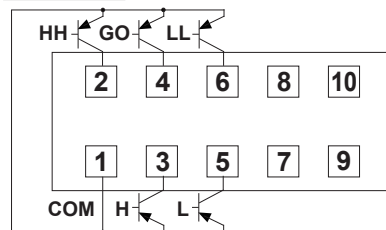

● MP5Y-□3(BCD Dynamic output)

BCD OUT(NPN OPEN COLLECTOR)
30VDC 30mA

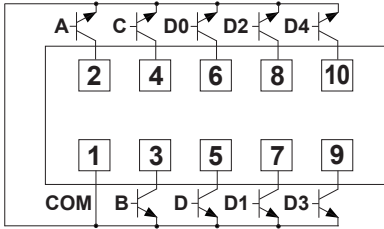

※Autonics display unit (DS/DA Series) is recommended for stable minus (-) sign display.

● MP5Y-□4(PV transmission output)

DC4-20mA/DC0-20mA
Load 500Ω Max.

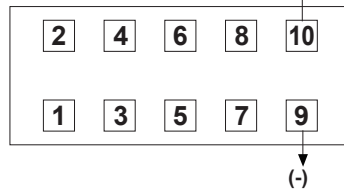

● MP5Y-□5(RS485 communication output)

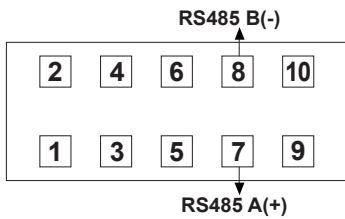

● Output Terminal (MP5Y-□6)

● MP5Y-□6(Relay triple output)

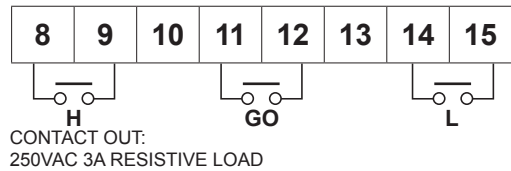

◎ MP5W Series

● Power/Input Terminal(common)

※MP5W-□N (indicator) only has 'Power/Input terminals'.

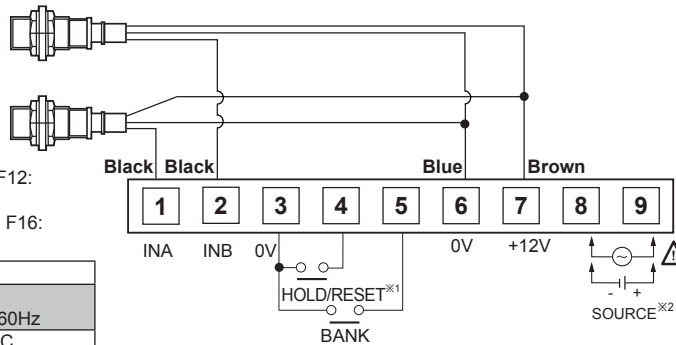

※1: Operation mode F1 to F12:
Display value HOLD
Operation mode F13 to F16:
Display value RESET

Model	Source
MP5W-2□	24-48VDC 24VAC 50/60Hz
MP5W-4□	100-240VAC 50/60Hz

● Output Terminal(MP5W-□1/2)

● MP5W-□A(Relay quintuple output)

CONTACT OUT:
250VAC 3A RESISTIVE LOAD

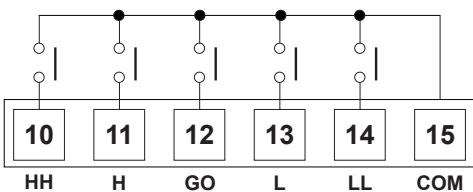

● MP5W-□1(Relay triple output)

CONTACT OUT:
250VAC 3A RESISTIVE LOAD

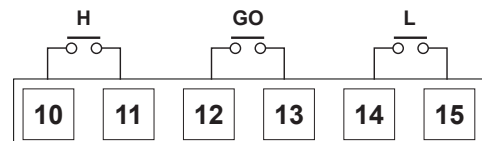

- (A) Photoelectric Sensors
- (B) Fiber Optic Sensors
- (C) Door/Area Sensors
- (D) Proximity Sensors
- (E) Pressure Sensors
- (F) Rotary Encoders
- (G) Connectors/ Connector Cables/ Sensor Distribution Boxes/ Sockets
- (H) Temperature Controllers
- (I) SSRs / Power Controllers
- (J) Counters
- (K) Timers
- (L) Panel Meters
- (M) Tacho / Speed / Pulse Meters
- (N) Display Units
- (O) Sensor Controllers
- (P) Switching Mode Power Supplies
- (Q) Stepper Motors & Drivers & Controllers
- (R) Graphic/ Logic Panels
- (S) Field Network Devices
- (T) Software

MP5S/Y/W Series

• Output Connector (MP5W-□2/4/5/8/9)

※Hirose connector: HIF3BA-20PA-2.54DS

※Hirose connector socket: HIF3BA-20D-2.54R(sold separately)

※Hirose connector socket is not included. Contact a hirose connector dealer regarding sockets and cables.

※1: Sub power supply

※2: POL signal turns ON when the display value is a minus (-) value.

• MP5W-□2(NPN open collector+BCD output)

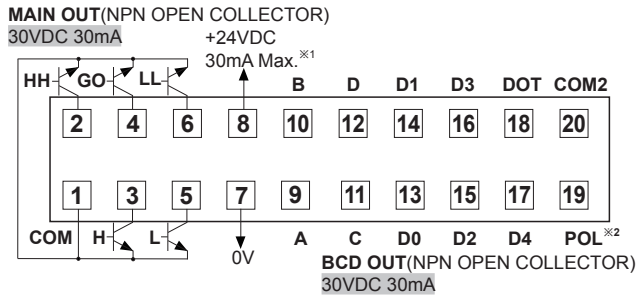

※Autonics display unit (DS/DA Series) is recommended for stable minus (-) sign display.

• MP5W-□4 (NPN open collector+PV transmission output)

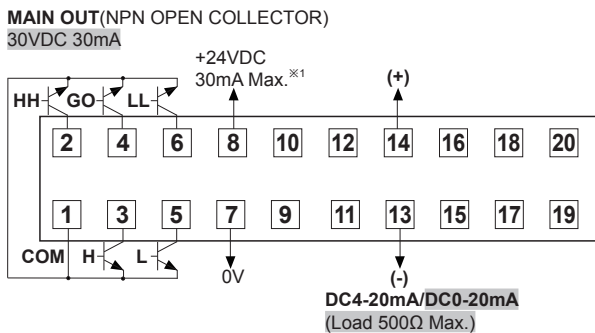

• MP5W-□5 (PNP open collector+PV transmission output)

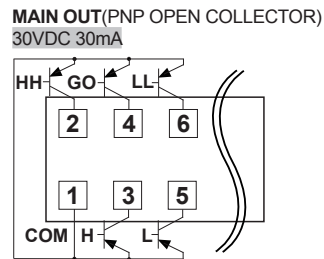

• MP5W-□8 (NPN open collector+RS485 com. output)

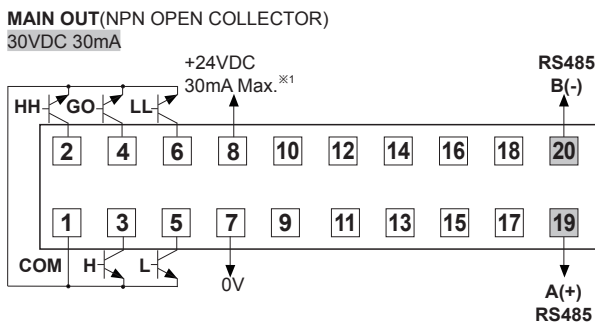

• MP5W-□9 (PNP open collector+RS485 com. output)

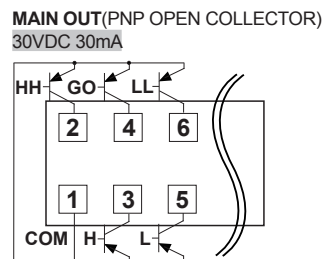

■ Dimensions

※Nameplate design is changed from the previous MP5.
 ※Side dimensions of MP5Y/W differ by output type.

(unit: mm)

●MP5S Series

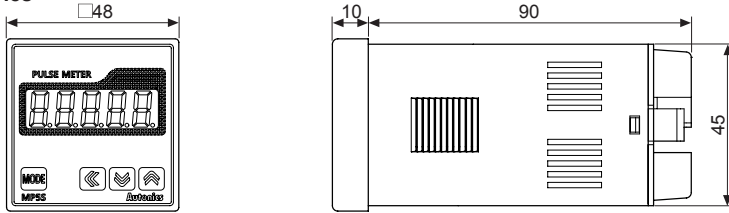

●MP5Y Series

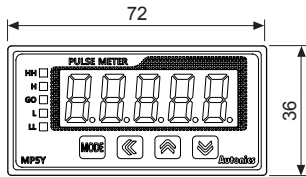

● MP5Y-□1/2/3/4/5

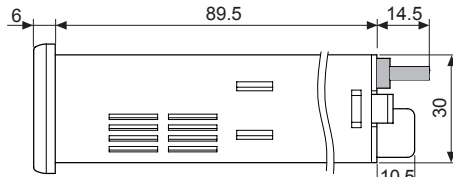

● MP5Y-□6

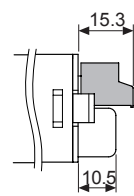

※MP5Y-□N (indicator) does not include the shaded part (output Hirose connector or output terminal).

●MP5W Series

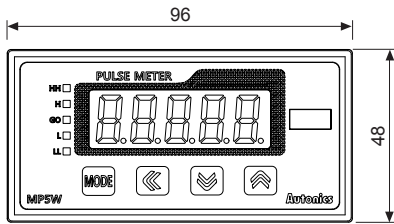

● MP5W-□2/4/5/8/9

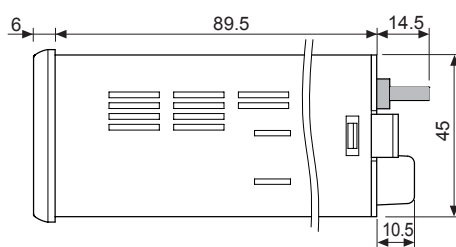

● MP5W-□A/1

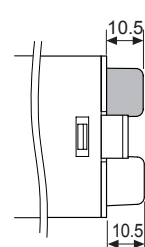

※MP5W-□N (indicator) does not include the shaded part (output Hirose connector or output terminal).

● Panel cut-out dimensions

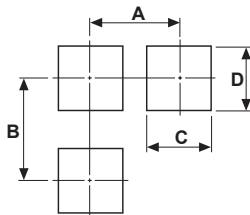

(unit: mm)

Series \ Size	A	B	C	D
MP5S	Min. 55	Min. 62	45.5 ^{+0.5}	45.5 ^{+0.5}
MP5Y	Min. 91	Min. 40	68 ^{+0.7}	31.5 ^{+0.5}
MP5W	Min. 116	Min. 52	92 ^{+0.8}	45 ^{+0.6}

●Bracket ● For MP5S

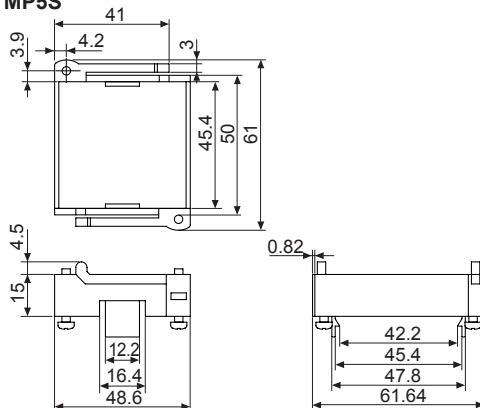

● For MP5Y/W

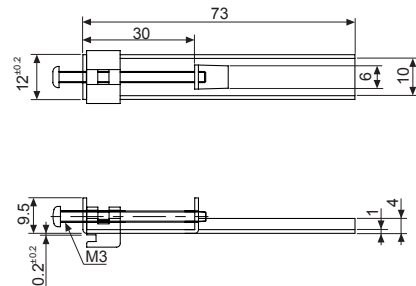

(A)	Photoelectric Sensors
(B)	Fiber Optic Sensors
(C)	Door/Area Sensors
(D)	Proximity Sensors
(E)	Pressure Sensors
(F)	Rotary Encoders
(G)	Connectors/ Connector Cables/ Sensor Distribution Boxes/ Sockets
(H)	Temperature Controllers
(I)	SSRs / Power Controllers
(J)	Counters
(K)	Timers
(L)	Panel Meters
(M)	Tacho / Speed / Pulse Meters
(N)	Display Units
(O)	Sensor Controllers
(P)	Switching Mode Power Supplies
(Q)	Stepper Motors & Drivers & Controllers
(R)	Graphic/ Logic Panels
(S)	Field Network Devices
(T)	Software

MP5S/Y/W Series

Unit Description

•MP5S

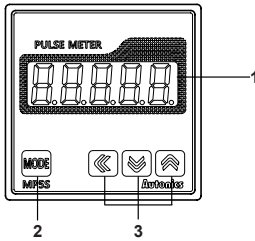

•MP5Y

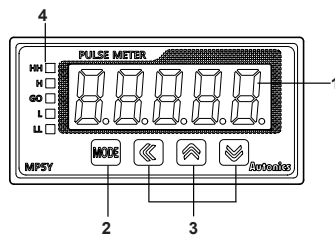

•MP5W

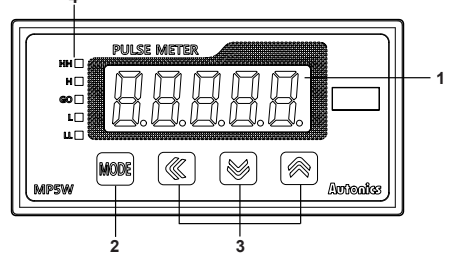

1: Display component

Displays current value in RUN mode.

Alternately displays setting parameters and corresponding value in SETTING mode.

2: MODE key

In RUN mode, press the key once to check max./min. value.

In RUN mode, hold the key for over 2 sec to enter parameter groups.

3: Navigation keys

Select parameter groups, and select or setting values in the corresponding parameters.

4: Output status indicator

Sold Separately

Communication converter

•SCM-38I

(RS232C to RS485 converter)



•SCM-US48I

(USB to RS485 converter)



Display Units (DS/DA-T Series)

•DS/DA-T Series

(RS485 communication input type display unit) CE



DS16-□T



DS22/DA22-□T



DS40/DA40-□T



DS60/DA60-□T

※Connect RS485 communication input type display unit (DS/DA-T Series) and RS485 communication output model of MP5Y/MP5W Series, the display unit displays present value of the device without PC/PLC.

Input Specifications

Input Specifications

1. Input signal

(1) Solid state input

① Input frequency: max. 50kHz (standard duty ratio of input signal: 1: 1, ON/OFF pulse width: Min. 10μs of each)

② Input voltage level: ON voltage → 4.5-24V, OFF voltage → 0-1.0V

(2) Contact input

① Input frequency: Max. 45Hz (when each ON/OFF pulse width is over 11ms)

② Contact specifications: 12VDC, stable switching of load current as small as 5mA

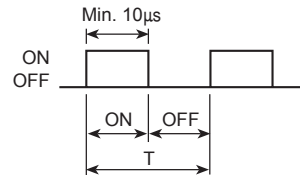

※T: single cycle of input signal

2. Input type [i n - A, i n - b]

MP5 allows selection between NPN input (solid state/contact) or PNP input (solid state/contact).

(1) NPN input type

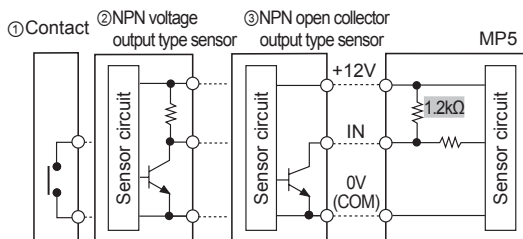

(2) PNP input type

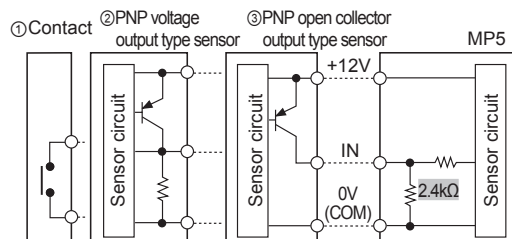

Output Specifications

1. Relay output

- ① Output: Comparative or alarm output (refer to "Output mode")
- ② Output type: Relay
- ③ Contact capacity: 250VAC 3A resistive load
- ④ Life cycle: [Mechanical] min. 10,000,000 operations (switching frequency 180 operations/min.)
[Electrical] min. 100,000 operations (3A 250VAC, 30VDC resistive load) (switching frequency 20 operations/min.)

2. Transistor output

- ① Output: Comparative output or alarm output (refer to "Output mode")
- ② Output type: NPN/PNP open collector
- ③ Rated load voltage: 30VDC
- ④ Max. load current: 30mA

3. BCD dynamic output(negative logic)

- ① Output: present value
- ② Output signal: BCD data (A, B, C, D, DOT)
← A: lowest bit, DOT: highest bit
Digit data (D0, D1, D2, D3, D4)
← D0: lowest digit, D4: highest digit
- ③ Output type: NPN open collector
- ④ Rated load voltage: 30VDC
- ⑤ Max. load current: 30mA
- ⑥ Dynamic COM cycle (T) = 39ms

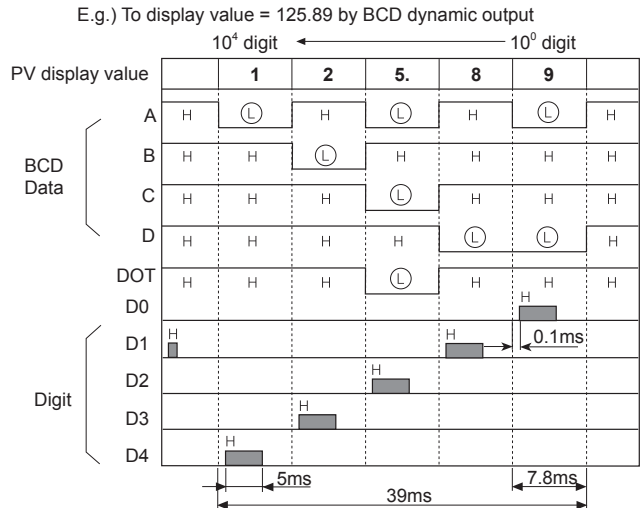

4. PV transmission output

- ① Application: transmit measured value
- ② Function: transmit measured value within setting range of high-limit output [F5-H] to low-limit output [F5-L] after conversion into DC4-20mA or DC0-20mA current.

③ Output range of high/low-limit

- High-limit [F5-H] range: From min. value to max. value within measurement range
- Low-limit [F5-L] range: From min. value to max. value within measurement range ($[F5-H] \geq [F5-L] + 1$)

(1) DC4-20mA transmission output

- ① Transmit measured value within setting range of high-limit output [F5-H] to low-limit output [F5-L] after conversion into DC4-20mA current.
- ② Resistive load: Max. 500Ω
- ③ Resolution: 8000 divisions

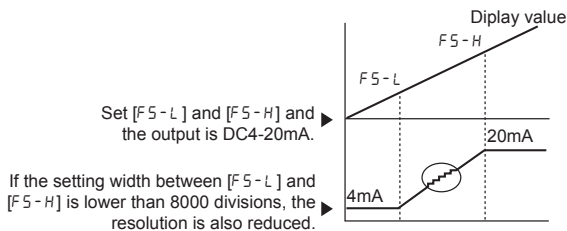

(2) DC0-20mA transmission output

- ① Transmit measured value within setting range of high-limit output [F5-H] to low-limit output [F5-L] after conversion into DC0-20mA current.
- ② Resistive load: Max. 500Ω
- ③ Resolution: 10,000 divisions

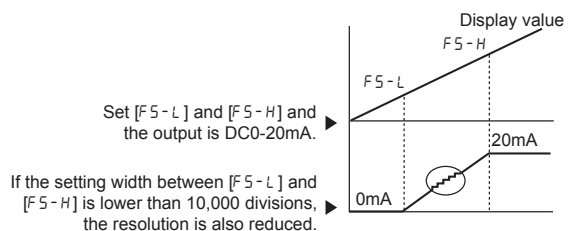

5. RS485 communication output

Comm. protocol	Modbus RTU	Communication Speed	2400, 4800, 9600 (default), 19200, 38400 bps
Connection type	RS485	Communication response time	5 to 99ms (default: 20ms)
Application standard	Compliance with EIA RS485	Start Bit	1-bit fixed
Max. connection	31 units (address: 01 to 99)	Data Bit	8-bit fixed
Synchronous method	Asynchronous	Parity Bit	None (default), Even, Odd
Comm. method	Two-wire half duplex	Stop Bit	1, 2-bit (default)
Comm. distance	Max. 800m		

※ For more information about RS485 communication output specifications, refer to 'RS485 communication output'.

(A) Photoelectric Sensors

(B) Fiber Optic Sensors

(C) Door/Area Sensors

(D) Proximity Sensors

(E) Pressure Sensors

(F) Rotary Encoders

(G) Connectors/ Connector Cables/ Sensor Distribution Boxes/ Sockets

(H) Temperature Controllers

(I) SSRs / Power Controllers

(J) Counters

(K) Timers

(L) Panel Meters

(M) Tacho / Speed / Pulse Meters

(N) Display Units

(O) Sensor Controllers

(P) Switching Mode Power Supplies

(Q) Stepper Motors & Drivers & Controllers

(R) Graphic/ Logic Panels

(S) Field Network Devices

(T) Software

MP5S/Y/W Series

Parameter Groups

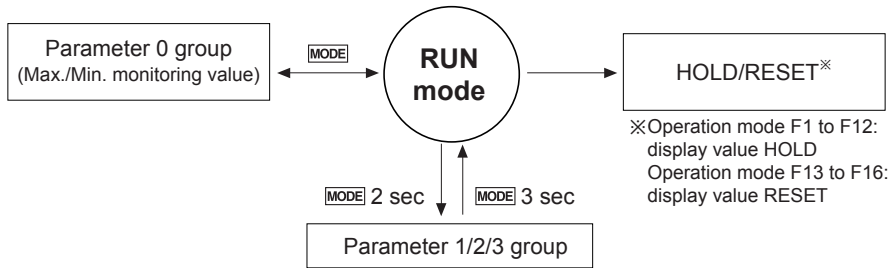

- ※ Press the \leftarrow , \uparrow , \downarrow , \rightarrow keys to select or set the desired value.
- ※ Press the **MODE** key once after changing the setting value, to save the setting value and move to the next parameter.
- ※ Hold the **MODE** key for 1.5 sec at any parameters to return to the select parameter group mode.
- ※ Hold the **MODE** key for 3 sec to save the setting value and return to RUN mode after changing the setting value.
- ※ If there is no key input for 60 sec while setting the parameters, the new settings are ignored, and the unit will return to RUN mode with previous settings.
- ※ The dotted line parameters may not appear depending on output specifications or other parameter settings. Please refer to 'Operation mode by parameter group'.
- ※ 1: Each parameter and corresponding setting value will flash alternately every 0.5 sec

Parameter 0 group

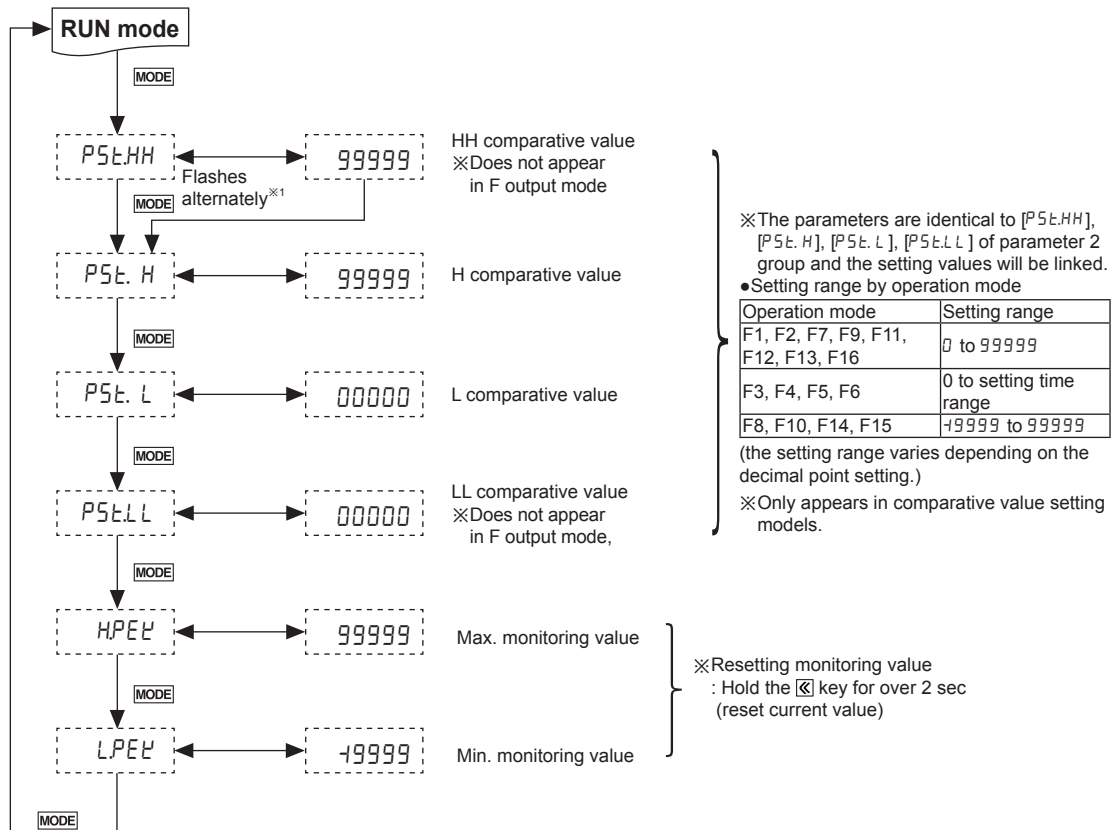

Parameter 1 group

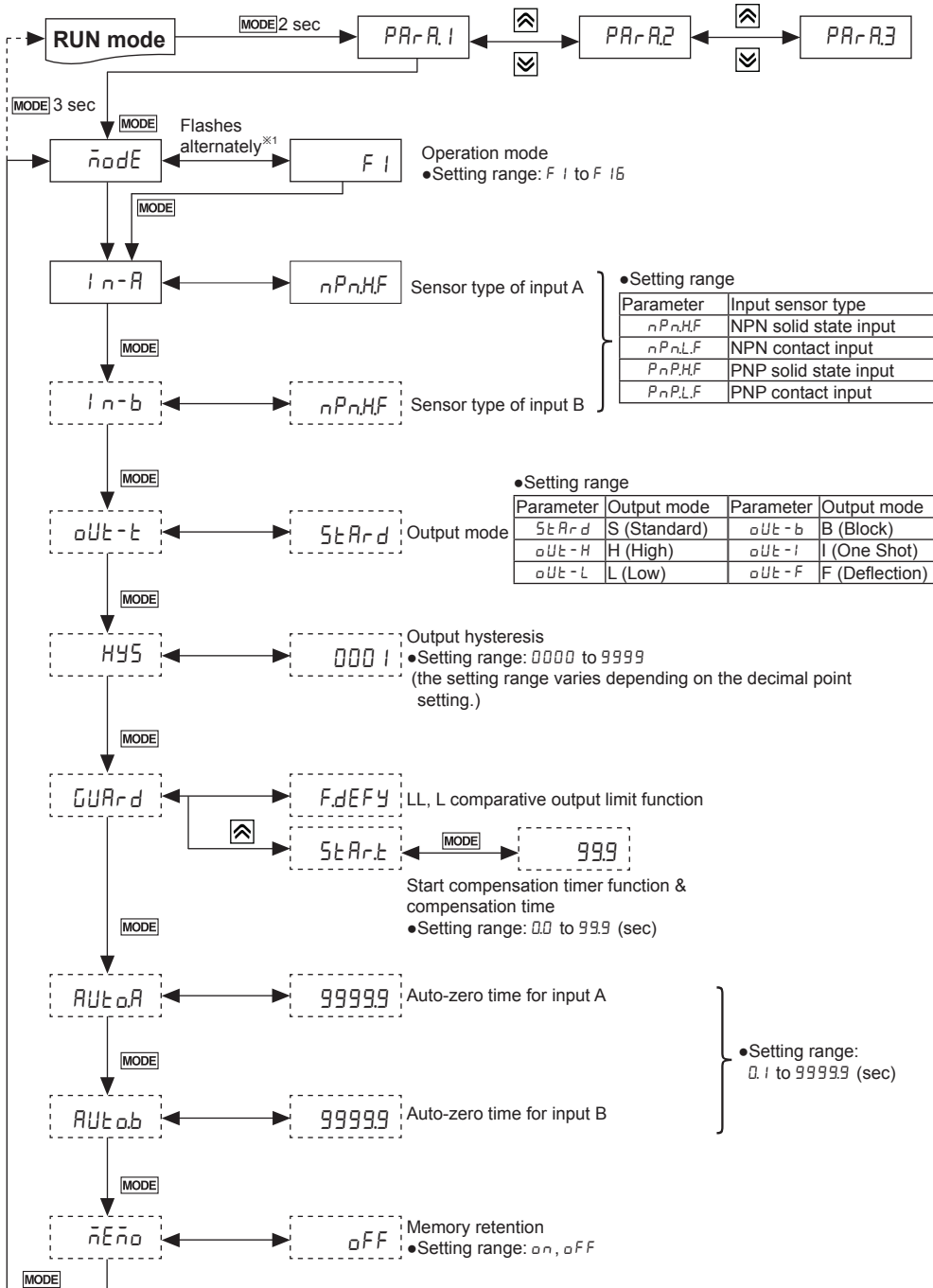

※Does not appear in indicator models.

(A)	Photoelectric Sensors
(B)	Fiber Optic Sensors
(C)	Door/Area Sensors
(D)	Proximity Sensors
(E)	Pressure Sensors
(F)	Rotary Encoders
(G)	Connectors/ Connector Cables/ Sensor Distribution Boxes/ Sockets
(H)	Temperature Controllers
(I)	SSRs / Power Controllers
(J)	Counters
(K)	Timers
(L)	Panel Meters
(M)	Tacho / Speed / Pulse Meters
(N)	Display Units
(O)	Sensor Controllers
(P)	Switching Mode Power Supplies
(Q)	Stepper Motors & Drivers & Controllers
(R)	Graphic/ Logic Panels
(S)	Field Network Devices
(T)	Software

MP5S/Y/W Series

Parameter 2 group

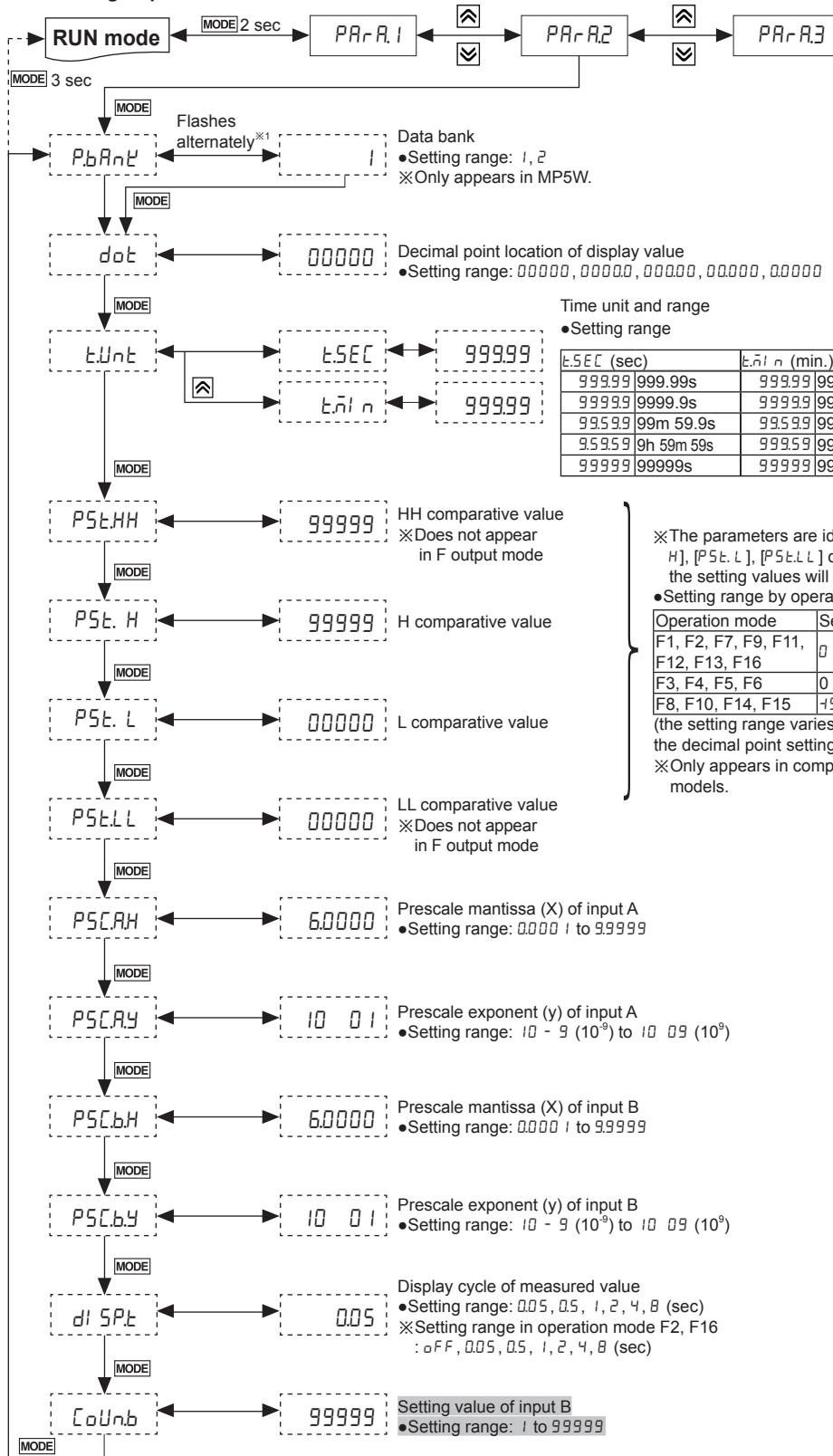

※The parameters are identical to [PSt.HH], [PSt.H], [PSt.L], [PSt.LL] of parameter 0 group and the setting values will be linked.

●Setting range by operation mode

Operation mode	Setting range
F1, F2, F7, F9, F11, F12, F13, F16	0 to 99999
F3, F4, F5, F6	0 to set time range
F8, F10, F14, F15	19999 to 99999

(the setting range varies depending on the decimal point setting.)

※Only appears in comparative value setting models.

Parameter 3 group

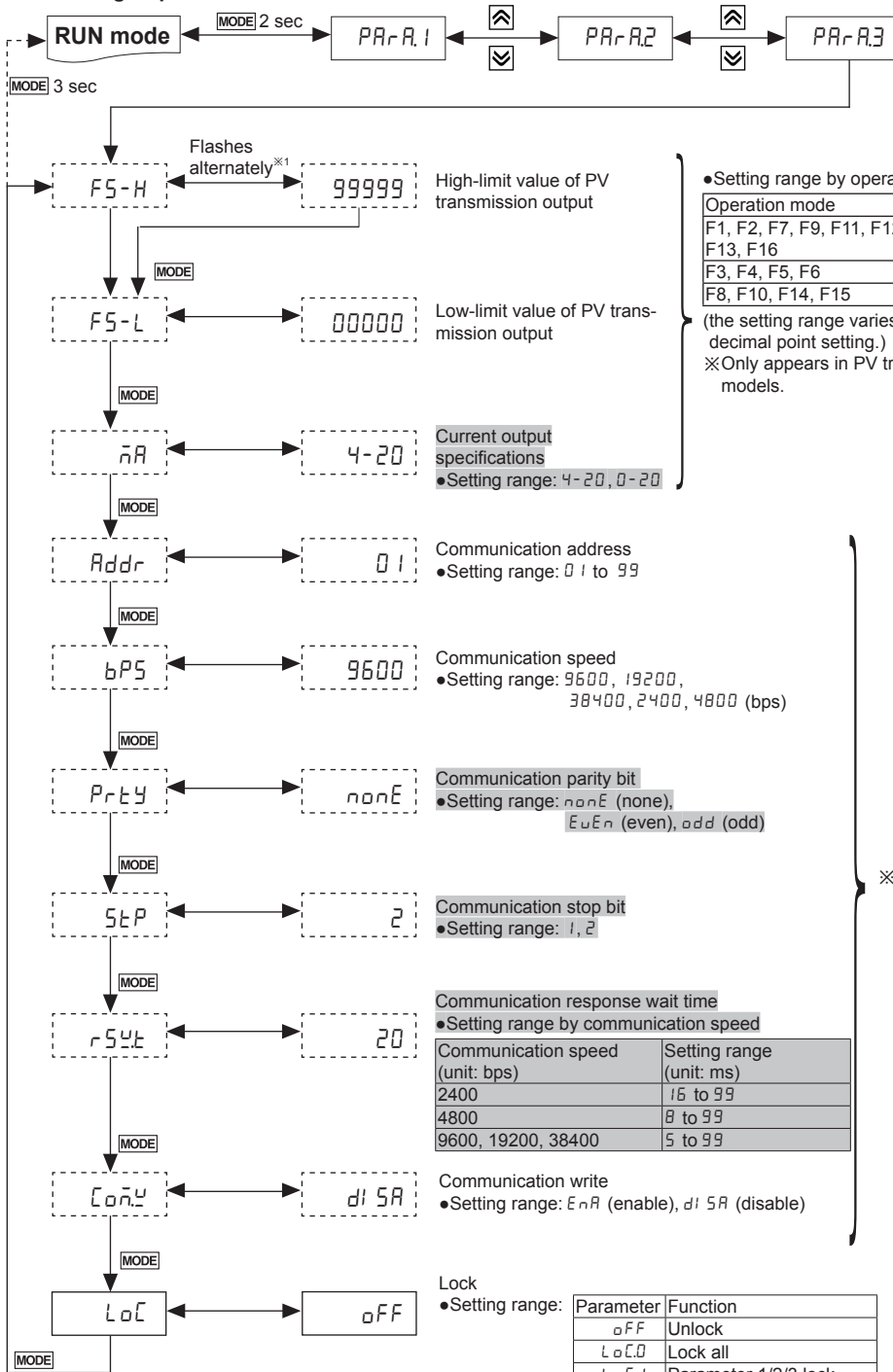

Setting range by operation mode

Operation mode	Setting range
F1, F2, F7, F9, F11, F12, F13, F16	0 to 99999
F3, F4, F5, F6	0 to set time range
F8, F10, F14, F15	±9999 to 99999

(the setting range varies depending on the decimal point setting.)

※ Only appears in PV transmission output models.

※ Only appears in RS485 output models.

(A)	Photoelectric Sensors
(B)	Fiber Optic Sensors
(C)	Door/Area Sensors
(D)	Proximity Sensors
(E)	Pressure Sensors
(F)	Rotary Encoders
(G)	Connectors/ Connector Cables/ Sensor Distribution Boxes/ Sockets
(H)	Temperature Controllers
(I)	SSRs / Power Controllers
(J)	Counters
(K)	Timers
(L)	Panel Meters
(M)	Tacho / Speed / Pulse Meters
(N)	Display Units
(O)	Sensor Controllers
(P)	Switching Mode Power Supplies
(Q)	Stepper Motors & Drivers & Controllers
(R)	Graphic/ Logic Panels
(S)	Field Network Devices
(T)	Software

MP5S/Y/W Series

■ Operation Mode By Parameter Groups

(●: parameter display, X: no parameter display)

Operation mode		F1	F2	F3	F4	F5	F6	F7	F8	F9	F10	F11	F12	F13	F14	F15	F16	
0 group	P5tHH※1	Appears in all operation modes (F1 to F16).																
	P5t.H※2	Appears in all operation modes (F1 to F16).																
	P5t.L※2	Appears in all operation modes (F1 to F16).																
	P5t.LL※1	Appears in all operation modes (F1 to F16).																
	HPEL	●	●	●	●	●	●	●	●	●	●	●	●	X	●	●	X	
	LPEL	●	●	●	●	●	●	●	●	●	●	●	●	X	●	●	X	
1 group	nodE	Appears in all operation mode (F1 to F16).																
	ln-R	Appears in all operation mode (F1 to F16).																
	ln-b	X	●	X	X	X	●	●	●	●	●	●	○※3	○	○	●	X※4	●※5
	out-t※2	●	●	●	●	●	●	●	●	●	●	●	●	●	X	●	●	●※5
	HYS※2	●	X	X	X	X	X	●	●	●	●	●	X	X	X	X	X	X
	Currd※2	●	●	●	●	●	●	●	●	●	●	●	●	●	X	X	X	X
	AutαR	●	X	X	●	X	X	●	●	●	●	●	X	X	X	X	X	X
	Autαb	X	X	X	X	X	X	●	●	●	●	●	X	X	X	X	X	X
nEno	X	X	X	X	X	X	X	X	X	X	X	X	X	●	●	●	●	
2 group	PbRnL	※Only appears in MP5W. Appears in all operation modes (F1 to F16).																
	dot	●	●	X	X	X	X	●	●	●	●	●	●	●	●	●	●	
	tUnb	X	X	●	●	●	●	X	X	X	X	X	X	X	X	X	X	
	P5tHH※1	Appears in all operation modes (F1 to F16).																
	P5t.H※2	Appears in all operation modes (F1 to F16).																
	P5tLL※2	Appears in all operation modes (F1 to F16).																
	P5t.L※1	Appears in all operation modes (F1 to F16).																
	P5CRH	●	●	X	●	X	X	●	●	●	●	●	●	●	●	●	●	●
	P5CRY	●	●	X	●	X	X	●	●	●	●	●	●	●	●	●	●	●
	P5CbH	X	X	X	X	X	X	●	●	●	●	●	X	X	X	X	X	X
	P5CbY	X	X	X	X	X	X	●	●	●	●	●	X	X	X	X	X	X
diSPt	●	■※6	X	X	X	X	●	●	●	●	●	X	X	X	X	X	■	
CoUnb	X	X	X	X	X	X	X	X	X	X	X	X	X	X	X	X	●	
3 group	F5-H	※Only appears in PV transmission output models. Appears in operation modes (F1 to F16).																
	F5-L	※Only appears in PV transmission output models. Appears in operation modes (F1 to F16).																
	nR	※Only appears in PV transmission output models. Appears in operation modes (F1 to F16).																
	Addr	※Only appears in RS485 output models. Appears in all operation modes (F1 to F16).																
	bPS	※Only appears in RS485 output models. Appears in all operation modes (F1 to F16).																
	PrtY	※Only appears in RS485 output models. Appears in all operation modes (F1 to F16).																
	StP	※Only appears in RS485 output models. Appears in all operation modes (F1 to F16).																
	rEYt	※Only appears in RS485 output models. Appears in all operation modes (F1 to F16).																
	CoYt	※Only appears in RS485 output models. Appears in all operation modes (F1 to F16).																
LoC	●	●	●	●	●	●	●	●	●	●	●	●	●	●	●	●	●	

- ※1: Only appears in only for quintuple output models.
- ※2: Only appears in triple, quintuple output models.
- ※3: (○) Only nPnHF or PnPHF setting are available for input B sensor type.
- ※4: The settings for ln-b and ln-R are applied.
- ※5: (●) F output mode[out-F] cannot be set.
- ※6: (■) setting range: αFF, 0.05, 0.5, 1, 2, 4, 8

• Monitoring delay function by output mode

Output mode	S mode	H mode	L mode	B mode	I mode	F mode
Parameter	StRrd	out-h	out-L	out-b	out-I	out-F
Comparative output limit	●	X	X	●	X	●
Start compensation timer	●	●	●	●	●	●

■ Operation Modes [r o d E]

- Select operation mode from operation mode[r o d E] of parameter 1 group..
- MP5 has 16 operation modes.

○ F1 Mode: Frequency/Revolutions/Speed

Measures the frequency of input A and displays the calculated frequency, revolutions, and speed.

1) Frequency(Hz)	= $f \times \alpha$	($\alpha = 1[\text{sec}]$)
2) Revolutions(rpm)	= $f \times \alpha$	($\alpha = 60[\text{sec}]$)
3) Speed(m/min)	= $f \times \alpha$	($\alpha = 60L[\text{sec}]$)

※L: travel distance of conveyor belt of 1 pulse cycle[m]
 α : prescale value

For multiple objects, $\alpha = \frac{60L}{N}$

• Display value and display unit

Display value	Display unit	α (prescale value)
Frequency	Hz	1
	kHz	0.001
Revolutions	rps	1
	rpm (default)	60
Speed	mm/sec	1,000L
	cm/sec	100L
	m/sec	1L
	m/min	60L
	km/hour	3.6L

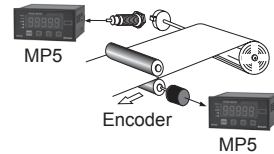

• Timing chart

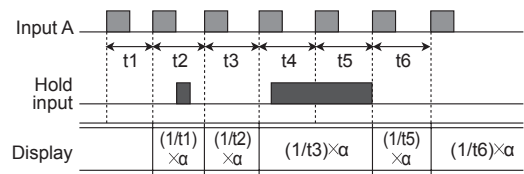

○ F2 Mode: Passing Speed

Displays the passing speed between input A ON and input B ON.

Passing speed (V) = $f \times \alpha$ ($\alpha = L[\text{m}]$)

※f: reciprocal of time [sec] between input A (sensor) ON and input B (sensor) ON.

L: distance between input A (sensor) and input B (sensor) [m]
 α : prescale value

• Display value and display unit

Display value	Display unit	α (prescale value)
Passing speed	mm/sec	1,000L
	cm/sec	100L
	m/sec(default)	1L
	m/min	60L
	km/hour	3.6L

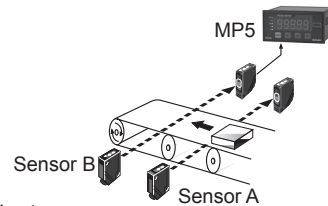

• Timing chart

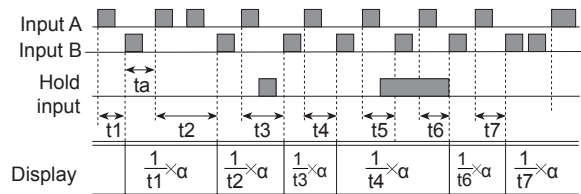

※ta: Return time(over 20ms)

○ F3 Mode: Cycle

Displays the measured time from Input A ON to the next ON.

Cycle(T) = t ※t: measurement time[sec]

• Display value and display unit ([t. U n t] of parameter 2)

Display value	Display unit	Min.
Cycle	Sec	Min.
	999.99s (default)	999.99m
	9999.9s	9999.9m
	99m59.9s	99h59.9m
	9h59m59s	999h59m
	99999s	99999m

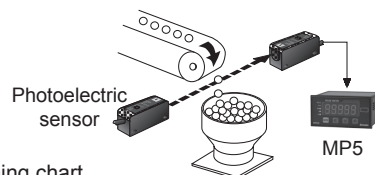

• Timing chart

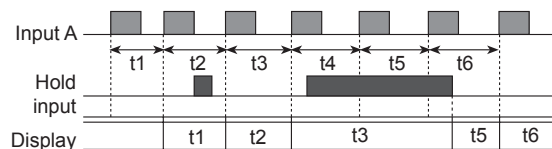

(A) Photoelectric Sensors

(B) Fiber Optic Sensors

(C) Door/Area Sensors

(D) Proximity Sensors

(E) Pressure Sensors

(F) Rotary Encoders

(G) Connectors/ Connector Cables/ Sensor Distribution Boxes/ Sockets

(H) Temperature Controllers

(I) SSRs / Power Controllers

(J) Counters

(K) Timers

(L) Panel Meters

(M) Tacho / Speed / Pulse Meters

(N) Display Units

(O) Sensor Controllers

(P) Switching Mode Power Supplies

(Q) Stepper Motors & Drivers & Controllers

(R) Graphic/ Logic Panels

(S) Field Network Devices

(T) Software

MP5S/Y/W Series

◎ F4 Mode: Passing Time

Measures the time from Input A ON to the next ON, and displays the passing time of the arbitrary distance.

$$\text{Passing time[sec]} = t \times \alpha$$

$$\left(\alpha = \frac{L[\text{m}]}{\text{Distance advanced in 1 pulse cycle [m]}} \right)$$

※t : measured time[sec], L : arbitrary distance[m]
 α : prescale value

• Display value and display unit ([Unit] of parameter 2)

Display value	Display unit	
Passing time	Sec	Min.
	999.99s (default)	999.99m
	9999.9s	9999.9m
	99m59.9s	99h59.9m
	9h59m59s	999h59m
	99999s	99999m

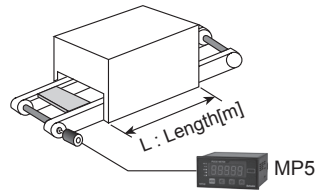

• Timing chart

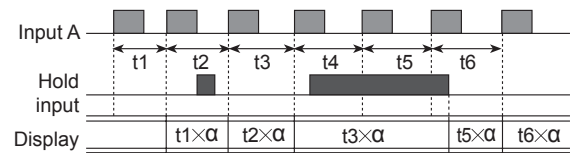

◎ F5 Mode: Time Interval

Displays measured time of Input A ON

$$\text{Time interval}(T) = t$$

※t : measured time of input A ON [sec]

• Display value and display unit ([Unit] of parameter 2)

Display value	Display unit	
Time interval	Sec	Min.
	999.99s (default)	999.99m
	9999.9s	9999.9m
	99m59.9s	99h59.9m
	9h59m59s	999h59m
	99999s	99999m

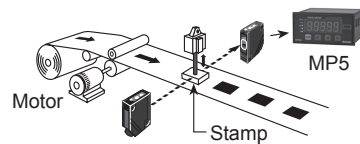

• Timing chart

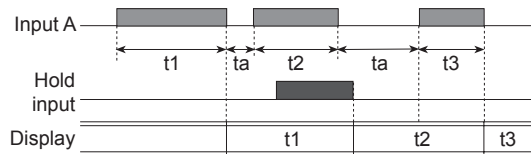

※ta: Return time(over 20ms)

◎ F6 Mode: Time Differential

Displays measured time from Input A ON to Input B ON.

$$\text{Time differential}(T) = t(\text{ta to tb})$$

※t(ta to tb): measured time from input A ON to input B ON [sec]

• Display value and display unit ([Unit] of parameter 2)

Display value	Display unit	
Time difference	Sec	Min.
	999.99s (default)	999.99m
	9999.9s	9999.9m
	99m59.9s	99h59.9m
	9h59m59s	999h59m
	99999s	99999m

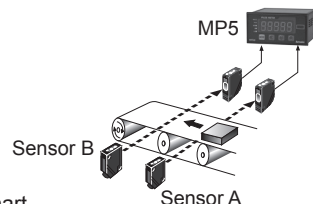

• Timing chart

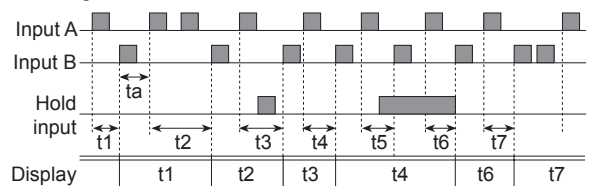

※ta: Return time(over 20ms)

◎ F7 Mode: Absolute Ratio

Measures and displays relative speed, amount, speed, etc. of input B against input A in percentage (%).

$$\text{Absolute ratio} = (\text{Input B} / \text{Input A}) \times 100\%$$

$$\text{Absolute ratio} = \frac{\text{Frequency of input B}[\text{Hz}] \times \text{Ba}}{\text{Frequency of input A}[\text{Hz}] \times \text{Aa}} \times 100[\%]$$

※Aa: Prescale value of input A, Ba: Prescale value of input B

• Display value and display unit

Display value	Display unit
Absolute ratio	%

※Hold: When the hold signal turns ON, the display value is maintained until the display cycle turns to hold OFF.

◎ F8 Mode: Error Ratio

Measures and displays the relative rate of input B against the reference value of input A in percentage(%).

$$\text{Error ratio} = \frac{\text{Input B} - \text{Input A}}{\text{Input A}} \times 100[\%]$$

$$\text{Error ratio} = \frac{(\text{Frequency of input B}[\text{Hz}] \times \text{Ba}) - (\text{Frequency of input A}[\text{Hz}] \times \text{Aa})}{\text{Frequency of input A}[\text{Hz}] \times \text{Aa}} \times 100[\%]$$

※Aa: prescale value of input A, Ba: prescale value of input B

• Display value and display unit

Display value	Display unit
Error ratio	%

※Hold: When the hold signal turns ON, the display value is maintained until the display cycle turns to hold OFF.

◎ F9 Mode: Density

Measures and displays the density ratio (%) of input B against the total sum of input A and input B.

$$\text{Density} = \frac{\text{Input B}}{\text{Input A} + \text{Input B}} \times 100[\%]$$

$$\text{Density} = \frac{\text{Frequency of Input B}[\text{Hz}] \times \text{Ba}}{(\text{Frequency of input A}[\text{Hz}] \times \text{Aa}) + (\text{Frequency of input B}[\text{Hz}] \times \text{Ba})} \times 100[\%]$$

※Aa: Prescale value of input A, Ba: Prescale value of input B

• Display value and display unit

Display value	Display unit
Density	%

※Hold: When the hold signal turns ON, the display value is maintained until the display cycle turns to hold OFF.

◎ F10 Mode: Error

Measures and displays the error of input B against reference value of input A.

$$\text{Error} = \text{Input B} - \text{Input A}$$

$$\text{Error} = (\text{Frequency of input B}[\text{Hz}] \times \text{Ba}) - (\text{Frequency of input A}[\text{Hz}] \times \text{Aa})$$

※Aa: prescale value of input A, Ba: prescale value of input B

• Display value and display unit

Display value	Display unit
Error	END User setting

※Hold: When the hold signal turns ON, the display value is maintained until the display cycle turns to hold OFF.

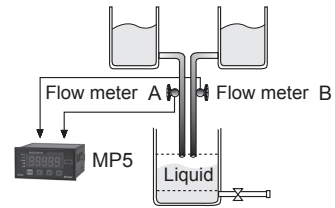

• Timing chart

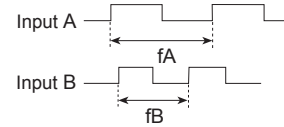

$$\text{Display} = \frac{\text{Frequency of input B}[\text{Hz}] \times \text{Ba}}{\text{Frequency of input A}[\text{Hz}] \times \text{Aa}} \times 100[\%]$$

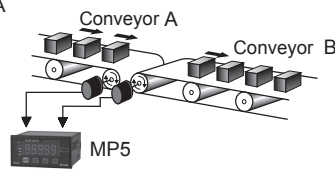

• Timing chart

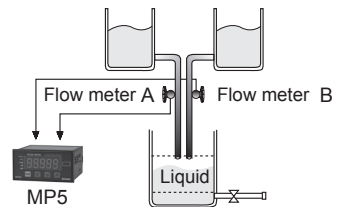
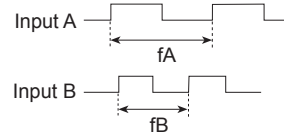

• Timing chart

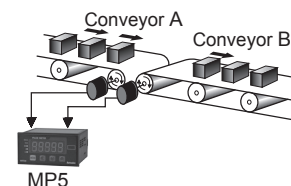
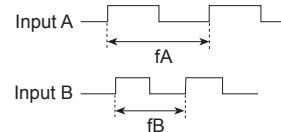

• Timing chart

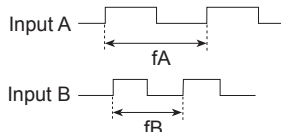

(A) Photoelectric Sensors

(B) Fiber Optic Sensors

(C) Door/Area Sensors

(D) Proximity Sensors

(E) Pressure Sensors

(F) Rotary Encoders

(G) Connectors/ Connector Cables/ Sensor Distribution Boxes/ Sockets

(H) Temperature Controllers

(I) SSRs / Power Controllers

(J) Counters

(K) Timers

(L) Panel Meters

(M) Tacho / Speed / Pulse Meters

(N) Display Units

(O) Sensor Controllers

(P) Switching Mode Power Supplies

(Q) Stepper Motors & Drivers & Controllers

(R) Graphic/ Logic Panels

(S) Field Network Devices

(T) Software

MP5S/Y/W Series

◎ F11 Mode: Length Measurement 1

Measure and display the number of input A pulses during input B ON.

$$\text{Length measurement} = P \times \alpha$$

※P: Number of input A pulses, α : Prescale value

• Display value and display unit

Display value	Display unit
Length measurement	Quantity(default)
	mm
	cm
	m

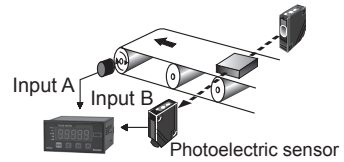

• Timing chart MP5

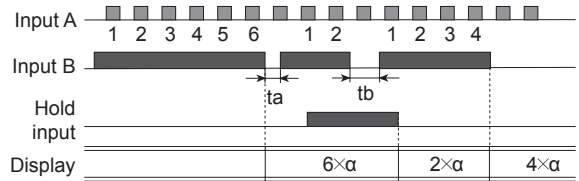

※ta, tb: return time(over 20ms)

◎ F12 Mode: Interval

Measures and displays the number of input A pulses from Input B ON to the next ON.

$$\text{Interval} = P \times \alpha$$

※P: Number of input A pulses, α : Prescale value

• Display value and display unit

Display value	Display unit
Interval	Quantity(default)
	mm
	cm
	m

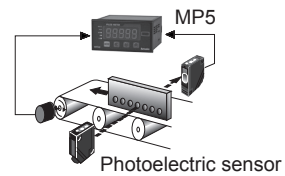

• Timing chart

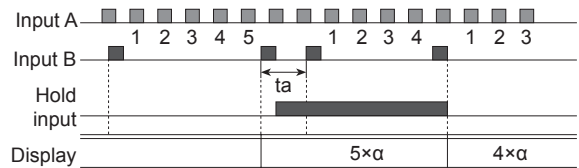

※ta: return time(over 20ms)

◎ F13 Mode: Accumulation

Measures and displays the counted value of input A pulses.

$$\text{Accumulation} = P \times \alpha$$

※P: Number of input A pulses, α : Prescale value

• Display value and display unit

Display value	Display unit
Accumulation	Quantity[EA]

• Operation

- ① Counts the number of input A pulses.
- ② Input B is an enable input signal. During ON, the quantity and display value of input A will be held, and during OFF input A will be re-counted.
- ③ When RESET input is ON, the integrated counted value will be reset to "0".

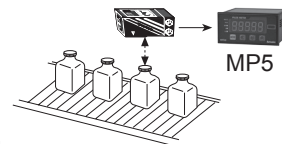

• Timing chart

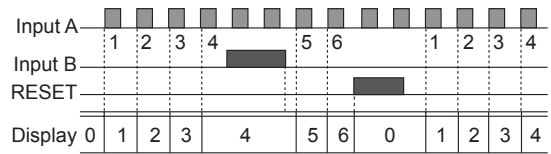

※ $\alpha=1$ display value

○ F14 Mode: Addition/Subtraction-Individual Input

Displays the counted value from added input A pulses and subtracted input B pulses. When there are two inputs simultaneously, it will not count.

$$\text{Addition/Subtraction} = \text{Input A} \times \alpha - \text{Input B} \times \beta$$

※ α : Prescale value of input A, β : Prescale value of input B

• Display value and display unit

Display value	Display unit
Addition/ Subtraction (individual input)	Quantity

• Operation and timing chart

Pulse of input A is added, and pulse of input B is subtracted.

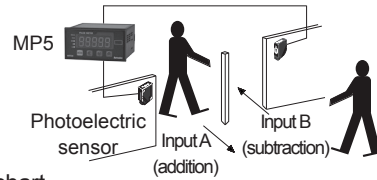

• Timing chart

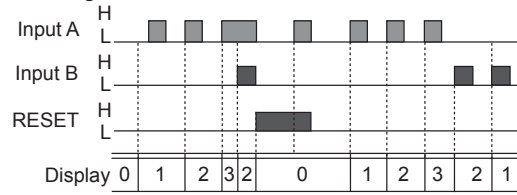

※ $\alpha, \beta=1$ display value

○ F15 Mode: Addition/Subtraction- Phase difference input

When input A is low, counting is added to the low of input B. When input A is low, counting is subtracted from the high of input B.

Addition/Subtraction(phase difference)
= Detects position and speed using A and B phases of encoder outputs as input.

• Display value and display unit

Display value	Display unit
Up/Down counting (phase difference input)	Quantity

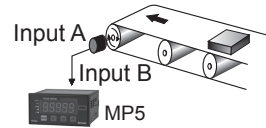

• Timing chart

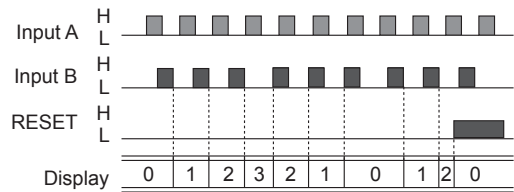

○ F16 Mode: Length Measurement 2

Measures and displays the number of pulses from input A until the value of input B reaches the set value.

$$\text{Length measurement 2} = P \times \alpha \text{ (until the setting value of Input B)}$$

※P: Number of input A pulses, α : Prescale value

• Display value and display unit

Display value	Display unit
Length measurement 2	Quantity[EA]

※If input A and input B are ON during initial power supply, it will not count and only count the number of rising edge.

※Display value is renewed depending on the display cycle [d: 5P.L.] setting.

• Timing chart (e.g.) setting value of Input B=4

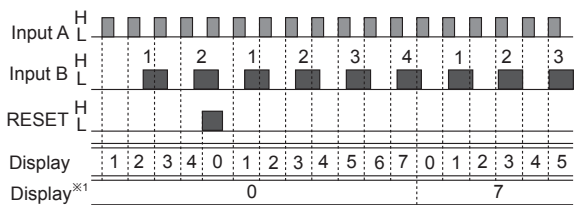

※1: When the display cycle[d: 5P.L.] setting is OFF, it will maintain the quantity of input A until the value of input B reaches the setting value B[Count].

(A) Photoelectric Sensors
(B) Fiber Optic Sensors
(C) Door/Area Sensors
(D) Proximity Sensors
(E) Pressure Sensors
(F) Rotary Encoders
(G) Connectors/ Connector Cables/ Sensor Distribution Boxes/ Sockets
(H) Temperature Controllers
(I) SSRs / Power Controllers
(J) Counters
(K) Timers
(L) Panel Meters
(M) Tacho / Speed / Pulse Meters
(N) Display Units
(O) Sensor Controllers
(P) Switching Mode Power Supplies
(Q) Stepper Motors & Drivers & Controllers
(R) Graphic/ Logic Panels
(S) Field Network Devices
(T) Software

MP5S/Y/W Series

Output Modes [出力モード]

- MP5 Series supports 6 output modes. (There is no output mode in indicator models).
- Requirement for setting comparative value: (B output mode) $LL < L < H < HH$, (F output mode) $L < H$, (other output modes) individual output operation regardless of size or order of set comparative values.

※1: hysteresis

Standard Output Mode [標準出力モード]

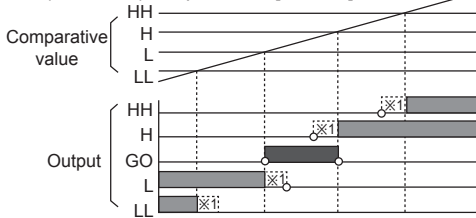

- HH output : Display value \geq Comparative setting value HH
- H output : Display value \geq Comparative setting value H
- L output : Display value \leq Comparative setting value L
- LL output : Display value \leq Comparative setting value LL
- ※GO output ON when there are no HH, H, L, LL outputs

High Output Mode [高出力モード]

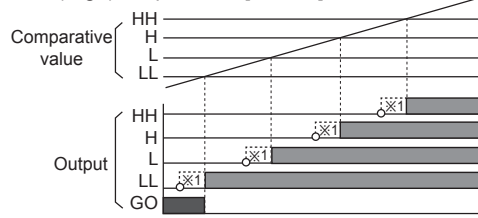

- HH output : Display value \geq Comparative setting value HH
- H output : Display value \geq Comparative setting value H
- L output : Display value \geq Comparative setting value L
- LL output : Display value \geq Comparative setting value LL
- ※GO output ON when there are no HH, H, L, LL outputs

Low Output Mode [低出力モード]

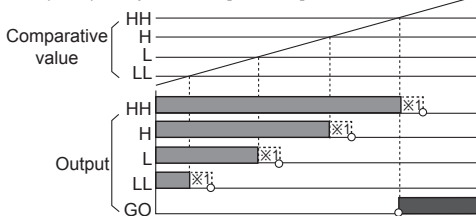

- HH output : Display value \leq Comparative setting value HH
- H output : Display value \leq Comparative setting value H
- L output : Display value \leq Comparative setting value L
- LL output : Display value \leq Comparative setting value LL
- ※GO output ON when there are no HH, H, L, LL outputs

Block Output Mode [ブロック出力モード]

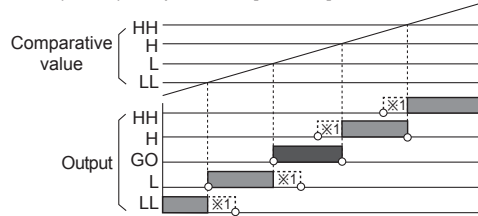

- HH output : Display value \geq Comparative setting value HH
- H output : Comparative setting value HH $>$ Display value \geq Comparative setting value H
- L output : Comparative setting value LL $<$ Display value \leq Comparative setting value L
- LL output : Display value \leq Comparative setting value LL
- ※GO output ON when there are no HH, H, L, LL outputs

One-shot Output Mode [ワンショット出力モード]

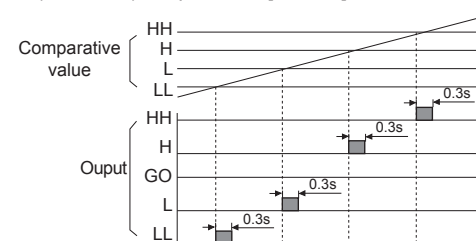

- HH output : Display value \geq Comparative setting value HH
- H output : Comparative setting value HH $>$ Display value \geq Comparative setting value H
- L output : Comparative setting value H $>$ Display value \geq Comparative setting value L
- LL output : Comparative setting value L $>$ Display value \geq Comparative setting value LL
- ※No GO output
- ※One-shot output time is fixed at 0.3 sec.
- ※No hysteresis

Deflection Output Mode [変位出力モード]

Transmits outputs when the saved setting value exceeds H deviation or L deviation.

- Saving setting value: press the **MODE**+**ENTER** keys to save as setting value.
- Checking setting value: press the **ENTER** key to check the setting value.
- Setting deviation: Sets H deviation [P5t. H], and L deviation [P5t. L] of parameter group 0,2 with the setting value as reference. (The set deviation value is saved during Power OFF until it is re-set.)
- Deviation setting range: 0.0001 to 99999 (the setting range varies depending on the decimal point [dpt.] setting.)

E.g.) Decimal point [dpt.]: 0000.0, Setting range: 0.1 to 9999.9

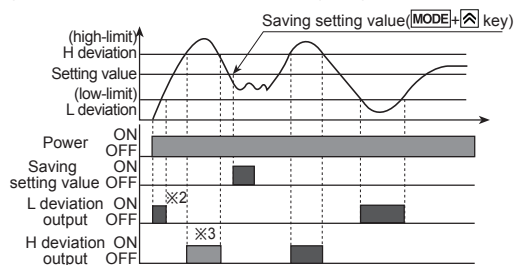

- ※2: When selecting initial comparative output limit function, it does not transmit outputs.
- ※3: The graph is assuming that there is a saved setting value prior to the setting value save point. The actual output position may be different.
- ※There are no HH, GO, LL outputs.
- ※The deviation can be set to "0" but the actual operation will be the same as "1".

Function

Hysteresis [HYS]

The output may turn ON/OFF frequently near the comparative setting value. To prevent this, set the hysteresis value with the comparative setting value as reference.

※A: hysteresis value

※The hysteresis value can be set to "0" but the actual operation value will be at "1".

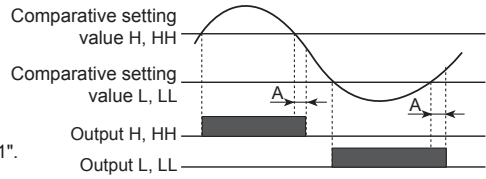

Delay Monitoring [GUARD]

After supplying power, the the starting current of motors and other inputs may experience changes. This function allows stable control by limiting all outputs for a certain period until the target measurement unit stabilizes. It may also control L, LL outputs until a specific output is reached.

Comparative output limit function [DEFY]

- Only for S(Standard), B(Block), F(Deflection) output mode.
- Limits L, LL output before H, HH output.

※Initial L, LL outputs does not operate, so GO output operates.

1) During S(Standard) output mode

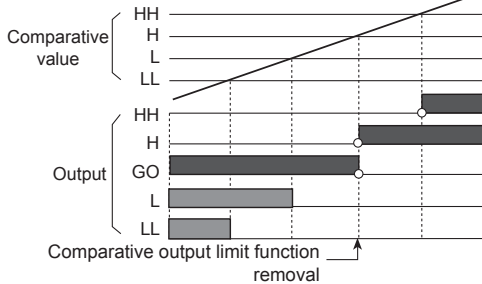

※After supplying power, there is no initial L, LL comparative outputs ().

※Each setting value of HH, H, L, LL is not related to their relative sizes. Hence, HH value may be lower or equal to LL value.

2) During B(Block) output mode

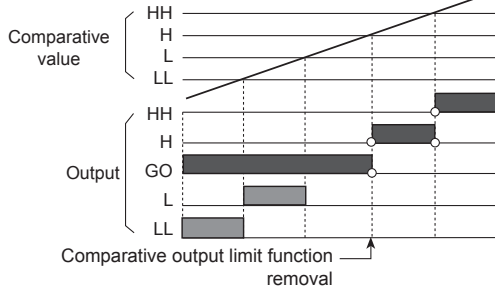

3) During F(Deflection) output mode

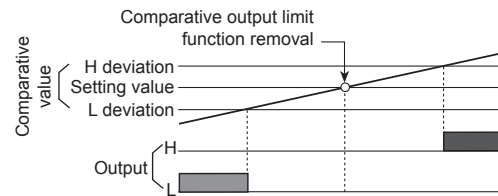

※After supplying power, there is no comparative output () of L deviation.

※In F output mode, the comparative output limiting function is removed at the set value (standard setting)

※H and L deviation are not related to their relative sizes.
(H deviation setting value > L deviation setting value,
H deviation setting value < L deviation setting value)

Start compensation timer function [START]

Set monitoring delay time so that there is no output during the delay time.

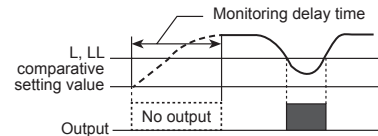

Auto-zero Time Setting [AUTOA, AUTOB]

When there is no input signal during auto-zero set time, the display value is automatically set to 0(zero). Please set the auto-zero set time so that it is longer than the interval of the slowest input signal. If the setting time is too long and there is no input signal, the rate at which the display value falls to 0(zero) decrease, and output response rate may slow down.

Data bank [PBAE](only for MP5W)

Comparative setting value and prescale value are saved as two types(data bank 1, 2) and can be selected for use by opening or shorting of terminals.

- Terminal 3, 5 open: use value of data bank 1
- Terminal 3, 5 short: use value of data bank 2

Prescale [PSCOH, PSCOH]

Displays values in required units or specific multiples by counting the number of input pulses, then multiplying the number of pulses or the length of pulses by variables(X×10y).

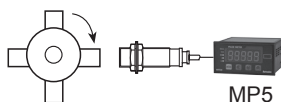

$$\text{Number of revolutions(rpm)} = f \times \alpha$$

$$= f \times 60 \times (1 / N)$$

$$= f \times 60 \times (1 / 4)$$

$$= f \times 60 \times 0.25$$

$$= f \times 15$$

※f: The number of input pulses per second[Hz].

α: Prescale value

N: The number of pulses per revolution

Setting prescale value(α=15)

Set mantissa(X) as 1.5000, and exponent(Y) as 1 for prescale value(α=15).

The same display value can be obtained with α value set as X=0.1500, and Y=2.

(A)	Photoelectric Sensors
(B)	Fiber Optic Sensors
(C)	Door/Area Sensors
(D)	Proximity Sensors
(E)	Pressure Sensors
(F)	Rotary Encoders
(G)	Connectors/ Connector Cables/ Sensor Distribution Boxes/ Sockets
(H)	Temperature Controllers
(I)	SSRs / Power Controllers
(J)	Counters
(K)	Timers
(L)	Panel Meters
(M)	Tacho / Speed / Pulse Meters
(N)	Display Units
(O)	Sensor Controllers
(P)	Switching Mode Power Supplies
(Q)	Stepper Motors & Drivers & Controllers
(R)	Graphic/ Logic Panels
(S)	Field Network Devices
(T)	Software

MP5S/Y/W Series

RS485 Communication Output

- Applicable for models with RS485 communication output through sub output (MP5Y□5, MP5W□8/9). Please refer to 'Ordering information'.

1. Communication Specifications

Comm. protocol	Modbus RTU	Communication Speed	2400, 4800, 9600 (default), 19200, 38400 bps
Connection type	RS485	Communication response time	5 to 99ms (default: 20ms)
Application standard	Compliance with EIA RS485	Start Bit	1-bit fixed
Max. connection	31 units (address: 01 to 99)	Data Bit	8-bit fixed
Synchronous method	Asynchronous	Parity Bit	None (default), Even, Odd
Comm. method	Two-wire half duplex	Stop Bit	1, 2-bit (default)
Comm. distance	Max. 800m		

2. System Configuration

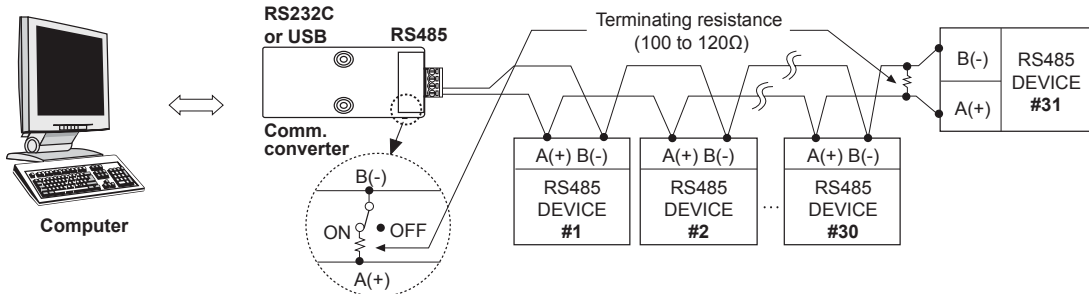

※It is recommended to use Autonics communication converter; SCM-US48I (USB to RS485 converter, sold separately), SCM-38I (RS232C to RS485 converter, sold separately). Please use twisted pair wire for RS485 communication.

3. Communication Control Sequence

- Communication sequence follows Modbus RTU protocol.
- Communication with the host system can be established after 1sec (1,000ms) of supplying power.
- The initial transmission authority is held by the host device (PC). When the host device transmits a request, the MP5W/Y Series sends a response.

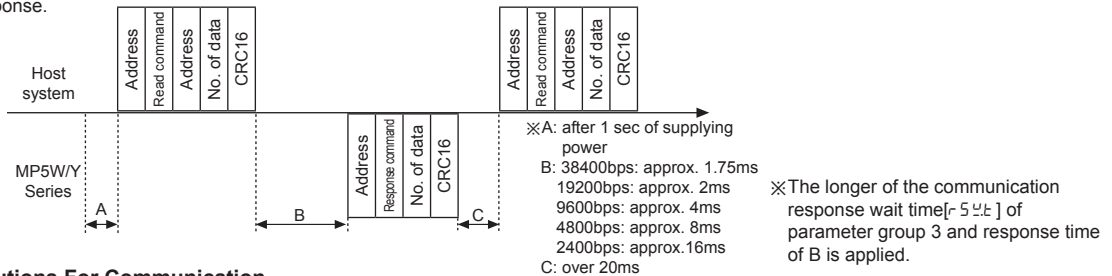

4. Cautions For Communication

- Twisted pair cable (AWG24) is recommended for RS485 communication. When not using twisted pair cables, please make sure that A (+) and B (-) cable lengths are equal.
- After connecting the communication cable, terminating resistors (100 to 120Ω) must be attached at both ends.

5. Communication Command And Block Definition

5-1. Read Coil Status (Func 01 H), Read Input Status (Func 02 H)

1)Query (Master)

Slave Address	Function (command)	Starting Address		No. of Points(no. of data)		Error Check(CRC 16)	
		High	Low	High	Low	Low	High
1Byte	1Byte	1Byte	1Byte	1Byte	1Byte	1Byte	1Byte

CRC16

2)Response(Slave)

Slave Address	Function (command)	Byte Count (no. of data byte)	Data(low)	Data	Data(high)	Error Check(CRC 16)	
						Low	High
1Byte	1Byte	1Byte	1Byte	1Byte	1Byte	1Byte	1Byte

CRC16

5-2. Read Holding Registers(Func 03 H), Read Input Registers(Func 04 H)

1)Query(Master)

Slave Address	Function (command)	Starting Address		No. of Points(no. of data)		Error Check(CRC 16)	
		High	Low	High	Low	Low	High
1Byte	1Byte	1Byte	1Byte	1Byte	1Byte	1Byte	1Byte

CRC16

MP5S/Y/W Series

6. Address Mapping Table

6-1. Read Coil Status(Func 01) / Force Single Coil(Func 05)

No.(Address)	Func	R/W	Parameter		Description	Setting range	Note
000001(0000)	01	R/W	HH	HH comparative output	Comparative output LED	0: OFF / 1:ON	
000002(0001)	01	R/W	H	H comparative output		0: OFF / 1:ON	
000003(0002)	01	R/W	GO	GO comparative output		0: OFF / 1:ON	
000004(0003)	01	R/W	L	L comparative output		0: OFF / 1:ON	
000005(0004)	01	R/W	LL	LL comparative output		0: OFF / 1:ON	
000006(0005)	01	R/W				0: OFF / 1:ON	
000007(0006)	01	R/W				0: OFF / 1:ON	
000008 to 000050	01	R/W				0: OFF / 1:ON	

6-2. Read Input Status(Func 02)

No.(Address)	Func	R/W	Parameter		Description	Setting range	Note
100001(0000)	02	R		RESET(HOLD)	External input	RESET input status	
100002(0001)	02	R		BANK	variables	BANK input status	
100003(0002)	02	R				0: OFF / 1:ON	
100004(0003)	02	R				0: OFF / 1:ON	
100005(0004)	02	R				0: OFF / 1:ON	
100006(0005)	02	R				0: OFF / 1:ON	
100007(0008)	02	R				0: OFF / 1:ON	
100008(0007)	02	R				0: OFF / 1:ON	
100009(0008)	02	R				0: OFF / 1:ON	
100010(0009)	02	R				0: OFF / 1:ON	
100011(000A)	02	R				0: OFF / 1:ON	
100012 to 100050	02	R				0: OFF / 1:ON	

6-3. Read Input Registers(Func 04)

No.(Address)	Func	R/W	Parameter		Description	Factory default	Note
300001 to 300100	04	R			Reserved		
300101(0064)	04	R			Product number H	0	Dedicated model number
300102(0065)	04	R			Product number L	0	
300103(0066)	04	R			Hardware Version	1	
300104(0067)	04	R			Software Version	1	
300105(0068)	04	R			Model 1	"MP"	
300106(0069)	04	R			Model 2	"5□"	
300107(006A)	04	R			Model 3	"□"	
300108(006B)	04	R			Model 4	"□"	
300109(006C)	04	R			Model 5	" "	
300110(006D)	04	R			Model 6	" "	
300111(006E)	04	R			Model 7	" "	
300112(006F)	04	R			Model 8	" "	
300113(0070)	04	R			Model 9	" "	
300114(0071)	04	R			Model 10	" "	
300115(0072)	04	R			Reserved		MP5-□5, MP5W-□8 (※MP5W-□9 displayed as MP5W-□8)
300116(0073)	04	R			Reserved		
300117(0074)	04	R			Reserved		
300118(0075)	04	R			Coil Status Start Address	0000	
300119(0076)	04	R			Coil Status Quantity	0	
300120(0077)	04	R			Input Status Start Address	0000	
300121(0078)	04	R			Input Status Quantity	0	
300122(0079)	04	R			Holding Register Start Address	0000	
300123(007A)	04	R			Holding Register Quantity	0	
300124(007B)	04	R			Input Register Start Address	0000	
300125(007C)	04	R			Input Register Quantity	0	
300126 to 300200	04	R			Reserved		
No.(Address)	Func	R/W	Parameter		Description	Setting range	Note
301001(03E8)	04	R	HH H GO L LL	Front display LED	HH LED Display H LED Display GO LED Display L LED Display LL LED Display	0: OFF 1:ON 0: OFF 1:ON 0: OFF 1:ON 0: OFF 1:ON 0: OFF 1:ON	0 Bit 1 Bit 2 Bit 3 Bit 4 Bit
301002(03E9) 301003(03EA)	04	R	PV		Measurement value	-19999 to 99999	
301004(03EB)	04	R	DOT			0: 00000 1: 00000 2: 00000	
301005(03EC)	04	R	UNIT			0: 999.99s 5: 999.99m 1: 9999.9s 6: 9999.9m 2: 99m59.9s 7: 99h59.9m 3: 9h59m59s 8: 999h59m 4: 99999s 9: 99999m	
301006(03ED)	04	R	MODE		Operation mode	0: F1 to 1: F2 14: F15 2: F3 15: F16	
301007(03EE)	04	R					

6-4. Read Holding Registers(Func 03) / Preset Single Register(Func 06)/ Preset Multiple Registers(Func 16)

6-4-1. Comparative value settings and peak value check group

No.(Address)	Func	R/W	Parameter	Description	Setting range	Factory default
400001(0000)	03/16	R/W	P5t.HH	Preset HH	HH comparative value	0 to 99999
400002(0001)						
400003(0002)	03/16	R/W	P5t.H	Preset H	H comparative value	0 to 99999
400004(0003)						
400005(0004)	03/16	R/W	P5t.L	Preset L	L comparative value	0 to 99999*1
400006(0005)						
400007(0006)	03/16	R/W	P5t.LL	Preset LL	LL comparative value	0 to 99999*1
400008(0007)						
400009(0008)	03/16	R/W	HPEt	High Peak	High peak value of measured value	99999*2
400010(0009)						
400011(000A)	03/16	R/W	LPEt	Low Peak	Low peak value of measured value	-19999*2
400012(000B)						
400013 to 400050	03/06/16	R/W	Reserved			

*1: In operation modes F8, F10, F14, F15, the setting range is -19999 to 99999

*2: Max./Min. measurement value

6-4-2. Parameter 1 group

No.(Address)	Func	R/W	Parameter	Description	Setting range	Factory default
400051(0032)	03/06/16	R/W	n o d E	Mode	Input operation mode	0: F 1 to 15: F 15
400052(0033)	03/06/16	R/W	i n - A	Input A	Sensor type	0: n P n H F 1: n P n L F 2: P n P H F 3: P n P L F
400053(0034)	03/06/16	R/W	i n - B	Input B		
400054(0035)	03/06/16	R/W	o U t - t	Output type	Output mode	0: 5 t A r r d 1: o U t - H 2: o U t - L 3: o U t - b 4: o U t - i 5: o U t - F
400055(0036)	03/06/16	R/W	H Y S	Hysteresis	Hysteresis value	1 to 9999
400056(0037)	03/06/16	R/W	G U A r d	Output limit	Output limit function	0: F d E F Y 1: 5 t A r r t
400057(0038)	03/06/16	R/W	5 t A r r t	Start limit value	Start compensation timer value	0.0 to 99.9
400058(0039)	03/16	R/W	A U t o A	Auto-zero A	Auto-zero time	0.1 to 9999.9
400059(003A)	03/16	R/W				
400060(003B)	03/16	R/W	A U t o B	Auto-zero B		
400061(003C)	03/16	R/W				
400062(003D)	03/06/16	R/W	n E n o	Memory	Memory retention	0: o F F 1: o n
400063 to 400100	03/06/16	R/W	Reserved			

6-4-3. Parameter 2 group

No.(Address)	Func	R/W	Parameter	Description	Setting range	Factory default
400101(0064)	03/06/16	R/W	P b A n t	Data bank	Data bank	0: 1 1: 2
400102(0065)	03/06/16	R/W	d o t	Dot	Decimal point	0: 00000 1: 00000 2: 00000 3: 00000 4: 00000
400103(0066)	03/06/16	R/W	t U n t	Time unit	Time unit	0: t 5 E C 1: t n i n
400104(0067)	03/06/16	R/W	t 5 E C	Time sec	Time range	0: 999.99 999.99s 1: 9999.9 9999.9s 2: 9959.9 99m59.9s 3: 9595.9 9h59m59s 4: 9999.9 99999s 5: 9999.9 999.99m 6: 9999.9 9999.9m 7: 9959.9 99h59.9m 8: 9995.9 999h59m 9: 9999.9 99999m

(A) Photoelectric Sensors

(B) Fiber Optic Sensors

(C) Door/Area Sensors

(D) Proximity Sensors

(E) Pressure Sensors

(F) Rotary Encoders

(G) Connectors/ Connector Cables/ Sensor Distribution Boxes/ Sockets

(H) Temperature Controllers

(I) SSRs / Power Controllers

(J) Counters

(K) Timers

(L) Panel Meters

(M) Tacho / Speed / Pulse Meters

(N) Display Units

(O) Sensor Controllers

(P) Switching Mode Power Supplies

(Q) Stepper Motors & Drivers & Controllers

(R) Graphic/ Logic Panels

(S) Field Network Devices

(T) Software

MP5S/Y/W Series

6-4-3. Parameter 2 group

No.(Address)	Func.	R/W	Parameter	Description	Setting range	Factory default
400105(0068)	03/16	R/W	P5LHH	Preset HH	HH comparative value	0 to 99999
400106(0069)	03/16	R/W				
400107(006A)	03/16	R/W	P5LH	Preset H	H comparative value	0 to 99999
400108(006B)	03/16	R/W				
400109(006C)	03/16	R/W	P5LL	Preset L	L comparative value	0 to 99999 ^{※1}
400110(006D)	03/16	R/W				
400111(006E)	03/16	R/W	P5LLL	Preset LL	LL comparative value	0 to 99999 ^{※1}
400112(006F)	03/16	R/W				
400113(0070)	03/16	R/W	P5LARH	Prescale A Mantissa	Prescale A mantissa	0.0001 to 9.9999
400114(0071)	03/16	R/W				
400115(0072)	03/06/16	R/W	P5LARH	Prescale A Exponent	Prescale A exponent	00 to 09: +(0 to 9) 10 to 19: -(0 to 9)
400116(0073)	03/16	R/W	P5LbH	Prescale B Mantissa	Prescale B mantissa	0.0001 to 9.9999
400117(0074)	03/16	R/W				
400118(0075)	03/06/16	R/W	P5LbH	Prescale B Exponent	Prescale B exponent	00 to 09: +(0 to 9) 10 to 19: -(0 to 9)
400119(0076)	03/06/16	R/W	d! 5P	Display time	Display cycle	0: 0FF 4: 2 1: 005 5: 4 2: 05 6: 8 3: 1
400120(0077)	03/16	R/W	EoUnb	INB Setting value	Operation mode F16 INB	1 to 99999
400121(0078)	03/16	R/W				
400122 to 400150	03/06/16	R/W	Reserved			

※1: In operation modes F8, F10, F14, F15, the setting range is -19999 to 99999

6-4-4. Parameter 3 group

No.(Address)	Func.	R/W	Parameter	Description	Setting range	Factory default
400151(0096)	03/16	R/W	F5-H	Full scale High	High-limit value of PV transmission output	Setting range varies by model and operation mode ^{※1}
400152(0096)						
400153(0096)						
400154(0096)	03/16	R/W	F5-L	Full scale Low	Low-limit value of PV transmission output	0
400155(0096)	03/06/16	R/W	nA	mA	Transmission output spec.	0: 4-20 (mA) 1: 0-20 (mA)
400156(0096)	03/06/16	R/W	Addr	Unit address	Communication address	1 to 99
400157(0096)	03/06/16	R/W	bPS	Bit per Sec	Communication Speed	0: 2400 1: 4800 2: 9600 3: 19200 4: 38400
400158(0096)	03/06/16	R/W	Prty	Parity bit	Communication parity bit	0: none 1: Even 2: odd
400159(0096)	03/06/16	R/W	StP	Stop bit	Communication stop bit	0: 1 1: 2
400160(0096)	03/06/16	R/W	r5wt	Response waiting time	Communication response waiting time	5 to 99(ms)
400161(0096)	03/06/16	R/W	Eonw	Communication write	Communication write enable/disable	0: d! 5R 1: EnR
400162(0096)	03/06/16	R/W	Lc	Lock	Lock	0: 0FF 1: Lc.0 2: Lc.1 3: Lc.2 4: Lc.3
400163 to 400200	03/06/16	R/W	Reserved			

※1: High-limit/low-limit setting value of PV transmission output. (varies by model and operation mode)

Series	Operation mode	Setting range
MP5Y	F1, F2, F7, F9, F11, F12, F13, F16	0 to 99999
	F3, F4, F5, F6	0.01 to set time range
MP5W	F8, F10, F14, F15	-19999 to 99999

■ Comprehensive Device Management Program (DAQMaster)

- DAQMaster is comprehensive device management program for convenient management of parameters and multiple device data monitoring.
- Visit our website (www.autonics.com) to download user manual and comprehensive device management program.

< Computer specification for using software >

Item	Minimum requirements
System	IBM PC compatible computer with Intel Pentium III or above
Operations	Microsoft Windows 98/NT/XP/Vista/7/8/10
Memory	256MB+
Hard disk	1GB+ of available hard disk space
VGA	Resolution: 1024×768 or higher
Others	RS-232 serial port (9-pin), USB port

< DAQMaster screen >



■ Cautions During Use

- Please separate the unit wiring from high voltage lines or power lines to prevent inductive noise.
- Install a power switch or circuit breaker to control the power supply.
- The power switch or circuit breaker should be installed where it is easily accessible by the user.
- Do not use the unit in the following environments.
 - ① Environments with high vibration or shock.
 - ② Environments with exposure to direct sunlight.
 - ③ Near machinery which produce strong magnetic force or electric noise.

Storing the unit
When storing the unit for an extended period, please avoid direct exposure to sunlight. Ambient temperature should be between -20°C to 60°C and ambient humidity should be between 35% to 85%RH. Store in factory packaging for best results.

- Input line
Please use a shield wire in environments where noise may occur or instances where long measurement input lines are required.
- Please maintain distance between the power supply line and measurement input line.
- This product may be used in the following environments
 - ① Indoors
 - ② Max. altitude: 2,000m
 - ③ Pollution degree 2
 - ④ Installation category II

(A) Photoelectric Sensors

(B) Fiber Optic Sensors

(C) Door/Area Sensors

(D) Proximity Sensors

(E) Pressure Sensors

(F) Rotary Encoders

(G) Connectors/ Connector Cables/ Sensor Distribution Boxes/ Sockets

(H) Temperature Controllers

(I) SSRs / Power Controllers

(J) Counters

(K) Timers

(L) Panel Meters

(M) Tacho / Speed / Pulse Meters

(N) Display Units

(O) Sensor Controllers

(P) Switching Mode Power Supplies

(Q) Stepper Motors & Drivers & Controllers

(R) Graphic/ Logic Panels

(S) Field Network Devices

(T) Software