

Autonics

INDUCTIVE PROXIMITY SENSOR (CYLINDRICAL METAL AC CONNECTOR TYPE)

PRCM SERIES

M A N U A L



Thank you very much for selecting Autonics products.
For your safety, please read the following before using.

Caution for your safety

※Please keep "Caution for your safety" to avoid accidents or damages as using it correctly.

※The meaning of 'Warning' and 'Caution' is as follows;

Warning In case a serious injury or dead may be occurred.

Caution In case a little injury or damage of this unit may be occurred.

※The meaning of the mark on the product and manual is as follows;

△ is a caution mark for danger in special condition.

Warning

1. In case of using this unit with machinery(Ex: nuclear power control, medical equipment, ship, vehicle, train, airplane, combustion apparatus, safety device, crime/disaster prevention equipment, etc) which may cause damages to human life or property, it is required to install fail-safe device. It may cause a fire, human injury or damage to property.

2. Do not connect power directly without load.

It may result in damage to inner components or burn them out.

Caution

1. Do not use this unit in place where there is flammable, explosive gas, chemical or strong alkalis, acids. It may cause a fire or explosion.

2. Do not impact on this unit.

It may result in malfunction or damage to the product.

3. Please observe specification rating.

It may result in serious damage to the product.

Ordering information

P R C M L 18-5 A O

Output	O	Normally open
Power supply	C	Normally closed
Sensing distance	Number	Sensing distance(Unit: mm)
Dimension	Number	Diameter of head(Unit: mm)
Body size	No mark	Standard type
Connection	L	Long body
Shape	CM	Connector type
Item	R	Cylindrical type
	C	Inductive proximity sensor

Control output diagram & Load operating

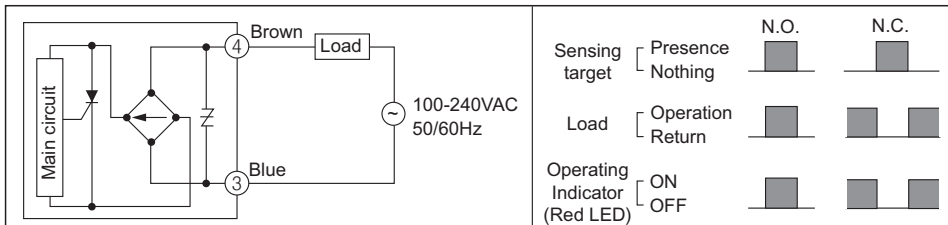

※The above specifications are changeable at anytime without notice.

Specifications

Model	PRCM12-2AO PRCM12-2AC	PRCM12-4AO PRCM12-4AC	PRCM18-5AO PRCM18-5AC PRCML18-5AO PRCML18-5AC	PRCM18-8AO PRCM18-8AC PRCML18-8AO PRCML18-8AC	PRCM30-10AO PRCM30-10AC PRCML30-10AO PRCML30-10AC	PRCM30-15AO PRCM30-15AC PRCML30-15AO PRCML30-15AC
Sensing distance	2mm	4mm	5mm	8mm	10mm	15mm
Hysteresis	Max. 10% of sensing distance					
Standard sensing target	12X12X1mm(Iron)	18X18X1mm(Iron)	25X25X1mm(Iron)	30X30X1mm(Iron)	45X45X1mm(Iron)	45X45X1mm(Iron)
Setting distance	0 to 1.4mm	0 to 2.8mm	0 to 3.5mm	0 to 5.6mm	0 to 7mm	0 to 10.5mm
Power supply (Operating voltage)	100-240VAC 50/60Hz(85-264VAC)					
Leakage current	Max. 2.5mA					
Response frequency*1	20Hz					
Residual voltage	Max. 10V					
Affection by Temp.	When it is 20°C at the rated ambient temperature, it is below 10%					
Control output	5 to 150mA		5 to 200mA			
Insulation resistance	Min. 50MΩ (at 500VDC megger)					
Dielectric strength	2,500VAC 50/60Hz for 1minute					
Vibration	1mm amplitude at frequency of 10 to 55Hz in each of X, Y,Z directions for 2 hours					
Shock	500m/s ² (50G) X, Y, Z directions for 3 times					
Indicator	Operating indicator : Red LED					
Environ-ment	Ambient temperature	-25 to 70°C, Storage: -30 to 80°C				
	Ambient humidity	35 to 95%RH, Storage: -30 to 95%RH				
Protection circuit	Surge protection circuit					
Protection	IP67(IEC standards)					
Insulation type	Double insulation or reinforced insulation (Mark: □, dielectric strength between the measuring input part and the power part: 1kV)					
Material	Case and nut: Nickel-plated brass, Washer: Nickel-plated steel, Sensing part: PBT					
Approval	CE					
Unit weight*2	Approx. 42g(Approx. 30g)	PRCM: Approx. 66g(Approx. 54g)	PRCML: Approx. 78g(Approx. 66g)	PRCM: Approx. 154g(Approx. 142g)	PRCML: Approx. 194g(Approx. 182g)	

*1: The response frequency is the average value. The standard sensing target is used and the width is set as 2 times of the standard sensing target, 1/2 of the sensing distance for the distance.
*2: The weight with packaging and the weight in parentheses is only unit weight. ※Environment resistance is rated at no freezing or condensation.

Dimensions

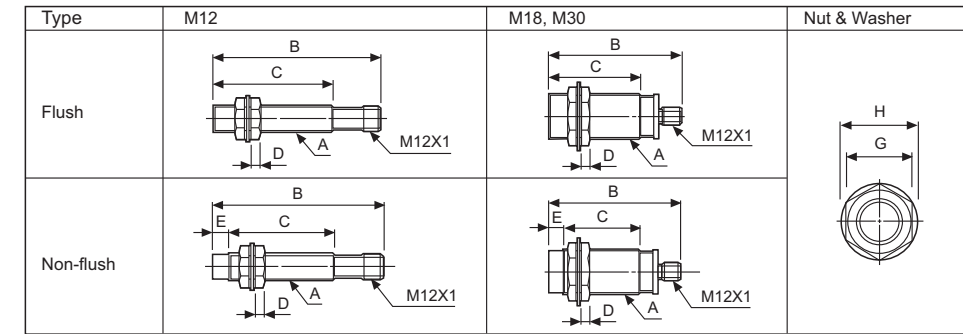

Type		A	B	C	D	E	G	H
Flush	M12	PRCM	M12X1	72.8	48.5	4	-	17
		PRCML	M12X1	60.6	35.3	4	-	24
	M18	PRCM	M18X1	87.3	62	4	-	24
		PRCML	M18X1	63.8	38	5	-	35
	M30	PRCM	M30X1.5	85.8	60	5	-	35
		PRCML	M30X1.5	72.8	41.5	4	7	17
Non-flush	M12	PRCM	M12X1	60.1	25.3	4	10	24
		PRCML	M12X1	86.8	52	4	10	24
	M18	PRCM	M18X1	63.8	28	5	10	35
		PRCML	M18X1	85.8	50	5	10	35
	M30	PRCM	M30X1.5	63.8	28	5	10	35
		PRCML	M30X1.5	85.8	50	5	10	35

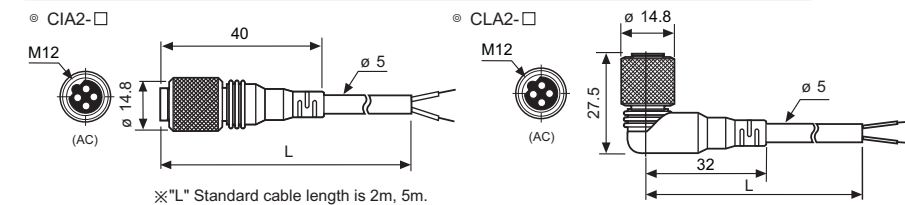

Wiring diagram

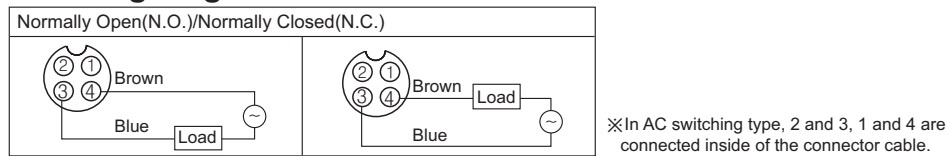

Connection of the power supply

Be sure to connect the power after connecting the load, because direct connection of the proximity sensor may cause damage to the inner elements of this product.

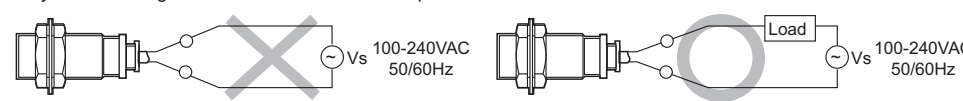

Mutual-interference & Influence by surrounding metals

Mutual-interference

When several proximity sensors are mounted closely, malfunction of sensor may be caused due to mutual interference. Therefore, be sure to provide a minimum distance between the two sensors, as below charts.

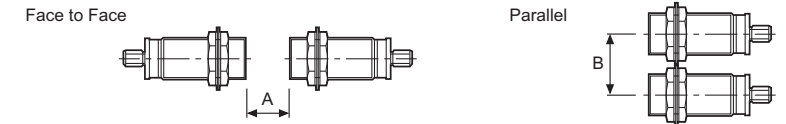

Influence by surrounding metals

When sensors are mounted on metallic panel, it is required to protect the sensors from being affected by any metallic object except target. Therefore, be sure to provide a minimum distance as below chart.

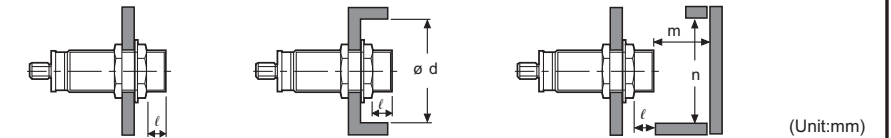

Model Item	PRCM12-2A□	PRCM12-4A□	PRCM(L)18-5A□	PRCM(L)18-8A□	PRCM(L)30-10A□	PRCM(L)30-15A□
A	12	24	30	48	60	90
B	24	36	36	54	60	90
ℓ	0	11	0	14	0	15
∅ d	12	36	18	54	30	90
m	6	12	15	24	30	45
n	18	36	27	54	45	90

Setting distance

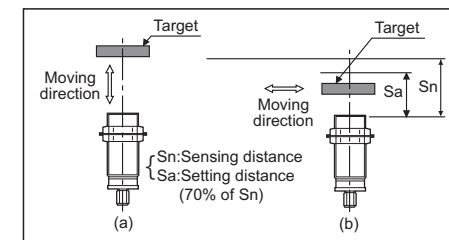

● Sensing distance can be changed by the shape, size or material of the target. Therefore please check the sensing distance like (a), then pass the target within range of setting distance(Sa).

● Setting distance(Sa)
=Sensing distance(Sn)X70%
Ex)PRCM30-10AO
Setting distance(Sa)=10mmX0.7=7mm

Caution for using

- This equipment shall not be used outdoors or beyond specified temperature range.
- Do not apply over tensile strength of cord.
- Do not use the same conduit with cord of this unit and electric power line or power line.
- Do not put overload to tighten nut, please use the supplied washer for tightening.

Model	Strength Series	Front Size	Torque	
			Front	Rear
PRCM12	Flush	13mm	65kgf-cm (6.37N-m)	120kgf-cm (11.76N-m)
	Non-flush	7mm	-	-
PRCM18	Flush	-	-	150kgf-cm(14.7N-m)
	Non-flush	-	-	-
PRCM30	Flush	26mm	500kgf-cm (49N-m)	800kgf-cm (78.4N-m)
	Non-flush	12mm	-	-

Note1) Allowable tightening torque of a nut may be different by the distance from the head. For allowable tightening torque and the range of front and rear parts, refer to [Table 1] and above [Picture 1] respectively. The rear part includes a nut on the head side(see above [Picture 1]). Please apply a tightening torque of the front part when the nut on the front is located in the front part.

Note2) The allowable tightening torque denotes a torque value when using a provided washer as above [Picture 2].

- Please check the voltage changes of power source in order not to exceed rating power input.
- Do not connect capacity load to output part directly.
- Please make wire short as much as possible in order to avoid noise.
- Be sure to cable as indicated specification on this product. If use wrong cable or bended cable, it shall not maintain the water-proof.
- It is possible to extend cable with over 0.3mm² and max. 200m.
- If the target is plated, the operating distance can be changed by the plating material.
- It may result in malfunction by metal particle on product.
- If there are machines(motor, welding etc), which occurs big surge around this unit, please install the Varistor or absorber to source of surge, even though there is built-in surge absorber in this unit.
- If connect the load with big inrush current(DC type bulb) to this unit, the big inrush current will flow due to the initial resistance is low. If the current flows, the resistance of load will be bigger, then it will return to standard current. In this case, proximity sensor might be damaged by inrush current. If you use DC type bulb, please connect extra load or resistance in order to protect proximity sensor from.
- In case of the load current is small : When the load current is under 5mA, make the residual voltage is less than return voltage to connect the bleeder resistor to load in parallel.
※110VAC 50/60Hz:20kΩ, Min. 3W, 220VAC 50/60Hz:39kΩ, Min. 5W
- If make a transceiver close to proximity sensor or wire connection, it may cause malfunction.
- It may cause malfunction if above instructions are not followed.

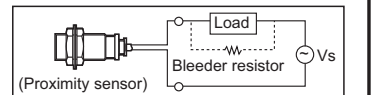

Major products

- Proximity sensors
- Area sensors
- Door/Door side sensors
- Counters
- Rotary encoders
- Power controllers
- Panel meters
- Temperature controllers
- Temperature/Humidity transducers
- Stepping motors/drivers/motion controllers
- Laser marking system(CO₂, Nd:YAG)
- Laser welding/soldering system
- Photoelectric sensors
- Fiber optic sensors
- Pressure sensors
- Timers
- Display units
- Sensor controllers
- Graphic/Logic panels
- Tachometer/Pulse(Rate) meters

Autonics Corporation

http://www.autonics.com

Satisfiable Partner For Factory Automation

HEAD QUARTERS :
41-5, Yongdang-dong, Yongsan-si, Gyeongnam, 626-847, Korea
OVERSEAS SALES :
Bldg. 402 4th Fl., Bucheon Techno Park, 193, Yakdae-dong, Wonn-gu, Bucheon-si, Gyeonggi-do, 420-734, Korea
TEL:82-32-610-2730 / FAX:82-32-329-0728
E-mail : sales@autonics.com

The proposal of a product improvement and development : product@autonics.com

EP-KE-07-0220F