

# Autonics

## INDUCTIVE PROXIMITY SENSOR (CYLINDRICAL DC 3WIRE CONNECTOR)

### PRCM SERIES

#### M A N U A L



Thank you very much for selecting Autonics products.  
For your safety, please read the following before using.

#### Caution for your safety

※Please keep these instructions and review them before using this unit.

※Please observe the cautions that follow;

**Warning** Serious injury may result if instructions are not followed.

**Caution** Product may be damaged, or injury may result if instructions are not followed.

※The following is an explanation of the symbols used in the operation manual.

**Caution:** Injury or danger may occur under special conditions.

#### Warning

- In case of using this unit with machinery(Ex: nuclear power control, medical equipment, ship, vehicle, train, airplane, combustion apparatus, safety device, crime/disaster prevention equipment, etc) which may cause damages to human life or property, it is required to install fail-safe device. It may cause a fire, human injury or damage to property.

#### Caution

- Do not use this unit in place where there are flammable, explosive gas, chemical or strong alkalis, acids. It may cause a fire or explosion.
- Do not impact on this unit. It may result in malfunction or damage to the product.
- Do not apply AC power and observe specification rating. It may result in serious damage to the product.

#### Ordering information

P R CM L 18 - 5 DN

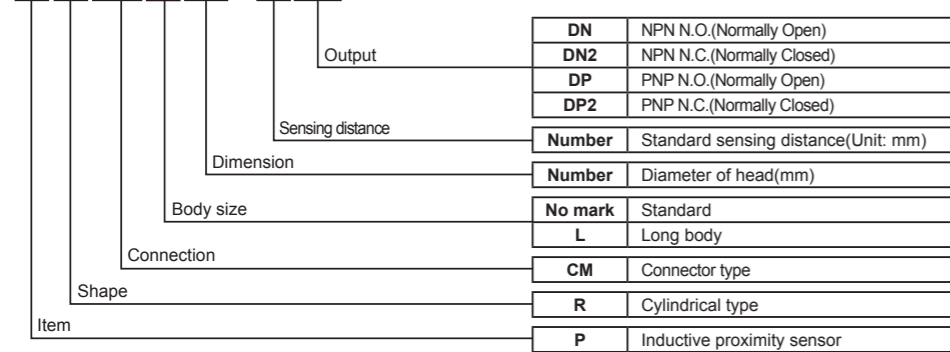

#### Control output diagram & Load operating

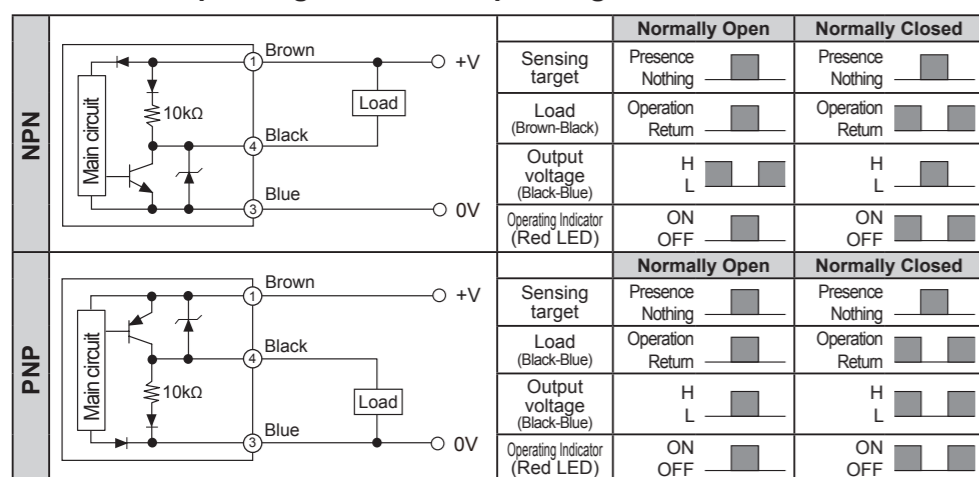

※ The above specifications are subject to change without notice.

#### Specifications

Model	PRCM12-2DN PRCM12-2DP PRCM12-2DN2 PRCM12-2DP2	PRCM12-4DN PRCM12-4DP PRCM12-4DN2 PRCM12-4DP2	PRCM18-5DN PRCM18-5DP PRCM18-5DN2 PRCM18-5DP2	PRCM18-8DN PRCM18-8DP PRCM18-8DN2 PRCM18-8DP2	PRCM30-10DN PRCM30-10DP PRCM30-10DN2 PRCM30-10DP2	PRCM30-15DN PRCM30-15DP PRCM30-15DN2 PRCM30-15DP2
Sensing distance	2mm	4mm	5mm	8mm	10mm	15mm
Hysteresis	Max. 10% of sensing distance					
Standard sensing target	12×12×1mm(Iron)	18×18×1mm(Iron)	25×25×1mm(Iron)	30×30×1mm(Iron)	45×45×1mm(Iron)	
Setting distance	0 to 1.4mm	0 to 2.8mm	0 to 3.5mm	0 to 5.6mm	0 to 7mm	0 to 10.5mm
Power supply (Operating voltage)	12-24VDC (10-30VDC)					
Current consumption	Max. 10mA					
Response frequency <sup>※1</sup>	1.5kHz	500kHz	500kHz	350kHz	400kHz	200kHz
Residual voltage	Max. 1.5V					
Affection by Temp.	Within ±10°C max. of sensing distance at 20°C in temperature range of -25 to 70°C					
Control output	Max. 200mA					
Insulation resistance	Min. 50MΩ(500VDC megger)					
Dielectric strength	1,500VAC 50/60Hz for 1minute					
Vibration	1mm amplitude at frequency of 10 to 55Hz in each of X, Y, Z directions for 2 hours					
Shock	500ms(50G) X, Y, Z directions for 3 times					
Indicator	Operating indicator(RED LED)					
Environment	Ambient temperature -25 to 70°C, Storage: -30 to 80°C					
	Ambient humidity 35 to 95%RH, Storage: 35 to 95%RH					
Protection circuit	surge protection circuit, Reverse polarity protection circuit, Overcurrent protection					
Protection	IP67(IEC Standards)					
Materials	Case/Nut: Nickel plated Brass, Washer: Nickel plated Iron, Sensing surface: PBT					
Approval	CE					
Unit weight <sup>※2</sup>	Approx. 38g(Approx. 26g)	PRCM:Approx. 61g(Approx. 49g) PRCML:Approx. 85g(Approx. 73g)	PRCM:Approx. 146g(Approx. 134g) PRCML:Approx. 181g(Approx. 169g)			

※1: The response frequency is the average value. The standard sensing target is used and the width is set as 2 times of the standard sensing target, 1/2 of the sensing distance for the distance.  
※2: The weight with packaging and the weight in parentheses is only unit weight. ※Environment resistance is rated at no freezing or condensation.

#### Dimensions

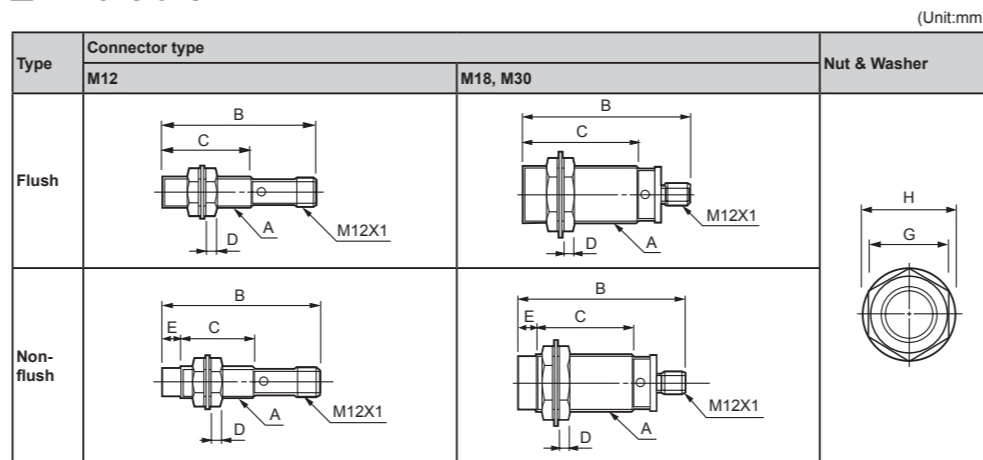

Type		A	B	C	D	E	G	H
Flush	M12	PRCM	M12×1	55.8	31.5	4	-	17
	M18	PRCM	M18×1	54.3	29.5	4	-	24
		PRCML	M18×1	87.3	62.5	4	-	24
	M30	PRCM	M30×1.5	63.8	38	5	-	35
		PRCML	M30×1.5	85.8	60	5	-	35
	Non-flush	M12	PRCM	M12×1	55.8	24.5	4	7
M18		PRCM	M18×1	53.8	19	4	10	24
		PRCML	M18×1	86.8	52	4	10	24
M30		PRCM	M30×1.5	63.8	28	5	10	35
		PRCML	M30×1.5	85.8	50	5	10	35

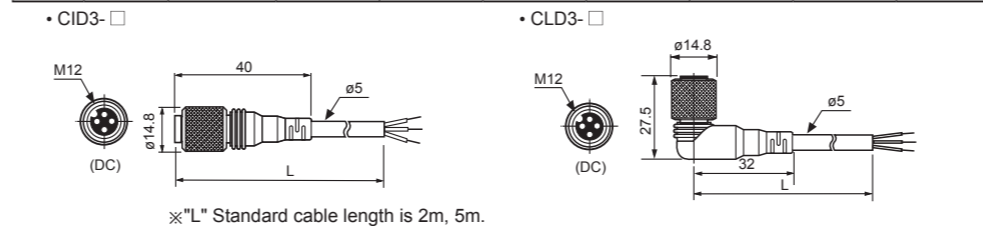

#### Wiring diagram

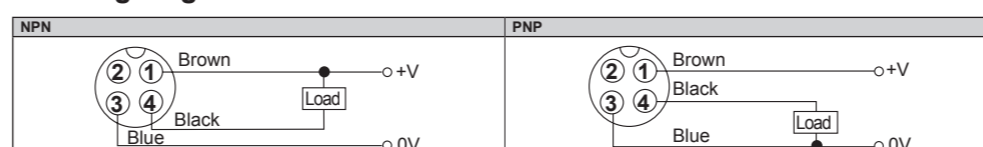

#### Multi-interference & Influence by surrounding metals

##### Mutual-interference

When several proximity sensors are mounted closely, malfunction of sensor may be caused due to mutual interference. Therefore, be sure to provide a minimum distance between the two sensors with referring to the chart below.

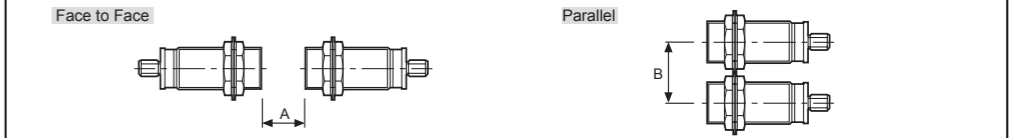

##### Influence by surrounding metals

When sensors are mounted on metallic panel, it is required to protect the sensors from being affected by any metallic object except target. Therefore, be sure to provide a minimum distance as below chart.

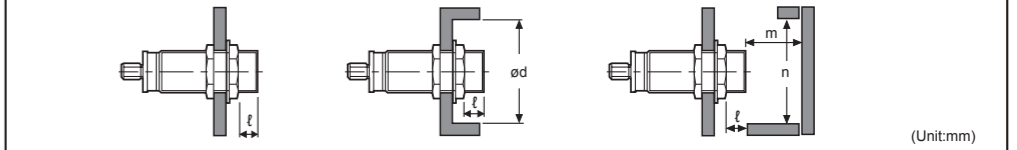

Item	Model	PRCM12-2D□	PRCM12-4D□	PRCM(L)18-5D□	PRCM(L)18-8D□	PRCM(L)30-10D□	PRCM(L)30-15D□
A		12	24	30	48	60	90
B		24	36	36	54	60	90
ℓ		0	11	0	14	0	15
ød		12	36	18	54	30	90
m		6	12	15	24	30	45
n		18	36	27	54	45	90

#### Setting distance

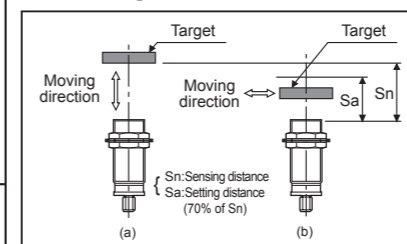

• Sensing distance can be changed by the shape, size or material of the target. Therefore please check the sensing distance like (a), then pass the target within range of setting distance(Sa).

• Setting distance(Sa)  
= Sensing distance(Sn) × 70%  
Ex)PRCM30-10DN  
Setting distance(Sa) = 10mm × 0.7 = 7mm

#### Caution for using

- This equipment shall not be used outdoors or beyond specified temperature range.
- Do not apply over tensile strength of cord. (ø4: 30N max., ø5: 50N max.)
- Do not use the same conduit with cord of this unit and electric power line or power line.
- Do not put overload to tighten nut, please use the supplied washer for tightening.

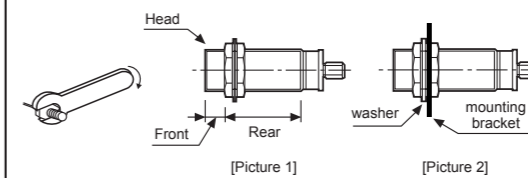

Model	Strength	Front		Rear	
		Size	Torque	Size	Torque
PRCM12 Series	Flush	13mm	65kgf·cm (6.37N·m)	120kgf·cm (11.78N·m)	
	Non-flush	7mm	-	-	-
PRCM18 Series	Flush	-	150kgf·cm (14.7N·m)	-	-
	Non-flush	-	-	-	-
PRCM30 Series	Flush	26mm	500kgf·cm (49N·m)	800kgf·cm (78.4N·m)	
	Non-flush	12mm	-	-	-

Note1) Allowable tightening torque of a nut may be different by the distance from the head. For allowable tightening torque and the range of front and rear parts, refer to [Table 1] and above [Picture 1] respectively. The rear part includes a nut on the head side(see above [Picture 1]). Please apply a tightening torque of the front part when the nut on the front is located in the front part.

Note2) The allowable tightening torque denotes a torque value when using a provided washer as above [Picture 2].

- Please check the voltage changes of power source in order not to exceed rating power input.
- Do not use this unit during transient time(80ms) after apply power.
- It might result in damage to this product, if use automatic transformer. So please use insulated transformer.
- Please make wire as short as possible in order to avoid noise.
- Be sure to use cable as indicated specification on this product. If wrong cable or bended cable is used, it shall not maintain the waterproof.
- It is possible to extend cable with over 0.3mm<sup>2</sup> and max. 200m.
- If the target is plated, the operating distance can be changed by the plating material.
- It may result in malfunction by metal particle on product.
- If there are machines(motor, welding etc), which occurs big surge around this unit, please install the varistor or absorber to source of surge, even though there is built-in surge absorber in this unit.
- If connecting the load with big inrush current(DC type bulb) to this unit, the big inrush current will flow since the initial resistance is low. If the current flows, the resistance of load will be bigger, then it will return to standard current. In this case, proximity sensor might be damaged by inrush current. If you use DC type bulb, please connect extra relay or resistance in order to protect proximity sensor from.
- If making a transceiver close to proximity sensor or wire connection, it may cause malfunction.

※ It may cause malfunction if above instructions are not followed.

#### Major products

- Proximity sensors
- Area sensors
- Photoelectric sensors
- Fiber optic sensors
- Door/Door side sensors
- Sensor controllers
- Graphic/Logic panels
- Temperature controllers
- Tachometer/Pulse(Rate) meters
- Temperature/Humidity transducers
- Switching power supplies
- Stepping motors/drivers/motion controllers
- Field network devices
- Laser marking system(CO<sub>2</sub>, Nd:YAG)
- Laser welding/soldering system
- Counters
- Timers
- Display units
- Panel meters
- Pressure sensors
- Rotary encoders
- Power controllers

**Autonics Corporation**  
http://www.autonics.com

**Satisfiable Partner For Factory Automation**

■HEAD QUARTERS:  
41-5, Yongdang-dong, Yangsan-si, Gyeongnam, 626-847, Korea

■OVERSEAS SALES:  
Bldg. 402 4th FL., Bucheon Techno Park, 193, Yakdae-dong, Wonmi-gu, Bucheon-si, Gyeonggi-do, 420-734, Korea  
TEL: 82-32-610-2730 / FAX: 82-32-329-0728  
E-mail: sales@autonics.com

**The proposal of a product improvement and development :product@autonics.com**