

Autonics

INDUCTIVE PROXIMITY SENSOR CYLINDRICAL TYPE AC 2WIRE

M A N U A L



Thank you very much for selecting Autonics products.
For your safety, please read the following before using.

Caution for your safety

- ⊗ Please keep "Caution for your safety" to avoid accidents or damages as using it correctly.
- ⊗ The meaning of 'Warning' and 'Caution' is as follows:
- Warning** In case a serious injury or dead may be occurred.
- Caution** In case a little injury or damage of this unit may be occurred.
- ⊗ The meaning of the mark on the product and manual is as follows: ⊗ is a caution mark for danger in special condition.

Warning

- In case of using this unit with machinery(Ex: nuclear power control, medical equipm, ship, vehicle, train, airplane, combustion apparatus, safety device, crime/disaster prevention equipment, etc) which may cause damages to human life or property, it is required to install fail-safe device.
It may cause a fire, human injury or damage to property.
- Do not connect power directly without load.
It may cause damage to inner components or burn them out.

Caution

- Do not use this unit in place where there is flammable, explosive gas, chemical or strong alkalis, acids.
It may cause a fire or explosion.
- Do not impact on this unit.
It may cause malfunction or damage to the product.
- Please observe the rated specifications.
It may cause serious damage to the product.

Ordering information

P	Output	O	Normally open
R	Output	C	Normally closed
W	Power supply	A	100-240VAC
L	Sensing distance	Number	Standard sensing distance(Unit: mm)
18	Dimension	Number	Diameter of head(Unit: mm)
5	Body size	No mark	Standard type
A	Connection	L	Long body
O	Shape	No mark	Cable type
	Item	W	Cable connector type
		R	Cylindrical type
		P	Inductive proximity sensor

Control output diagram & Load operation

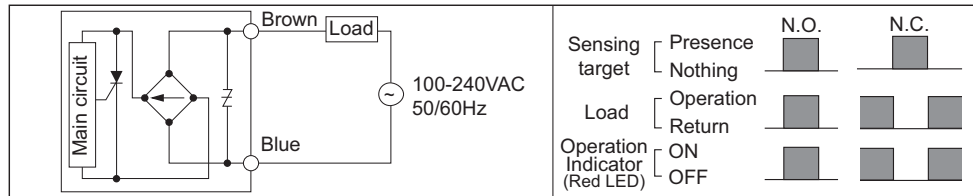

Connections

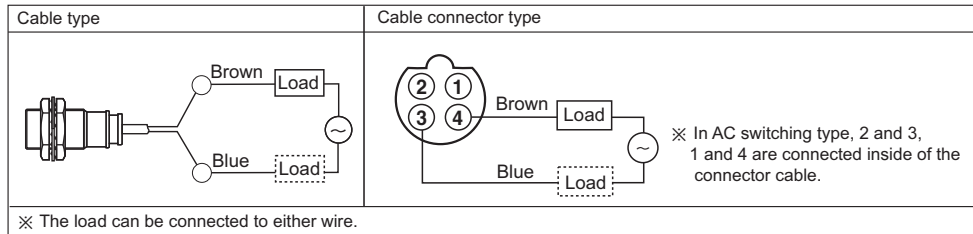

⊗ The load can be connected to either wire.
⊗ The above specification are subject to change without notice.

Specifications

Model	PR12-2AO PR12-2AC PRW12-2AO PRW12-2AC	PR12-4AO PR12-4AC PRW12-4AO PRW12-4AC	PR18-5AO PR18-5AC PRL18-5AO PRW18-5AO PRWL18-5AO PRWL18-5AC	PR18-8AO PR18-8AC PRL18-8AO PRW18-8AO PRWL18-8AO PRWL18-8AC	PR30-10AO PR30-10AC PRL30-10AO PRW30-10AO PRWL30-10AO PRWL30-10AC	PR30-15AO PR30-15AC PRL30-15AO PRW30-15AO PRWL30-15AO PRWL30-15AC
Sensing distance	2mm	4mm	5mm	8mm	10mm	15mm
Hysteresis	Max. 10% of sensing distance					
Standard sensing target	12X2X1mm(iron)		18X18X1mm(iron)	25X25X1mm(iron)	30X30X1mm(iron)	45X45X1mm(iron)
Setting distance	0 to 1.4mm	0 to 2.8mm	0 to 3.5mm	0 to 5.6mm	0 to 7mm	0 to 10.5mm
Power supply (Operating voltage)	100-240VAC (85-264VAC)					
Leakage current	Max. 2.5mA					
Response frequency*1	20Hz					
Residual voltage	Max. 10V					
Affection by Temp.	Max. ± 10% of sensing distance at +20°C within temperature range of -25 to +70°C					
Control output	5 to 150mA			5 to 200mA		
Insulation resistance	Min. 50MΩ (at 500VDC megger)					
Dielectric strength	2,500VAC 50/60Hz for 1minute					
Vibration	1mm amplitude at frequency of 10 to 55Hz in each of X, Y, Z directions for 2 hours					
Shock	500m/s ² (50G) X, Y, Z directions for 3 times					
Indicator	Operation indicator:Red LED					
Environ-ment	Ambient temperature	-25 to 70°C, Storage: -30 to 80°C				
	Ambient humidity	35 to 95%RH, Storage: 35 to 95%RH				
Protection circuit	Surge protection circuit					
Protection	IP67(IEC standard)					
Cable	ø 4, 2-wire, 2m		ø 5, 2-wire, 2m		(AWG22, Core diameter: 0.08mm, Number of cores: 60, Insulator diameter: ø 1.25mm)	
Insulation type	Double insulation or reinforced insulation (Mark: □, dielectric strength between the measuring input part and the power part: 1kV)					
Material	Case and nut: Nickel-plated brass, Washer: Nickel-plated steel, Sensing part: PBT, General cable(Black): Polyvinyl chloride (PVC)					
Approval	CE					
Unit weight*2	PR: Approx. 84g(Approx. 72g) PRW: Approx. 54g(Approx. 42g)		PR: Approx. 130g(Approx. 118g) PRL: Approx. 142g(Approx. 130g) PRW: Approx. 78g(Approx. 66g) PRWL: Approx. 90g(Approx. 78g)		PR: Approx. 207g(Approx. 170g) PRL: Approx. 245g(Approx. 208g) PRW: Approx. 134g(Approx. 122g) PRWL: Approx. 195g(Approx. 158g)	

*1: The response frequency is the average value. The standard sensing target is used and the width is set as 2 times of the standard sensing target, 1/2 of the sensing distance for the distance.
*2: The weight with packaging and the weight in parentheses is only unit weight. ⊗ Environment resistance is rated at no freezing or condensation.

Dimensions

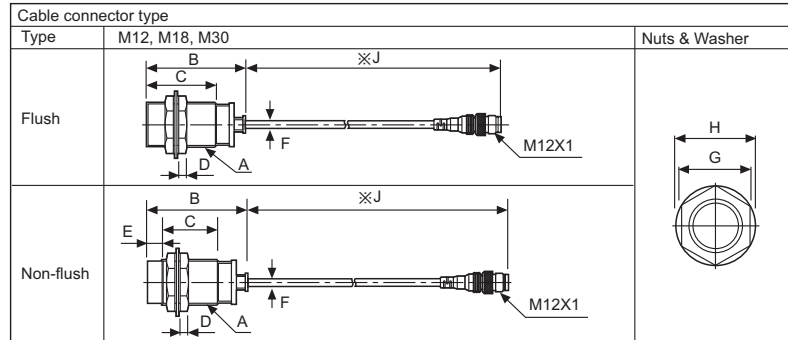
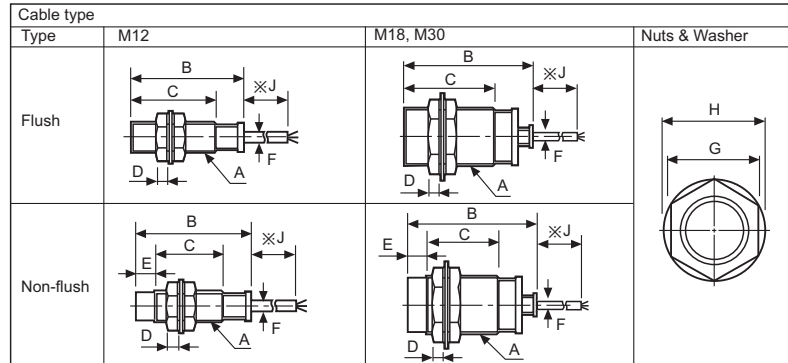

Item		A	B	C	D	E	F	G	H	J	
Flush	M12	PR	M12X1	63	48.5	4	-	4	17	21	2,000
		PRW	M12X1	63	48.5	4	-	4	17	21	300
	M18	PR	M18X1	53.8	35.8	4	-	5	24	29	2,000
		PRW	M18X1	53.8	35.8	4	-	5	24	29	300
	M30	PR	M30X1.5	58	38	5	-	5	35	42	2,000
		PRW	M30X1.5	58	38	5	-	5	35	42	300
Non-flush	M12	PR	M12X1	63	41.5	4	7	4	17	21	2,000
		PRW	M12X1	63	41.5	4	7	4	17	21	300
	M18	PR	M18X1	53.3	25.3	4	10	5	24	29	2,000
		PRW	M18X1	53.3	25.3	4	10	5	24	29	300
	M30	PR	M30X1.5	58	28	5	10	5	35	42	2,000
		PRW	M30X1.5	58	28	5	10	5	35	42	300

(Unit:mm)

Connection of the power supply

Be sure to connect the power after connecting the load, because direct connection of the proximity sensor may cause damage to the inner circuit of this product.



Mutual-interference & Influence by surrounding metals

• **Mutual-interference**
When several proximity sensors are mounted closely, malfunction of sensor may be caused due to mutual interference. Therefore, be sure to keep a minimum distance between the two sensors, as below charts.

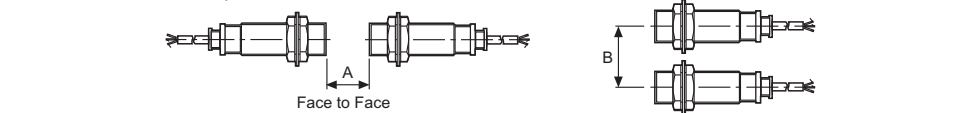

• **Influence by surrounding metals**
When sensors are mounted on metallic panel, it is required to protect the sensors from malfunction by any metallic object. Therefore, be sure to keep a minimum distance as below chart.

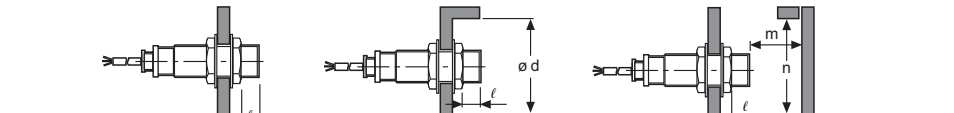

Model Item	PR□12-2AO PRW□12-2AO	PR□12-4AO PRW□12-4AO	PR□18-5AO PRW□18-5AO	PR□18-8AO PRW□18-8AO	PR□30-10AO PRW□30-10AO	PR□30-15AO PRW□30-15AO
A	12	24	30	48	60	90
B	24	36	36	54	60	90
ℓ	0	11	0	14	0	15
ø d	12	36	18	54	30	90
m	6	12	15	24	30	45
n	18	36	27	54	45	90

Setting distance

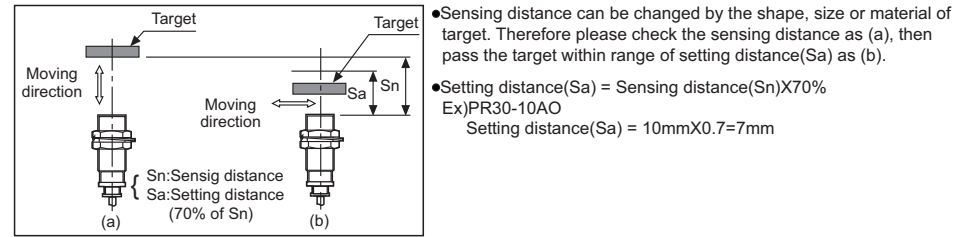

Caution for using

- This equipment shall not be used outdoors or beyond specified temperature range.
 - Do not apply over tensile strength of cord. (ø 4 : max. 30N, ø 5 : max. 50N)
 - Do not use the same conduit with cord of this unit and electric power line or power line.
 - Do not put overload to tighten nut, please use the supplied washer for tightening.
- | | | | |
|-------------|------------------------------|------------------------|-------------------------|
| | Strength | Front | Rear |
| Model | Size | Torque | Torque |
| PR12 Series | Flush 13mm
Non-Flush 7mm | 65kgf·cm
(6.37N·m) | 120kgf·cm
(11.76N·m) |
| PR18 Series | Flush -
Non-Flush - | 150kgf·cm
(14.7N·m) | - |
| PR30 Series | Flush 26mm
Non-Flush 12mm | 500kgf·cm
(49N·m) | 800kgf·cm
(78.4N·m) |
- Note1) Allowable tightening torque of a nut may be different by the distance from the head. For allowable tightening torque and the range of front and rear parts, refer to [Table 1] and above [Figure 1] respectively. The front part range is from head to the size of [Table 1] and the rear part includes a nut (see above [Figure 1]).
Note2) The allowable tightening torque denotes a torque value when using a provided washer as above [Figure 2].
- Please check the voltage changes of power source in order not to exceed the rated power input.
 - Do not connect capacity load to output part directly.
 - Please make wire short as much as possible in order to avoid noise.
 - Be sure to use cable as indicated specification on this product. If using wrong cable or bended cable, it shall not have waterproof properties.
 - It is possible to extend cable with over 0.3mm² and max. 200m.
 - If the target is plated, the operating distance can be changed by the plating material.
 - It may result in malfunction by metal particle on product.
 - If there are machines(motor, welding etc), which occur big surge around this unit, please install the Varistor or absorber to source of surge, even though there is built-in surge absorber in this unit.
 - If connecting the load with big inrush current(DC type bulb) to this unit, the big inrush current will flow because the initial resistance is low. If the current flows, the resistance of load will be bigger, then it will return to standard current. In this case, proximity sensor might be damaged by inrush current. If you use DC type bulb, please connect extra relay or current limit resistor in order to protect proximity sensor.
 - In case of the load current is low : When the load current is under 5mA, make the residual voltage is less than return voltage by connecting the bleeder resistor and load in parallel to flow 5mA to proximity sensor.
⊗ 110VAC 50/60Hz : 20kΩ, Min. 3W, 220VAC 50/60Hz : 39kΩ, Min. 5W
 - If making a transceiver close to proximity sensor or wire connection, it may cause malfunction.

⊗ It may cause malfunction if above instructions are not followed.

Major products

- Proximity sensors
- Area sensors
- Door/Door side sensors
- Counters
- Rotary encoders
- Power controllers
- Panel meters
- Temperature controllers
- Temperature/Humidity transducers
- Stepping motors/drivers/motion controllers
- Laser marking system(CO₂, Nd:YAG)
- Laser welding/soldering system
- Photoelectric sensors
- Fiber optic sensors
- Pressure sensors
- Timers
- Display units
- Sensor controllers
- Graphic/Logic panels
- Tachometer/Pulse(Rate) meters

Autonics Corporation
http://www.autonics.com

Satisfiable Partner For Factory Automation

HEAD QUARTERS :
41-5, Yongjil-dong, Yongsan-si, Gyeongnam, 626-847, Korea

OVERSEAS SALES :
Bldg. 402 4th Fl., Bucheon Techno Park, 193, Yaldae-dong, Wonmi-gu, Bucheon-si, Gyeonggi-do, 430-734, Korea
TEL: 82-32-610-2730 / FAX: 82-32-329-0728
E-mail : sales@autonics.com

The proposal of a product improvement and development : product@autonics.com

EP-KE-07-0210F