

Multi-CH Modular Type Temperature Controller

TM Series

USER MANUAL



TM Series

Thank you very much for selecting Autonics products.

For your safety, please read the following before using.

Preface

Thank you for purchasing an Autonics product.





Please familiarize yourself with the information contained in the Safety Precautions section before using this product.

This user manual contains information about the product and its proper use, and should be kept in a place where it will be easy to access.

User Manual Guide

- Please familiarize yourself with the information in this manual before using the product.
- This manual provides detailed information on the product's features. It does not offer any guarantee concerning matters beyond the scope of this manual.
- This manual may not be edited or reproduced in either part or whole without permission.
- A user manual is not provided as part of the product package.
Visit our web site (www.autonics.com) to download a copy.
- The manual's content may vary depending on changes to the product's software and other unforeseen developments within Autonics, and is subject to change without prior notice.
Upgrade notice is provided through out homepage.
- We contrived to describe this manual more easily and correctly. However, if there are any corrections or questions, please notify us these on our homepage.

User Manual Symbols

Symbol	Description
 Note	Supplementary information for a particular feature.
 Warning	Failure to follow instructions can result in serious injury or death.
 Caution	Failure to follow instructions can lead to a minor injury or product damage.
 Ex.	An example of the concerned feature's use.
※1	Annotation mark.

Safety Precautions

- Following these safety precautions will ensure the safe and proper use of the product and help prevent accidents, as well as minimizing possible hazards.
- Safety precautions are categorized as Warnings and Cautions, as defined below:

 Warning	Warning	Failure to follow the instructions may lead to a serious injury or accident.
--	----------------	--

 Caution	Caution	Failure to follow the instructions may lead to a minor injury or accident.
--	----------------	--

Warning

- Fail-safe device must be installed when using the unit with machinery that may cause serious injury or substantial economic loss. (e.g. nuclear power control, medical equipment, ships, vehicles, railways, aircraft, combustion apparatus, safety equipment, crime/disaster prevention devices, etc.)
Failure to follow this instruction may result in personal injury, fire, or economic loss.
- The unit must be installed on a device panel before use.
Failure to follow this instruction may result in electric shock.
- Do not connect, repair, or inspect the unit while connected to a power source.
Failure to follow this instruction may result in electric shock.
- Check the terminal numbers before connecting the power source.
Failure to follow this instruction may result in fire.
- Do not disassemble or modify the unit. Please contact us if necessary.
Failure to follow this instruction may result in electric shock or fire.

Caution

- Do not use the unit outdoors.
Failure to follow this instruction may result in shortening the life cycle of the unit, or electric shock.
- When connecting the power input and relay output cables, use AWG20 (0.05mm²) cables and make sure to tighten the terminal screw bolt above 0.74N·m to 0.90N·m.
Failure to follow this instruction may result in fire due to contact failure.
- Use the unit within the rated specifications.
Failure to follow this instruction may result in shortening the life cycle of the unit, or fire.
- Do not use loads beyond the rated switching capacity of the relay contact.
Failure to follow this instruction may result in insulation failure, contact melt, contact failure, relay broken, or fire.
- Do not use water or oil-based detergent when cleaning the unit. Use dry cloth to clean the unit.
Failure to follow this instruction may result in electric shock or fire.
- Do not use the unit where flammable or explosive gas, humidity, direct sunlight, radiant heat, vibration, or impact may be present.
Failure to follow this instruction may result in fire or explosion.

- Keep dust and wire residue from flowing into the unit.
Failure to follow this instruction may result in fire or product damage.
- Check the polarity of the measurement input contact before wiring the temperature sensor.
Failure to follow this instruction may result in fire or explosion.
- For installing the unit with reinforced insulation, use the power supply unit which basic level is ensured.

Caution During Use

These handling precautions address issues that can potentially cause the product to malfunction.

(1) Power and Usage Environment

- Must use DC power.
- After connecting input sensors and supplying the power, use the controller 20 minutes later.
- Install a power switch or circuit breaker to control the power supply.
- The power switch or circuit breaker should be installed where it is easily accessible by the user.
- Install the unit at well ventilation place. If not, take the ventilation countermeasures.
- This unit may be used in the following environments.
 - It shall be used indoor.
 - Altitude up to 2,000m
 - Pollution degree 2
 - Installation category II

(2) Sensor Input

- If measurement accuracy is low, check the Input Bias parameter setting.
- When line extension between thermocouple and temperature controller is required, use the specified compensation line. If using the general line, temperature difference at the joint part between thermocouple and extension lines.
- When using RTD temperature sensor, must wire it as 3-wire type. If cable is extended, use 3 wires which are same thickness as the line. It might cause the deviation of temperature when line resistance is different.
- Before changing the input sensor, turn OFF the power. Connect the input sensor and re-supply the power, change parameter settings via communication.
- If power line and input signal line are close each other, install line filter for noise protection at power line and use shielded input signal line.

(3) Noise Effect

- Please separate the unit wiring from high voltage lines or power lines to prevent inductive noise.
- Keep away from the high frequency instruments (High frequency welding machine & sewing machine, large capacity SCR controller) or the devices (radio, television, wireless machines) which causes high frequency interference.

(4) Communication

- Use twisted pair wire for RS485 communication. Connect ferrite bead at each end of line to reduce the effect of external noise.
- Do not overlapping communication line and AC power line.
- If changing the communication address by setting switch, use the flat head driver which is 2mm size or plastic driver. If not, it may cause product damage.

- Use separated power source for the communication converter (SCM-US, SCM-38I, SCM-US48I, sold separately).
- ※ The above specifications are subject to change and some models may be discontinued without notice.

Table of Contents

Preface	3
User Manual Guide.....	4
User Manual Symbols	5
Safety Precautions	6
Caution During Use	8
Table of Contents.....	10
1 Product Introduction.....	14
1.1 Features	14
1.2 Components and accessories.....	15
1.3 Models	19
1.3.1 Model list and descriptions	20
1.4 Parts and features	21
1.4.1 Front parts	21
1.4.2 Other parts.....	23
2 Specifications	24
3 Dimensions	26
3.1 Installation	26
3.1.1 Connector connection	26
3.1.2 Module connection	27
3.1.3 Mounting with bolts.....	28
3.1.4 Mounting on DIN rail.....	28
4 Connections and Insulation Block Diagram	30
4.1 TM2 Series	30
4.2 TM4 Series	31
4.3 Wiring precautions.....	32
4.3.1 Sensor connection.....	32
4.3.2 Power supply connection	33
4.3.3 Communication line wiring	33
4.3.4 Module connection	34
5 Preparation and Startup.....	36
5.1 General process	36
5.2 Setup values when power ON.....	36
5.3 Temperature control examples	37
5.3.1 Single module.....	37
5.3.2 Multiple modules	39
6 Parameter Settings and Functions	40
6.1 Input.....	40
6.1.1 Input type and temperature range	40
6.1.2 Input type.....	41

6.1.3	Input temperature sensor unit	41
6.1.4	Input correction.....	42
6.1.5	Input digital filter	42
6.1.6	SV high/low-limit value	43
6.2	Control output.....	44
6.2.1	Control output operation mode.....	44
6.2.2	Deadband/Overlap band	46
6.2.3	MV high/low-limit value	50
6.2.4	Ramp function	51
6.2.5	Auto/Manual control	53
6.2.6	Manual control baseline MV.....	53
6.2.7	Manual control initial MV	54
6.2.8	Control output.....	54
6.3	Temperature control	55
6.3.1	Temperature control method	55
6.3.2	ON/OFF control.....	55
6.3.3	PID control.....	56
6.3.4	Auto-tuning	59
6.4	Alarm output	61
6.4.1	Alarm output target channel	61
6.4.2	Alarm output operating mode.....	62
6.4.3	Alarm output option	63
6.4.4	Alarm SV	64
6.4.5	Alarm output hysteresis.....	65
6.4.6	Alarm output method.....	65
6.4.7	Alarm output delay	66
6.4.8	Loop break alarm(LBA).....	67
6.4.9	Sensor break alarm.....	70
6.4.10	Heater disconnection alarm	70
6.4.11	Alarm output OFF.....	72
6.4.12	Alarm output examples	73
6.5	Communications.....	76
6.5.1	Communication address	76
6.5.2	Communications speed settings	77
6.5.3	Communications parity bit.....	77
6.5.4	Communication stop bit.....	78
6.5.5	Response wait time.....	78
6.5.6	Enable/Disable communications writing	78
6.5.7	USB-to-Serial connection.....	79
6.6	Monitoring function	80
6.6.1	Control output MV monitoring	80
6.6.2	Heating MV monitoring.....	80
6.6.3	Cooling MV monitoring	80
6.6.4	Heater current monitoring	80
6.7	Run/Stop function.....	81
6.7.1	Control output for STOP.....	81
6.7.2	Alarm output for STOP	81
6.8	Multi SV	82

6.8.1	Number of multi SVs	82
6.8.2	Multi SV No. settings	82
6.8.3	SV for Multi SVs	82
6.9	Digital input.....	83
6.9.1	Digital input terminal settings	83
6.9.2	Digital input terminal target channel	83
6.10	Error.....	84
6.10.1	Sensor error, MV setting.....	84
6.11	Parameter initialization	85
7	Simple Error Diagnosis.....	86
7.1	Error display	86
7.2	Troubleshootings	86
8	DAQMaster.....	88
8.1	Overview.....	88
8.2	Features	89

1 Product Introduction

1.1 Features

TM Series module type temperature controller realizes high-speed controlling with superior sampling cycle (TM4 – 100 ms, TM2 – 50 ms). Side connector connection makes less wiring work and close mounting possible for up to 31 units without additional power and communication wires for expansion modules. PC parameter setting and monitoring is possible via RS485 communication or dedicated USB cable. In addition, more reliable temperature controlling can be realized via various convenient functions.

- Multi channels (4-CH/2-CH) simultaneous controlling possible
 - Each channel insulated – Dielectric strength 1,000VAC
 - No communication and power supply for expansion modules required using module connectors : Up to 31 module (124 channels/62 channels) expansion possible
 - High-speed sampling cycle (100ms/50ms)
 - Heating/Cooling simultaneous controlling
 - Heater burn-out detection via a current transformer (CT).
 - PC parameter setting via PC (USB cable and RS485 communication)
 - : Supports comprehensive device management program (DAQMaster)
 - ※ Communication converter, sold separately: SCM-US (USB to Serial converter),
SCM-38I (RS232C to RS485 converter), SCM-US48I (USB to RS485 converter)
 - : Enables to set parameters via SCM-US which does not required supplying power and wiring
- Easy maintenance via connector type connection
: Sensor input connector, control output connector, power/communication connector
- Multi-input/multi-range
 - Heater disconnection alarm (CT function)
 - ※ CT, sold separately: CSTC-E80LN, CSTC-E200LN

1.2 Components and accessories

(1) Components

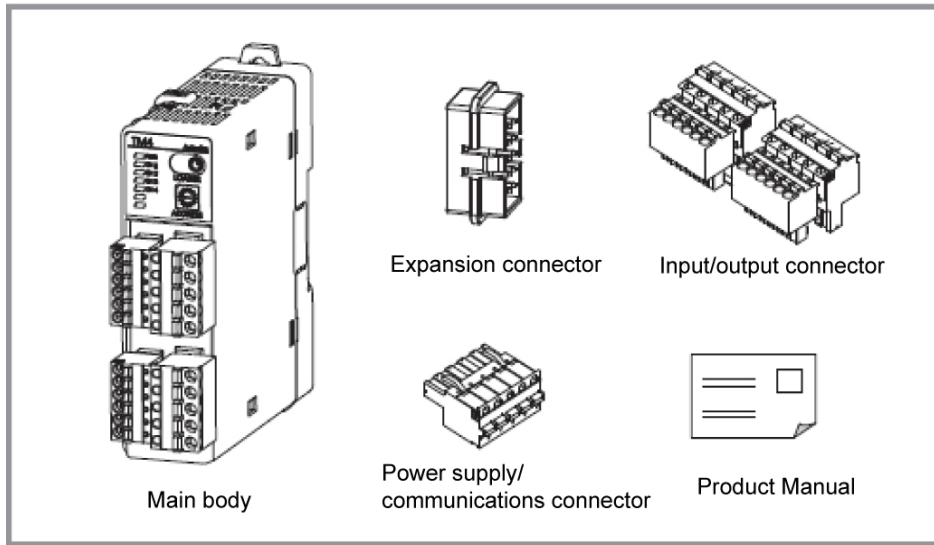



Note

- Make sure all listed components are included with your product before use. If any components are missing or damaged, please contact our sales department or your dealer.
- Note that power supply/communications connectors are provided with basic modules only.

(2) Accessories (sold separately)

- Communication converter

SCM-38I (RS232C to RS485 converter)	SCM-US48I (USB to RS485 converter)	SCM-US (USB to Serial converter)
		

▪ Current transformer(CT)

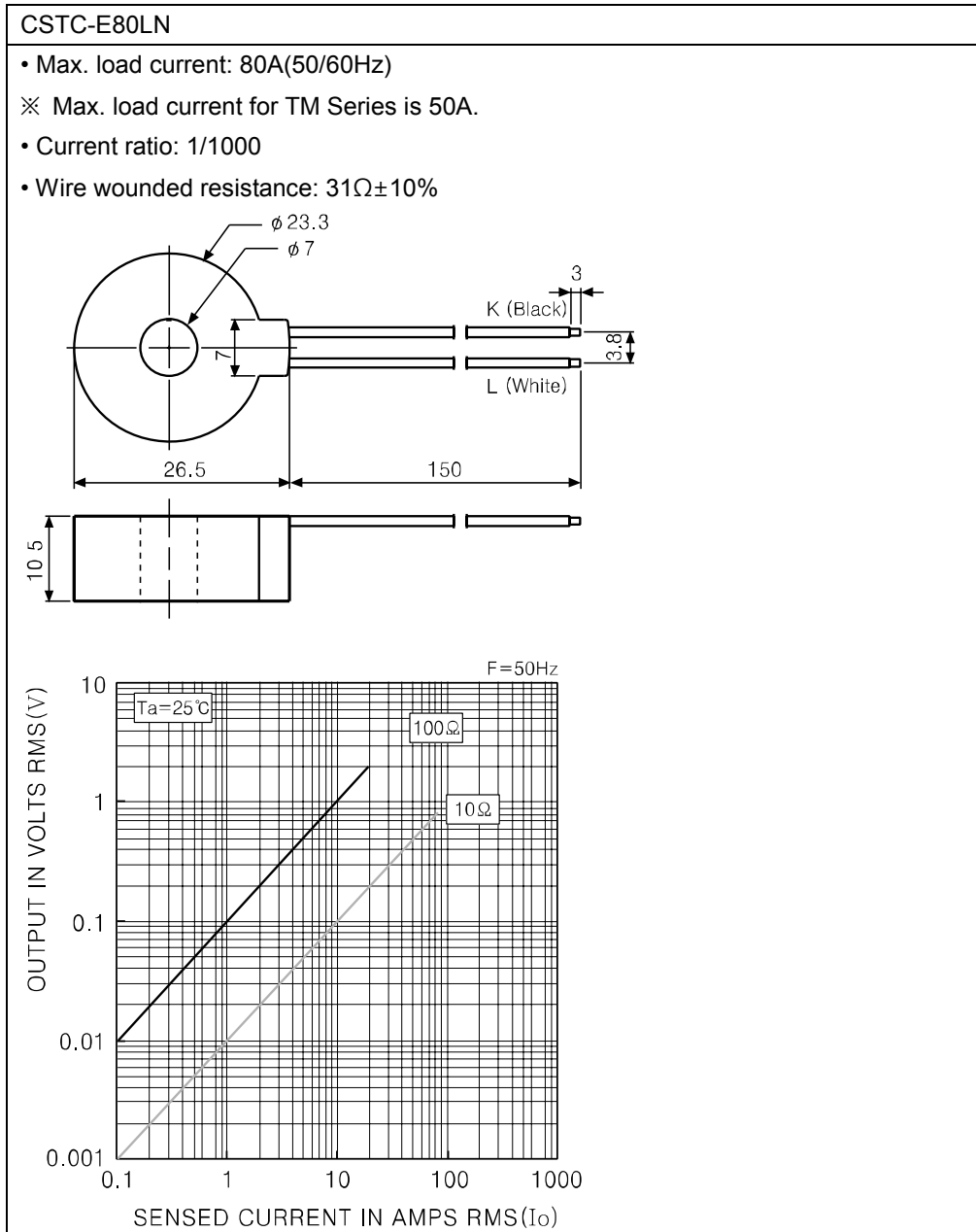

CSTC-E200LN

- Max. load current: 200A(50/60Hz)
- ※ Max. load current for TM Series is 50A.
- Current ratio: 1/1000
- Wire wounded resistance: $20\Omega \pm 10\%$

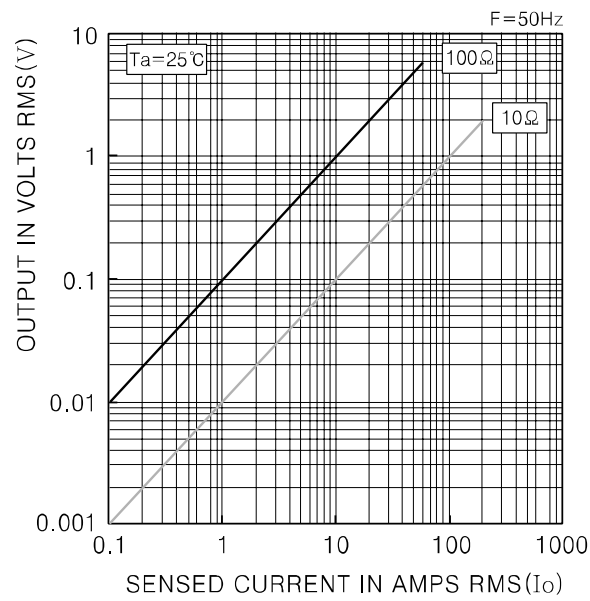
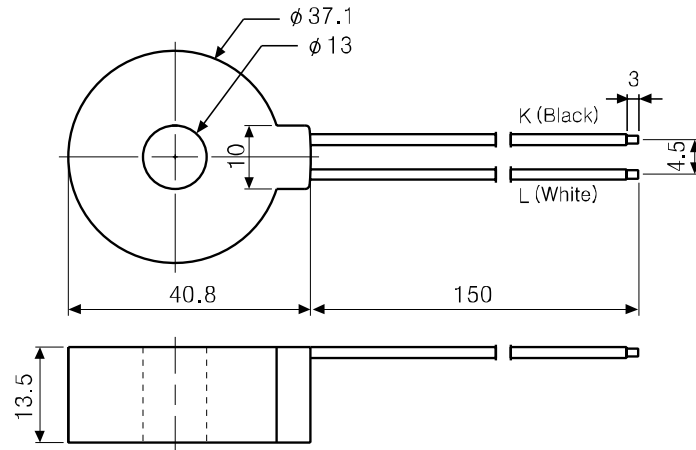

- Display unit

DS/DA-T Series (RS485 communication input type display unit)



Connect RS485 communication input type display unit (DS/DA-T Series) and TM Series, the display unit displays present value of the device without PC/PLC.



Note

- Images of components and accessories may differ from actual products.
- For more information about any of the above products, please refer to the concerned product's user manual. Visit our website (www.autonics.com) to download it.

1.3 Models

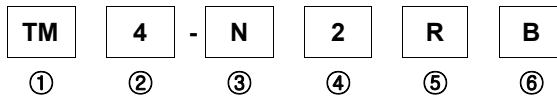

Category		Description	
① Model		TM	Multi-channel modular temperature controller
② Channels		2	2-channel
		4	4-channel
③ Auxiliary input/output	2-channel	2	CT input, Digital input (DI-1, DI-2), Alarm output 1/2, RS485 communication output
		4	CT input, Digital input (DI-1, DI-2), Alarm output 1/2/3/4, RS485 communication output
	4-channel	N	RS485 communication output
④ Power supply		2	24 VDC
⑤ Control output	2-channel	R	Relay output
		C	Selectable current or SSR drive output
	4-channel	R	Relay output
		S	SSR drive output
⑥ Module type		B	Basic module
		E	Expansion module ^{※1}

※1. The expansion module does not supply power/comm. terminal. Order it with the basic module.

1.3.1 Model list and descriptions

	Model Name	Control Output	Option Input/Output		Structure
			Input	Output	
TM2 Series	TM2-22RB	Relay output	CT input, Digital input (DI-1, DI-2)	Alarm 1/2, RS485 comm. output	Basic module
	TM2-22CB	Current or SSR drive output		Alarm 1/2, RS485 comm. output	
	TM2-42RB	Relay output		Alarm 1/2/3/4, RS485 comm. output	
	TM2-42CB	Current or SSR drive output		Alarm 1/2/3/4, RS485 comm. output	
	TM2-22RE	Relay output		Alarm 1/2, RS485 comm. output	Expansion module
	TM2-22CE	Current or SSR drive output		Alarm 1/2, RS485 comm. output	
	TM2-42RE	Relay output		Alarm 1/2/3/4, RS485 comm. output	
	TM2-42CE	Current or SSR drive output		Alarm 1/2/3/4, RS485 comm. output	
TM4 Series	TM4-N2RB	Relay output	-	RS485 comm. output	Basic module
	TM4-N2SB	SSR drive output			
	TM4-N2RE	Relay output			Expansion module
	TM4-N2SE	SSR drive output			

1.4 Parts and features

1.4.1 Front parts

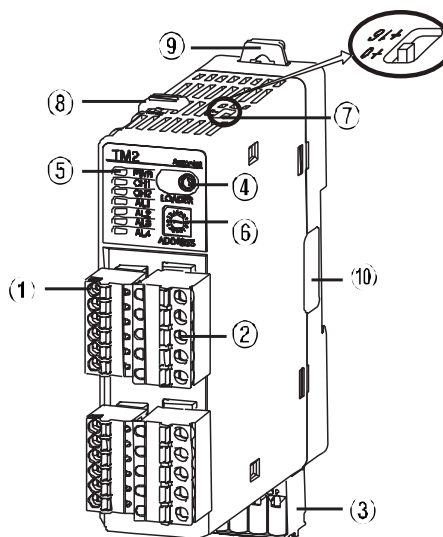

- ① Sensor input connector
- ② Control output connector
- ③ Power/Comm. terminal [only for basic module (TM□-□2□B)]
Supplying power to basic/expansion modules and communicating with over 1 module (s).
- ④ PC loader port:
It is the PC loader port for serial communication between one module and PC to set parameter and monitoring by DAQMaster. Use this for connecting SCM-US (USB to serial converter, sold separately).
※When using PC loader port (connecting SCM-US), communication via power/comm. terminal is blocked and monitoring is not available
- ⑤ Indicators
TM2 Series

Indicator	Status	Initial power ON ^{※1}	Control output	Alarm output				Auto-tuning ^{※2}
				N.O. (Normally Open)		N.C. (Normally Closed)		
				OFF (OPEN)	ON (CLOSE)	OFF (CLOSE)	ON (OPEN)	
PWR (green) ^{※3}	ON	ON	-	-	-	-	ON	
CH1 (red)	Flashes (2,400bps)	ON	-	-	-	-	Flash	
CH2 (red)	Flashes (4,800bps)	ON	-	-	-	-	Flash	
AL1 (yellow)	Flashes (9,600bps)	ON ^{※4}	OFF	ON	OFF	ON	OFF	
AL2 (yellow)	Flashes (19,200bps)	ON ^{※5}	OFF	ON	OFF	ON	OFF	
AL3	Flashes (38,400bps)	-	OFF	ON	OFF	ON	OFF	
AL4	-	-	OFF	ON	OFF	ON	OFF	

⑥ TM4 Series

Indicator	Status	Initial power ON ^{※1}	Control output	Auto-tuning ^{※2}
PWR (green) ^{※3}	ON	ON	ON	ON
CH1 (red)	Flashes (2,400bps)	ON	ON	Flash
CH2 (red)	Flashes (4,800bps)	ON	ON	Flash
CH3 (red)	Flashes (9,600bps)	ON	ON	Flash
CH4 (red)	Flashes (19,200bps)	ON	ON	Flash
-	Flashes (38,400bps)	-	-	-

- ※1. When power is supplied initially, the set communication speed LED flashes for 5 sec.

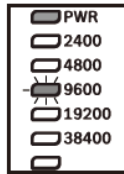





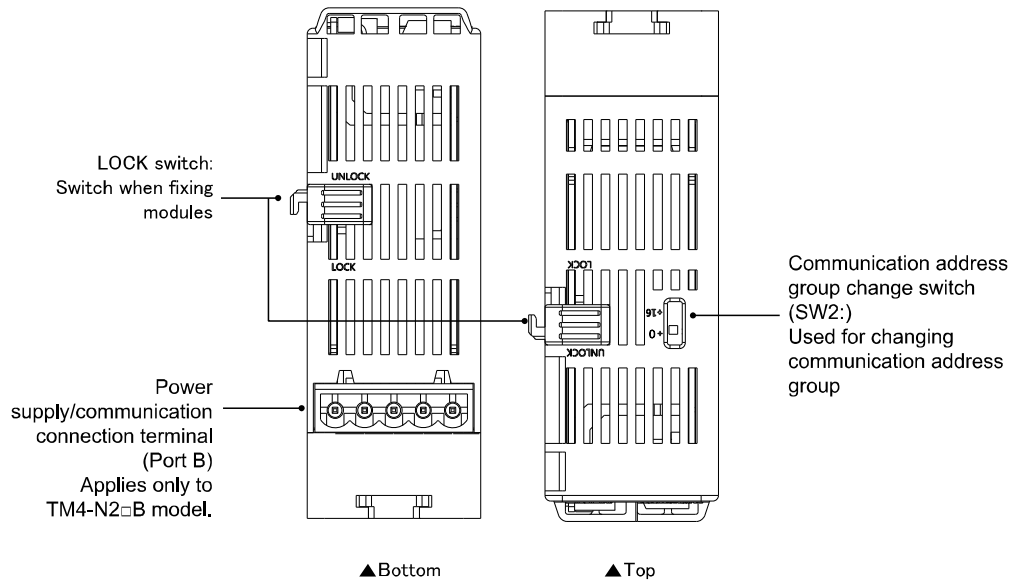
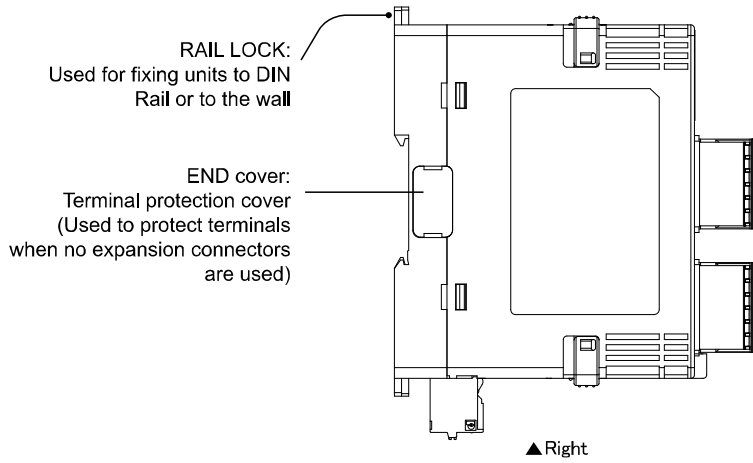

- ※2. The auto-tuning CH□ LED flashes for 1 sec in turn.
- ※3. The PWR LED flashes during communication for 1 sec in turn.
- ※4. Turns ON when CH1 control method is heating & cooling control and cooling output occurs.
(disable AL1 setting)
- ※5. Turns ON when CH2 control method is heating & cooling control and cooling output occurs.
(disable AL2 setting)
- ⑦ Communication address setting switch (SW1): Set the communication address.
 - ⑧ Communication address group switch (SW2): When setting the communication address over 16, select +16.
 - ⑨ Lock switch: Used for fixing modules at top and bottom.
 - ⑩ Rail Lock: Used for installing at DIN rail or using bolts.
 - ⑪ END cover: Remove it when connecting each module to connect an expansion connector.

1.4.2 Other parts



2 Specifications

Series		TM2	TM4
Number of channels		2 channels (insulated each channel – dielectric strength 1,000VAC)	4 channels (insulated each channel – dielectric strength 1,000VAC)
Power supply		24VDC	
Allowable voltage range		90 to 110% of rated voltage	
Power consumption		Max. 5W (for max. load)	
Display method		None- parameter setting and monitoring is available at external devices (PC, PLC, etc.)	
Input type	Thermocouple	K(CA), J(IC), E(CR), T(CC), B(PR), R(PR), S(PR), N(NN), C(TT), G, (TT), L(IC), U(CC), Platinel II	
	RTD	DPt100Ω, JPt100Ω (permissible line resistance max. 5Ω)	
Sampling period		50 ms (2 channel simultaneous sampling)	100 ms (4 channel simultaneous sampling)
Measured accuracy	Thermocouple ^{*1}	(PV ±0.5% or ±1°C, select the higher one) ±1digit max.	
	RTD		
	CT input	±5% F.S. ±1digit max.	-
	Current output	±1.5% F.S. ±1digit max.	-
Influence of temp. ^{*2}	Thermocouple	(PV ±0.5% or ±2°C, select the higher one) ±1digit max.	
	RTD	(Thermocouple input max. -100°C is within ±5°C) ●Thermocouple B, R, S, C, G, L, U: (PV ±0.5% or ±5°C, select the higher one) ±1digit max.	
Control Output	Relay	250VAC 3A 1a	
	SSR	Max. 12VDC ±3V 30mA	Max. 22VDC ±3V 30mA
	Current	Selectable DC 4-20mA or DC 0-20mA (load resistance max. 500Ω)	-
Control type	Heating, Cooling	ON/OFF control, P, PI, PD, PID control	
	Heating & Cooling		
Option output	Alarm	250VAC 3A 1a	-
	Communication	RS485 communication output (Modbus RTU method)	
Option input	CT input	0.0-50.0A (primary current measurement range) ※CT ratio: 1/1000	-
	Digital input	<ul style="list-style-type: none"> ● Contact input: ON max. 1kΩ, OFF min. 100kΩ ● Solid-state input: ON residual voltage max. 1.5V, OFF leakage current max. 0.1mA ● Outflow current: Approx. 0.5mA per input 	-
Hysteresis		1 to 100°C/°F (0.1 to 100.0°C/°F) variable	
Proportional band (P)		0.1 to 999.9°C/°F	
Integral time (I)		0 to 9999 sec.	

Series		TM2	TM4
Derivative time (D)		0 to 9999 sec.	
Control period		0.1 to 120.0 sec. (only relay and, SSR drive output type)	
Manual reset		0.0 to 100.0%	
Relay life cycle	Mechanical	Min. 10,000,000 operations	
	Electrical	Min. 100,000 operations (250VAC 3 A resistance load)	
Insulation resistance		100 MΩ (at 500VDC megger)	
Insulation type		Double insulation or reinforced insulation (mark:  , dielectric strength between measurement part and power part: 1kV)	
Dielectric strength		1,000VAC 50/60Hz for 1 min. (between input terminals and power terminals)	
Vibration		0.75mm amplitude at frequency of 5 to 55Hz (for 1 min.) in each X, Y, Z direction for 2 hours	
Noise resistance		±0.5kV the square wave noise (pulse width: 1 μs) by the noise simulator	
Environment	Ambient temperature	-10 to 50°C, Storage: -20 to 60°C	
	Ambient humidity	35 to 85%RH, Storage: 35 to 85%RH	
Accessories		Expansion connector: 1, Power/Comm. connector: 1 (only for basic module)	
Approval		    	
Weight*3	Basic module	Approx. 217g (Approx. 152g)	Approx. 239g (Approx. 174g)
	Expansion module	Approx. 208g (Approx. 143g)	Approx. 231g (Approx. 166g)

※1. In case of thermocouple K, J, E, T, N, it is below -100°C and L, U, Platinel II, it is below ±2°C ±1digit.

In case of thermocouple B, display accuracy cannot be ensured under 400°C.

In case of thermocouple R, S, it is below 200°C and C, G, it is max. 3°C ±1digit.

※2. Applied when it is for out of room temperature (23±5°C) range.

※3. The weight includes packaging. The weight in parentheses is for unit only.

※Environment resistance is rated at no freezing or condensation.

3 Dimensions

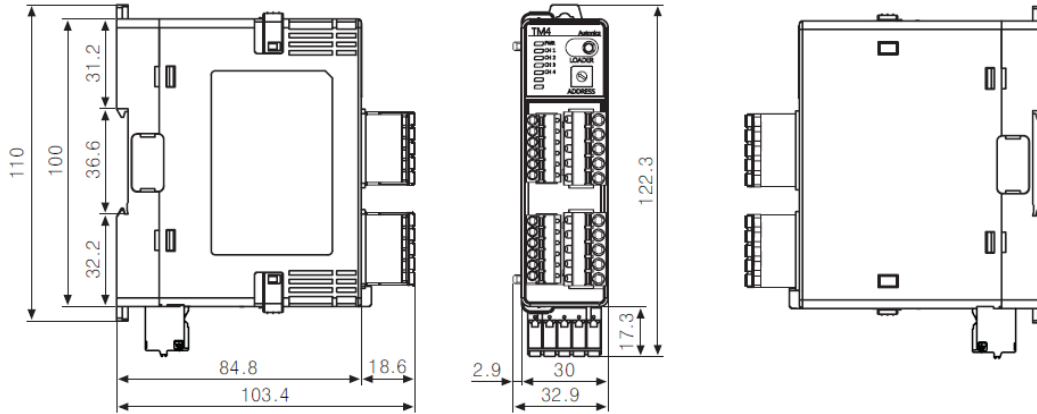

Note

Expansion modules do not have a power supply/communications connection terminal at the bottom.

3.1 Installation

3.1.1 Connector connection

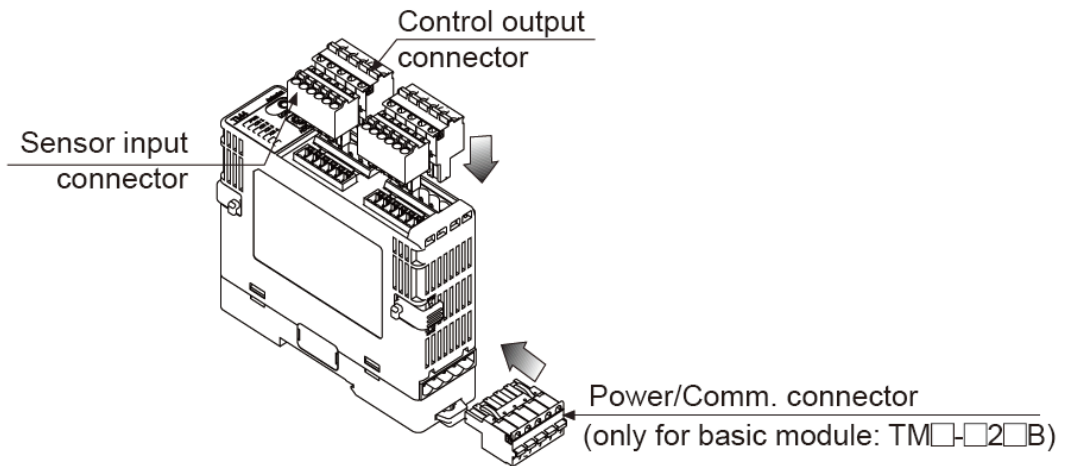

Note

Expansion modules do not have a power supply/communications connection terminal.

3.1.2 Module connection

TM Series allows simultaneous monitoring for multi channel I/O with connecting Multiple modules using module expansion connectors. Connect expansion modules to a basic module. Basic module can be placed in any position among multiple module sets. Remove the cover.

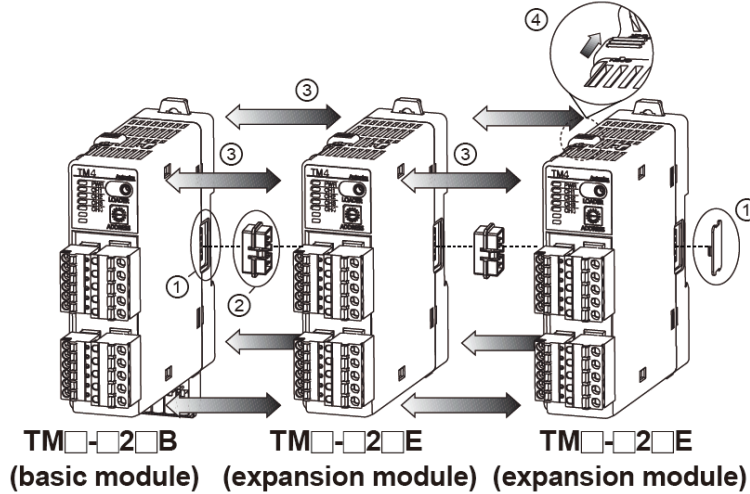

- 1st Remove each module's END covers. (do not remove at the ends of END covers)
- 2nd Connect expansion connectors between modules.
- 3rd Push each modules. (max. 30 units)
- 4th Push the lock switch to lock direction.



Note

- Supply adequate power for power input specifications and overall capacity. (Max. power when connecting 31 modules: 31 units×5W=155W)
- Install the units vertically.

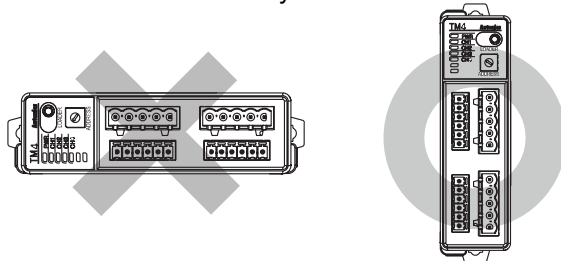

- Use end plates (sold separately, not available from Autonics) to fix firmly.

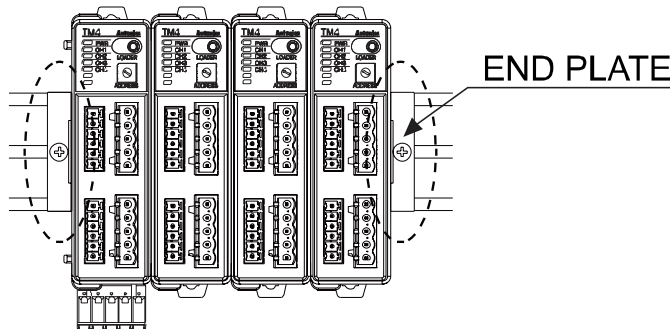

3.1.3 Mounting with bolts

1st Pull each rail lock to up and down.

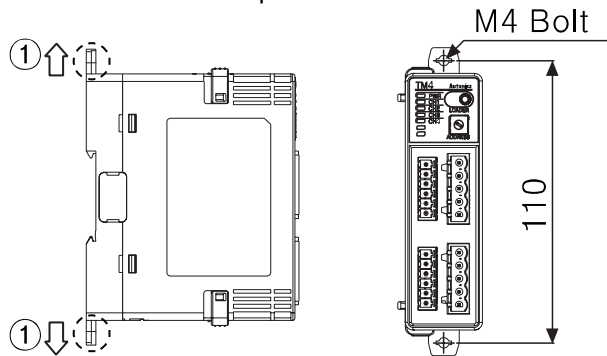

2nd Insert bolts to fix it on rail lock. (fixing torque is 0.5 to 0.9 N·m).

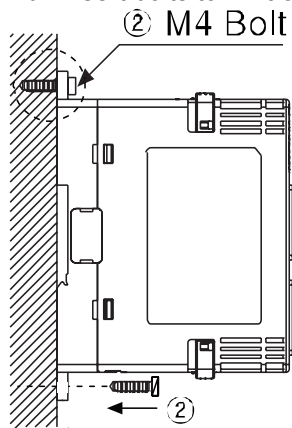

3.1.4 Mounting on DIN rail

(1) Installation/Removal method of a single module

- Installing

1st Hang the top rail lock to DIN rail.

2nd Push and press the module to down direction.

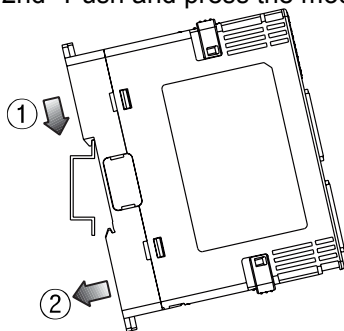

- Removing

1st Press the module to down direction.

2nd Pull the module body forward.

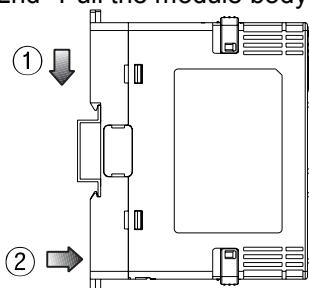

(2) Installation/Removal method of multiple modules

- Installing

1st Pull each rail lock switch up and down.

2nd Mount the module body to the DIN rail and then push the rail lock in.

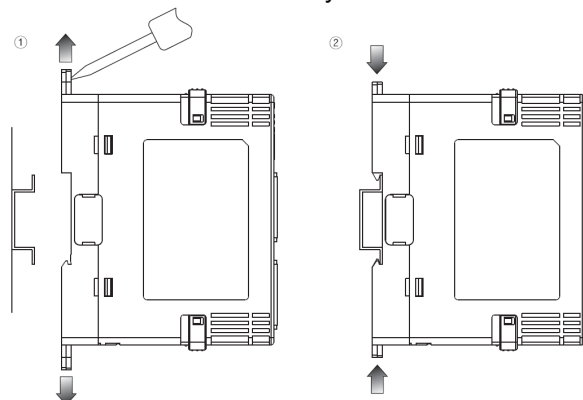

- Removing

1st Pull each rail lock switch up and down.

2nd Remove the body from the DIN rail.

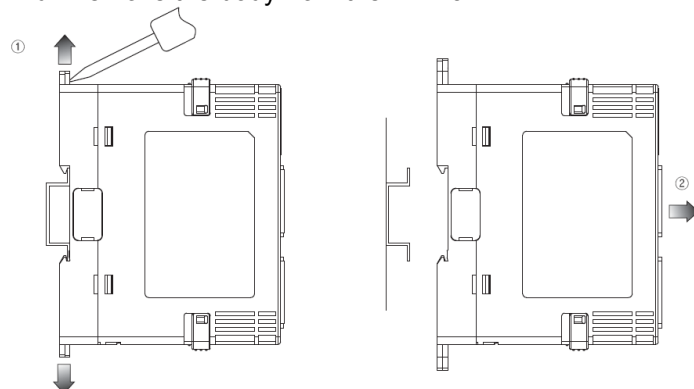

4 Connections and Insulation Block Diagram

4.1 TM2 Series

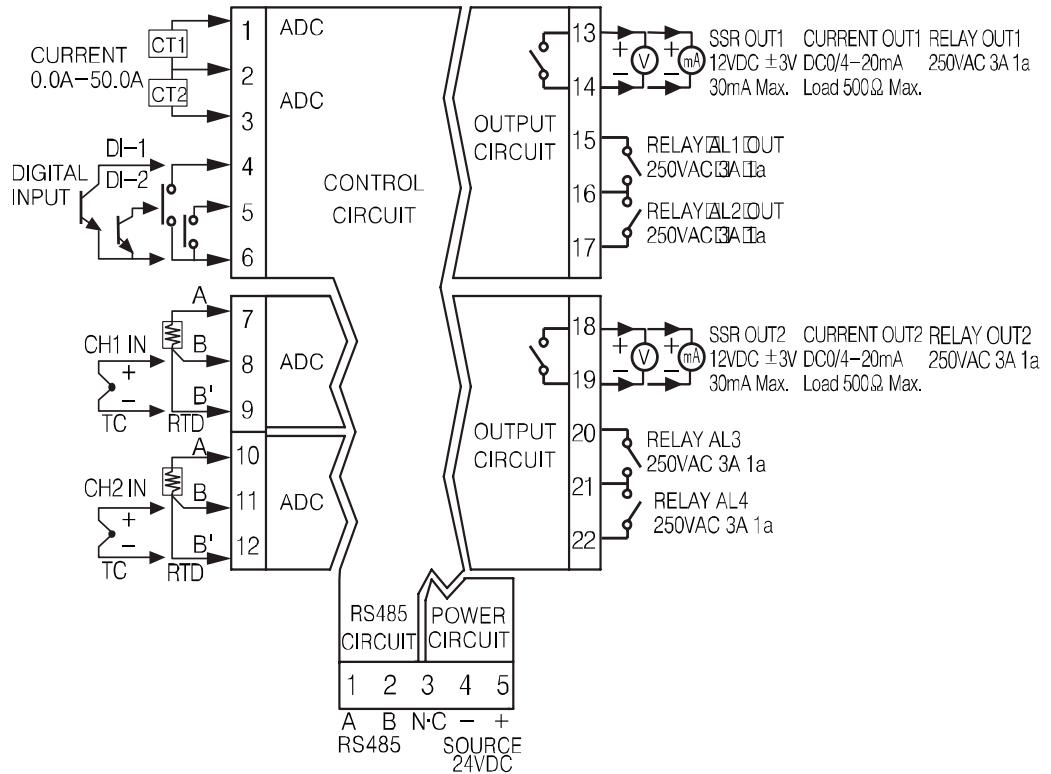

※ Relay AL3/AL4 OUT are available only for TM2-42□□ models.

- Power/Comm. connection terminal [Only for basic module: TM□-□□□B]

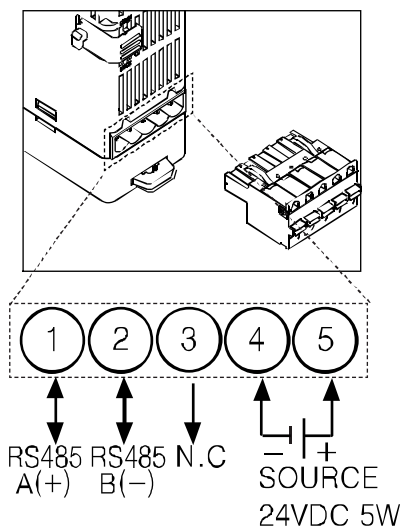

4.2 TM4 Series

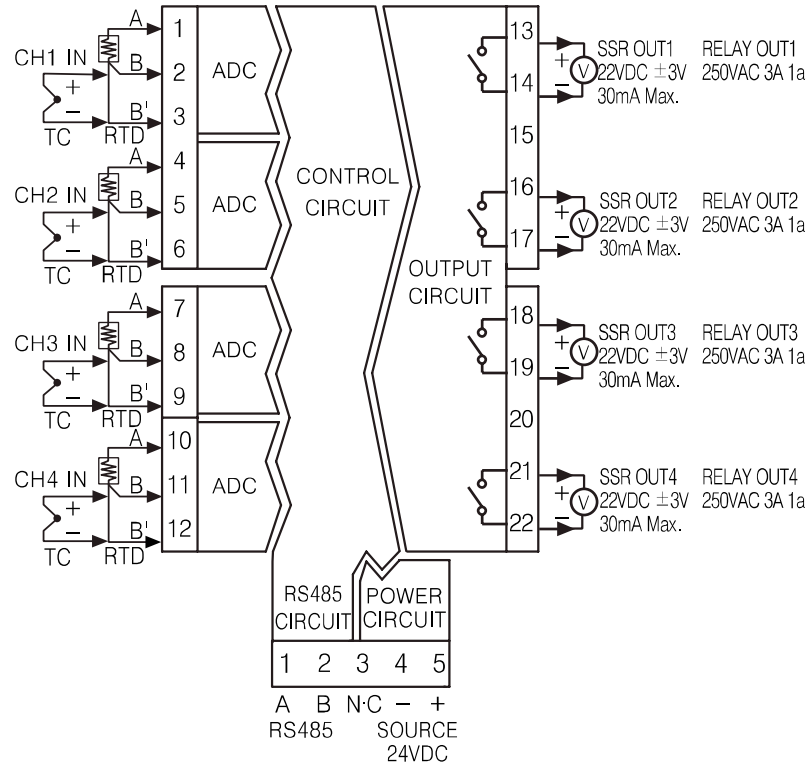

- Power/Comm. connection terminal [Only for basic module: TM□-□□□B]

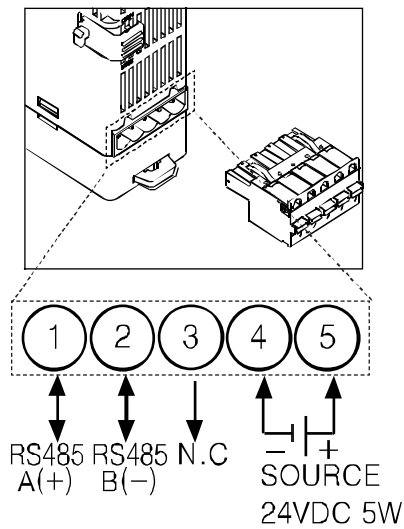

Note

- Pay attention to the connection direction when wiring the power supply/communications connection terminal.
- It is recommended to use lines with AWG28 to 16 when connecting the sensor or compensation wire.
- It is recommended to use lines thicker than AWG24 for SSR drive output.
- It is recommended to use lines thicker than AWG20 for relay output.

4.3 Wiring precautions

- Mixing up the input terminals with output terminals and vice versa can lead to product damage.
- Use only sensors supported by the product.
- Make sure to connect rated SSRs or loads to the output terminals.
- Make sure to connect the communication cable with correct communication terminals (A, B).
- Make sure to observe correct polarity of power source terminals. (+ and -).

4.3.1 Sensor connection

(1) Compensation wire connection

For thermocouple sensors, use compensation wire of the same specification as input sensors. Using an extension wire of different specification and/or material will increase inaccuracy of temperature sensing. It is recommended to choose high performance compensation wire for more reliable sensing.

(2) Measurement error

- Do not mix up the direction of the input sensor connector.
- Carefully adjust both load and sensor positions.
- Make sure the sensor is securely attached to the input connector.

(3) Wiring with AC power lines

Do not put the sensor lines in close proximity of the AC power lines.

(4) Input sensor (or compensating lead wires) connection

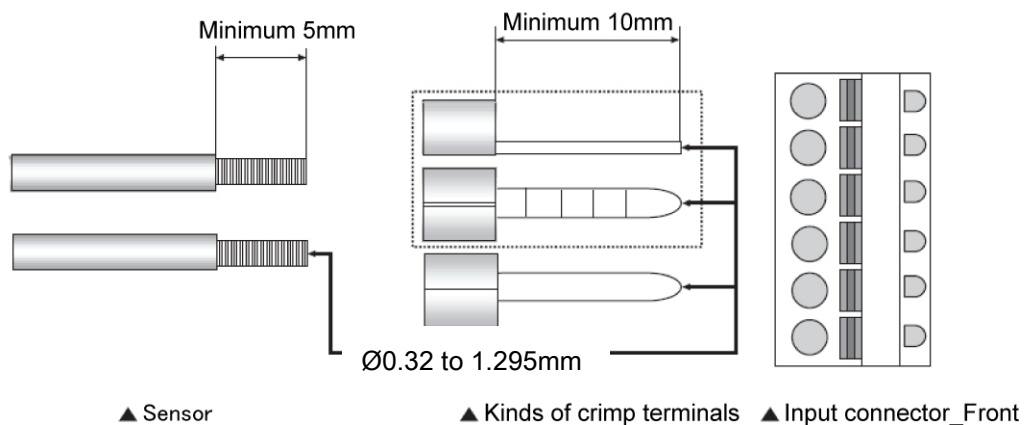

Note

- Make sure the sensor is completely inserted in the connector using a crimped terminal.
- The sensor and crimp terminal to attach at the input connector must be AWG28 to 16 (Ø 0.32 to 1.295 mm).
- Fix the sensor to the connector properly for accurate measurement.

4.3.2 Power supply connection

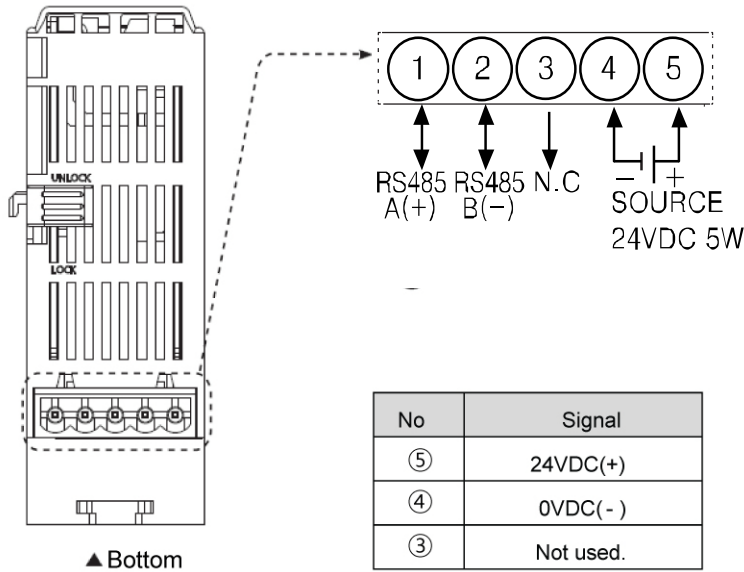

Note

- Use power line with AWG24 to 12.
- Calculate the total power consumption first and then connect a power supply system of appropriate capacity.

4.3.3 Communication line wiring

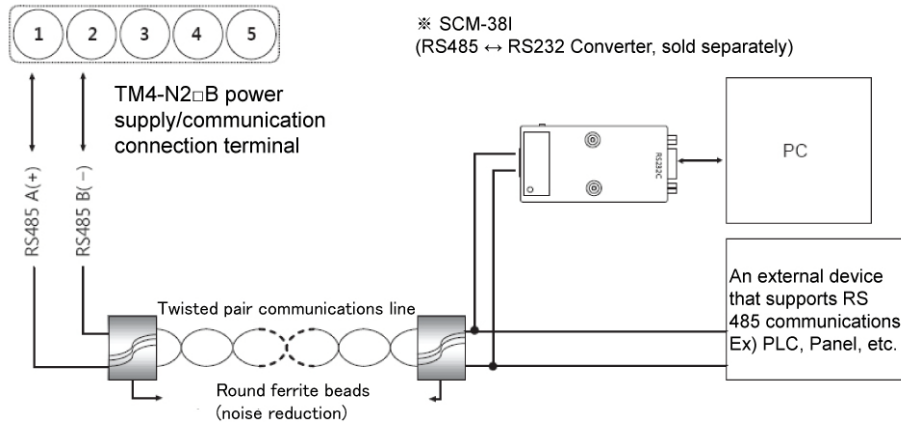

Note

- Do not tie the communications line together with the AC power line.
- Use twisted pair cables for the communications line only.
- Do not allow the communication line to exceed 800m in length.
- For further details, please refer to '6.5 Communications'.

4.3.4 Module connection

(1) Basic module positioning

The basic module can be mounted anywhere in the connected group. It works regardless of communication address.

Basic module

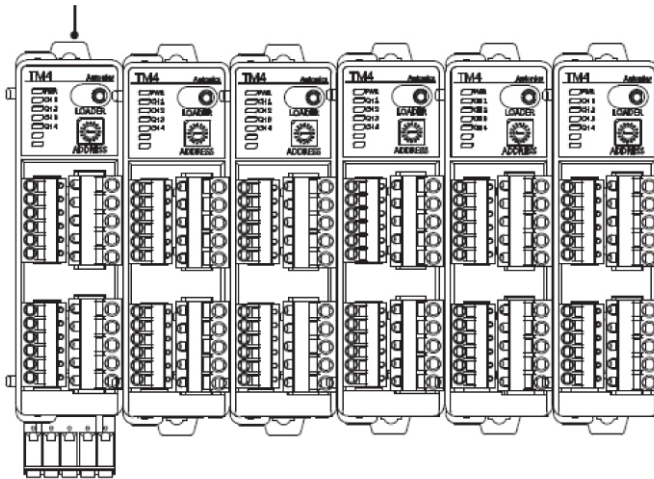

Basic module

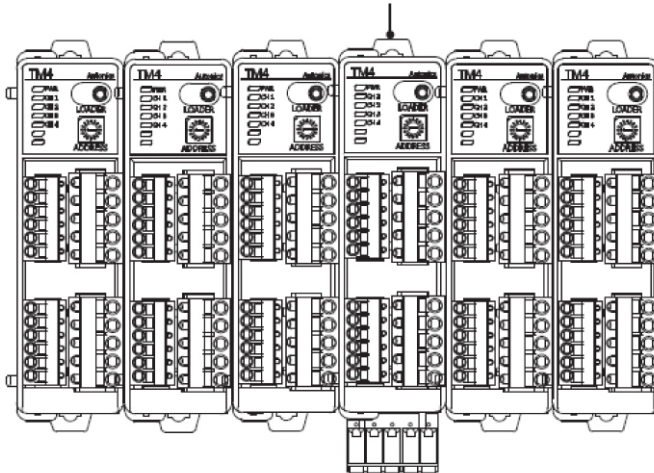

(2) Module Expansion

When using the bottom power supply/communication connection terminal (Power/Comm. connection terminal), up to 31 modules can be connected at the same time.

Maximum required power = 31 X 5 W = 155 W

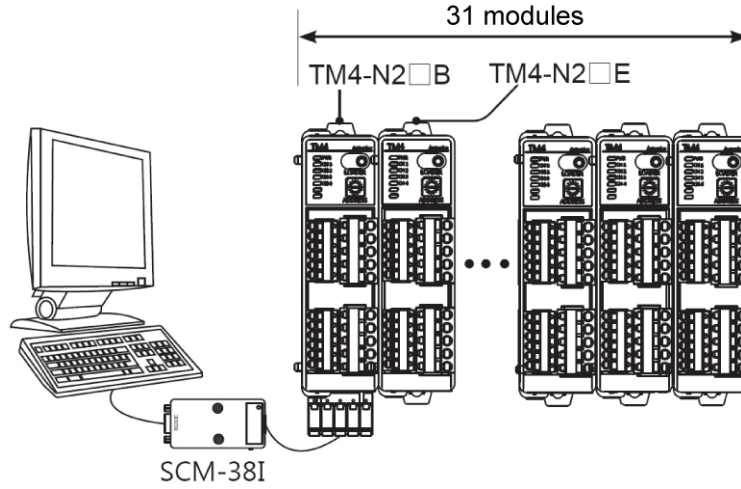

When connecting several module sets (31 modules or less), each module set requires separate power supply.

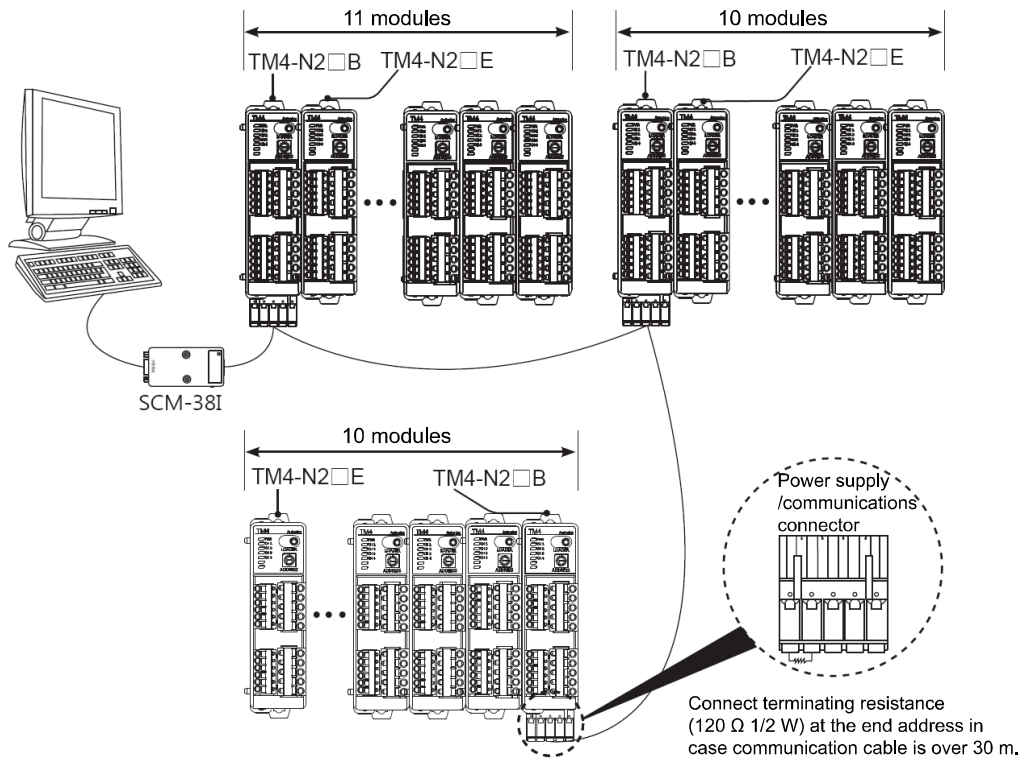

5 Preparation and Startup

5.1 General process

Before operating TM Series for the first time, do the following:

- 1st Connect all external devices, sensor and load to the TM Series.
- 2nd Set parameter values through external connecting devices (PC loader program, GP etc.).
- 3rd Download the parameters to TM Series.
- 4th Proceed with auto-tuning or set control variables, and then start control.



Note

For using comprehensive device management program 'DAQMaster, parameters are automatically downloaded at the time when they are changed.

5.2 Setup values when power ON

Setting category	Factory default	Previous setting value	Power ON setting value
Auto/Manual	Auto	Auto	Auto
		Manual	Manual
RUN/STOP	RUN	RUN	RUN
		STOP	STOP
PID/ONOFF	PID	PID	Maintains preset value
		ONOFF	Maintains preset value
MV	0.0	Preset MV	Maintains preset value
	0.0	Stop MV	Maintains preset value
	0.0	Sensor Error MV	Maintains preset value

5.3 Temperature control examples

5.3.1 Single module

(1) TM4-N2RB model (relay output)

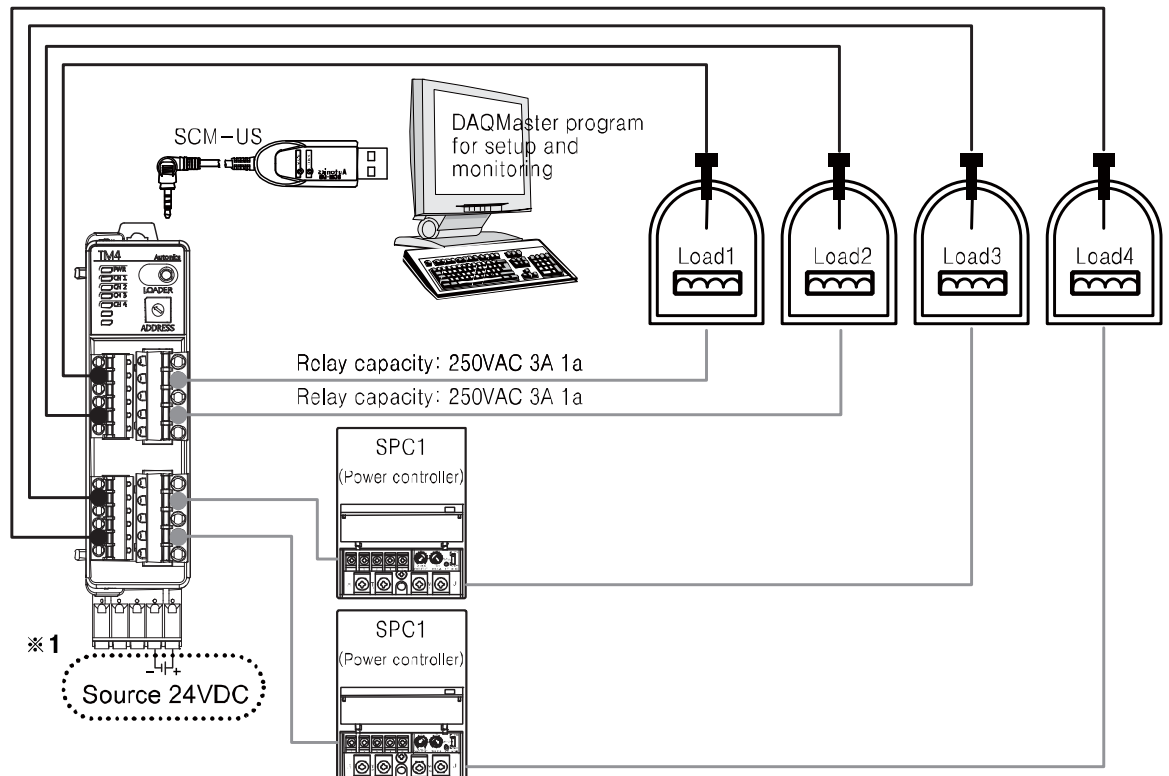

※1. Using SCM-US enables only setting parameter. To monitor and control temperature requires the additional 24VDC power supply.

Caution

Do not connect SCM-US and RS485 communications cables at the bottom at the same time.

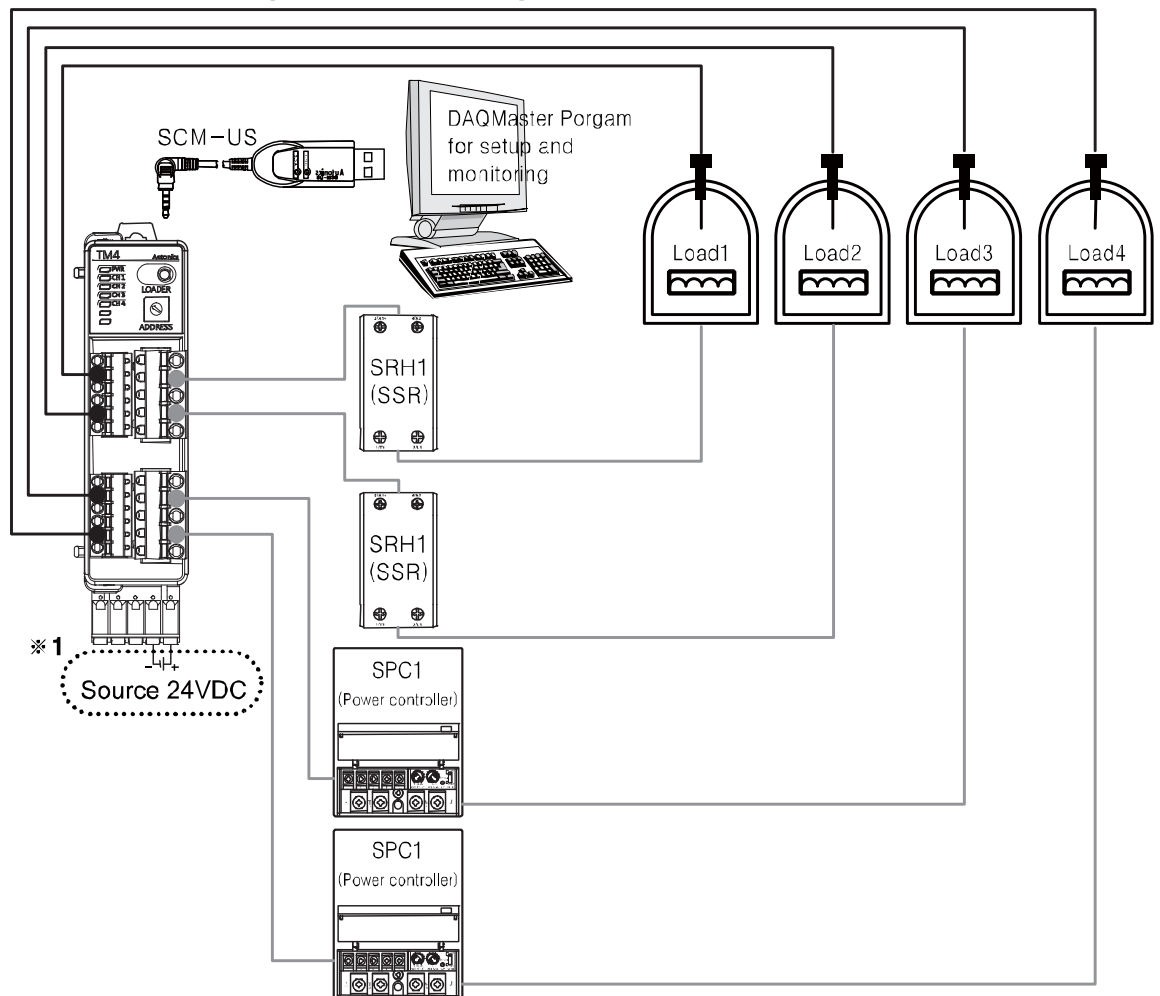
(2) TM4-N2SB model (SSR drive output)

- ※1. Using SCM-US enables only setting parameter. To monitor and control temperature requires the additional 24VDC power supply.

**Caution**

- Do not connect SCM-US and RS485 communications cables at the bottom at the same time.
- Use an isolated type SSR.

5.3.2 Multiple modules

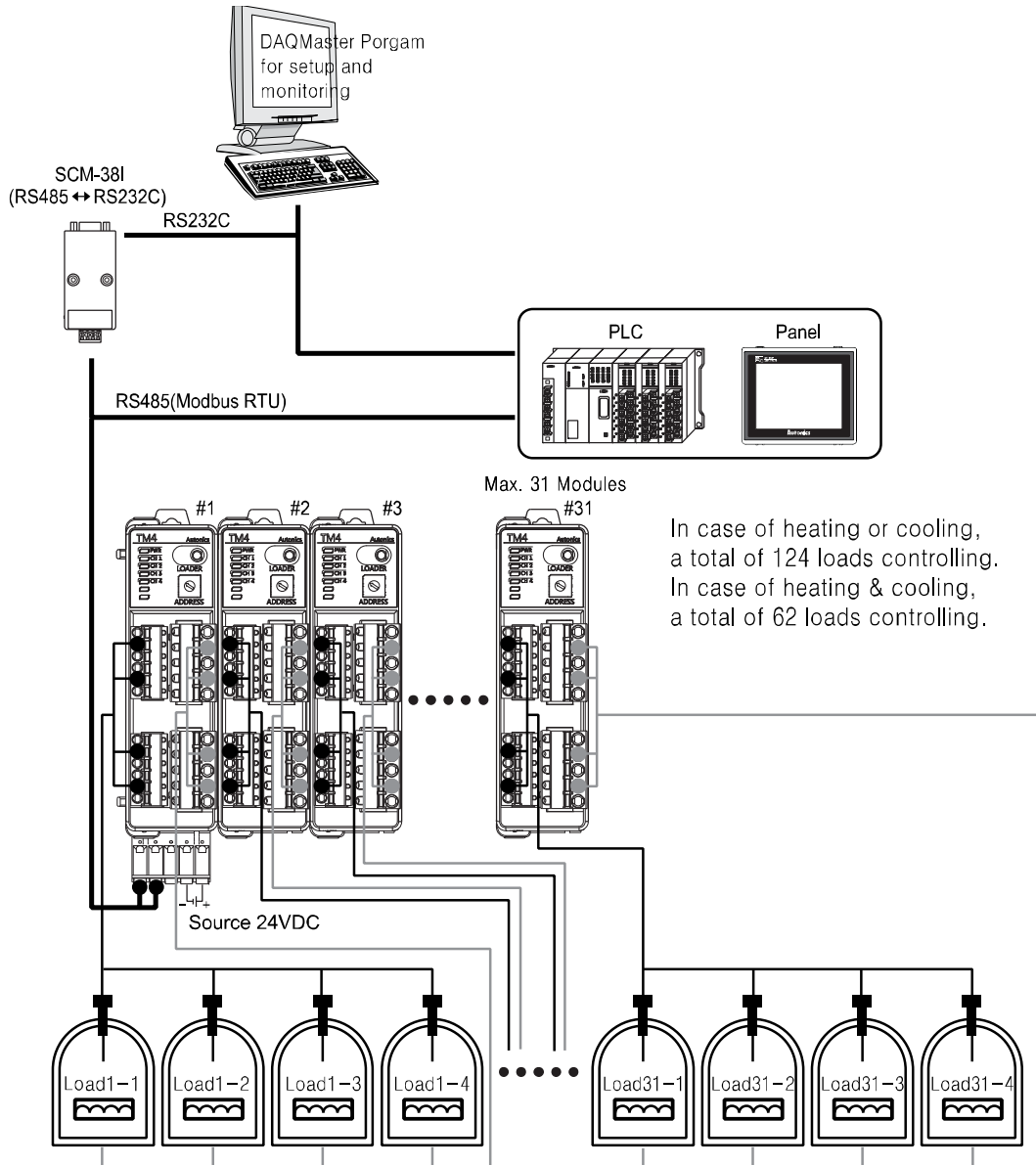

6 Parameter Settings and Functions

6.1 Input

6.1.1 Input type and temperature range

Input Type		No.	Decimal point	Indicator	Temperature range (°C)	Temperature range (°F)
Thermocouples	K(CA)	0	1	K(CA).H	-200 to 1350	-328 to 2462
		1	0.1	K(CA).L	-200.0 to 1350.0	-328.0 to 2462.0
	J(IC)	2	1	J(IC).H	-200 to 800	-328 to 1472
		3	0.1	J(IC).L	-200.0 to 800.0	-328.0 to 1472.0
	E(CR)	4	1	E(CR).H	-200 to 800	-328 to 1472
		5	0.1	E(CR).L	-200.0 to 800.0	-328.0 to 1472.0
	T(CC)	6	1	T(CC).H	-200 to 400	-328 to 752
		7	0.1	T(CC).L	-200.0 to 400.0	-328.0 to 752.0
	B(PR)	8	1	B(PR)	0 to 1800	32 to 3272
	R(PR)	9	1	R(PR)	0 to 1750	32 to 3182
	S(PR)	10	1	S(PR)	0 to 1750	32 to 3182
	N(NN)	11	1	N(NN)	-200 to 1300	-328 to 2372
	C(TT) ※ ¹	12	1	C(TT)	0 to 2300	32 to 4172
	G(TT) ※ ²	13	1	G(TT)	0 to 2300	32 to 4172
	L(IC)	14	1	L(IC).H	-200 to 900	-328 to 1652
		15	0.1	L(IC).L	-200.0 to 900.0	-328.0 to 1652.0
U(CC)	16	1	U(CC).H	-200 to 400	-328 to 752	
	17	0.1	U(CC).L	-200.0 to 400.0	-328.0 to 752.0	
Platinel II	18	1	PLII	0 to 1400	32 to 2552	
Platinum Resistance Temperature Detector (RTD)	JPt100 Ω	19	1	JPt100.H	-200 to 600	-328 to 1112
		20	0.1	JPt100 .L	-200.0 to 600.0	-328.0 to 1112.0
	DPt100 Ω	21	1	DPt100.H	-200 to 600	-328 to 1112
		22	0.1	DPt100. L	-200.0 to 600.0	-328.0 to 1112.0

※1. C(TT): Same as existing W5(TT) type temperature sensor/

※2. G(TT) : Same as existing W(TT) type temperature sensor.

- Temperature sensors convert subject temperature to electrical signals for the temperature controller, allowing it to control output.
- SV (setting value) can only be set within the input range.

6.1.2 Input type

This product supports multiple input types, making it possible for the user to choose from thermocouples, resistors, and analog voltage/current. Different sensors can be designated to each channel.



Ex.

CH1 input type = KCA.H, CH2 input type = JIC.H

Setting group	Parameter	Setting range	Factory default	Unit
Initial Setting	Input Type	Refer to 6.1.1 Input type and temperature range	K(CA).H	-



Note

- When changing input type settings, the high-limit and low-limit values of SV are automatically changed to max/min values of operational temperature range of the modified input type. You must reset these values. (SV, Multi SV No, SV-0 to SV-3 and input correction are initialized.) However, measurement units remain the same.
- If the measured value is out of the input range, external device displays HHHH (high-limit), LLLL (low-limit) and displays OPEN when the sensor is not connected.

6.1.3 Input temperature sensor unit

When selecting the temperature sensor input options, you can set the desired units of operation temperature/display temperature.

Setting group	Parameter	Setting range	Factory default	Unit
Initial Setting	Unit	°C, °F	°C	-



Note

When modifying the temperature units, setting values of the related parameters remain the same as the existing values, and SV, Multi SV No., SV-0 to SV-3, SV high-limit/low-limit, and input correction will be initialized.

6.1.4 Input correction

This feature is used to compensate for input correction produced by thermocouples, RTDs, or analog input devices, but NOT by the controller itself.

The input correction adjustments function is mainly used when the sensor cannot be attached directly to control object. It is also used to compensate for temperature variance between the sensor's installation point and the actual measuring point.

Setting group	Parameter	Setting range	Factory default	Unit
Initial Setting	Input Bias	-999 to 999 (H) -999.9 to 999.9 (L)	0	Digit



Ex.

If the controller displays 78°C when the actual temperature is 80°C, set the input correction to 2 in order to adjust the controller's display temperature to 80°C.



Note

- Make sure that an accurate temperature variance measurement is taken before setting values of Input Correction. An inaccurate initial measurement can lead to greater variance.
- Many of today's temperature sensors are graded by their sensitivity. Since higher accuracy usually comes at a higher cost, most people tend to choose sensors with medium sensitivity. Measuring each sensor's sensitivity correction and using the Input Correction feature for correction can ensure higher accuracy in temperature reading.

6.1.5 Input digital filter

It is not possible to perform high accuracy control if the PV (present value) fluctuates because of noise elements, disturbance, or instabilities in the input signal. Using the Input Digital Filter function can stabilize PV to realize more reliable control.

Setting group	Parameter	Setting range	Factory default	Unit
Initial Setting	Digital Filter	0.1 to 120.0	0.1	Sec.



Ex.

When the Input Digital Filter is set to 0.4 seconds, the digital filter is applied according to a sampling value collected over 0.4 seconds (400ms).



Note

When the Input Digital Filter is used, PV (present value) can vary from the actual input value.

6.1.6 SV high/low-limit value

You can limit the SV (setting value) range within the temperature range of the sensor or analog input type (refer to 6.1.1 Input type and temperature range) in order to prevent the system from controlling with improper SV.

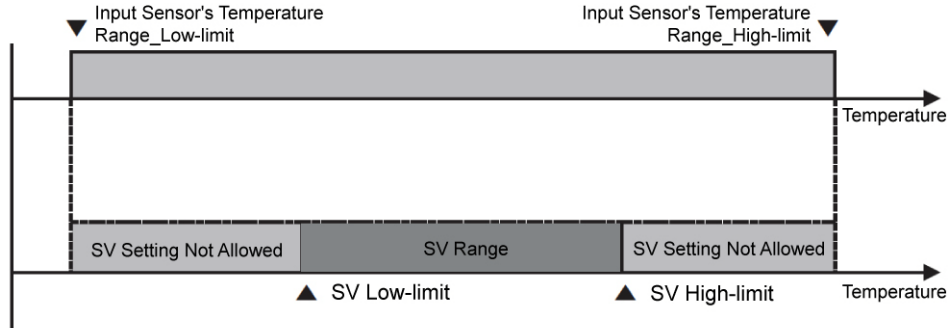

Setting group	Parameter	Setting range	Factory default	Unit
Initial Setting	SV High-limit	Refer to the below.	1350	°C/°F
	SV Low-limit		-200	

- SV low-limit value: Min. value of input sensor range to SV high-limit - 1 digit
- SV high-limit value: SV low-limit + 1 digit to max. value of input sensor range



Note

- Attempts to set the limits outside the min/max input range, or analog's high/low-limits, are not accepted. Instead, the previous settings are retained.
- SV (setting value) can only be set within the SV low-limit and SV high-limit.
- SV low-limit cannot exceed SV high-limit.
- Changing the input sensors automatically changes the SV high/low-limit settings to max/min values of the changed input sensor input. The user is required to reset related settings.

6.2 Control output

6.2.1 Control output operation mode

Control output modes for general temperature control include heating, cooling, and heating and cooling.

Heating control and cooling control are mutually opposing operations with inverse outputs.

The PID time constant varies based on the controlled objects during PID control.

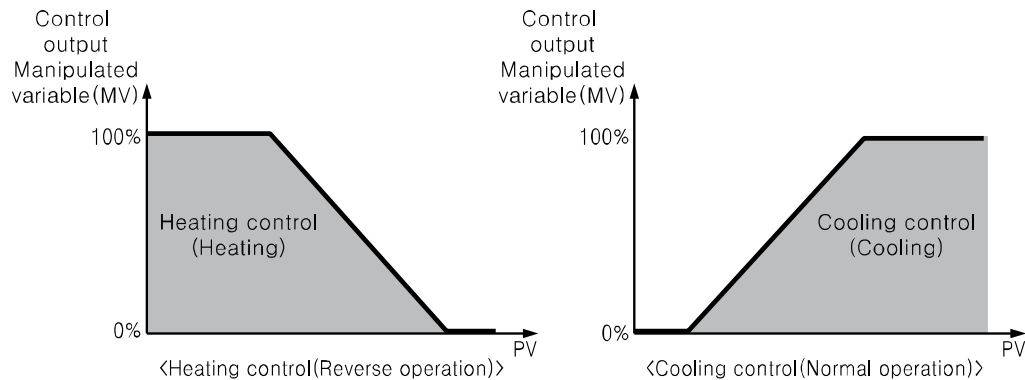

Setting group	Parameter	Setting range	Factory default	Unit
Initial Setting	Operating Type	HEATING, COOLING HEATING & COOLING	HEATING	-

(1) Heating control

Heating control mode: the output will be provided in order to supply power to the load (heater) if PV (present value) falls below SV (setting value).

(2) Cooling control

Cooling control mode: the output will be provided in order to supply power to the load (cooler) if PV (present value) rises above SV (setting value).

(3) Heating and cooling control

Heating and cooling control mode: heating and cooling with a single temperature controller when it is difficult to control subject temperature with only heating or cooling.

Heating and cooling control mode controls the object using different PID time constants for each heating and cooling. It is also possible to set heating and cooling control in both PID control or ON/OFF control mode. Heating/cooling output can be selected among Relay output, SSR drive voltage output and current output depending on model types chosen according to your application environment. (Note that only standard SSR control is available for SSR drive output in OUT2.)

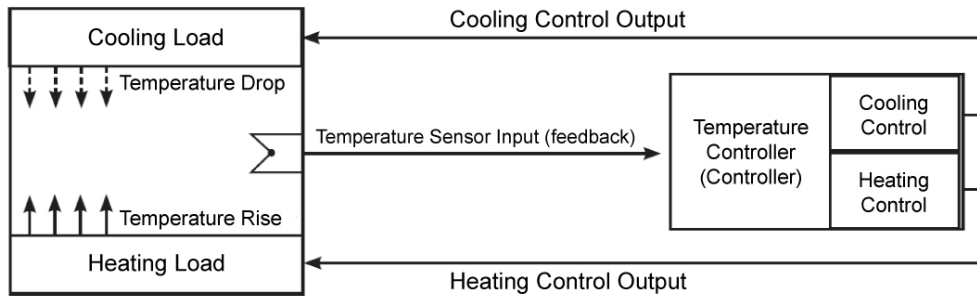

- For heating/cooling control, each output for heating and cooling is automatically allocated as described in the following table.

Series	Heating control	Cooling control	Remarks
TM4	CH1 OUT	CH2 OUT	Heating output: Selectable control output by model Cooling output: Selectable control output by model
	CH3 OUT	CH4 OUT	
TM2	CH1 OUT	AL1 OUT	Heating output: Selectable control output by model Cooling output: Relay output fixed
	CH2 OUT	AL2 OUT	



Note

For TM2 Series, heating output can be selected by models from relay output, SSR drive output and current output. Cooling output is fixed to relay output.

6.2.2 Deadband/Overlap band

In heating and cooling control, it is possible to designate a deadband between heating and cooling control bands based on SV (setting value).

- A deadband forms around the SV when DB is set to a positive value. No control occurs in the deadband area. Therefore, heating and cooling MVs become 0.0% in the formed deadband.
- An overlap band (simultaneous application of heating and cooling MVs) forms around the SV when DB is set to a negative value.

Setting group	Preceding condition	Parameter	Setting range	Factory default	Unit
Control Operation	PID-PID PID-ON/OFF ON/OFF-PID	Dead_Overlap band	-P BAND to +P BAND	0.0	Digit
	ON/OFF-ON/OFF		-999 to 0 to 999 (H) -999.9 to 0 to 999.9 (L)	0	

- Set deadband to 0 when a deadband or an overlap band is not used.



Note

- When proportional bands are different, the smaller one takes precedence.
- Input sensor (H, L) setting determines the use of a decimal point.

(1) Using Deadband

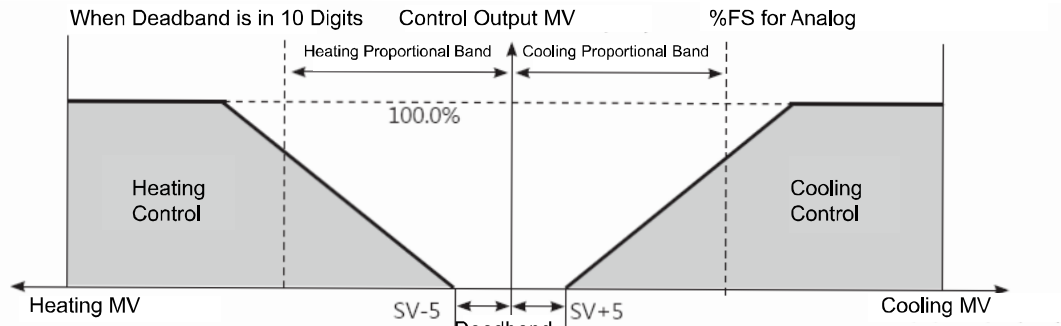

<PID-PID Control with Heating and Cooling Control>

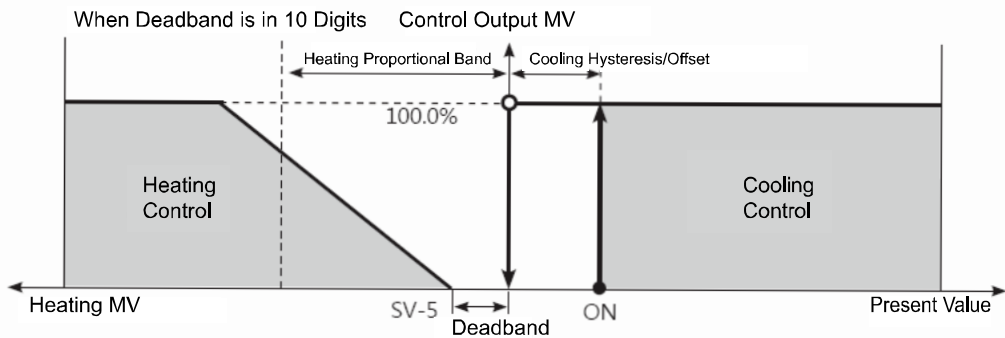

<PID-ON/OFF Control with Heating and Cooling Control>

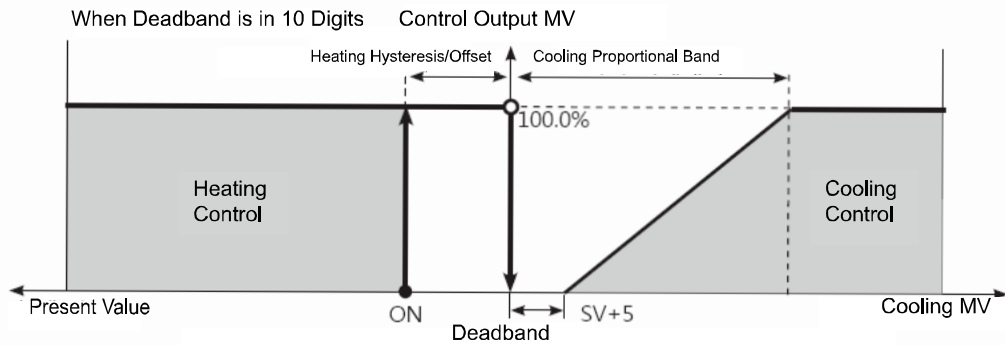

<ON/OFF-PID Control with Heating and Cooling Control>

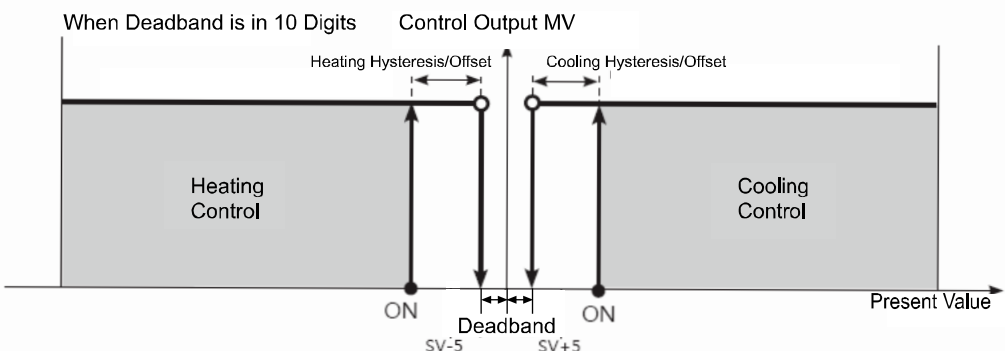

<ON/OFF-ON/OFF Control with Heating and Cooling Control>

(2) Using Overlap band

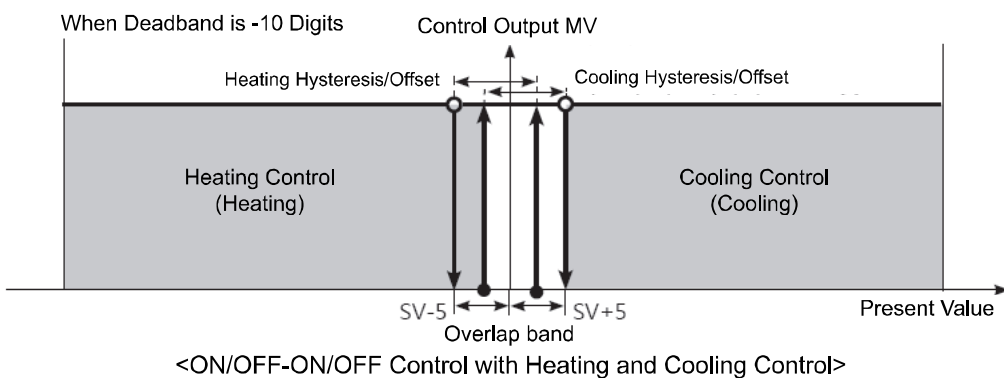
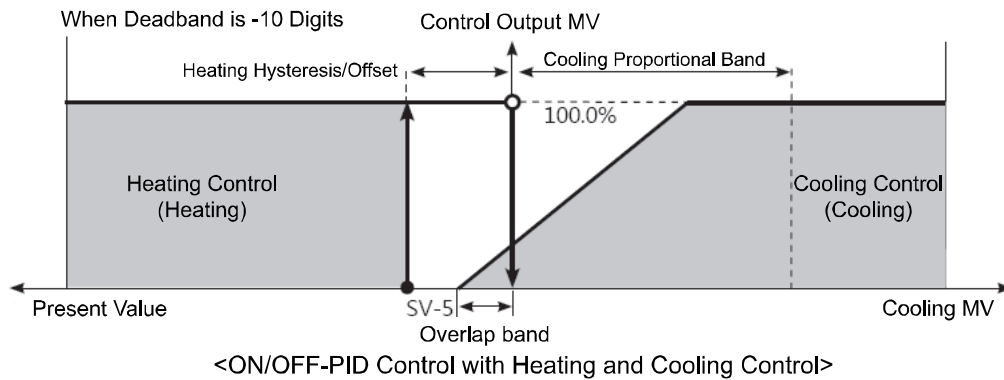
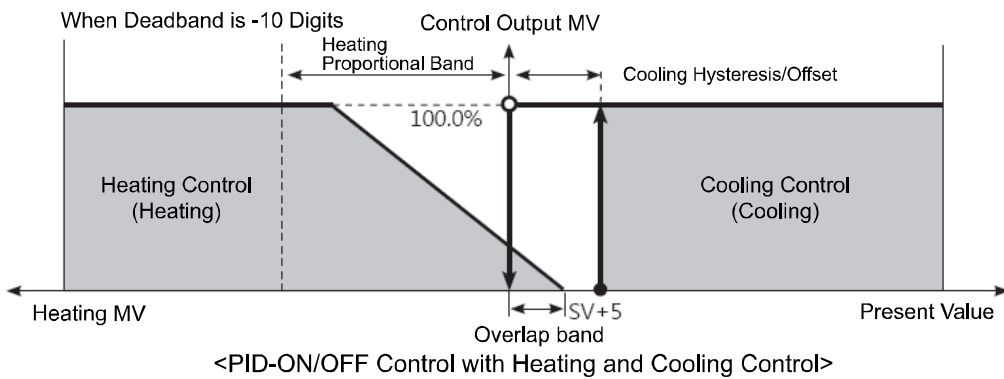
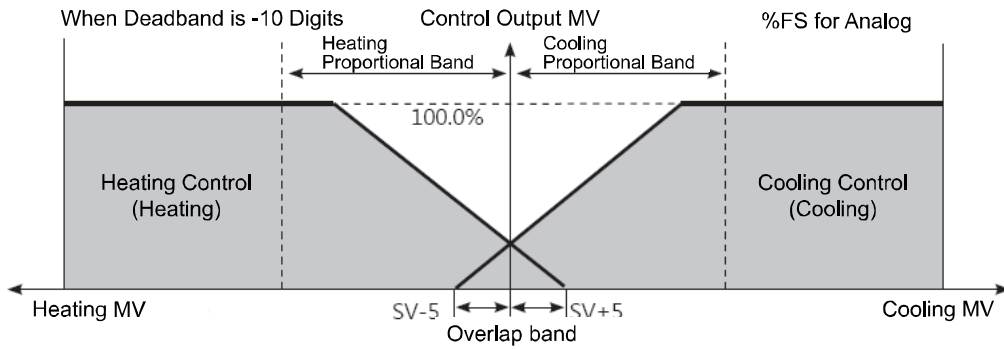

(3) Using neither Deadband nor Overlap Band

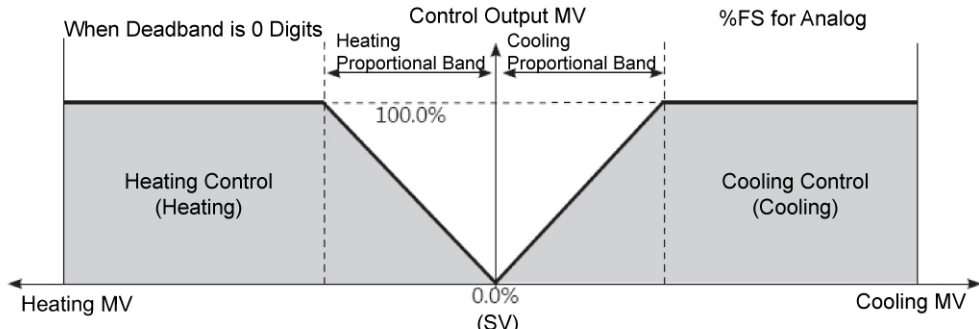

<PID-PID Control with Heating and Cooling Control>

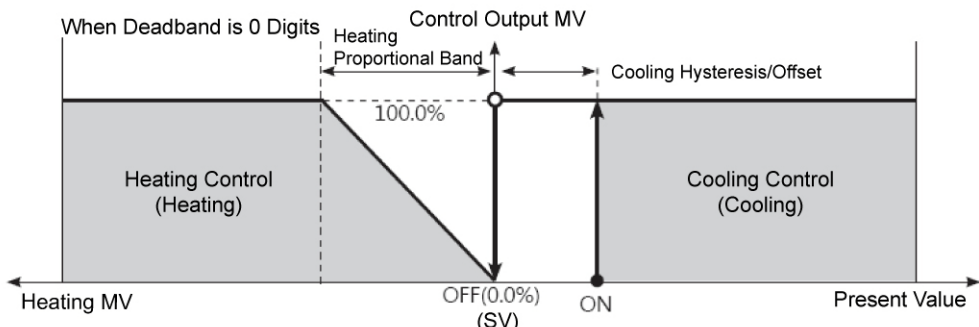

<PID-ON/OFF Control with Heating and Cooling Control>

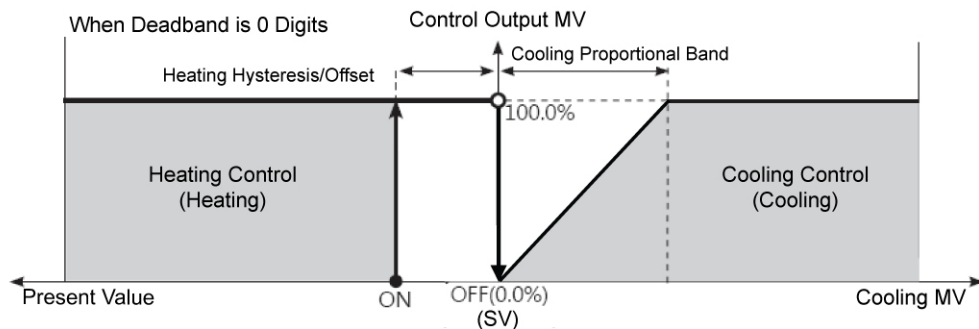

<ON/OFF-PID Control with Heating and Cooling Control>

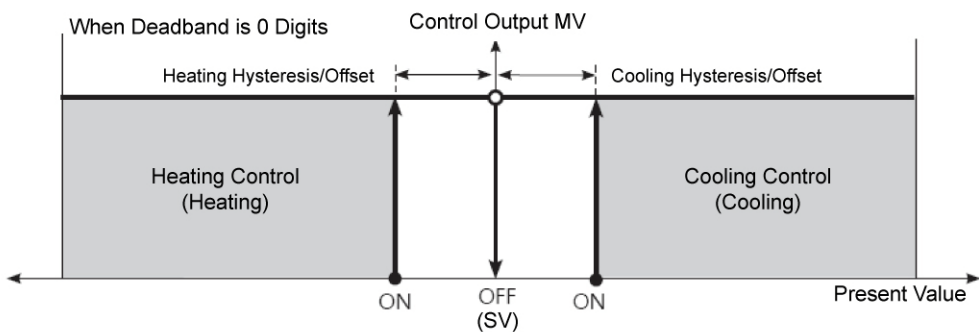

<ON/OFF-ON/OFF Control with Heating and Cooling Control>

6.2.3 MV high/low-limit value

MV high/low-limit values for control output can be configured to the actual MV, provided the temperature controller's MV calculation exceeds the limits.

During heating and cooling control, cooling MV carries a "-" prefix. Therefore, the high-limit is expressed as a + value on the heating side and the lower limit as a - value on the cooling side.

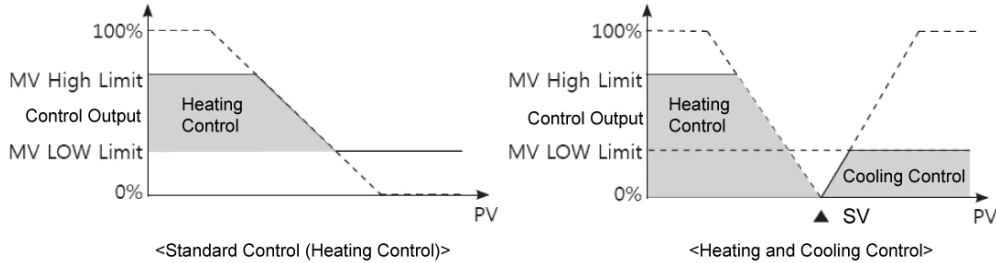

Setting group	Preceding condition	Parameter	Setting range	Factory default	Unit
Control Operation	Heating Cooling	MV Low-limit	0.0 to MV high-limit - 0.1	0.0	%
		MV High-limit	MV low-limit + 0.1 to 100.0	100.0	
	Heating and Cooling	MV Low-limit	-100.0 to 0.0	-100.0	%
		MV High-limit	0.0 to 100.0	100.0	



Note

- Same MV high/low-limit value will be applied during Auto-tuning.
- MV high/low-limit values are not applied to manual control, MV upon control stop, MV upon a sensor error, and initial manual control MV.
- MV high/low-limit value configuration is not available for ON/OFF control in standard control mode (heating or cooling control).

6.2.4 Ramp function

Ramp is a feature used to configure the slope toward SV (setting value). The feature limits change rate of SV and thereby restricts sudden temperature changes (increase and decrease) in the control subject.

Ramp is commonly used in applications where rapid temperature changes (increase and decrease) could impact negatively on the control subject.

Setting group	Parameter	Setting range	Factory default	Unit
Control Operation	Ramp_Up/Down Change Rate	0 (OFF) to 9999	0	-
	Ramp Time Unit	SEC, MIN, HOUR	MIN	-



Note

- For ceramic or pottery furnaces, rapid heating may break the furnace subject. Apply Ramp Up Change Rate to control the temperature.
- Activating the ramp feature when the ramp is not in operation limits the rate of SV (setting value) change based on PV (present value). Changing SV or ramp parameters when the ramp is in operation limits the rate of SV change based on SV at the point of the change.
- SV determines the control of the control subject temperature. The SV changes based on the configured rate of change (hereinafter referred to as RAMP SV).
- Ramp Up change rate and Ramp Down change rate can be set independently.
- Alarm activation with the ramp in operation depends on the final SV.
- Setting the rate of ramp change to 0 deactivates the ramp feature.

(1) Ramp status by modes

Operation status	RAMP rate	Ramp function
All modes.	When 0	Inactive
OPEN, HHHH, LLLL, Auto-tuning, Auto→Manual, RUN→STOP	Irrespective of conditions.	Inactive
OPEN, HHHH, LLLL, after Auto-tuning, PV = SV	Irrespective of conditions.	Inactive
Power On, SV change, switch from STOP to RUN, switch from Manual to Auto, Ramp Rate or Ramp time unit change	When not 0	Active



Ex.

Example Ramp graph

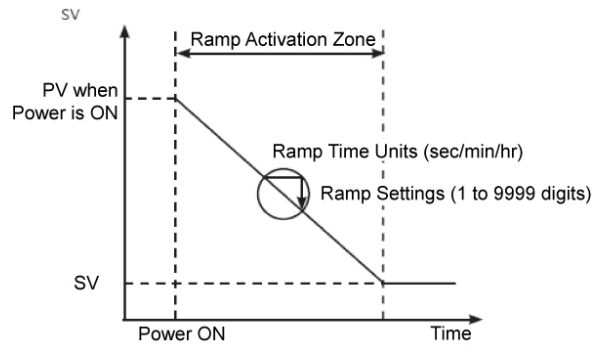
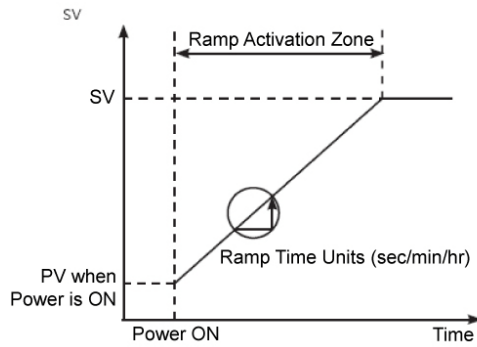

<Initial power on, Ramp value change>

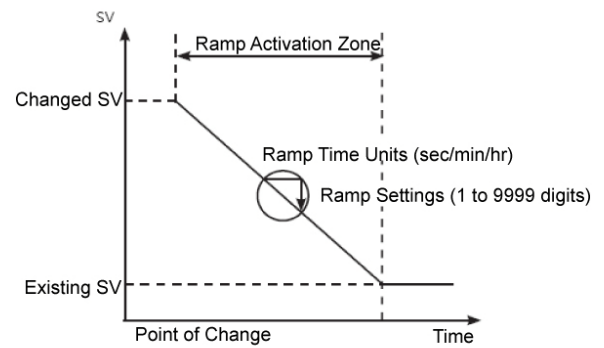
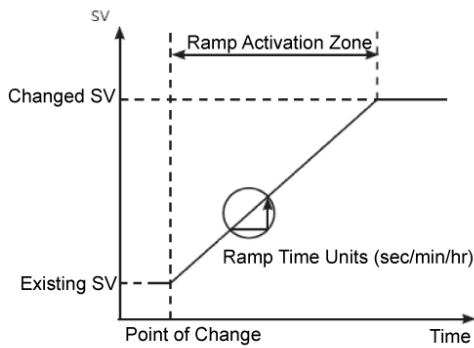

<SV setting change, Change SV setting with multi SV feature>

6.2.5 Auto/Manual control

- Auto control: This mode implements control over MV, which is calculated under PID control and based on SV as the target.
- Manual control: This mode implements control with user-defined MV.

Setting group	Parameter	Setting range	Factory default	Unit
Monitoring	Auto-Manual Control	AUTO, MANUAL	AUTO	-

- Can be used by setting digital input terminal (DI1, DI2) to STOP function.



Note

- Auto/manual control switching is not allowed in ON/OFF control mode.
- When the unit is powered on following a power interruption or shutdown, auto or manual control will be maintained.
- When in operation, AT (Auto-tuning) can be switched to manual control.
- When in Stop mode, manual control can be activated.
- If SBA (Sensor Break Alarm) occurs during standard control, the sensor error MV is applied. In this state, switching to manual mode is possible and manual control MV settings can also be modified.
- When the control unit is in operation, it is possible to switch to manual or auto control mode.
- Priority: Manual control > Stop > Open (sensor break)

6.2.6 Manual control baseline MV

When switching from auto to manual control you can set the initial MV.

- AUTO-MV: When switching modes use auto control MV as the initial manual control.
- PRESET-MV: Apply preset MV as the initial manual MV.

Setting group	Preceding condition	Parameter	Setting range	Factory default	Unit
Control Setting	PID	Initial Manual MV	AUTO-MV: PRESET-MV:	AUTO-MV:	-

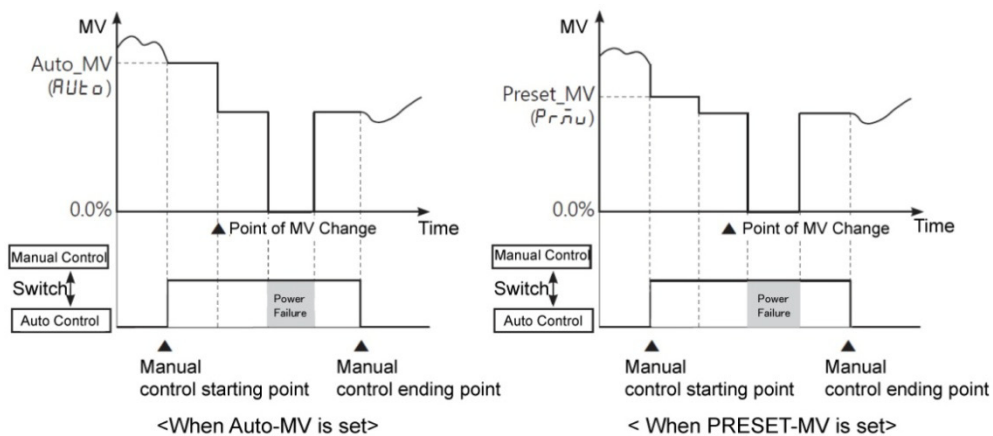

Note

Reverting to power, the control starts with the MV of the power off.

6.2.7 Manual control initial MV

If the baseline MV for manual control is configured to PRESET-MV, you can set the initial MV for manual control.

Setting group	Preceding condition	Parameter	Setting range	Factory default	Unit
Control Setting	Heating, Cooling, PID	Preset Manual MV	0.0 to 100.0	0.0	%
	Heating & Cooling, PID		-100.0 (Cool) to 100.0 (Heat)	0.0	



Note

When in heating and cooling control, a setting between 0.1 and 100.0 applies heating MV, and a setting between 0.1 and -100.0 applies cooling MV.

6.2.8 Control output

If the control output type is a current or SSR drive output model, control output is supported at the same time, so the user can choose a suitable output type.

Setting group	Parameter	Setting range	Factory default	Unit
Initial Setting	Output(SSR_Curr) Type	SSR, CURRENT	SSR	-



Note

The relevant parameter will be activated only if the model is TM2-□□C□ (current or SSR drive output type).

6.2.8.1 Current output range

If the control output is set to current output, you can select high and low-limit range for the current output as either 4-20mA or 0-20mA.

Setting group	Parameter	Setting range	Factory default	Unit
Initial Setting	Current Output Range	0-20, 4-20	4-20	mA



Note

If the model is TM2-□□C□ (current or SSR drive output type), the relevant parameter will be activated only if the control output is set to current.

6.3 Temperature control

6.3.1 Temperature control method

You can choose the type of temperature control method.

Setting group	Preceding condition	Parameter	Setting range	Factory default	Unit
Initial Setting	Heating, Cooling	Control Method	PID, ONOFF	PID	-
	Heating and Cooling		PID-PID PID-ONOFF ONOFF-PID ONOFF-ONOFF	PID-PID	-

6.3.2 ON/OFF control

Controls the temperature by comparing PV(present value) with SV(setting value) and turning power to the load on or off.

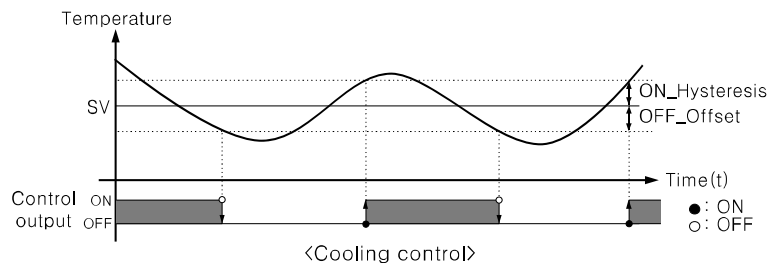
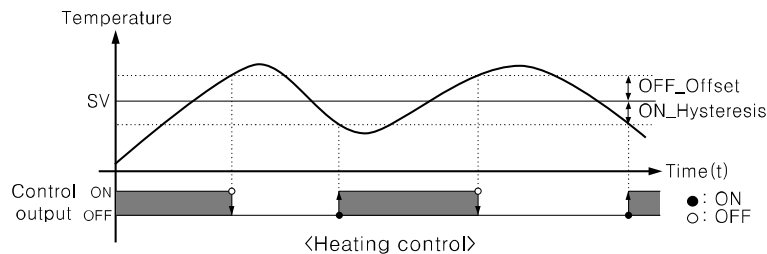

6.3.2.1 Hysteresis

An ON/OFF control feature is used to define the control output ON/OFF points. ON_Hysteresis sets the output on point and OFF_Offset sets the off point.

Setting hysteresis too low can result in hunting induced by disturbance (noise, chattering, etc.). To minimize hunting, set ON_Hysteresis and OFF_Offset values according to the heater or cooler's capacity and thermal characteristics, control subject and sensor response characteristics, installation conditions, and other defining factors.

Setting group	Preceding condition		Parameter	Setting range	Factory default	Unit
Control Operation	Heating & Cooling	Heating	Heating_ON Hysteresis	1 to 100(H) 0.1 to 100.0(L)	2	Digit
			Heating_OFF Offset	0 to 100(H) 0.0 to 100.0(L)	0	
		Cooling	Cooling_ON Hysteresis	1 to 100(H) 0.1 to 100.0(L)	2	
			Cooling_OFF Offset	0 to 100(H) 0.0 to 100.0(L)	0	

6.3.3 PID control

PID control is a combination of proportional (P), integral (I), and derivative (D) controls and offers superb control over control subjects, even with a delay time.

Proportional control (P) implements smooth, hunting-free control; integral control (I) automatically corrects offsets; and derivative control (D) speeds up the response to disturbance. Through these actions, PID control realizes ideal temperature control.

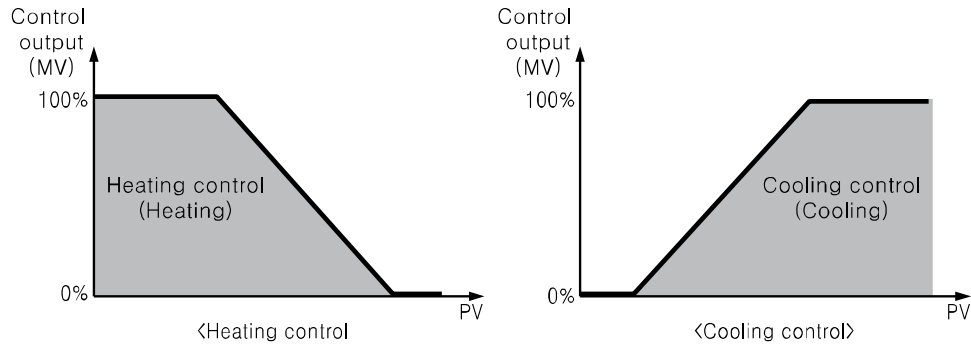

Note

How to apply PID control

- Proportional (P) control: Set both integral and derivative times to 0 after PID control is selected.
- Proportional-Integral (PI) control: Set the derivative time to 0 after PID control is selected.
- Proportional-Derivative (PD) control: Set the integral time to 0 after PID control is selected.
- When using the multi-SV function, the same PID time constant will be applied to SV0 to SV3.

6.3.3.1 Proportional band

When PV (present value) is within the proportional band (P), the ON/OFF ratio needs to be adjusted during the proportional period (T). The defined proportional control (time proportional control) section is referred to as the proportional band.

Setting group	Preceding condition	Parameter	Setting range	Factory default	Unit
Control Operation	Heating, PID	Heating_Proportional Band	0.1 to 999.9	10.0	°C/°F
	Cooling, PID	Cooling_Proportional Band			

6.3.3.2 Integral time

MVs from integral and proportional operation become the same when deviation is consistent. The time taken for the two MVs to match is called the integral time.

Setting group	Preceding condition	Parameter	Setting range	Factory default	Unit
Control Operation	Heating, PID	Heating_Integral Time	0 to 9999	0	Sec.
	Cooling, PID	Cooling_Integral Time			



Note

- Integral control is not conducted if the integral time is set to 0.
- Setting the integral time too short can intensify Correction Movements and cause hunting.

6.3.3.3 Derivative time

In accordance with the deviation of the ramp, the time taken for the MV gained from derivative operation to reach the MV gained from proportional control is called the derivative time.

Setting group	Preceding condition	Parameter	Setting range	Factory default	Unit
Control Operation	Heating, PID	Heating_ Derivation Time	0 to 9999	0	Sec.
	Cooling, PID	Cooling_ Derivation Time			



Note

Derivative control is not conducted if the derivative time is set to 0.

6.3.3.4 Control period

If relay or SSR is used to send out MV under proportional control, the output is on for a fixed amount of time (within the control period, as a percentage of the MV) and then remains off. The preset period when output ON/OFF takes place is called the proportional control period.

Control using SSR drive voltage output has a faster response than that of relay output. Therefore, by configuring a shorter control period, more responsive temperature control is achieved.

Setting group	Preceding condition	Parameter	Setting range	Factory default	Unit
Initial Setting	Heating, PID	Heating_ Control Time	0.1 to 120.0	20.0 (RY)	Sec.
	Cooling, PID	Cooling_ Control Time		2.0 (SSR)	



Note

If using heating and cooling control, configure each control period separately for heating and cooling.

6.3.3.5 Offset correction/Manual reset

When only proportional control (P, PD control) is used, the control subject's thermal capacity and heater capacity affect the heating and cooling time. This means stable control will still experience some deviation called offset. Offset can be corrected using manual reset.

Setting group	Preceding condition	Parameter	Setting range	Factory default	Unit
Control Operation	PID	Manual Reset	0.0 to 100.0	50.0	%



Note

- Manual reset adjustment based on control results

Under stable control conditions, set the offset to 50% if PV and SV are identical, to over 50.0% if PV is lower than SV, and below 50.0% if PV is higher than SV.

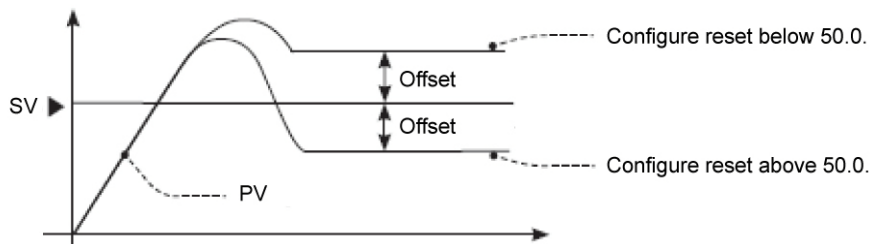

- The offset correction feature can only be used when proportional control is in effect. Setting the integral value to 0 makes the manual reset parameter visible.
- The user cannot configure the manual reset setting during heating and cooling control. Instead, the setting is automatically set to 0% for both heating and cooling.
- Applicable only when integral time is set to 0 (under P control or PD control only).
- Switching from heating and cooling control to standard control (P, PD control) automatically configures the reset setting to 50%.

6.3.4 Auto-tuning

In PID control, auto-tuning processes the control subject's thermal characteristics and thermal response rate, and then determines the necessary PID time constant. Application of the PID time constant realizes fast response and high precision temperature control.

6.3.4.1 Auto-tuning ON/OFF

- Auto-tuning automatically stores PID time constants upon termination. These PID time constants can then be modified by the user to suit their usage environment.
- When performing auto-tuning, the output LED of the pertinent channel flashes at 1 second intervals. Once auto-tuning is complete, the output LED automatically goes off, and the parameter value returns from ON to OFF.

Setting group	Preceding condition	Parameter	Setting range	Factory default	Unit
Control Operation	PID	Auto-Tuning Execute	OFF, ON	OFF	-



Note

- If manual control is selected during auto-tuning, auto-tuning operation will be closed.
- If sensor break error occurs during auto-tuning, the sensor is automatically closed and the previous PID time constant kept.
- Auto-tuning continues to run even if the temperature reading exceeds or falls below the input range.
- When auto-tuning is in progress, parameters can only be referenced and not altered.
- When auto-tuning is in progress and digital input(DI-1,DI-2) feature is run/stop or auto/manual, auto-tuning will be automatically ended, if concerned DI is inputted or sensor break error occurs.
- Auto-tuning is not available in manual control.

6.3.4.2 Auto-tuning mode

Auto-tuning is available in Tun1 MODE (SV) or Tun2 MODE (70% of SV), depending on the baseline value used.

- Tun1 Mode [TUN1]: Auto-tunes and calculates a PID time constant based on SV.
- Tun2 Mode [TUN2]: Auto-tunes and calculates a PID time constant based on 70% of SV.

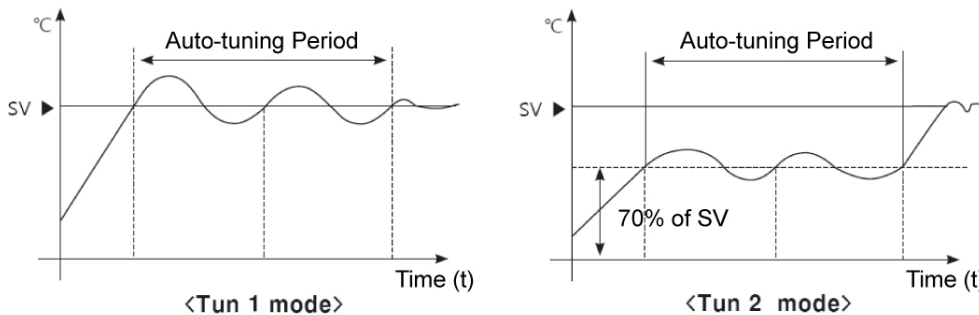

Setting group	Preceding condition	Parameter	Setting range	Factory default	Unit
Initial Setting	PID	Auto-Tuning Mode	TUN1 TUN 2	TUN 1	-



Note

In cooling control mode, TUN2 Mode calculates 70% based at 0°.

E.g.) If SV is -100, executes TUN2 at -70.

6.4 Alarm output

Alarm output is a relay output that activates irrespective of control output. Alarm output works when the temperature of the controlled subject exceeds or falls below the preset temperature range.

Alarm temperature setting values consist of absolute temperatures or offset temperatures, depending on the alarm output mode.



Note

Alarm output function is only for TM2 Series.

6.4.1 Alarm output target channel

Users can set channels in which alarm output (2 or 4) will be activated.

Setting group	Parameter	Setting range	Factory default	Unit
Alarm Setting	Alarm Target Ch	CH1, CH2, CH1 and CH2, CH1 or CH2	Alarm 1, 3: CH1 Alarm 2, 4: CH2	-



Note

In case of heating/cooling control, Alarm 1 and Alarm 2 are used as a cooling control output; therefore, they cannot be used as an alarm output.

6.4.2 Alarm output operating mode

Select the desired alarm output mode.

Mode	Alarm Output	Description (Factory default)
OFF	_____	No alarm output
AL-1		Deviation high-limit alarm (+F.S.) If PV/SV deviation occurs higher than set value of deviation temperature, alarm output will be ON. High limit deviation temperature can be set in AL1.H/AL2.H/AL3.H/AL4.H.
AL-2		Deviation low-limit alarm (+F.S.) If PV/SV deviation occurs lower than set value of deviation temperature, alarm output will be ON. Low-limit deviation can be set in AL1.H/AL2.H/AL3.H/AL4.H.
AL-3		Deviation high/low-limit alarm (+F.S.) If PV/SV deviation occurs higher than high-limit deviation or lower than low-limit deviation, alarm output will be ON. High-limit deviation can be set in AL1.H/AL2.H/AL3.H/AL4.H. Low-limit deviation can be set in AL1.H/AL2.H/AL3.H/AL4.H.
AL-4		Deviation high/low-limit reverse alarm If PV/SV deviation occurs higher than low-limit deviation or lower than high-limit deviation, alarm output will be ON. High-limit deviation can be set in AL1.H/AL2.H/AL3.H/AL4.H. Low-limit deviation can be set in AL1.H/AL2.H/AL3.H/AL4.H.
AL-5		Absolute value high-limit alarm If PV is higher than the absolute value of temperature, alarm output will be ON. Alarm absolute value can be set in AL1.H/AL2.H/AL3.H/AL4.H.
AL-6		Absolute value low-limit alarm If PV is lower than the absolute value of temperature, alarm output will be ON. Alarm absolute value can be set in AL1.L/AL2.L/AL3.L/AL4.L.
LBA	On if loop break is detected.	Loop break alarm
SBA	On if sensor break is detected.	Sensor break alarm
HBA	On if current transformer (CT) detects heater break.	Heater burnout alarm

Setting group	Parameter	Setting range	Factory default	Unit
Alarm Setting	Alarm Mode	Refer to the above table.	Alarm 1, 3: AL-1 Alarm 2, 4: AL-2	-

6.4.3 Alarm output option

Select the desired alarm output option mode.

Setting	Mode	Description
AL-A	Standard alarm	If it is an alarm condition, alarm output is ON. Unless an alarm condition, alarm output is OFF.
AL-B	Alarm latch ^{*1}	If it is an alarm condition, alarm output is ON. Before reset the alarm, an ON condition is latched. (Holding the alarm output)
AL-C	Standby sequence 1 ^{*2}	When power is supplied and it is an alarm condition, alarm output does not act. From the second alarm conditions, standard alarm acts.
AL-D	Alarm latch and standby sequence 1	When power is supplied and it is an alarm condition, alarm output does not act. From the second alarm conditions, alarm latch acts.
AL-E	Standby sequence 2	When Standby sequence ^{*3} and it is an alarm condition, alarm output does not act. After deactivate the alarm condition, standard alarm acts.
AL-F	Alarm latch and standby sequence 2	When Standby sequence ^{*3} is repeated and it is an alarm condition, alarm output does not act. After deactivate the alarm condition, alarm latch acts.

※1. Alarm Latch: Deactivating Alarm Output in Alarm Latch mode: Turn off the power or send alarm reset signal.

※2. Standby sequence: This option is applied only if PV is in alarm output ON conditions when power is supplied. If not, alarm output will be provided from the first alarm condition same as other alarm operations.

※3. Conditions of repeated Standby sequence: Power ON, Changing SV, Related Alarm(operation mode, option, setting value), Changing Parameter, Changing STOP mode to RUN mode.

Setting group	Parameter	Setting range	Factory default	Unit
Alarm Setting	Alarm Type	Refer to the above table.	AL-A	-



Note

- You can set alarm output (Alarm 1 Type to Alarm 4 Type) individually.
- If alarm output mode has been selected as LBA, SBA or HBA, AL-C, AL-D modes are not available.



Ex.

Example of SV: 100°C, alarm output operation mode: AL-3(Deviation high/low-limit alarm),
alarm option: AL-E(Standby sequence 2),
(deviation high/low-limit temperature: 10°C, alarm output hysteresis: 5°C)

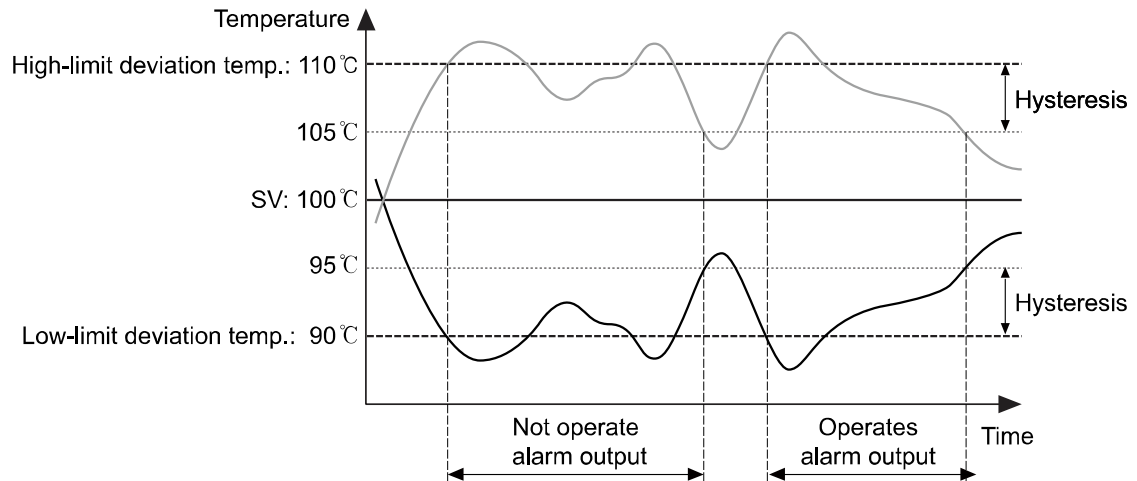

When first alarm condition occurs, alarm output does not operate. From the second alarm condition, alarm output operates.

6.4.4 Alarm SV

You can set alarm output activation values. According to the selected alarm output mode, configuration parameters (AL□.H/AL□.L) will be activated for each setting.

Setting group	Parameter	Setting range	Factory default	Unit
Alarm Setting	Alarm High_Ch Alarm Low_Ch	Deviation alarm: F.S. to F.S. Absolute value alarm: Within the temperature range of input type	1550	°C/°F



Note

Changing the alarm output mode or options resets the settings to the highest or lowest values that will not trigger output in the new mode.

6.4.5 Alarm output hysteresis

“H” shown in the image from ‘6.4.2 Alarm output operating mode’ represents the alarm output hysteresis. It is used to set an interval between alarm output ON/OFF periods.

If PV is over or below alarm output SV, output turns ON and it sets OFF time by hysteresis settings.

When input value is changed near SV, alarm output is often. Set hysteresis and it can be prevented from often alarm output.

Can be set individually by alarm output (Alarm 1 Type to Alarm 2 Type).

Setting group	Parameter	Setting range	Factory default	Unit
Alarm Setting	Alarm Hysteresis_Ch	1 to 100 (H), 0.1 to 100.0 (L)	1	Digit



Note

- Alarm output hysteresis applies to heater burnout alarm (HBA) in the same manner.
- This parameter does not appear if Loop Break Alarm (LBA) or Sensor Break Alarm (SBA) is selected.

6.4.6 Alarm output method

Relay type can be set at alarm output.

- N.O. (Normally Open) stays open when normal and closes in the event of an alarm.
- N.C. (Normally Closed) stays closed when normal and opens in the event of an alarm.

Setting group	Parameter	Setting range	Factory default	Unit
Alarm Setting	Alarm NO/NC	NO, NC	NO	-



Note

Front indicators

Change	Alarm occurs	Alarm output	Indicator
N.O.	OFF	Open	<input type="checkbox"/> OFF
	ON	Close	<input checked="" type="checkbox"/> ON
N.C.	OFF	Close	<input type="checkbox"/> OFF
	ON	Open	<input checked="" type="checkbox"/> ON

6.4.7 Alarm output delay

Alarm output delay can be set to prevent false alarms caused by erroneous input signals resulting from disturbances or noise.

With a preset delay time, alarm output does not turn on for the preset duration. Instead, the concerned alarm indicator on the front will flash in 0.5-second intervals.

- Alarm ON delay time: Stands by for the preset duration upon an alarm event, checks the alarm trigger conditions, and turns on the alarm output if the conditions are still present.
- Alarm OFF delay time: Stands by for the preset duration following alarm output off, checks the alarm trigger conditions, and turns off the alarm output if the deactivation conditions are still present.

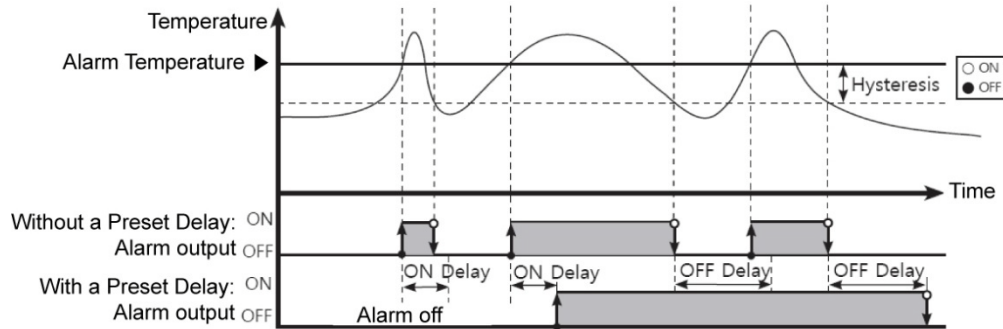

Setting group	Parameter	Setting range	Factory default	Unit
Alarm Setting	Alarm ON Delay Time	0 to 3600	0	Sec.
	Alarm OFF Delay	0 to 3600	0	Sec.

6.4.8 Loop break alarm(LBA)

Diagnoses the control loop by monitoring the control subject's temperature changes and sends out alarms if necessary.

- Heating control: When control output MV is 100% or high limit (MV high limit) and PV is not increased over than LBA detection band (LBA Band) during LBA monitoring time (LBA Time), or when control output MV is 0% or low limit (MV low limit) and PV is not decreased below than LBA detection band (LBA Band) during LBA monitoring time (LBA Time), alarm output turns ON.
- Cooling control: When control output MV is 0% or low limit (MV low limit) and PV is not increased over than LBA detection band (LBA Band) during LBA monitoring time (LBA Time), or when control output MV is 100% or high limit (MV high limit) and PV is not decreased below than LBA detection band (LBA Band) during LBA monitoring time (LBA Time), alarm output turns ON.

Common causes of LBA output ON

- Sensor error (disconnection, short)
- External controller error (magnet, auxiliary relay, etc.)
- External load error (heater, cooler, etc.)
- Misconnections and disconnections of external network.

If it is not as sensor break/HHHH/LLLL, during auto-tuning/manual control/control STOP/ramp function operation, loop break alarm does not operate.

Type	LBA monitoring time	Alarm output	
		Standard alarm	Alarm latch
Initializing Alarm, changing control output operation mode, setting LBA monitoring time/band as 0	Initialize	OFF	OFF
Changing input correction value, set value		Maintains the present alarm	Maintains the present alarm
Changing MV, stopping control, running auto-tuning		OFF	Maintains the present alarm
Occurring sensor break alarm, HHHH, LLLL		ON	ON



Note

Set alarm output operation mode (Alarm Mode) as loop break alarm (LBA) and you can use loop break alarm.

When executing auto-tuning, LBA detection band (LBA Band) and LBA monitoring time(LBA Time) is automatically set based on auto-tuning value.

In case of AT (auto-tuning)/manual control/stop control, loop break alarm (LBA) does not operate. When alarm reset is input, it initializes LBA monitoring start time.

6.4.8.1 LBA monitoring time

You can set the LBA monitoring time to check changes in the control subject's temperature. Automatically setting with auto-tuning.

- Regardless of alarm output operation mode (Alarm Mode) (including LBA monitoring time as "0"), after running auto-tuning, the integration time×2 value is saved automatically. (If SV is out of the range of auto setting, it is set as max. or min. value of auto setting.)
- Except input type changing, re-running auto-tuning, manual setting of LBA monitoring time, it maintains the present SV.
- Auto setting range: 0020 to 9999

Setting group	Parameter	Setting range	Factory default	Unit
Alarm Setting	LBA Time Ch1, LBA Time Ch2	0000 to 9999	0	Sec

6.4.8.2 LBA detection band

You can set the minimum value of deviation change to decrease during LBA monitoring time. Automatically setting with auto-tuning.

- Regardless of alarm output operation mode (Alarm Mode) (including LBA monitoring time as "0"), after running auto-tuning, the integration time×2 value is saved automatically.
- Except input type changing, re-running auto-tuning, manual setting of LBA monitoring time, it maintains the present SV. (If SV is out of the range of auto setting, it is set as max. or min. value of auto setting.)
- Auto setting range
Temperature L: 002.0 to 100.0 (°C/°F)
Temperature H: 0002 to 010.0 (°C/°F)

Setting group	Parameter	Setting range	Factory default	Unit
Alarm Setting	LBA Band Ch1, LBA Band Ch2	0 to 999 (H) 0.0 to 999.9 (L)	2	°C/°F



Ex.

It checks control loop and outputs alarm by temperature change of the subject.

For heating control(cooling control), when control output MV is 100%(0% for cooling control) and PV is not increased over than LBA detection band (LBA Band) during LBA monitoring time (LBA Time), or when control output MV is 0%(100% for cooling control) and PV is not decreased below than LBA detection band (LBA Band) during LBA monitoring time (LBA Time), alarm output turns ON.

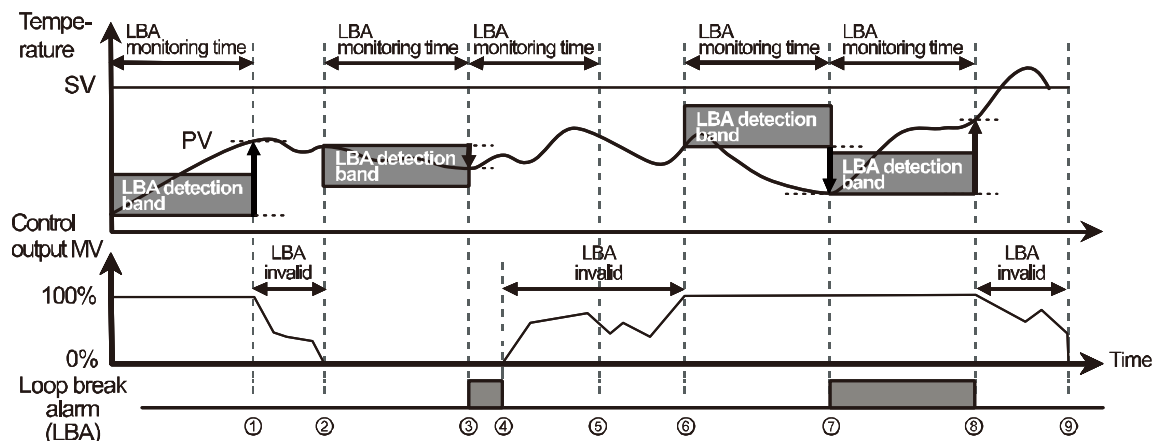

Start to ①	When control output MV is 100%, PV is increased over than LBA detection band (LBA Band) during LBA monitoring time (LBA Time).
① to ②	The status of changing control output MV (LBA monitoring time is reset.)
② to ③	When control output MV is 0% and PV is not decreased below than LBA detection band (LBA Band) during LBA monitoring time (LBA Time), loop break alarm (LBA) turns ON after LBA monitoring time (LBA Time).
③ to ④	Control output MV is 0% and loop break alarm (LBA) turns and maintains ON.
④ to ⑥	The status of changing control output MV (LBA monitoring time is reset.)
⑥ to ⑦	When control output MV is 100% and PV is not increased over than LBA detection band (LBA Band) during LBA monitoring time (LBA Time), loop break alarm (LBA) turns ON after LBA monitoring time (LBA Time).
⑦ to ⑧	When control output MV is 100% and PV is increased over than LBA detection band (LBA Band) during LBA monitoring time (LBA Time), loop break alarm (LBA) turns OFF after LBA monitoring time (LBA Time).
⑧ to ⑨	The status of changing control output MV (LBA monitoring time is reset.)

6.4.9 Sensor break alarm

You can set the controller to send out an alarm when a sensor is not connected or disconnected during temperature control. Sensor break can be confirmed through an external alarm output contact, such as a buzzer or similar means.

Setting alarm output mode (alarm mode) to SBA will activate sensor break alarm.



Note

Alarm output option can be set to standard alarm (AL-A) or alarm latch (AL-B).

6.4.10 Heater disconnection alarm

When using a heater to raise the temperature of the control subject, the temperature controller can be set to detect heater disconnection and send out an alarm by monitoring power supply to the heater.

Heater disconnection is detected by the controller using a current transformer (CT), which converts the current to the heater to a specific ratio (CT ratio) for monitoring. If the heater current value (CT-A) measured by the CT is less than the heater detection setting value (Alarm Low_CH), the heater burnout alarm will activate.

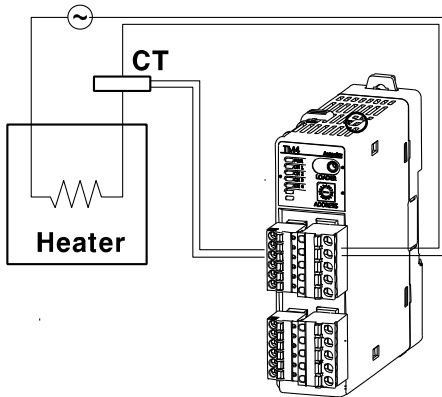

Note

- Heater burnout detection only takes place when the temperature controller's output is turned on. Otherwise, heater burnout will not be detected by the controller.
- Detection is only available in models with switching output (relay, SSR drive output).
- Current detection is not performed if OUT control output time is less than 250 ms.
- It is recommended to use Autonics designated current transformer (for 50 A).
- Alarm output option can be set to standard alarm (AL-A) or alarm latch (AL-B).

6.4.10.1 Heater disconnection detection SV

Set the alarm output value (Alarm Low_Ch) as the reference value for heater burnout detection.

Setting group	Parameter	Setting range	Factory default	Unit
Alarm Setting	Alarm Low_Ch	0.0 to 50.0	0.0	A



Note

Set to 00.0 for OFF. Set to 50.0 for ON.

Setting value calculation

: Heater burnout setting value = {(normal heater current values) + (heater burnout current)}/2



Ex.

- If using a single output heater (Capacity: 200 VAC, 1 KW, 5 A), normal heater current is 5 A, and burnout heater current is 0 A, the setting value is calculated as $(5\text{ A} + 0\text{ A})/2 = 2.5\text{ A}$. Therefore, heater current values less than 2.5 A (heater burnout setting value) will be deemed heater burnout and the alarm will activate.

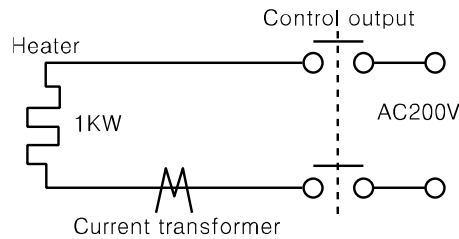

- When two output heaters (Capacity: 200 VAC, 1 KW, 5 A) are used, normal heater current is 10 A ($5\text{ A} \times 2$). If a single heater burns out, the heater current becomes 5A. The setting value is calculated as $(10\text{ A} + 5\text{ A})/2 = 7.5\text{ A}$. Heater current values of less than 7.5 A (heater burnout setting value) are deemed heater burnout and the alarm activates.

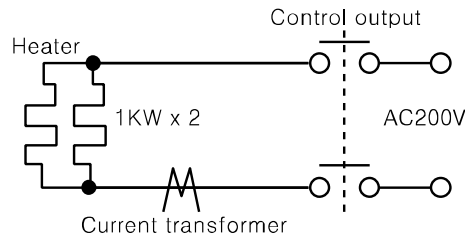

6.4.11 Alarm output OFF

Available only if alarm output option is set to alarm latch or alarm latch and standby sequence1, alarm latch and standby sequence2. It can be set to turn off alarm output when alarm output is on, alarm output conditions have been removed, or an alarm output off signal that is greater than the minimal signal band is received. (However, alarm output off is unavailable when alarm conditions remain in effect.)

You can assign the digital input terminals (DI-1, DI-2) for the alarm output off feature.



Note

- For more information about digital terminal (DI) setting, please refer to '6.9.1 Digital input terminal'.
- After deactivating the alarm output, it will function normally for the next alarm output occurrence.

6.4.12 Alarm output examples

(1) Absolute value high-limit alarm and deviation high-limit alarm

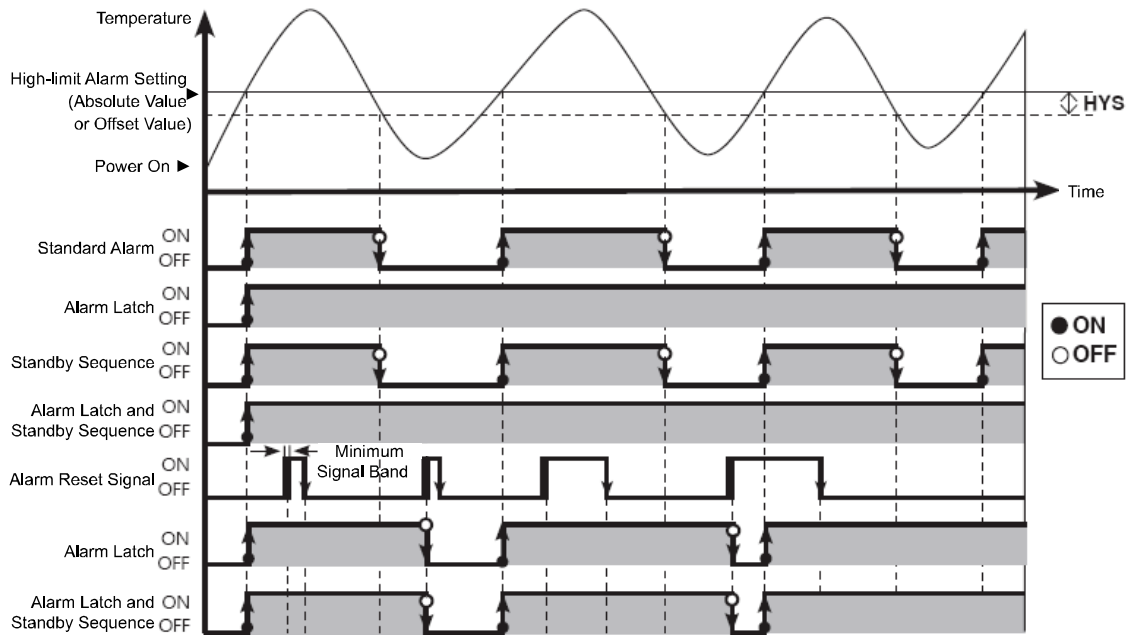

※HYS: Hysteresis

(2) Absolute value low-limit alarm and deviation low-limit alarm

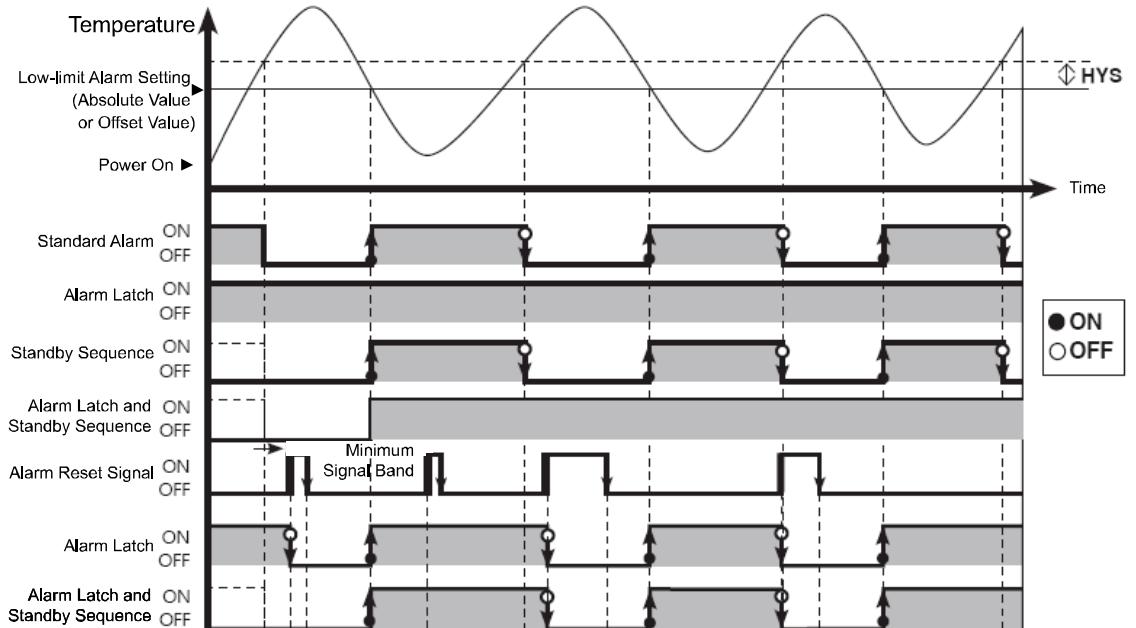

※HYS: Hysteresis

(3) Deviation high/low-limit alarm

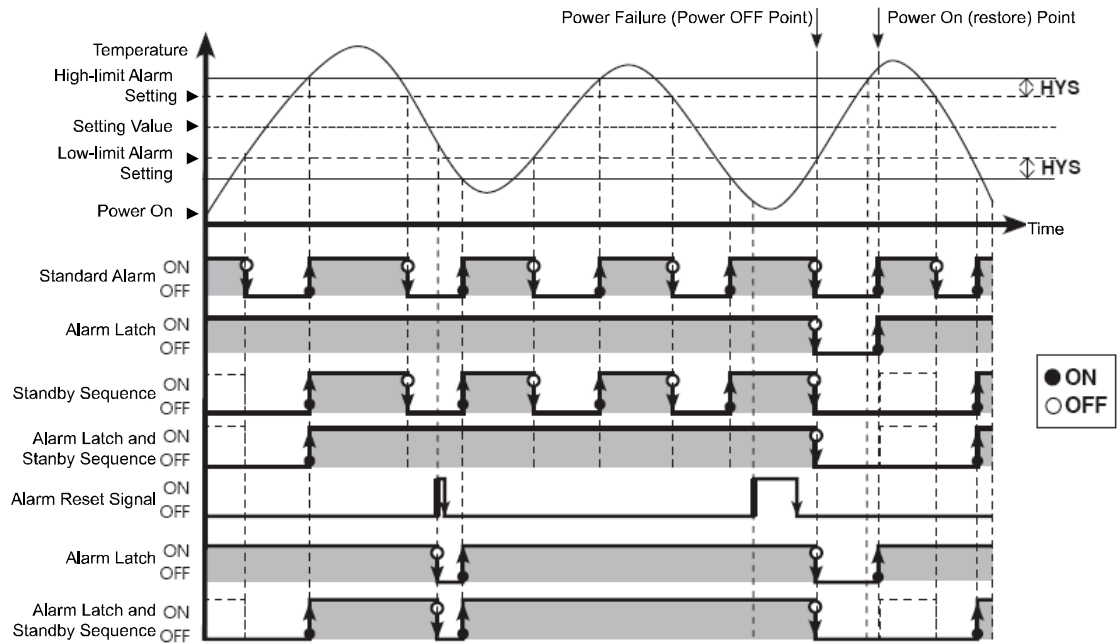

※HYS: Hysteresis

(4) Deviation high/low-limit reverse alarm

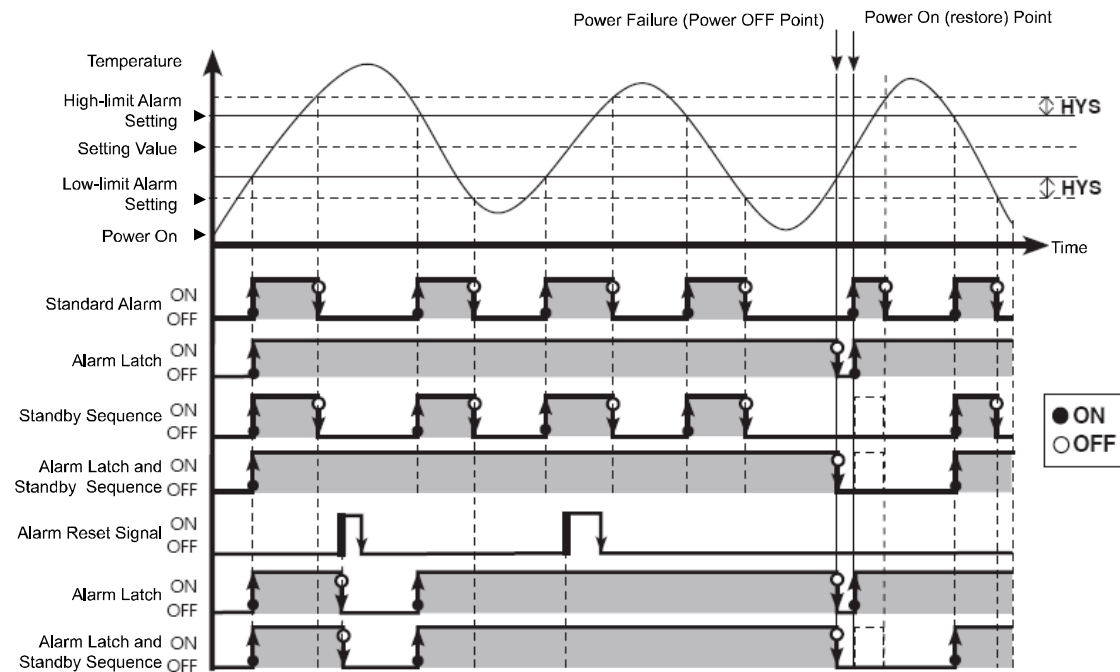

※HYS: Hysteresis

(5) Deviation high/low-limit alarm (hysteresis overlap)

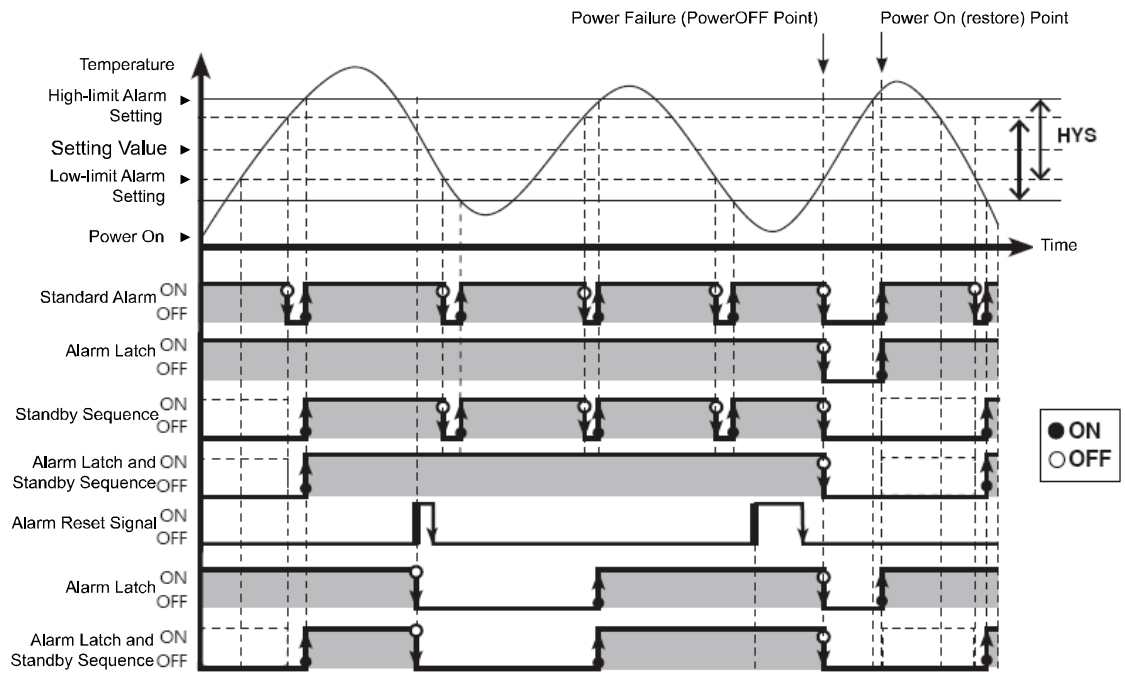

※HYS: Hysteresis

6.5 Communications

This feature is used for external higher systems (PC, GP, etc.) to set the controller's parameters and to monitor the controller. It can also be used to external devices.

- No redundant unit addresses may exist along the same communication line.
- The communication cable must be twisted pair that supports RS485.

(1) Interface



Comm. protocol	Modbus RTU
Connection type	RS485
Application standard	Compliance with EIA RS485
Max. connection	31 units (address: 01 to 31)
Synchronous method	Asynchronous
Comm. method	Two-wire half duplex
Comm. method	Max. 800m
Comm. speed	2400, 4800, 9600(default), 19200, 38400
Start bit	1-bit (fixed)
Data bit	8-bit (fixed)
Parity bit	None(default), Even, Odd
Stop bit	1-bit, 2-bit (default)

6.5.1 Communication address

You can assign a unique address to each device.

Users can set communication address using both SW1 (communication address setting switch) and SW2 (communication group change switch).

- Setting range: 01 to 31
- Factory default: [SW1] 1, [SW2] +0

SW1																
SW2	0	1	2	3	4	5	6	7	8	9	A	B	C	D	E	F
 +0 +16	00	01	02	03	04	05	06	07	08	09	10	11	12	13	14	15
 +0 +16	16	17	18	19	20	21	22	23	24	25	26	27	28	29	30	31



Note







If 00 is designated, communications are not performed.

6.5.2 Communications speed settings

You can set the rate of data transmission.

Setting group	Parameter	Setting range	Factory default	Unit
Communication Setting	Baudrate	2400, 4800, 9600, 19200, 38400	9600	bps

- A display LED corresponding to the current bps flashes for 5 seconds (1 second intervals) when the power supply is initially ON.

Indicator	TM2 Series	TM4 Series	BPS (Bits Per Second)
	PWR	PWR	-
	CH1	CH1	2400
	CH2	CH2	4800
	AL1	CH3	9600
	AL2	CH4	19200
	AL3	-	38400
	AL4	-	-



Note

- It is required to reset controller's POWER (Power OFF -> Power ON) after changing communication speed (bps) via Power/Comm. connection terminal.
- One module communication is allowed for PC loader port. Communication speed is fixed to 9600 bps.
- Make sure that each module has its own communication address. If there are overlapping addresses, parameters for overlapping module cannot be monitored and it may affect the whole communication speed.

6.5.3 Communications parity bit

Parity bit is a data communication method that adds an additional bit to each character in transmitted data as an indicator used to verify data loss and corruption. This parameter is used to enable or disable the parity bit option.

SV (setting value)	Description
NONE	Disables parity bit.
EVEN	Sets the total bits with signal value of 1 as even numbers.
ODD	Sets the total bits with signal value of 1 as odd numbers.

Setting group	Parameter	Setting range	Factory default	Unit
Communication Setting	Parity Bit	NONE, EVEN, ODD	NONE	-

6.5.4 Communication stop bit

You can set the number of bits to mark the end of a transmitted data string.

Setting value	Description
1	Sets end of data string to 1 bit.
2	Sets end of data string to 2 bit.

Setting group	Parameter	Setting range	Factory default	Unit
Communication Setting	Stop Bit	1, 2	2	-

6.5.5 Response wait time

Set a standby time to mitigate communication errors when communicating with a slow master device (PC, PLC, etc.). Once a standby time is set, the controller will respond after the defined standby time has elapsed.

Setting group	Parameter	Setting range	Factory default	Unit
Communication Setting	Response Wait Time	5 to 99	20	ms



Note

Shorter standby times can cause communication errors in the master device.

6.5.6 Enable/Disable communications writing

This feature can change parameter settings stored in memory through communication with PC, GP, PLC, etc., in order to permit or prohibit writing.

Setting value	Description
ENABLE	Parameter set/change enable via communication.
DISABLE	Prohibit parameter setting or modification via communication.

Setting group	Parameter	Setting range	Factory default	Unit
Communication Setting	Communication Write	ENABLE, DISABLE	ENABLE	-



Note

Reading parameter settings is always permitted.

6.5.7 USB-to-Serial connection

Data can be transmitted via a USB-to-serial connection. However, RS485 communication through a USB-to-serial connection is blocked by hardware.

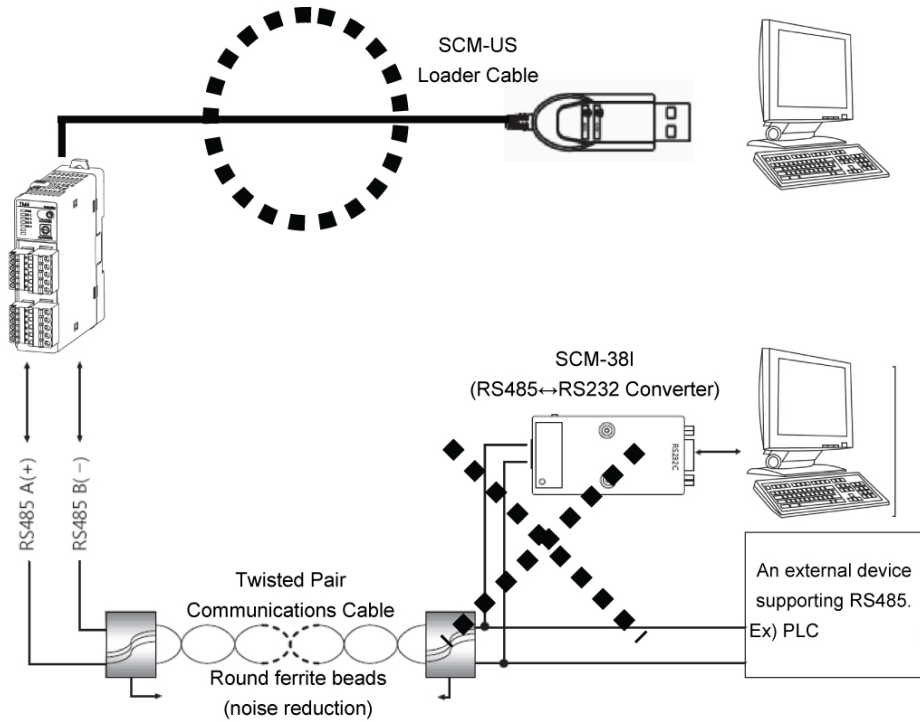

6.6 Monitoring function

6.6.1 Control output MV monitoring

Monitors and displays the current control output MV.

6.6.2 Heating MV monitoring

Displays the current heating MV during heating control or heating and cooling control. Users may manually adjust the MV to control the temperature.

- Measurement range: 0.0 to 100.0%

6.6.3 Cooling MV monitoring

Displays the current cooling MV during cooling control or heating and cooling control. Users may manually adjust the MV to control the temperature.

- Measurement range: 0.0 to 100.0%

6.6.4 Heater current monitoring

A feature that monitors and displays the current of a heater (load) being controlled by control output.

- Measurement range: 0.0 to 50.0A



Note

The current value of a heater (load) is measured and displayed through the current transformer.

Setting group	Parameter	Setting range	Factory default	Unit
Monitoring	Heating_MV	0.0 to 100.0	-	%
Monitoring	Cooling_MV	0.0 to 100.0	-	%
Monitoring	CT1_Heater Current	0.0 to 50.0	-	A
Monitoring	CT2_Heater Current	0.0 to 50.0	-	A

6.7 Run/Stop function

Users may run or stop control output by force while in Run mode.

The STOP command stops the control output. Alarm output, other than control output, maintains the values as set in the alarm output setting at the point of STOP.

This feature can be enabled by configuring parameters. The digital input terminals (DI-1 and DI-2) can be assigned to the run/stop feature.



Note

- Modifications on RUN/STOP are allowed even when in open state. The STOP status will remain in effect after shutting down the controller and powering it back on.
- When STOP is in effect, MV based on the control output at the point of STOP (Stop.MV) is displayed, and continues to be displayed even if a sensor break occurs.
- When restarting after STOP, the initial MV is the MV at the end point.
- The run/stop setting remains in effect after turning power back on.

6.7.1 Control output for STOP

This sets the control output value upon a STOP. With ON/OFF control, select between 0.0 (OFF) and 100.0 (ON). In PID control, you can directly choose MV within a range of 0.0 to 100.0.

Setting group	Preceding condition		Parameter	Setting range	Factory default	Unit
Control Setting	Heating, Cooling	PID	Stop MV	0.0 to 100.0	0.0	%
		ON/OFF		0.0 (OFF)/100.0 (ON)		
	Heating & Cooling	PID		-100.0 (Cool) to 100.0 (Heat)	0.0	
		ON/OFF		-100.0 (Cool ON) /0.0 (OFF) /100.0 (Heat ON)		



Note

When set to STOP, the preset MV is used for output ignoring the MVs from ON/OFF control and PID control.

6.7.2 Alarm output for STOP

Enable or disable alarm output upon a stop.

- CONTINUE: Alarm output operates normally.
- OFF Alarm output ceases along with a stop under all conditions. (However, reverting to Run mode after a stop in alarm latch or alarm latch and standby sequence restores the alarm output to the previous state.)

Setting group	Parameter	Setting range	Factory default	Unit
Control Setting	Stop Alarm Out	CONTINUE, OFF	CONTINUE	-

6.8 Multi SV

Multi SV function allows users to set multiple SVs and save each setting in SV0 to SV3. User can change Multi SV number or select desired SV using external DI (Digital Input, DI-1, DI-2) terminal.

This feature supports up to four SVs which can be independently configurable.

6.8.1 Number of multi SVs

You can set the number of Multi SVs. Select the number of Multi SVs from the controlled subject.

Number of SVs	SV Setting
1	SV-0
2	SV-0, SV-1
4	SV-0, SV-1, SV-2, SV-3,

6.8.2 Multi SV No. settings

You can select the SV to desired control.



Note

The SV No. selection range varies according to the number of multi SVs.

6.8.3 SV for Multi SVs

Designate the value of each SV for Multi SVs.

Setting group	Preceding condition	Parameter	Setting range	Factory default	Unit
Control Setting	-	Multi SV	1EA, 2EA, 4EA	1EA	Numbers
Control Operation	Multi SV	Multi SV No.	SV-0 to SV-3	SV-0	-
Control Operation	Multi SV	SV-0 to SV-3	SV Low-limit to SV High-limit	0	°C, °F

6.9 Digital input

6.9.1 Digital input terminal settings

When send the signal to the external digital input (DI-1, DI-2) terminal, the settings of the digital input □_Func parameter will perform. When powers on, it will activate after checking the digital input terminal.

Setting value	Description
OFF	No function.
STOP	If DI-1,DI-2 terminals are shorted, the stop feature will perform, but to change run/stop through communication will not perform.
AL-RESET	If DI-1,DI-2 terminals are shorted, the forced deactivation of alarm output will perform, but to deactivate the alarm output through communication will not perform.
Manual	If DI-1,DI-2 terminals are shorted, the manual control feature will perform, but to change auto/manual control through communication will not perform.
Multi-SV	By combinational logic of the digital input(DI-1,DI-2), it is possible to select multi SV NO. (SV-0 to SV-3), but it is not possible to select multi SV NO. through communication.

- In the case one of DI-1 or DI-2 being set for Multi SV, SV-0 is selected as the SV if the terminal's external contact signal is off and SV-1 is selected if the signal is on.
- If both DI-1 and DI-2 are configured for Multi SV, you can select the SV using combinational logic of the terminals. If changes multi SV from 4 to 2, the DI-2 will be automatically turned off. If changes multi SV from 4 to 1, both DI-1 and DI-2 will be turned off.

DI-1	DI-2	Multi SV No.
OFF	OFF	SV-0
ON	OFF	SV-1
OFF	ON	SV-2
ON	ON	SV-3

Setting group	Parameter	Setting range	Factory default	Unit
Digital Input Setting	Digital Input 1 Func	OFF, STOP, AL-RESET	OFF	-
	Digital Input 2 Func	Manual, Multi-SV	OFF	-



Note

Multi SV parameter will be activated only if Multi SV is more than 2.

6.9.2 Digital input terminal target channel

Users can set a target channel to which digital input terminal function will be applied.

Setting group	Parameter	Setting range	Factory default	Unit
Digital Input Setting	Digital Input1 Ch	CH1, CH2	CH1	-
	Digital Input2 Ch		CH2	-

6.10 Error

The controller diagnoses input signals for errors and displays messages accordingly. These messages inform the user of device problems. Once the cause of the error is solved (sensor connected/return to display range), the error status is released and the device continues to run normally.

- The following conditions may result in errors. When an error occurs, the display LED at the front flashes at 0.5 second intervals.
 - The sensor input is higher than operational temperature range.
 - The sensor input is lower than operational temperature range.
 - Input sensor is disconnected or not connected.



Note

- When power is on, or in standard control or heating mode, the controller outputs 0% if HHHH is displayed and 100% if LLLL is displayed.
- When power is on, or in standard control or cooling mode, the controller outputs 100% if HHHH is displayed and 0% if LLLL is displayed.
- In heating and cooling mode, when power is on or in standard control, heating output is 0% and cooling output is 100% if HHHH is displayed; heating output 100% and cooling output is 0% if LLLL is displayed.
- Output priority in manual control: Heating(Cooling)_MV > Stop_MV > Sensor Error_MV
- Output priority in automatic control: Stop_MV > Sensor Error_MV > Heating(Cooling)_MV

6.10.1 Sensor error, MV setting

This feature sets control output when a sensor open error occurs. Users can configure ON/OFF, MV settings, etc.

Ignores MV by ON/OFF control or PID control, and sends out a control value based on the defined MV.

Setting group	Preceding condition		Parameter	Setting range	Factory default	Unit
Control Setting	Heating, Cooling	PID	Sensor Error MV	0.0 to 100.0	0.0	%
		ON/OFF		0.0 (OFF)/100.0 (ON)		
	Heating & Cooling	PID		-100.0 (Cool) to 100.0 (Heat)	0.0	
		ON/OFF		-100.0 (Cool ON) /0.0 (OFF) /100.0 (Heat ON)		

6.11 Parameter initialization

This option resets all parameters in memory to factory defaults.

Setting group	Parameter	Setting range	Factory default	Unit
Communication Setting	Parameter Initialize	YES, NO	NO	-



Note

If selecting "Yes", all parameters will be initialized and temperature control will be by factory default.

However, communication parameters are not initialized.

7 Simple Error Diagnosis

7.1 Error display

Indicator \ Status	Disconnected input sensors	Out of temperature range
PWR (red)	ON	
CH□ (red) ^{※1}	Flash (for 0.5 sec. in turn)	
Comm. output (decimal)	Outputs '31000'	Outputs '30000(high-limit)', '-30000(low-limit)'
DAQMaster	Displays 'OPEN'	Displays 'HHHH(high-limit)', 'LLLL(low-limit)'

※1. The applied CH LED indicator flashes.

7.2 Troubleshooting

(1) LED indicators flash (for 0.5 sec. in turn), or external device displays OPEN

- Check input sensor setting.
- Disconnect the power and check the input connection.
- If input is connected, disconnect the input wiring from the temperature controller and short the + and - terminals. Power the temperature controller and check if the external device displays the room temperature. If it does not display the room temperature and continues to display HHHH or LLLL, the controller is broken. Please contact our technical support. (input type is thermocouple)

(2) Output does not operate normally.

- Check that CH indicators for control output operates normally.
- If CH indicators for control output does not operates, check the parameter settings.
- If CH indicators for control output operates, remove the control output connector and check the output.

(3) External device receives no-response or abnormal data.

- Check the communication converter (SCM-38I, SCM-US48I or SCM-US, sold separately).
- Do not install communication converter line and AC power supply lines.
- Use different communication converter power and temperature controller power.
- Indicates damage to internal chip by strong noise.
- Please contact our technical support. Locate the source of the noise device countermeasures.

(4) Communication does not work between TM and external device

- Check the communication converter power and connections.
- Check the communication settings.
- Check the temperature controller and external device connections.

8 DAQMaster

8.1 Overview

DAQMaster is a comprehensive device management program that can be used with Autonics thermometer, meter, and counter products, and with Konics recorder products.

DAQMaster provides GUI control for easy and convenient management of parameters and multiple device data monitoring.

The screenshot displays the DAQMaster software interface with the following components:

- Project:** A tree view showing the project structure, including a 'Runtime UI' folder with sub-items like Grid, Panel, Line Graph, Bar Graph, and Color Map.
- DAQ WorkSpace:** A central area containing several monitoring panels:
 - Grid:** A table listing 6 devices (TK4) with their respective tag names (e.g., 1_Present Value, 1_Set Value, 1_Heating MV, 1_°C Lamp, 1_OUT1 Lamp, 1_AL1 Lamp).
 - Line Graph:** A line chart showing data over time (13:11:30 to 13:12:00).
 - Color Map Graph:** A color scale visualization.
 - 1_Present Value:** A large digital display showing '25 °C'.
 - Bar Graph:** A bar chart showing data for two devices.
 - Gauge Graph:** A circular gauge showing '001' for '1_Present Value'.
- My System:** A table showing system configuration:

Name	Address
RS-232	COM4
Modbus Master	RTU
TK4	AUTONICS
TK 4S 14RR	
- Property:** A panel on the right showing 'Run UI' settings, including 'Update Interval' set to '1000 msec'.
- DAQ List:** A table at the bottom listing all tags:

Type	Num	Num	Device	Address	Source	Tag Name	Type	R/W	Unit	Description
Standard Tags										
AI	5	1	TK4	1	Present Value	1_Present Value	AI	R	°C	
AO	0	1	TK4	1	Set Value	1_Set Value	AI	R	°C	
DI	14	1	TK4	1	Heating MV	1_Heating MV	AI	R	%	
DO	0	1	TK4	1	Cooling MV	1_Cooling MV	AI	R	%	
VIDEO	0	1	TK4	1	Heater Current M...	1_Heater Current Monitoring	AI	R	A	
		1	TK4	1	°C Lamp	1_°C Lamp	DI	R		



Note

For more information, visit our website (www.autonics.com) to download "DAQMaster user manual".

8.2 Features

DAQMaster has the following features:

- **Multiple device support**
Simultaneously monitor multiple devices and set parameters.
Simultaneously connect units with different addresses in a single device.
Use Modbus remote terminal unit to enable the use of multiple RS-232 ports.
- **Device scan**
In cases of multiple units (with different addresses) connected together, use unit scan to automatically search for units.
- **Convenient user interface**
Freely arrange the windows for data monitoring, attributes, and projects.
Saving a project also saves the screen layout.
- **Project management**
You can save added device information, data monitoring screen layouts, and I/O source selection as project files. Open project files to load the saved settings.
Provides a project list for simple and easy project file management.
- **Monitoring data log**
When monitoring, save data log files as either DAQMaster data files (.ddf) or CSV (.csv) files. Open files saved in the .csv format directly from Microsoft Excel.
Define log data file naming/saving rules and destination folders to make file management convenient.
- **Data analysis**
Perform spreadsheet and graph analyses of .ddf data files using DAQMaster's data analysis feature. Save spreadsheet data as .rtf, .txt, .html, or .csv files.
- **Modbus map table reporting**
Print address map reports of registered Modbus devices. Modbus map table reports can be saved in .html and .pdf formats.
- **Multilingual support**
Supports Korean, English, Japanese and Simplified Chinese.
To add a different language, modify the files in the Lang folder, rename, and save.
- **Script support**
Uses the Lua Script language and deals with different I/O processes for individual devices.

Autonics

Sensors & Controllers

Distributor



Major Products

- Photoelectric Sensors • Fiber Optic Sensors • Door Sensors • Door Side Sensors • Area Sensors
- Proximity Sensors • Pressure Sensors • Rotary Encoders • Connector/sockets
- Switching Mode Power Supplies • Control Switches/Lamps/Buzzers • Temperature Controllers
- Temperature/Humidity Transducers • SSR/Power Controllers • Counters • Timers • Panel Meters
- Tachometer/Pulse(Rate) Meters • Display Units • Sensor Controllers
- I/O Terminal Blocks & Cables • Stepper Motors/Drivers/Motion Controllers
- Graphic/Logic Panels • Field Network Devices • Laser Marking System(Fiber, CO, Nd:YAG)
- Laser Welding/Cutting System

Any proposal for a product improvement and development: Product@autonics.com

- ☺ **Headquarters**
 18, Bansong-ro 513beon-gil, Haerundae-gu, Busan, South Korea, 48002 www.autonics.com
- **Overseas Business Headquarters**
 #402-303, Bucheon Techno Park, 655, Pyeongcheon-ro, Wonmi-gu, Bucheon, Gyeonggi-do, South Korea, 14502
 Tel: 82-32-610-2730 / Fax: 82-32-329-0728 / E-mail: sales@autonics.com
- **Brazil Autonics do Brasil Commercial Importadora Exportadora Ltda**
 Rua Dr. Licinio Maragliano, 369 Sarto Amaro - Sao Paulo - SP - CEP: 04753-130, Brazil
 Tel: 55-11-2307-8480 / Fax: 55-11-2309-7784 / E-mail: vendas@autonics.com.br
- **China Autonics electronic(JiXiang) Corporation**
 #301 YUN HAI ROAD jiaxing, Zhejiang, China, 314001
 Tel: 86-21-5422-5969 / Fax: 86-21-5422-5961 / E-mail: china@autonics.com
- **India Autonics Automation India Private Limited**
 Fantasia Business Park Unit No- G 174 & 175, Plot No.47, Sector 30A,Vashi, Navi Mumbai, India 400 703.
 Tel: 91-22-2781-4305 / Fax: 91-22-2781-4518 / E-mail: india@autonics.com
- **Indonesia PT. Autonics Indonesia**
 Jl.Dewi Sartika No. 171, Jakarta Timur
 Tel: 62-21-8088-8815 / Fax: 62-21-8088-4440 / E-mail: indonesia@autonics.com
- **Japan Autonics Japan Corporation**
 645-1, MIKAMACHI, MINOWA-MACHI, KAMINA-GUN, NAGANO-KEN 399-4603 JAPAN
 Tel: 81-265-79-8570 / Fax: 81-265-79-2442 / E-mail: support@autonicsjp.co.jp
- **Malaysia Mal-Autonics Sensor Sdn. Bhd.**
 Unit No 613 & 614, Block A, Kelana Business Centre 97, Jalan SS7/2, Kelana Jaya, 47301 Petaling Jaya, Selangor Malaysia.
 Tel: 60-3-7805-7190(Hunting) / Fax: 60-3-7805-7193 / E-mail: malaysia@autonics.com
- **Mexico Autonics Mexico S.A. DE C.V**
 Av. Doctor Gustavo Baz Prada no. 98 Int. 7ºFrac. Industrial Alca Blanco, Naucalpan de Juarez, Estado de Mexico C.P. 53370
 Tel: 52-55-5207-0019 / Fax: 52-55-1663-0712 / E-mail: informes@autonics.com
- **Russia Autonics Corp, Russia Representative Office**
 Office 2008, entrance "B", section 3, str. Ulofa Palme, 1, Moscow, 119590, Russia
 Tel/Fax: 7-495-660-10-88 / E-mail: russia@autonics.com
- **Turkey Autonics Otomasyon Ticaret Ltd. Sti.**
 Serifali Mh. Turker Cd. Burhan Sk. No:23 Kat:2 Umraniye, Istanbul, Turkey
 Tel: 90-216-365-9117(9113, 9114) / Fax: 90-216-365-9112 / E-mail: info@autonics.com.tr
- **USA Autonics USA, Inc.**
 1353 Armour Blvd, Mundelein, IL 60060, USA
 Tel: 1-847-680-8160 / Fax: 1-847-680-8155 / E-mail: sales@autonicsusa.net
- **Vietnam Cong Ty TNHH Autonics Vina**
 Nguyen Hung Phu Office Building, No.400 Nguyen Thi Thap Street,
 Tan Quy Ward, District 7, Ho Chi Minh City, Vietnam
 Tel: 84-8-3771-2662 / Fax: 84-8-3771-2663 / E-mail: vietnam@autonics.com