

## Vision Sensor

### ■ Features

- Light integrated vision sensor
- Minimized image distortion with global shutter method
- Proprietary technology to block optical interference to improve optical performance (patent)
- Stronger in environment of vibration or impact with lens cover detachment prevention technology
- Various inspection function  
: Alignment, brightness, contrast, area, edge, shape comparison, length, angle, diameter, object counting, color identification, area of color, object of color counting
- Inspection test with simulator
- Flexible response to changing work environment by setting 32 work groups (64 inspection items for each work group)
- Saving data to FTP server
- Free vision sensor program (Vision Master)  
: Inspection simulator, managing parameter and work group, monitoring inspection result, inspection result FTP transmission, multilingual support, Etc.
- Protection structure IP67 (IEC standard)



**⚠ Please read "Safety Considerations" in the instruction manual before using.**



### ■ Manual

For the detail information and instructions, please refer to user manual, and be sure to follow cautions written in the technical description (catalog, website).

Visit our website ([www.autonics.com](http://www.autonics.com)) to download manuals.

### ■ Ordering Information

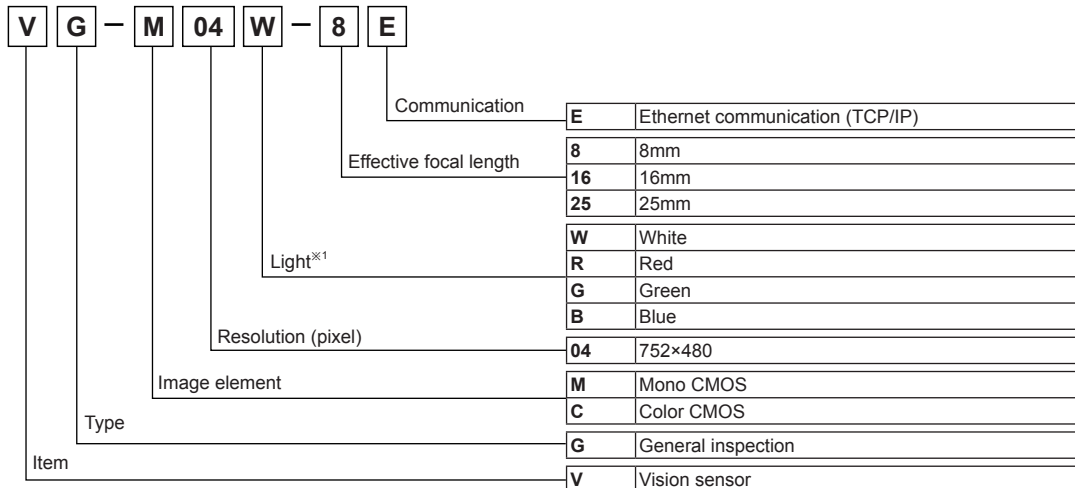

※1: Light can be purchased separately.

SENSORS

CONTROLLERS

MOTION DEVICES

SOFTWARE

(A) Photoelectric Sensors

(B) Fiber Optic Sensors

(C) LiDAR

(D) Door/Area Sensors

(E) Vision Sensors

(F) Proximity Sensors

(G) Pressure Sensors

(H) Rotary Encoders

(I) Connectors/ Connector Cables/ Sensor Distribution Boxes/ Sockets

# VG Series

## Overall Configuration Diagram

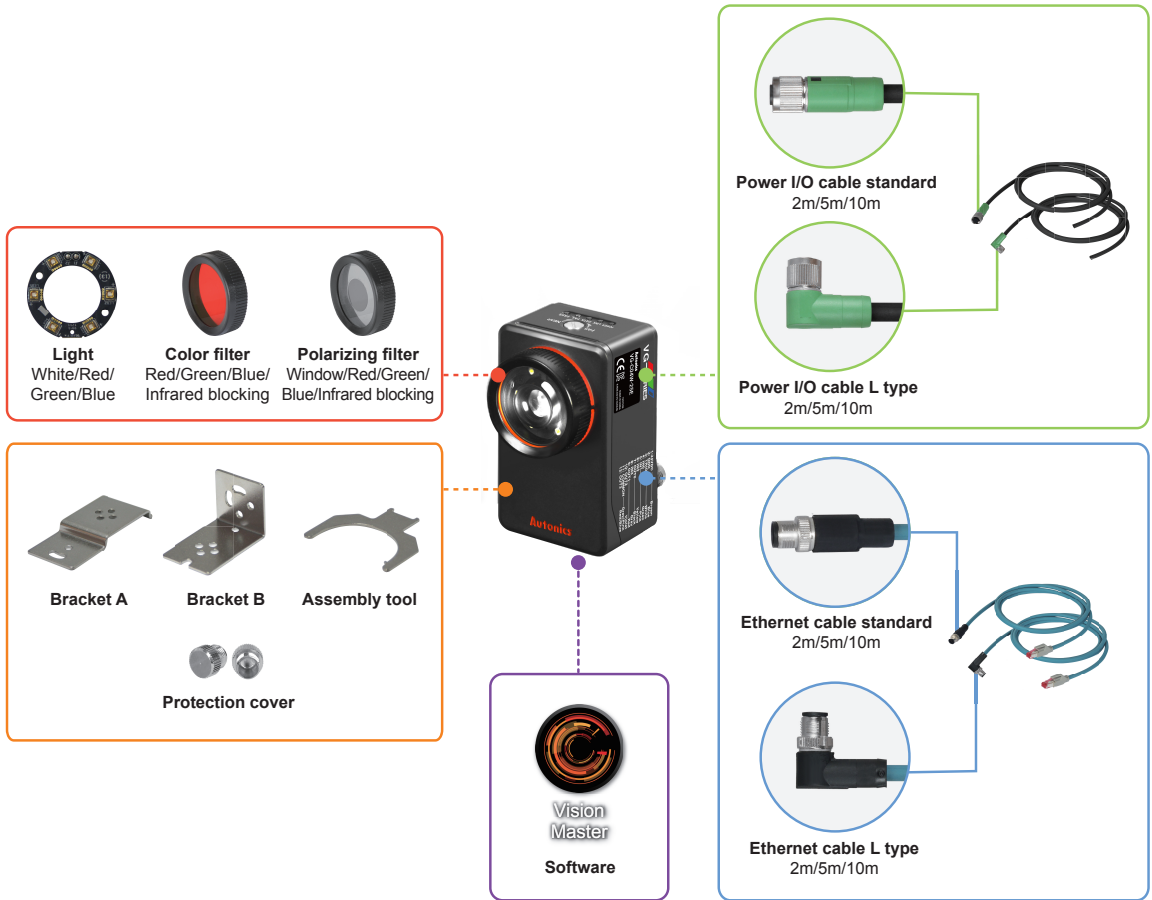

## ■ Accessories

- Assembly tool
- ASST-VG



- Bracket A
- BK-VG-A



## ■ Sold Separately

- Light
- LR-W-06-VG (white)
- LR-R-06-VG (red)
- LR-G-06-VG (green)
- LR-B-06-VG (blue)

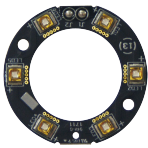

- Bracket B
- BK-VG-B



- Panel PC
- APC-1011



- Protection cover
- P96-M12-1



※Protection cover protects the unused connector from foreign object. When installing, hand tighten.

- Color filter
- FL-R-VG (red)



- FL-G-VG (green)



- FL-B-VG (blue)

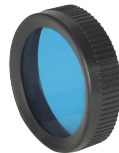

- FL-IC-VG (infrared blocking)



- Polarizing filter
- FL-P-VG (window)



- FL-RP-VG (red)



- FL-GP-VG (green)



- FL-BP-VG (blue)



- FL-ICP-VG (infrared blocking)



- Power I/O cable
- Standard
- CID-2-VG (2m)
- CID-5-VG (5m)
- CID-10-VG (10m)



- L type
- CLD-2-VG (2m)
- CLD-5-VG (5m)
- CLD-10-VG (10m)



- Ethernet cable
- Standard
- CIR-2-VG (2m)
- CIR-5-VG (5m)
- CIR-10-VG (10m)



- L type
- CLR-2-VG (2m)
- CLR-5-VG (5m)
- CLR-10-VG (10m)



SENSORS

CONTROLLERS

MOTION DEVICES

SOFTWARE

(A) Photoelectric Sensors

(B) Fiber Optic Sensors

(C) LIDAR

(D) Door/Area Sensors

(E) Vision Sensors

(F) Proximity Sensors

(G) Pressure Sensors

(H) Rotary Encoders

(I) Connectors/ Connector Cables/ Sensor Distribution Boxes/ Sockets

# VG Series

## Specifications

Model	VG-M04□-8E	VG-M04□-16E	VG-M04□-25E	VG-C04□-8E	VG-C04□-16E	VG-C04□-25E
Effective focal length	8mm	16mm	25mm	8mm	16mm	25mm
Min. working distance	50mm	100mm	200mm	50mm	100mm	200mm
Power supply	24VDC $\pm$ (±10%)					
Current consumption	1A					
Inspection	Inspection item	Alignment, brightness, contrast, area, edge, shape comparison, length, angle, diameter, object counting			Alignment, brightness $\times^2$ , contrast $\times^2$ , area $\times^2$ , edge, shape comparison $\times^2$ , length, angle, diameter, object counting $\times^2$ , color identification, area of color, object of color counting	
	Work group	32				
	Simultaneous inspection	64				
	Camera frame per second $\times^1$	Max. 60fps				
Image snap	Image filter	Preprocessing, external filter (color filter, polarizing filter)				
	Image element	1/3 inch mono CMOS			1/3 inch color CMOS	
	Resolution	752×480 pixel				
	Camera frame per second $\times^1$	Max. 60fps				
	Shutter	Global shutter				
	Exposure time	20 to 50,000 $\mu$ s				
Light	ON/OFF method	Pulse				
	Color	White, red, green, blue				
Trigger mode	External trigger, internal trigger, free-run trigger					
Input	Signal	Rated input 24VDC $\pm$ (±10%)				
	Type	External trigger (TRIG), work group change (IN0 to IN3), alarm cleared (IN0 to IN3), encoder (IN2, IN3)				
Output	Signal	NPN or PNP open collector output Max. 24VDC $\pm$ 50mA, residual voltage: max. 1.2VDC $\pm$				
	Type	Control output (OUT0 to OUT3) : inspection completion, inspection result, external light trigger, alarm, camera busy, changing work group completed				
	FTP transmission	Possible				
Communication	Ethernet (TCP/IP), 100BASE-TX/10BASE-T					
Protection circuit	Output short over current protection circuit					
Indicator	<ul style="list-style-type: none"> <li>• Power indicator (POWER), Ethernet connection indicator (LINK), pass indicator (PASS): green LED</li> <li>• Data transmission indicator (DATA): orange LED</li> <li>• Failure indicator (FAIL): red LED</li> </ul>					
Insulation resistance	Over 20M $\Omega$ (at 500VDC megger)					
Dielectric strength	500VAC 50/60Hz for 1 min					
Vibration	1.5mm amplitude at frequency of 10 to 55Hz (for 1 min) in each X, Y, Z direction for 2 hours					
Shock	300m/s $^2$ (approx. 30G) in each X, Y, Z direction for 3 times					
Environment	Ambient temp.	0 to 45°C, storage: -20 to 70°C				
	Ambient humi.	35 to 85%RH, storage: 35 to 85%RH				
Protection structure	IP67 (IEC standard)					
Material	Case: aluminum, lens cover/focus adjuster: polycarbonate, cable: polyurethane					
Accessories	Assembly tool, bracket A, mounting screw: 2					
Sold separately	Light, color filter, polarizing filter, power I/O cable, Ethernet cable, bracket B, protection cover, panel PC					
Approval	CE 					
Weight $\times^3$	Approx. 415g (approx. 273g)	Approx. 416g (approx. 274g)	Approx. 416g (approx. 274g)	Approx. 415g (approx. 273g)	Approx. 416g (approx. 274g)	Approx. 416g (approx. 274g)

※1: The number of camera frames per second can be different by image setting or inspection item.

※2: These inspection items convert a color image to a mono color image to inspect data.

※3: The weight includes packaging. The weight in parenthesis is for unit only.

※Environment resistance is rated at no freezing or condensation.



## ■ Connections

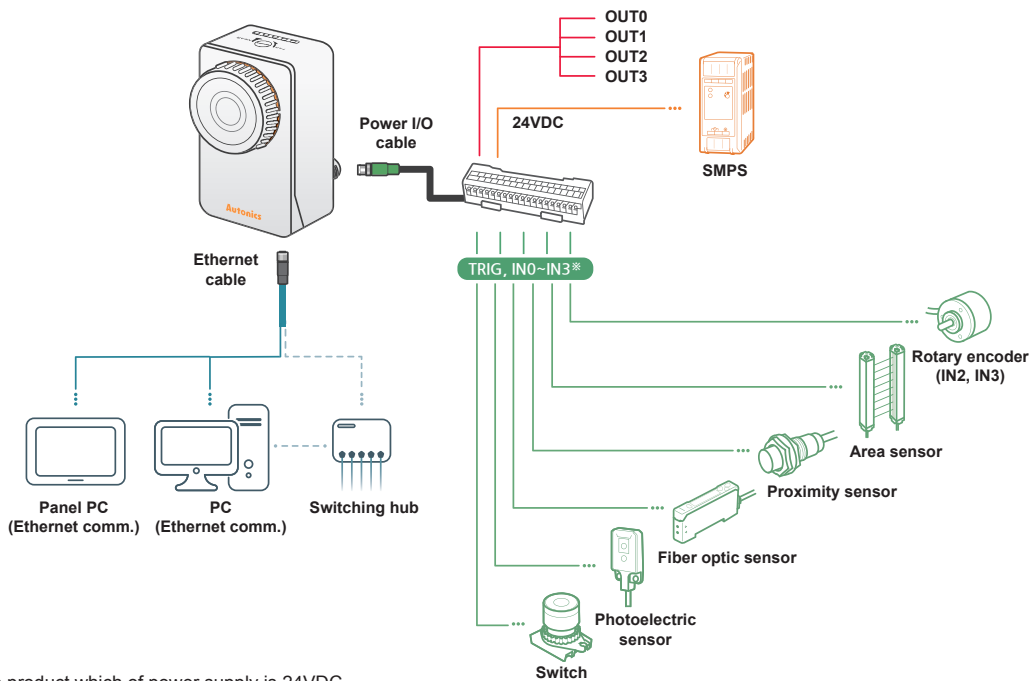

※ Use the product which of power supply is 24VDC.  
When selecting a product, please refer to Autonics selection guide.

### ○ Power I/O cable (M12 12-pin connector)

Pin arrangement	Pin No.	Cable color	Signal	Function		
	1	Brown	24VDC	24VDC		
	2	Blue	GND	GND		
	3	White	TRIG	Trigger input		
	4	Green	IN0	Work group change Bit 0	Work group change Clock	
	5	Pink	IN1	Work group change Bit 1	Work group change Data	
	6	Yellow	IN2	Work group change Bit 2	Encoder - Up counter - Quadrature A	Alarm cleared
	8	Gray	IN3	Work group change Bit 3	Encoder - Down counter - Quadrature B	
	11	Gray/Pink	COMMON	COMMON		
	7	Black	OUT0	Inspection completion, inspection result, external light trigger, alarm, camera busy, changing work group completed		
	9	Red	OUT1			
	10	Purple	OUT2			
	12	Red/Blue	OUT3			

### ○ Ethernet cable (M12 8-pin/RJ45 connector)

Pin arrangement	M12 8-pin		Cable color	RJ45	
	Pin No.	Signal		Pin No.	Signal
	6	RX+	White/Orange	1	TX+
	4	RX-	Orange	2	TX-
	5	TX+	White/Green	3	RX+
	8	TX-	Green	6	RX-
	1	—	White/Blue	5	—
	7	—	Blue	4	—
	2	—	White/Brown	7	—
	3	—	Brown	8	—

SENSORS

CONTROLLERS

MOTION DEVICES

SOFTWARE

(A) Photoelectric Sensors

(B) Fiber Optic Sensors

(C) LIDAR

(D) Door/Area Sensors

(E) Vision Sensors

(F) Proximity Sensors

(G) Pressure Sensors

(H) Rotary Encoders

(I) Connectors/  
Connector Cables/  
Sensor Distribution  
Boxes/ Sockets

# VG Series

## Input Circuit Diagram

- External trigger input (TRIG)  
Work group change input (IN0 to IN3)  
Alarm cleared input (IN0 to IN3)

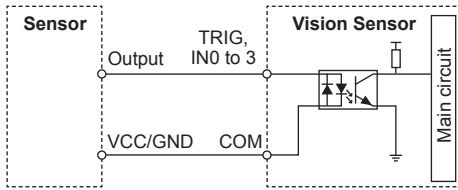

- Encoder input (IN2, IN3)

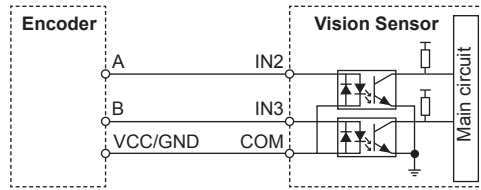

## Control Output Circuit Diagram

- NPN open collector output

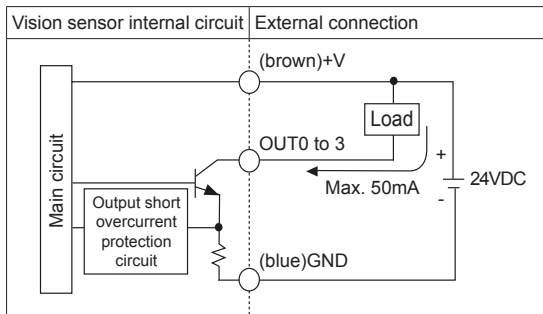

- PNP open collector output

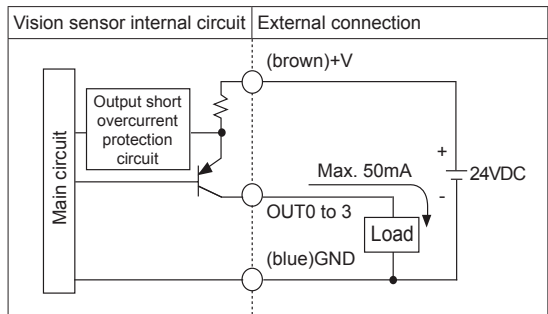

## Unit Description

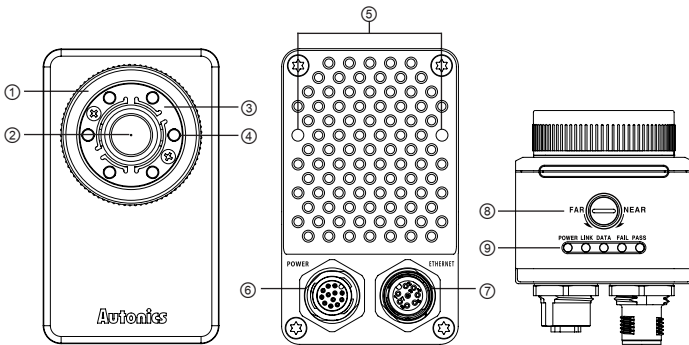

- ① Lens cover: Front cover of lens  
※In case using a filter (color filter/polarizing filter), separate the lens cover with the assembly tool before insert the filter.
- ② Lens: There are 8mm, 16mm, 25mm models by effective focal length.
- ③ Light cover: Light cover fixes inner LED lights.
- ④ Light: Inner LED lights  
※In order to change the light, separate lens cover and light cover.
- ⑤ Bracket mounting hole on back side: Install the vision master from the back side using bracket B.
- ⑥ Power I/O connector: Connect the power I/O cable.
- ⑦ Ethernet connector: Connect the Ethernet cable. It is for TCP/IP communication.
- ⑧ Focus adjuster: After fixing vision sensor, adjust focus by rotating the focus adjuster.
- ⑨ Indicators

Indicators	Color	Descriptions
POWER Power indicator	Green LED	Turns ON when power is supplied.
LINK Ethernet connection indicator	Green LED	Turns ON when vision sensor is connected with PC (Ethernet communication).
DATA Data transmission indicator	Orange LED	Flashes when data is transmitted from vision sensor to PC.
FAIL Failure indicator	Red LED	Flashes when detects failure during work group inspection.
PASS Pass indicator	Green LED	Flashes when passed inspection during work group inspection.

## Dimensions

(unit: mm)

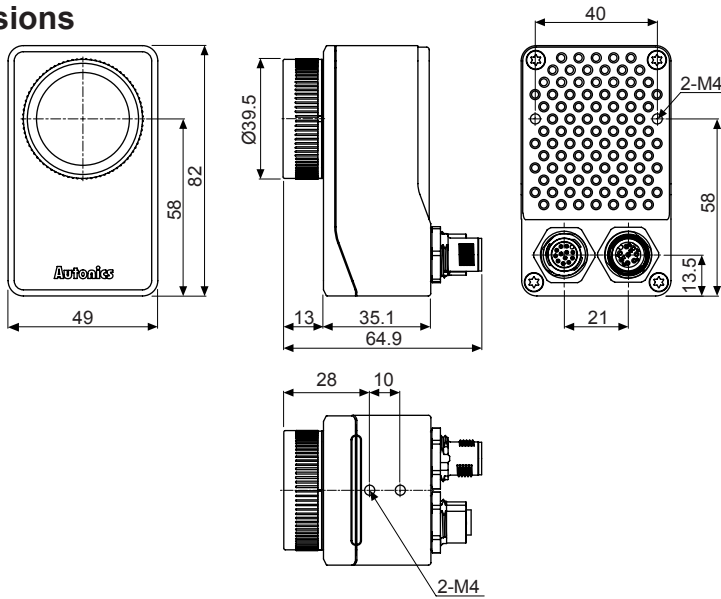

## Accessory

### ● Bracket A (BK-VG-A)

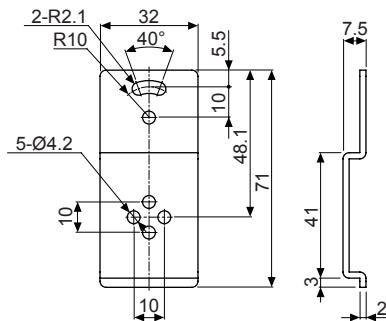

## Sold separately

### ● Bracket B (BK-VG-B)

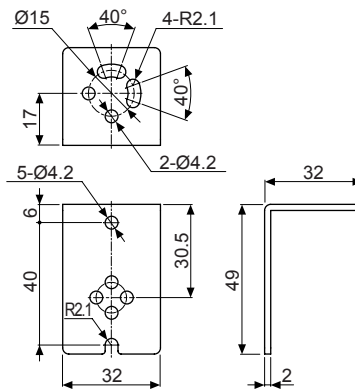

### ● Power I/O cable (M12 12-pin connector)

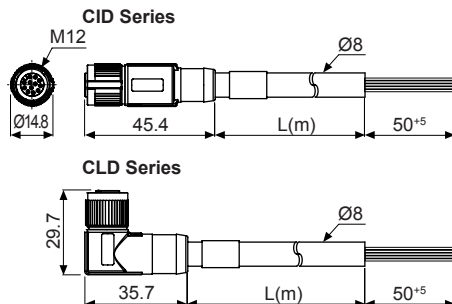

Type	Model	L
Standard	CID-2-VG	2m
	CID-5-VG	5m
	CID-10-VG	10m
L type	CLD-2-VG	2m
	CLD-5-VG	5m
	CLD-10-VG	10m

### ● Ethernet cable (M12 8-pin/RJ45 connector)

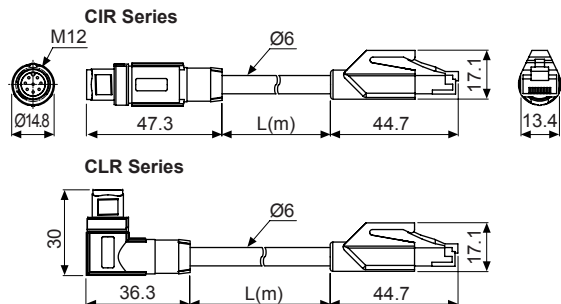

Type	Model	L
Standard	CIR-2-VG	2m
	CIR-5-VG	5m
	CIR-10-VG	10m
L type	CLR-2-VG	2m
	CLR-5-VG	5m
	CLR-10-VG	10m

SENSORS
CONTROLLERS
MOTION DEVICES
SOFTWARE

(A) Photoelectric Sensors
(B) Fiber Optic Sensors
(C) LIDAR
(D) Door/Area Sensors
(E) Vision Sensors
(F) Proximity Sensors
(G) Pressure Sensors
(H) Rotary Encoders
(I) Connectors/Connector Cables/Sensor Distribution Boxes/ Sockets

# VG Series

## ■ Installation

### Installing vision sensor

- Checking working distance and FOV by effective focal length
- Bracket installation (fixing vision sensor)

### Installing software

- Installing the vision sensor program, Vision Master, to PC

### Connecting vision sensor and PC

- Setting network from Vision Master

### Adjusting vision sensor focus

- Running Vision Master and activating the 'Focusing Guide' function in the camera setting menu
- Adjusting focus with focus adjuster

## ○ Bracket installation

- Install horizontally from the bottom
  - bracket A (accessory)

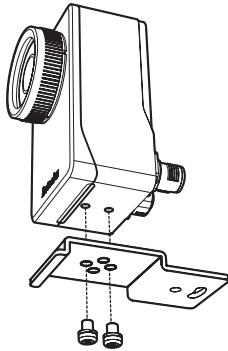

- Install vertically from the bottom
  - bracket B (sold separately)

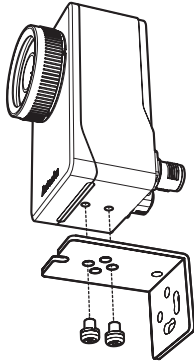

- Install vertically from the back side
  - bracket B (sold separately)

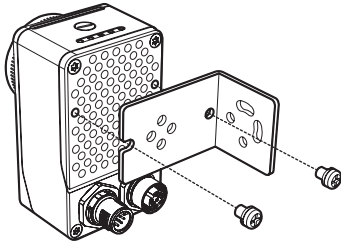

## ○ Installation position

Place the sensing target at the center of the vision sensor lens.

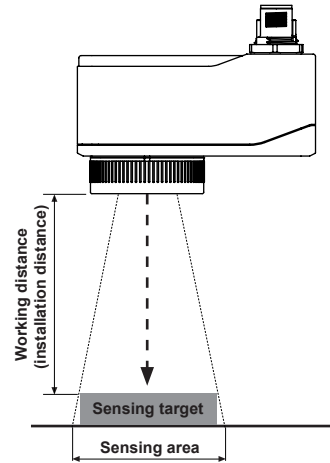

## ○ Focus adjustment

After installing and running Vision Master, use the focusing guide function to adjust the focus. Using (-) screwdriver, turn focus adjuster to right and left to adjust the focus.

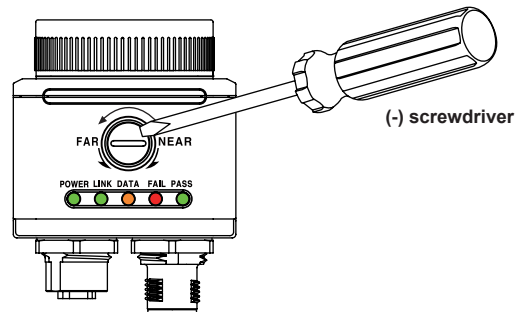

## Working Distance and FOV by Effective Focal Length

### Working distance

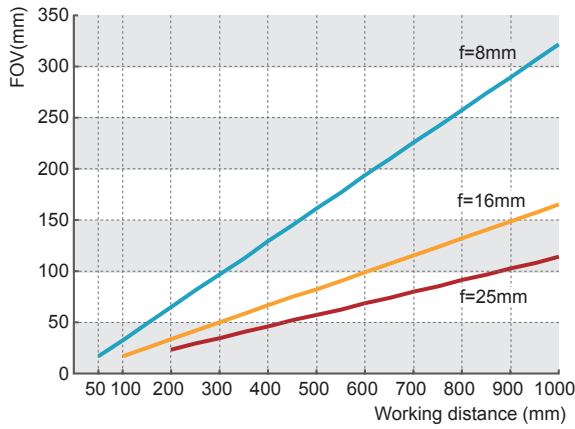

Effective focal length (f)	8mm	16mm	25mm
Min. working distance	50mm	100mm	200mm
Brightness	F2.0	F2.5	F2.5

### FOV (Field of view)

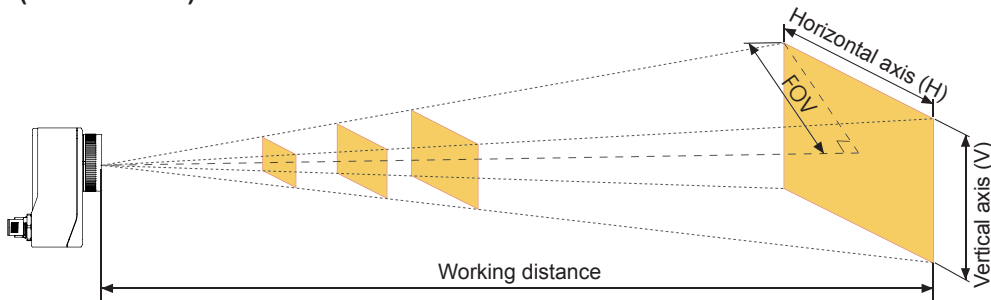

### Sensing range by effective focal length (unit: mm)

Effective focal length	Working distance	50	100	200	300	400	500	600	700	800	900	1,000
8mm	FOV	16	32	64	96	129	161	193	255	257	289	322
	Horizontal axis (H)	27	54	108	163	217	271	325	380	434	488	542
	Vertical axis (V)	17	35	69	104	138	173	208	242	277	311	346
16mm	FOV	—	16	33	49	66	82	99	155	132	148	165
	Horizontal axis (H)	—	28	56	83	111	139	167	195	222	250	278
	Vertical axis (V)	—	18	35	53	71	89	106	124	142	160	177
25mm	FOV	—	—	23	34	46	57	68	80	91	103	114
	Horizontal axis (H)	—	—	38	58	77	96	115	134	154	173	192
	Vertical axis (V)	—	—	25	37	49	61	74	86	98	110	123

SENSORS

CONTROLLERS

MOTION DEVICES

SOFTWARE

(A) Photoelectric Sensors

(B) Fiber Optic Sensors

(C) LIDAR

(D) Door/Area Sensors

(E) Vision Sensors

(F) Proximity Sensors

(G) Pressure Sensors

(H) Rotary Encoders

(I) Connectors/ Connector Cables/ Sensor Distribution Boxes/ Sockets

# VG Series

## ■ Vision Sensor Program [Vision Master]

Vision Master is the vision sensor program that allows setting of vision sensor parameters and management of monitoring data such as inspection status and status information.

<Computer specification for using software>

Item	Minimum specifications
System	32bit (x86) or 64bit (x64) processor over 1GHz
Operations	Microsoft Windows 7/8/10
Memory	1GB+
Hard disk	400MB+ of available hard disk space
VGA	Resolution: 1024×768 or higher
Others	RJ45 Ethernet port

<Vision Master execution screen>

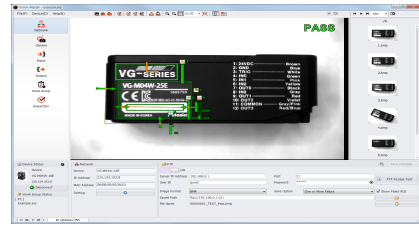

※Vision sensor is connected with Vision Master in Ethernet (TCP/IP) communication.

※For initial IP address of vision sensor, refer to the following table. Configure the network settings of vision sensor via Vision Master.

IP address	192.168.0.2
Subnet mask	255.255.255.0
Gateway	192.168.0.1

<Inspection setting screen>

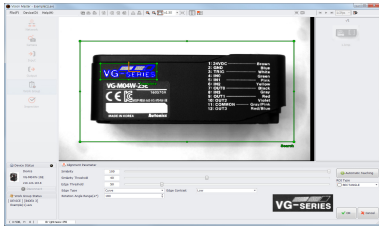

<Inspection executing screen>

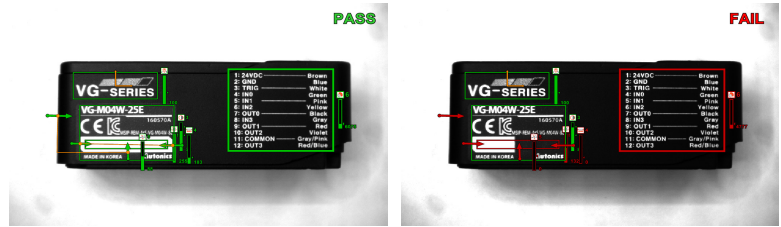

<FTP transmission setting screen>

FTP  ON Save Changes

Server IP Address: 192.168.0.1 Port: 21 FTP Access Test

User ID: guest Password: \*\*\*\*\*

Image Format: BMP Save Option: One or More Failure  Show Failed ROI

Saved Path: ftp://192.168.0.1:21/ File Name: 00000001\_TEST\_Pass.bmp

<Registered inspections in work group>

Number	Work	Result
1	Alignment 1	Pass
2	Brightness 1	Pass
3	Contrast 1	Pass
4	Area 1	Pass
5	Edge 1	Pass
6	Length 1	Pass
7	Angle 1	Pass
8	Diameter 1	Pass
9	Object Counting 1	Pass

<Inspection status monitoring screen>

Number	Work Name	Result Value	Result	Pass/Fail	Operating Time(ms)
1	Alignment 1	82 [X:377 Y:250 R:0.2]	●	103/0(100.0%)	562.72
2	Brightness 1	153	●	78/25(75.7%)	0.19
3	Contrast 1	69	●	87/16(84.4%)	1.02
4	Area 1	5179	●	94/9(91.2%)	0.37
5	Edge 1	0 [Distance:8]	●	94/9(91.2%)	9.63
6	Length 1	0	●	89/14(86.4%)	0.82
7	Angle 1	100	●	100/3(97.0%)	23.00
8	Diameter 1	68 [Round:88]	●	100/3(97.0%)	86.24
				817/110(88.1%)	694.26

**Input Trigger** 2.3%

Pass 103

Fail 4352

**- Work** 46.6%

All Pass 48

One or More Failure 55

The Number of Works 9

Overall Inspection Time(ms) 728

## ○ Vision Master Work Flow

### ● Setting mode

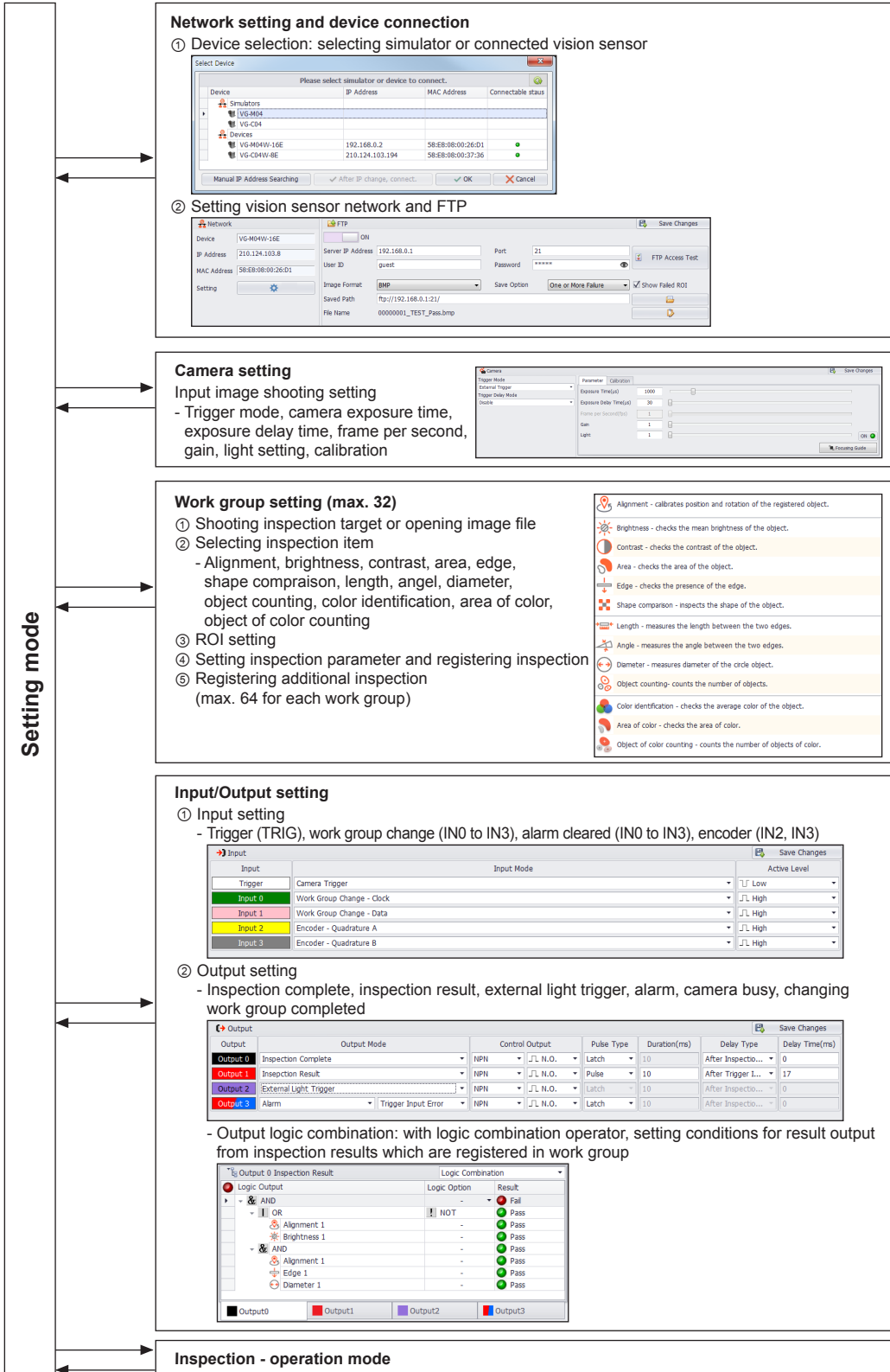

SENSORS

CONTROLLERS

MOTION DEVICES

SOFTWARE

(A) Photoelectric Sensors

(B) Fiber Optic Sensors

(C) LiDAR

(D) Door/Area Sensors

(E) Vision Sensors

(F) Proximity Sensors

(G) Pressure Sensors

(H) Rotary Encoders

(I) Connectors/ Connector Cables/ Sensor Distribution Boxes/ Sockets





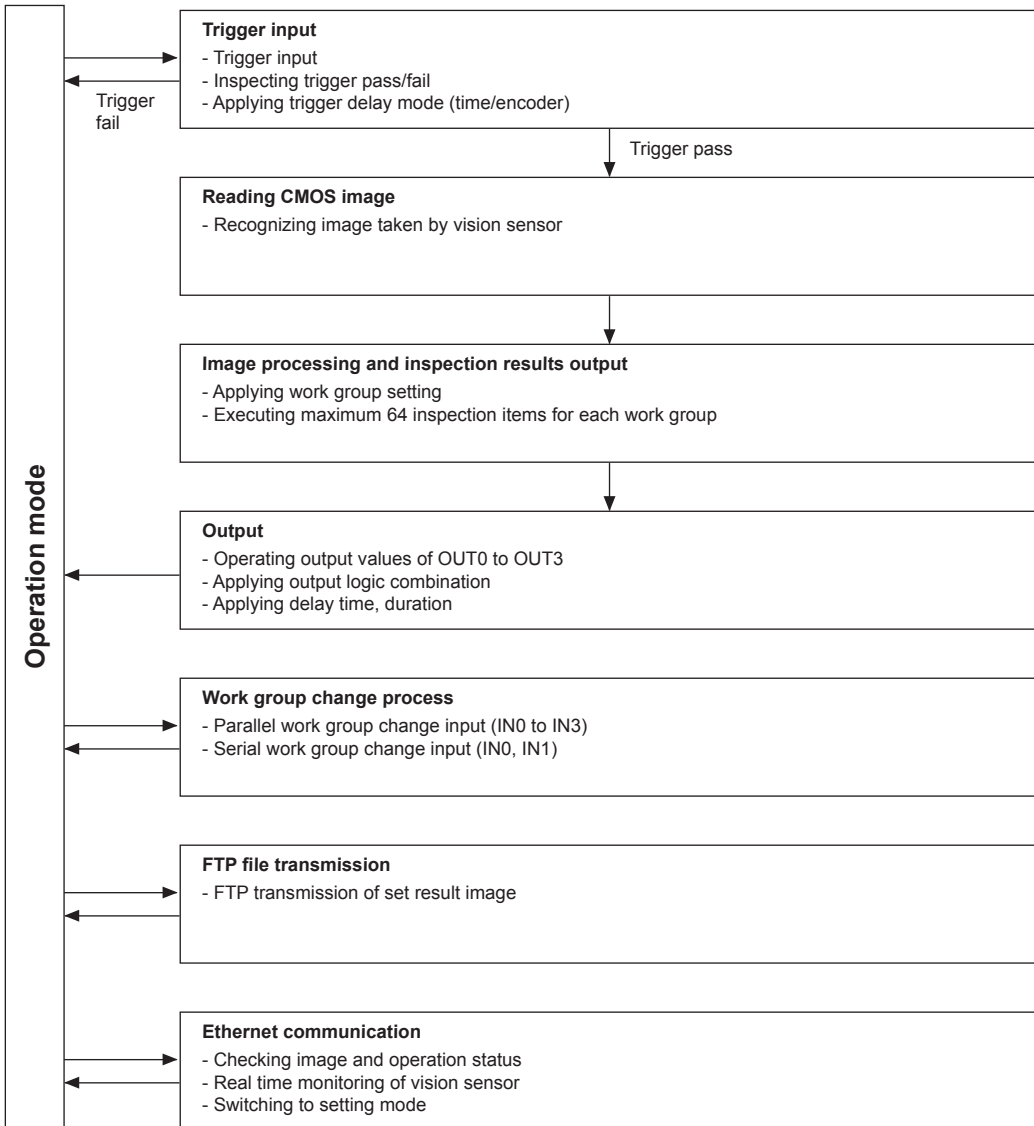







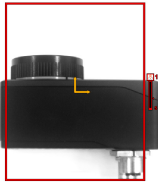

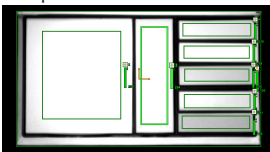
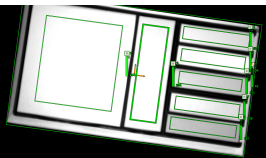

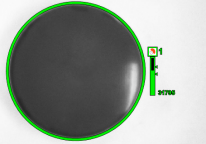
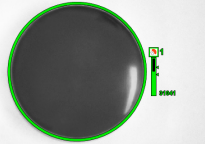
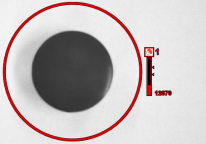

## ○ Vision Master Work Flow

### ● Operation mode



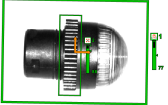

## ○ Inspection function

Item	Description		
 Alignment	Compares features of the registered image and input image to search for a similar pattern position, and inspects the input image with information of the searched pattern position and rotation angle.		
	<Template> 	<Pass> 	<Fail> 
 Brightness	Inspects brightness of the ROI in the input image based on the mean brightness value of the ROI (Region of Interest) in the registered image.		
	<Template> 	<Pass> 	<Fail> 
 Contrast	Inspects contrast of the ROI in the input image based on contrast of the ROI in the registered image.		
	<Template> 	<Pass> 	<Fail> 
 Area	Inspects the ROI area of the input image based on the ROI area of the image registered by user.		
	<Template> 	<Pass> 	<Fail> 
 Edge	Inspects the direction of the edge in the input image based on the edge registered by user in the same area.		
	<Template> 	<Pass> 	<Fail> 
 Shape comparison	Compares shape of object in the ROI registered by user and that of the input image.		
	<Template> 	<Pass> 	<Fail> 

SENSORS

CONTROLLERS

MOTION DEVICES

SOFTWARE

(A) Photoelectric Sensors

(B) Fiber Optic Sensors

(C) LIDAR

(D) Door/Area Sensors

(E) Vision Sensors









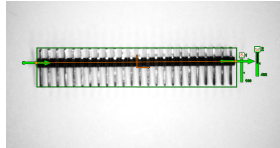
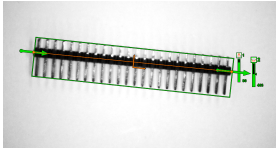
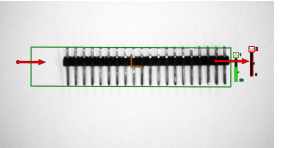

(F) Proximity Sensors

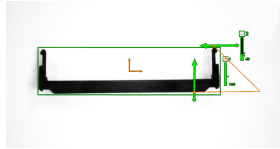
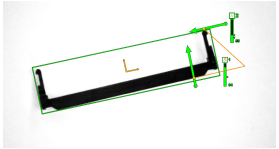
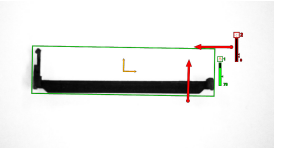
(G) Pressure Sensors

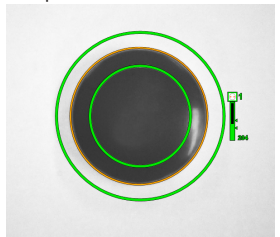
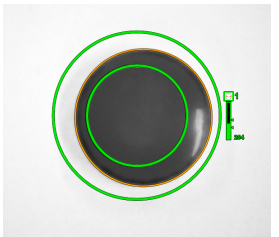
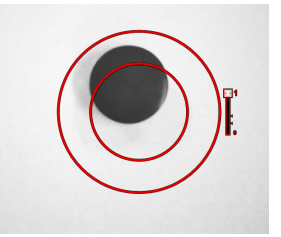
(H) Rotary Encoders

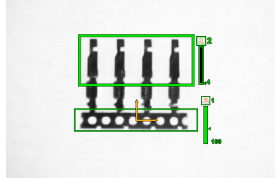
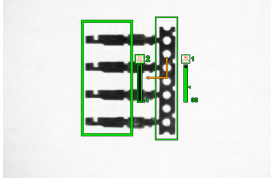
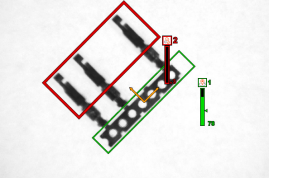

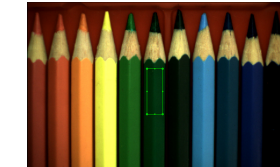
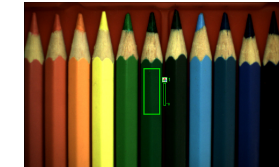
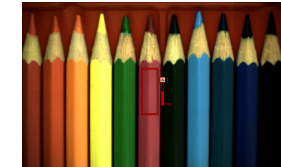
(I) Connectors/ Connector Cables/ Sensor Distribution Boxes/ Sockets

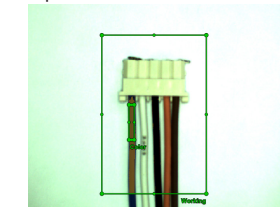
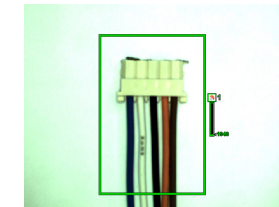
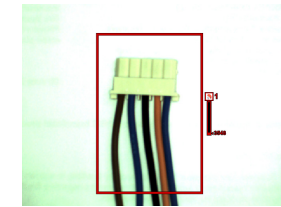
# VG Series

Item	Description		
 <p>Length</p>	<p>Inspects the input image based on the length between two edges registered by user.</p> <p>&lt;Template&gt;  &lt;Pass&gt;  &lt;Fail&gt; </p>		
 <p>Angle</p>	<p>Inspects the input image based on the angle between two edges registered by user.</p> <p>&lt;Template&gt;  &lt;Pass&gt;  &lt;Fail&gt; </p>		
 <p>Diameter</p>	<p>Inspects the input image based on the area between two circles registered by user.</p> <p>&lt;Template&gt;  &lt;Pass&gt;  &lt;Fail&gt; </p>		
 <p>Object counting</p>	<p>Compares the number of objects in the ROI which is in the image registered by user and that in the input image.</p> <p>&lt;Template&gt;  &lt;Pass&gt;  &lt;Fail&gt; </p>		
 <p>Color identification</p>	<p>Compares color of the ROI registered by user and that of the input image.</p> <p>&lt;Template&gt;  &lt;Pass&gt;  &lt;Fail&gt; </p>		
 <p>Area of color</p>	<p>Compares the area of a certain color in the ROI registered by user and that in the input image.</p> <p>&lt;Template&gt;  &lt;Pass&gt;  &lt;Fail&gt; </p>		

※These examples include position alignment. (except area, diameter, color identification, area of color, and object of color counting inspection)  
 ※Color identification, area of color, and object of color counting are only for VG-C Series.

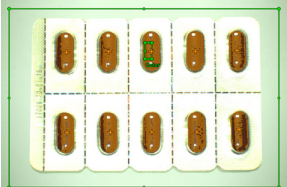
## ○ Inspection function

Item	Description
 <p>Object of color counting</p>	<p>Compares the number of objects in a certain color which are in the ROI of registered image and that of the input image.</p> <div style="display: flex; justify-content: space-around;"> <div data-bbox="330 317 637 535"> <p>&lt;Template&gt;</p>  </div> <div data-bbox="644 317 950 535"> <p>&lt;Pass&gt;</p>  </div> <div data-bbox="957 317 1264 535"> <p>&lt;Fail&gt;</p>  </div> </div>

※ These examples include position alignment. (except area, diameter, color identification, area of color, and object of color counting inspection)  
 ※ Color identification, area of color, and object of color counting are only for VG-C Series.

## ■ Proper Usage

### ◎ Cautions during Use

- Follow instructions in Cautions during Use. Otherwise, it may cause unexpected accidents.
- 24VDC power supply should be insulated and limited voltage/current or Class 2, SELV power supply device.
- In order to avoid malfunction from static electricity or noise, ground shield wire of the power I/O cable.
- Do not disconnect the power supply while setting operation or saving set information.  
It may cause data loss.
- Do not disconnect the power supply while updating firmware. It may cause product damage.
- Keep optical section of the sensor away from the contact with water, dust and oil.  
It may cause malfunction.
- When changing the light or filter, use the assembly tool and observe installation instruction.
- When the sensor is not used for a long time, separate the power cable to store.
- When connecting network, connection must be operated by technical expert.
- In the following case, disconnect the power supply immediately. It may cause fire or product damage.
  - ① When water or foreign substance is detected in the product
  - ② When the product is dropped or case is damaged
  - ③ When smoke or smell is detected from the product
- Do not use the product in the place where strong magnetic field or electric noise is generated.
- This unit may be used in the following environments.
  - ① Indoor (in the environment conditions in specifications)
  - ② Altitude max. 2,000m
  - ③ Pollution degree 2
  - ④ Installation category II

SENSORS

CONTROLLERS

MOTION DEVICES

SOFTWARE

(A) Photoelectric Sensors

(B) Fiber Optic Sensors

(C) LiDAR

(D) Door/Area Sensors

(E) Vision Sensors

(F) Proximity Sensors

(G) Pressure Sensors

(H) Rotary Encoders

(I) Connectors/ Connector Cables/ Sensor Distribution Boxes/ Sockets