

PTZ310/330
PTZ310W/330W
Professional PTZ Camera

User Manual



FCC NOTICE (Class A)



This device complies with Part 15 of the FCC Rules. The operation is subject to the following two conditions: (1) this device may not cause harmful interference, and (2) this device must accept any interference received, including interference that may cause undesired operation.

Federal Communications Commission Statement

NOTE- This equipment has been tested and found to comply with the limits for a Class A digital device, pursuant to Part 15 of the FCC Rules. These limits are designed to provide reasonable protection against harmful interference in a residential installation. This equipment generates uses and can radiate radio frequency energy and, if not installed and used in accordance with the instructions, may cause harmful interference to radio communications. However, there is no guarantee that interference will not occur in a particular installation. If this equipment does cause harmful interference to radio or television reception, which can be determined by turning the equipment off and on, the user is encouraged to try to correct the interference by one or more of the following measures:

- Reorient or relocate the receiving antenna.
- Increase the separation between the equipment and receiver.
- Connect the equipment into an outlet on a circuit different from that to which the receiver is connected.
- Consult the dealer or an experienced radio/television technician for help.

Class A ITE

Class A ITE is a category of all other ITE which satisfies the class A ITE limits but not the class B ITE limits. Such equipment should not be restricted in its sale but the following warning shall be included in the instructions for use:

Warning - This is a class A product. In a domestic environment, this product may cause radio interference in which case the user may be required to take adequate measures.

European Community Compliance Statement (Class A)



This product is herewith confirmed to comply with the requirements set out in the Council Directives on the Approximation of the laws of the Member States relating to Electromagnetic Compatibility Directive 2014/30/EU.

Warning - This is a Class A product. In a domestic environment, this product may cause radio interference in which case the user may be required to take adequate measures to correct this interference.

DISCLAIMER

No warranty or representation, either expressed or implied, is made with respect to the contents of this documentation, its quality, performance, merchantability, or fitness for a particular purpose. Information presented in this documentation has been carefully checked for reliability; however, no responsibility is assumed for inaccuracies. The information contained in this documentation is subject to change without notice.

In no event will AVer Information Inc. be liable for direct, indirect, special, incidental, or consequential damages arising out of the use or inability to use this product or documentation, even if advised of the possibility of such damages.

TRADEMARKS

“AVer” is a trademark owned by AVer Information Inc. Other trademarks used herein for description purpose only belong to each of their companies.

COPYRIGHT

©2018 AVer Information Inc. All rights reserved.

All rights of this object belong to AVer Information Inc. Reproduced or transmitted in any form or by any means without the prior written permission of AVer Information Inc. is prohibited. All information or specifications are subject to change without prior notice.

NOTICE

SPECIFICATIONS ARE SUBJECT TO CHANGE WITHOUT PRIOR NOTICE. THE INFORMATION CONTAINED HEREIN IS TO BE CONSIDERED FOR REFERENCE ONLY.

Remote Control Battery Safety Information

- Store batteries in a cool and dry place.
- Do not throw away used batteries in the trash. Properly dispose of used batteries through specially approved disposal methods.
- Remove the batteries if they are not in use for long periods of time. Battery leakage and corrosion can damage the remote control. Dispose of batteries safely and through approved disposal methods.
- Do not use old batteries with new batteries.
- Do not mix and use different types of batteries: alkaline, standard (carbon-zinc) or rechargeable (nickel-cadmium).
- Do not dispose of batteries in a fire.
- Do not attempt to short-circuit the battery terminals.

WARNING

- To reduce the risk of fire or electric shock, do not expose this appliance to rain or moisture. Warranty will be void if any unauthorized modifications are done to the product.
- Do not drop the camera or subject it to physical shock.
- Use the correct power supply voltage to avoid the damaging camera.
- Do not place the camera where the cord can be stepped on as this may result in fraying or damage to the lead or the plug.
- Hold the bottom of the camera with both hands to move the camera. Do not grab the lens or lens holder to move the camera.

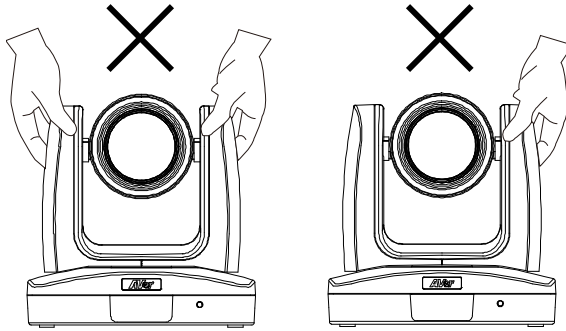

OK

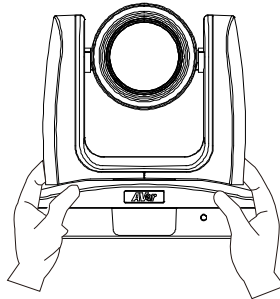

Contents

Package Contents.....	1
Product Introduction.....	2
Overview	2
LED Indicator.....	2
Pan and Tilt Angle	3
Device Connection	3
Video Output Connection	4
RS232 and RS422 Connection	5
Audio Input Connection	7
PoE Connection	7
Remote Controller	9
Setup the Camera.....	11
OSD Menu.....	11
Setup IP Address of the Camera	12
Static IP	12
DHCP	12
OSD Tree	13
Camera	13

Video Output.....	14
Network	14
Advanced Setting.....	14
System.....	15
Web Setup.....	16
Using the AVer IPCam Utility to Find the Camera.....	16
Make a Connection to the Camera via Browser	17
Live View	18
Pan-Tilt-Zoom Control.....	18
Focus.....	19
Manual Pan-Tile-Zoom and Preset Speed Adjustment	19
Preset	20
Camera Settings.....	21
Exposure	21
Image Process.....	21
Video & Audio.....	22
Network	23
RTMP Setting	23
Advanced Setting	24

SmartShoot.....	24
SmartFrame.....	26
System	26
Using RTSP Connect to Camera.....	26
Firmware Update.....	27
Web Firmware Update.....	27
USB Update.....	27
RS232 Command Table	29
Specification.....	34
PTZ310/310W	34
PTZ330/330W	37

Package Contents

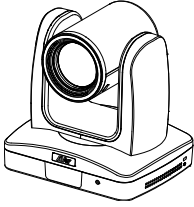

PTZ310/PTZ330
PTZ 310W/PTZ330W

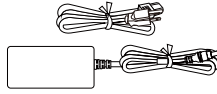

Power adapter &
Power cord

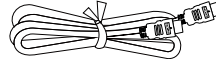

HDMI cable



Remote controller



4 to 3 pin MIC In cable



Quick Guide

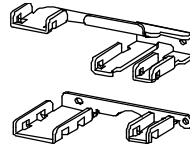

Cable Fixing plate

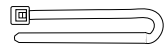

Cable ties(x5)



Batteries(x2)



Screw for
wall mount

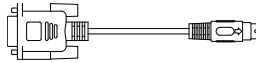

Din8 to D-Sub9 cable

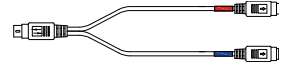

RS232 In/Out cable

*The power cord will vary depending on the standard power outlet of the country where it is sold.

Product Introduction

Overview

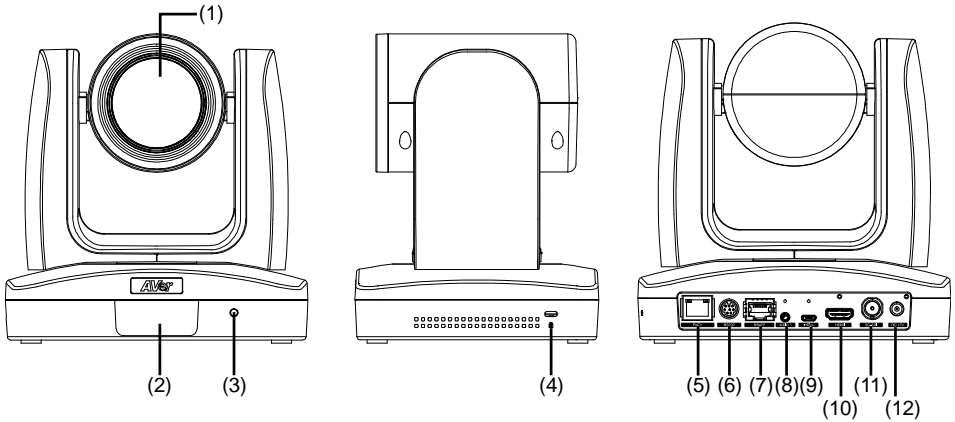

(1) Camera lens	(5) PoE+ port	(9) mini-USB port
(2) IR sensor	(6) RS232 port	(10) HDMI port
(3) LED indicator	(7) RS422 port	(11) 3G-SDI port
(4) Kensington lock	(8) Audio IN	(12) DC Power jack

LED Indicator

LED	Status
Blue(Solid)	Normal Operation
Orange(Blinking)	Camera Initialization
Orange (Solid)	Standby
Red(Blinking)	FW Updating

Pan and Tilt Angle

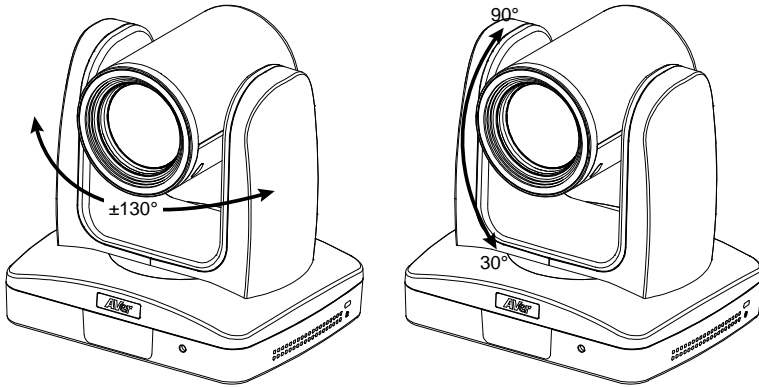

Device Connection

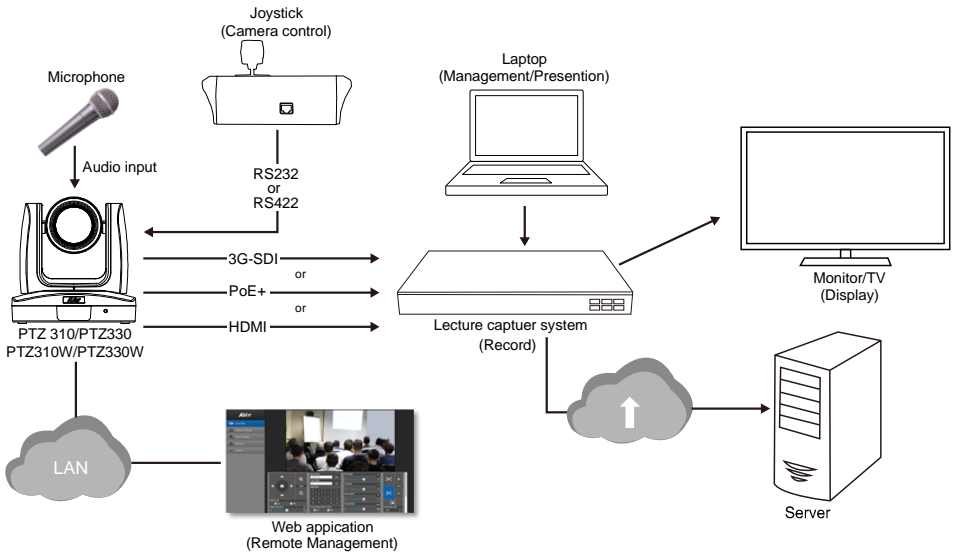

Video Output Connection

■ HDMI

Use the HDMI cable to connect with monitor or TV for video output.

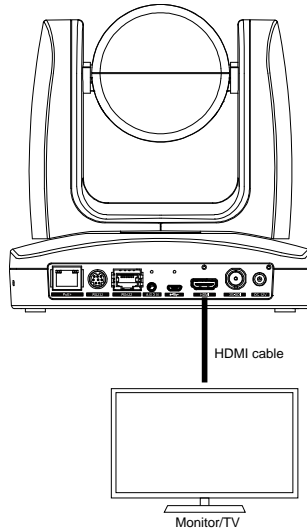

■ 3G-SDI

Connect to 3G-SDI monitor for video output.

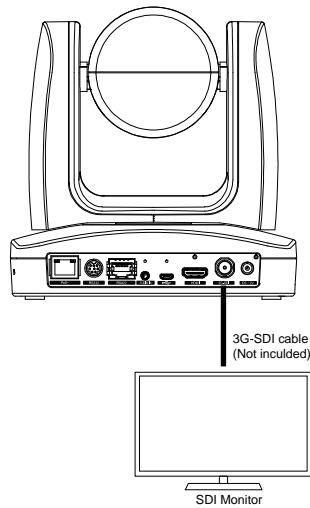

[Note] HDMI and 3G-SDI monitors can be connected to camera and output live video simultaneously; Assuming HDMI monitor is well connected before the camera turned on, the OSD menu will be displayed on HDMI monitor in default.”

RS232 and RS422 Connection

Connect through the RS232 or RS422 for camera control.

■ RS232

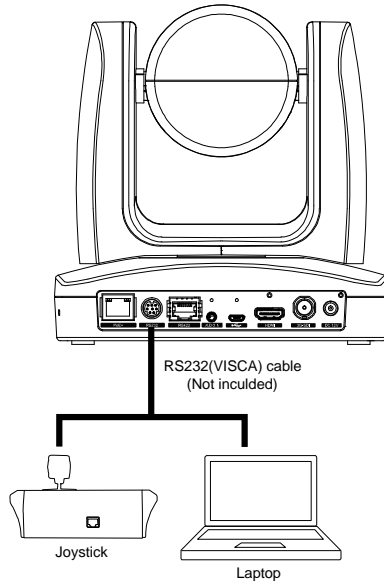

● RS232 Port Pin definition

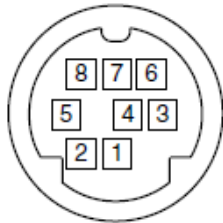

RS232 Pin	
No.	Pin
1	DTR
2	DSR
3	TXD
4	GND
5	RXD
6	GND
7	NC
8	NC

● Din8 to D-Sub9 Cable Pin definition

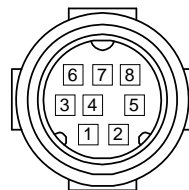
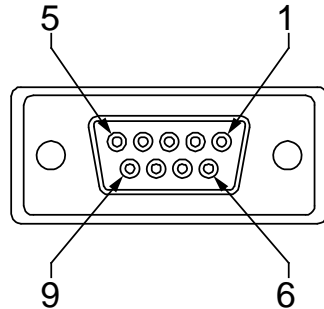

■ RS422

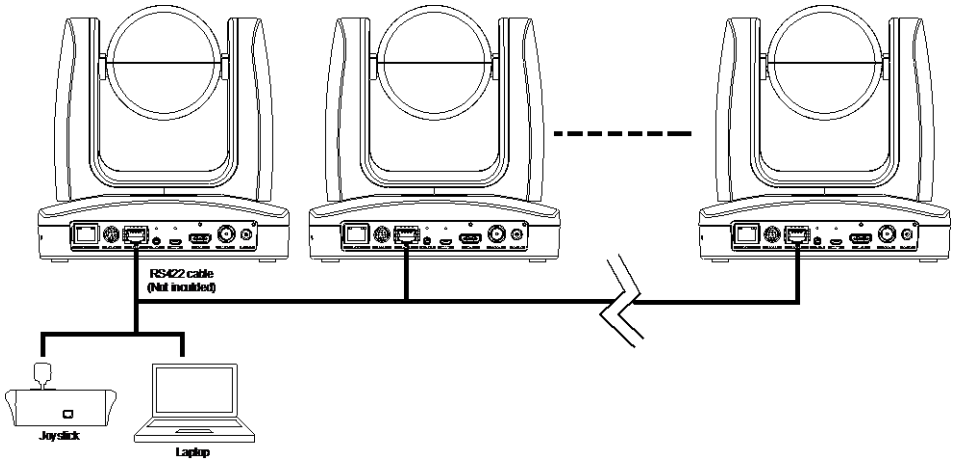

[Note] Use cat5e splitter for multi-camera connection.

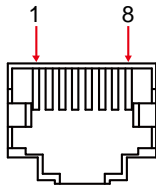

RS422 Pin			
No.	Pin	No.	Pin
1	TX-	5	TX+
2	TX+	6	RX+
3	RX-	7	RX-
4	TX-	8	RX+

Cat5e splitter pin assignment:

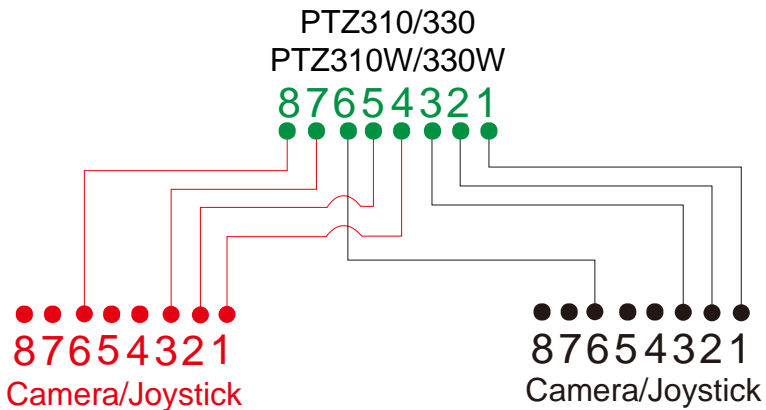

Audio Input Connection

Connect the audio device for audio receiving.

[Note] If use MIC-in device (ex: microphone), please use 3 to 4 MIC-in cable to connect camera and MIC-in device.

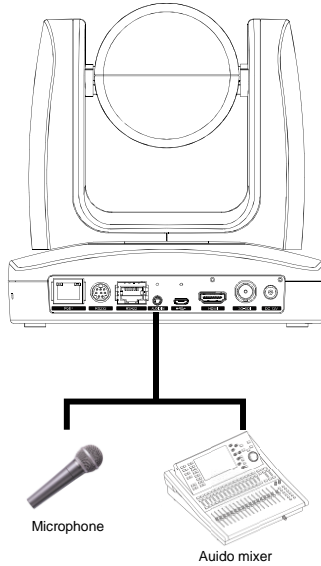

PoE Connection

Connect the camera to the router or switch through the PoE+ port.

[Note] Only support IEEE 802.3AT PoE+ standard.

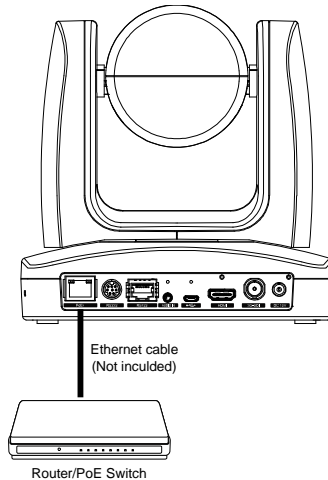

Install Cable Fixing Plate

- 1 Secure the cable fixing plate to the camera with screws.

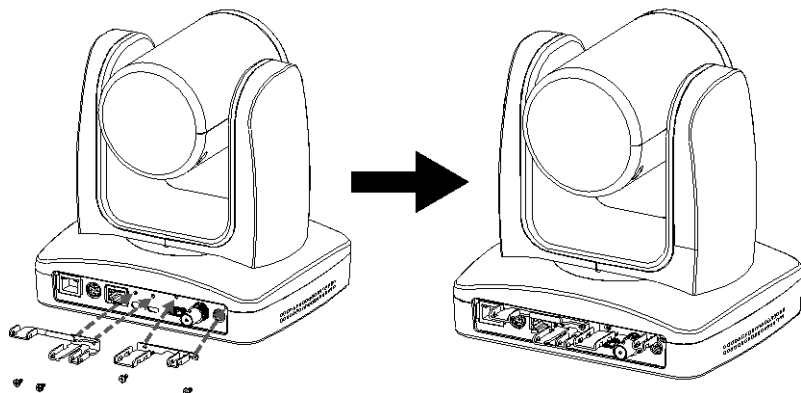

- 2 Plug-in cables.

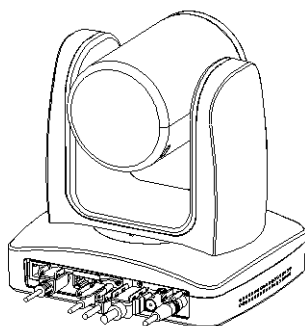

- 3 Using cable ties to secure the cable and cable fixing plate.

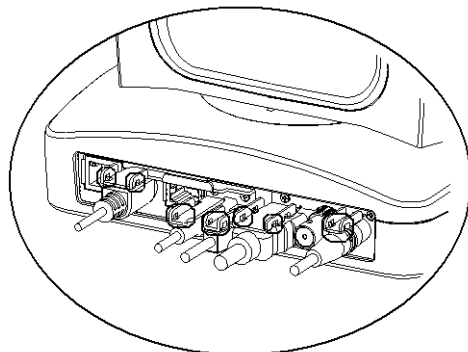

Remote Controller

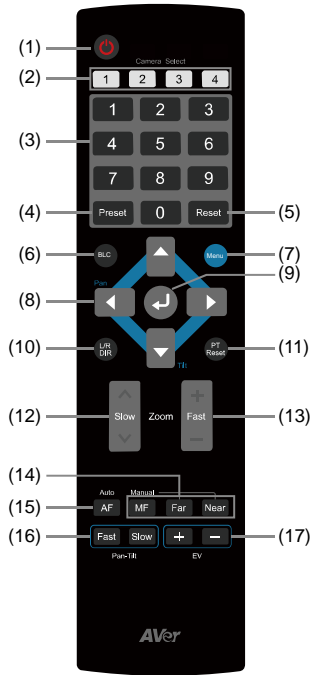

Name	Function
(1) Power	Turn the unit on/standby.
(2) Camera Select	Select 1~4 PTZ camera. Set the camera ID in OSD menu: System > Camera Selector, ex: camera ID is set to 1. Then, press the “camera select” button “1” to control the camera.
(3) Numeric Pad	<ul style="list-style-type: none"> ■ Use for setting the preset position 0~9. ■ Press number button (0~9) to move the camera to pre-configure preset position 0~9.
(4) Preset	Press “ Preset ” + “ Number button (0~9) ” to set the preset position.
(5) Reset	Press “ Reset ” + “ Number button (0~9) ” to cancel the pre-configure preset position.
(6) BLC	Turn on/off backlight compensation
(7) Menu	Open and exit the OSD menu.
(8) ▲, ▼, ◀, & ▶	Pan and tilt the camera lens.
(9) 	<ul style="list-style-type: none"> - Confirm the selection or make a selection in OSD menu. - One push focus.
(10) L/R DIR	Left and right orientation setting. <ul style="list-style-type: none"> - Press “L/R DIR” + “#1” button to reset setting. - Press “L/R DIR” + “#2” button to move to opposite direction.

Name	Function
(11) PT Reset	Reset the Pan-Tilt position.
(12) Zoom Slow	Zoom in/out slow.
(13) Zoom Fast	Zoom in/out fast.
(14) MF/Far/Near	Enable manual focus. Use Far/Near to adjust the focus.
(15) AF	Auto focus.
(16) Pan-tilt Fast/Slow	Pan-Tilt speed adjustment. There are totally 24 levels for pan-tilt speed adjustment; press the button once will adjust fast or slow one level of speed (also see Manual Pan-Tile-Zoom and Preset Speed Adjustment chapter).
(17) EV +/-	EV level adjustment.

Setup the Camera

OSD Menu

Press  button on the remote controller to call out the OSD menu and use ▲, ▼, ◀, ▶ and ↵ button to operate the OSD menu.

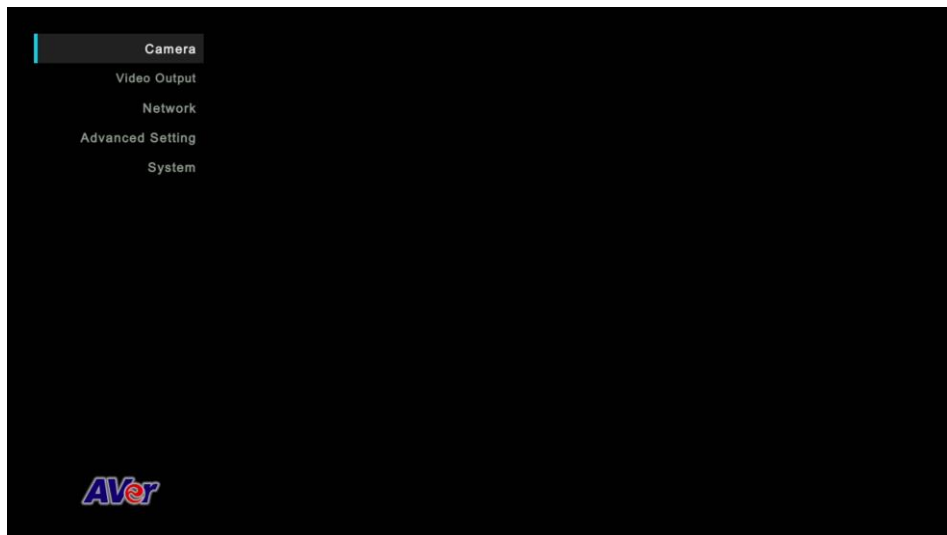

Setup IP Address of the Camera

Static IP

1. Press  button on the remote controller to call out OSD menu.
2. Go to **Network > Static IP**.

[Note] Turn the DHCP off before setup static IP (Network > DHCP > Off).

3. Select the **IP address, Gateway, Mask, and DNS** to configure. Press  and use , , number pad to enter the data.

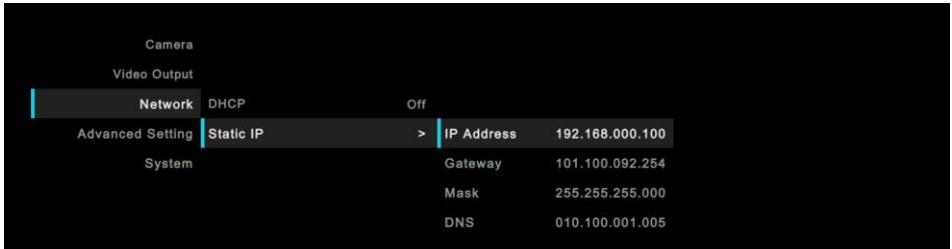

DHCP

1. Press  button on the remote controller to call out OSD menu.
2. Go to **Network > DHCP > On**.



3. After turn the DHCP on, the user can go to **System > Information** to view IP address.

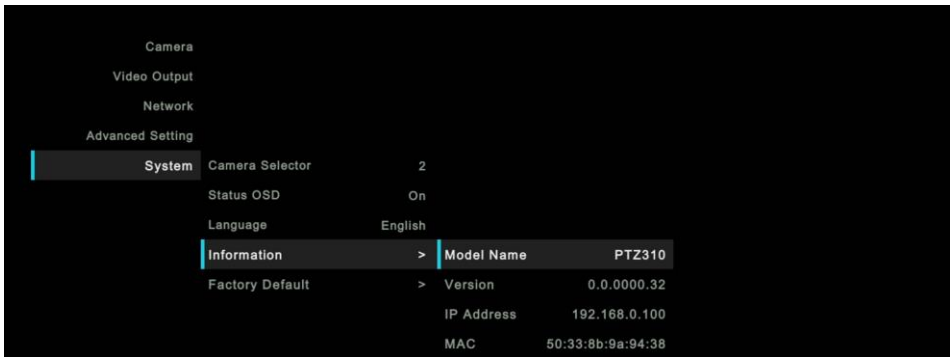

OSD Tree

Camera

Setup camera parameters – Exposure mode, White balance, Pan-Tilt Zoom, Noise reduction, Frequency, Saturation, Contrast, Sharpness, Mirror, and Flip.

Camera	Exposure Mode	
	Full Auto	Exposure Value/Gain Limit Level/Slow Shutter
	Shutter Priority	Exposure Value/Shutter Speed/Gain Limit Level
	Iris Priority	Exposure Value/Iris Level/Gain Limit Level/Slow Shutter
	Manual	Shutter Speed/Iris Level/Gain Level
	White Balance	Auto/Indoor/Outdoor/One Push/Manual
	Color Temperature	2500~10000
	Pan Tilt Zoom	Preset Speed/Digital Zoom/Digital Zoom Speed/Pan/Tilt Slow
	Noise Reduction	Off/Low/Medium/High
	Frequency	50HZ/60HZ/Auto
	Saturation	0~10
	Contrast	0~4
	Sharpness	0~3
	Mirror	Off/On
	Flip	Off/On

Video Output

Select video resolution.

Video Format	Auto	1080P/60	1080P/59.94	1080P/30
	1080P/29.97	1080I/60	1080I/59.94	720P/60
	720P/59.94	1080P/50	1080P/25	1080I/50
	720P/50			

Network

Setup IP mode – DHCP or static IP.

Network	DHCP	Off/On
	Static IP	IP Address
		Gateway
		Mask
		DNS

Advanced Setting

Advanced Setting	Audio	
	Input Type	Mic in/Line in
	Auto Gain Control	Off/On
	Noise Suppression	Off/On
	Audio Volume	0 ~ 10
	Control	
	Protocol	VISCA/Pelco D/Pelco-P/AW
	Camera Address	1~7
	Baud Rate	2400/4800/9600/38400
	Smart Framing	Off/On
	Smart Shoot	Off/On
	Number of block	2/3/4
	Initial Position	Preset 6/Preset 7/Preset 8/Preset 9
	Time to back initial position	5s/10s/15s/20s/25s/30s/35s/40s

System

Status OSD: Enable/disable Preset status (Save Preset, Call Preset, Cancel Preset) display on the screen.

Camera Selector: Set the camera ID 1~4 for using remote controller on multiple cameras control (also see [\(2\) Camera select](#) in Remote Controller chapter).

System	Camera Selector	1~4
	Status OSD	Off/On
	Language	English/日本語/繁體中文/簡體中文/한국어/Tiếng việt
	Information	Model Name/Version/IP Address/MAC
	Factory	Off/On

Web Setup

Connect the camera from a remote site through the internet.

Using the AVer IPCam Utility to Find the Camera

To find the IP address of your cameras, you can execute the IPCam Utility installer. Follow the below steps to find the IP address of the camera.

1. Download the IPCam Utility from <http://www.aver.com/download-center> .
2. Run the IPCam Utility
3. Click Search, and all available devices will be listed on the screen
4. Select a camera from the list.
5. The corresponding fields of IP address will display.
6. Double-click on the IP address of the camera from the list can connect to the camera through the browser.

[Note] If IPCam utility cannot find the camera, please check following:

1. Please make sure the Ethernet connection of camera is well connected.
2. The camera and PC (IPCam utility) are in the same LAN segment.

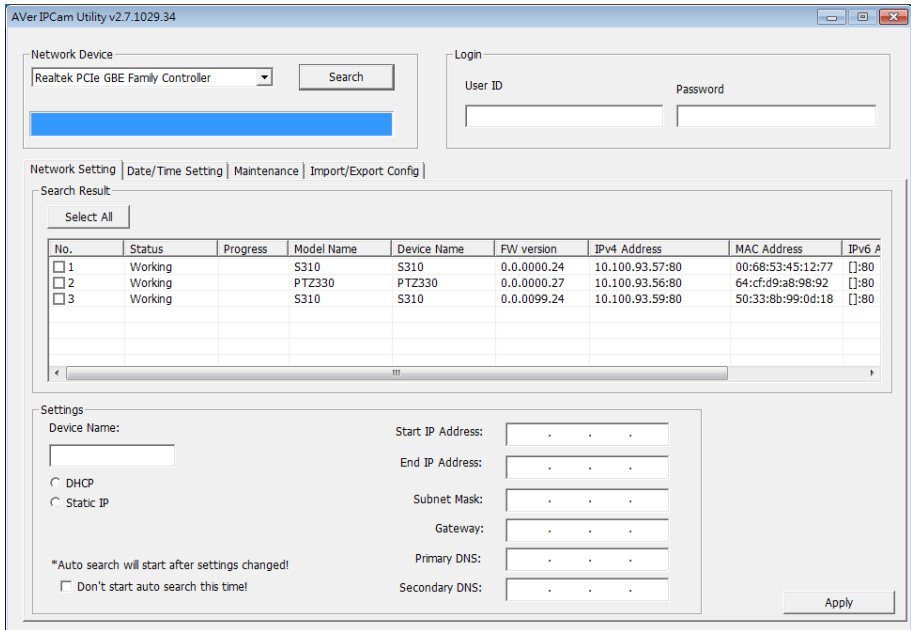

Make a Connection to the Camera via Browser

1. Find the IP address of the camera. Call out OSD menu and select “System” > “Information” Or use AVer IPCam utility to find the IP address of the camera.

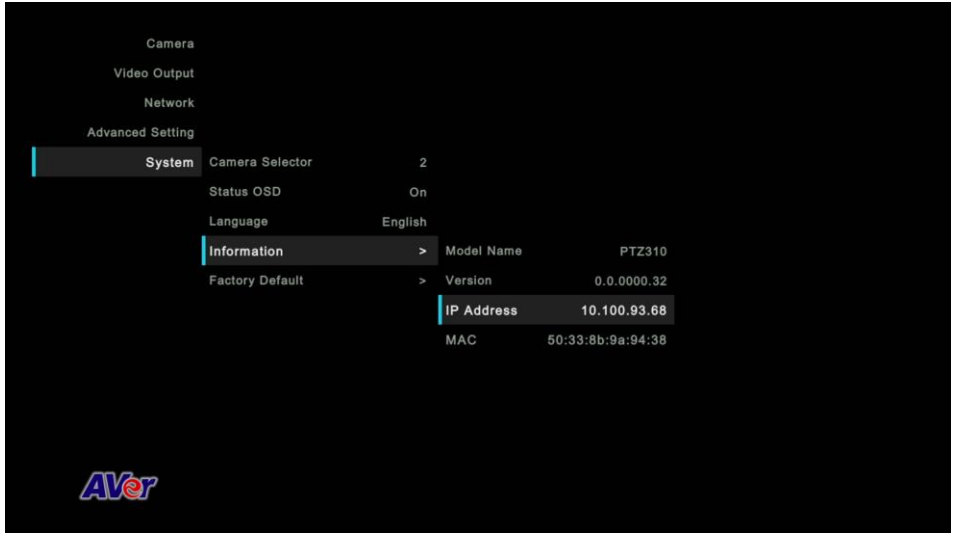

2. Open the browser and enter the IP address of the camera. The PC/laptop is required an internet access.

After connecting to the camera, the live view interface is displayed.



[Note] User can use mouse or ←, → of the keyboard to control the scroll bar on the control panel.





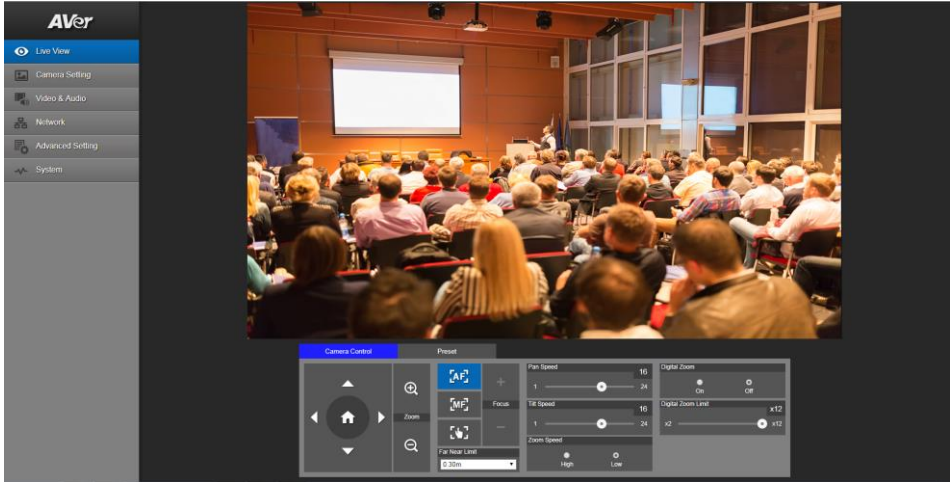

Live View

In live view, the user can setup zoom in/out, preset, focus (Auto, Manual, One push, and Focus Near Limit), the speed of zoom, pan-tilt, and preset and view preset.



Pan-Tilt-Zoom Control

To operate the PTZ Camera motion.

Use , , , and  to adjust the camera view position and use  and  to zoom. Select  to back to default position.

Digital Zoom: Enable/disable digital zoom function. Move the scroll to adjust the limit of digital zoom.

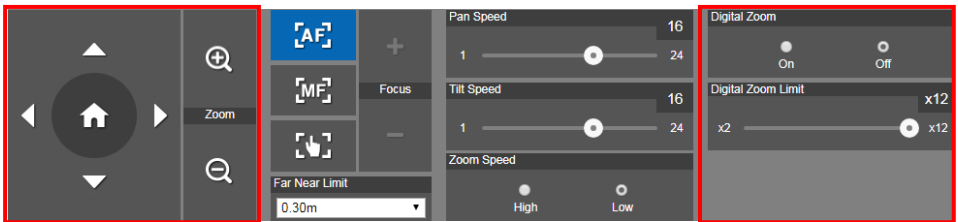

Focus

Switch to auto (AF) or manual (MF) focus. The manual focus use + and – to adjust focus. Press “+” to adjust focus to the far end and focusing on a far subject; press “-” to adjust focus to near end and focusing on a near subject.

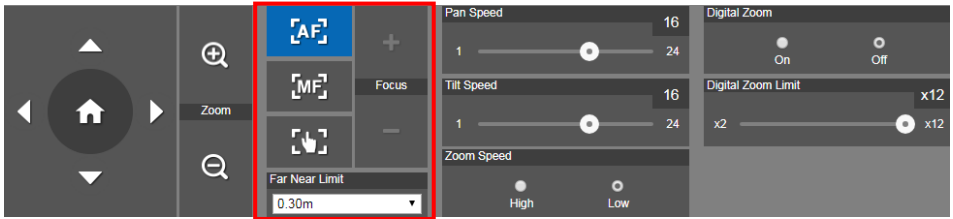

One push focus: By clicking the button to adjust Lens focus automatically once.

Focus Near Limit: Set the focus distance limit.

Manual Pan-Tile-Zoom and Preset Speed Adjustment

Adjust the speed of manual Pan-Tilt-Zoom and Preset operation. Enable/Disable the slow mode for manual pan-tilt operation. There are totally 24 levels for manual pan-tilt speed adjustment and 2 levels (Low/High) for zoom speed adjustment. There are 5 levels for preset speed adjustment.



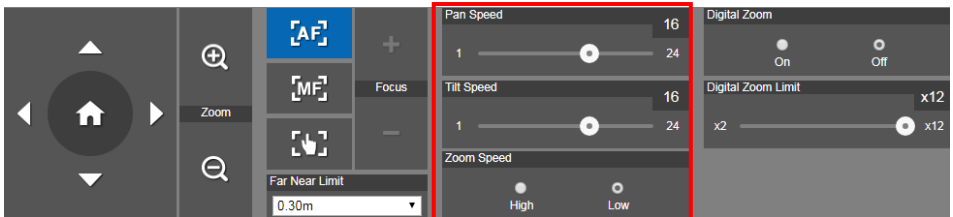

Pan/Tilt Slow: When this option is set as ON, the maximum speed of manual pan-tilt operation is 40°/sec; when this option is set as Off, the maximum speed of manual pan-tilt operation is 100°/sec.

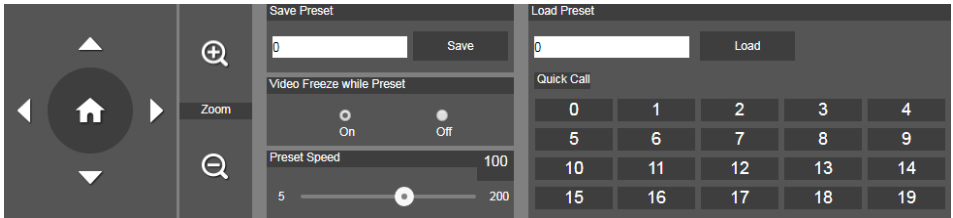

Preset

Setup preset position and view preset position.



1. Select the “Preset” tab in live view interface.
2. Use , , , and  to adjust camera view position.
3. Enter preset position number (0~255) in **Save Preset** column and select “**Save**” to save the position.
4. To call the preset position, enter a preset number (0~255) in **Load Preset** column or select the preset number (0~19) from **Quick Call** section.
5. **Preset Image Switch Freeze**: On/Off the screen view freeze function. When “**Preset Image Switch Freeze**” is on, during the preset operation, the screen will freeze until the operation is done.

Camera Settings

Exposure

Setup the exposure type -- Full auto, Iris priority, Shutter priority, or manual.

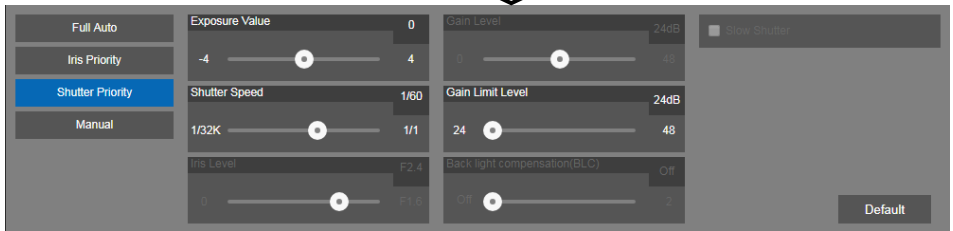
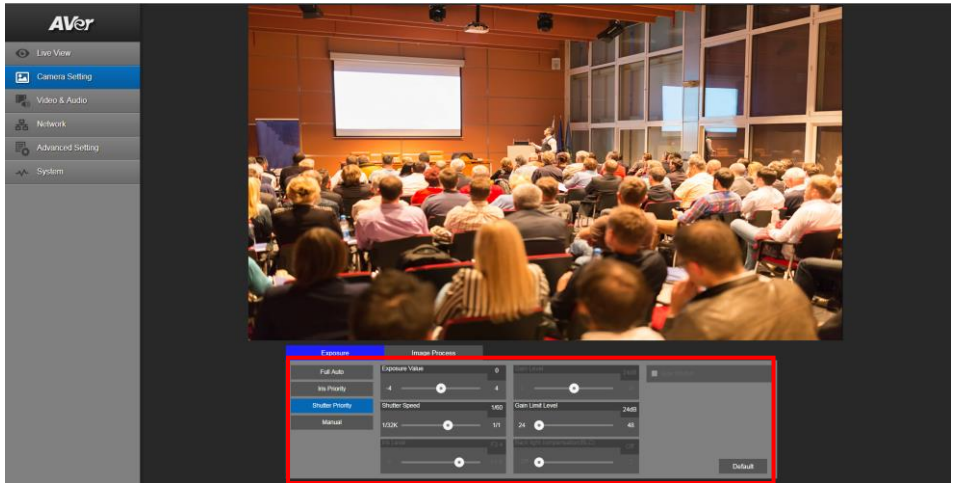
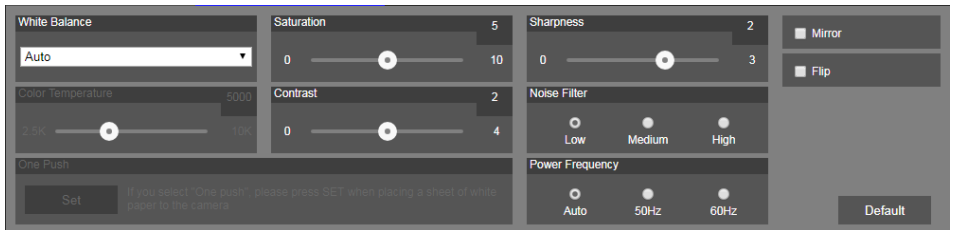

Image Process

Setup the white balance, saturation, contrast, sharpness, noise filter, power frequency, flip, and mirror. Select the "Image Process" tab in camera setting interface.



Video & Audio

The user can setup Video Mode, Video output, Framerate, Bitrate, I-VOP internal, Encode type, Rate control, Audio input type, Audio volume, and Sampling Rate.

Video mode in the stream only, the frame rate is up to 60fps and in USB+ Streaming mode is up to 30fps.

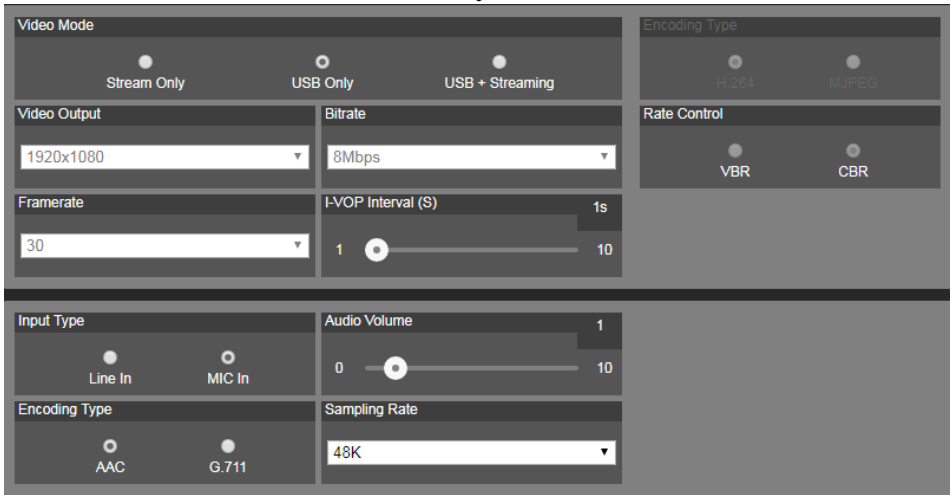
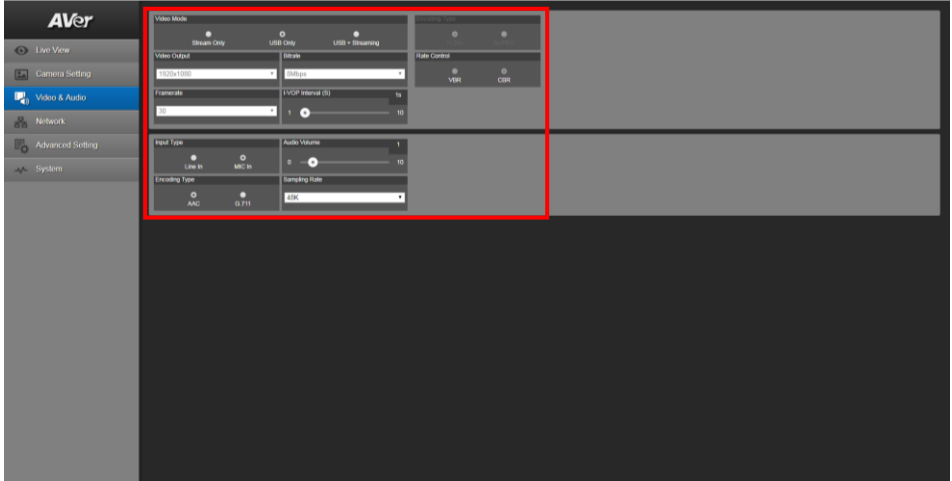

Network

Setup IP address of camera – DHCP or static IP, netmask, gateway, and DNS. After setting, select “**Confirm**” to apply settings.

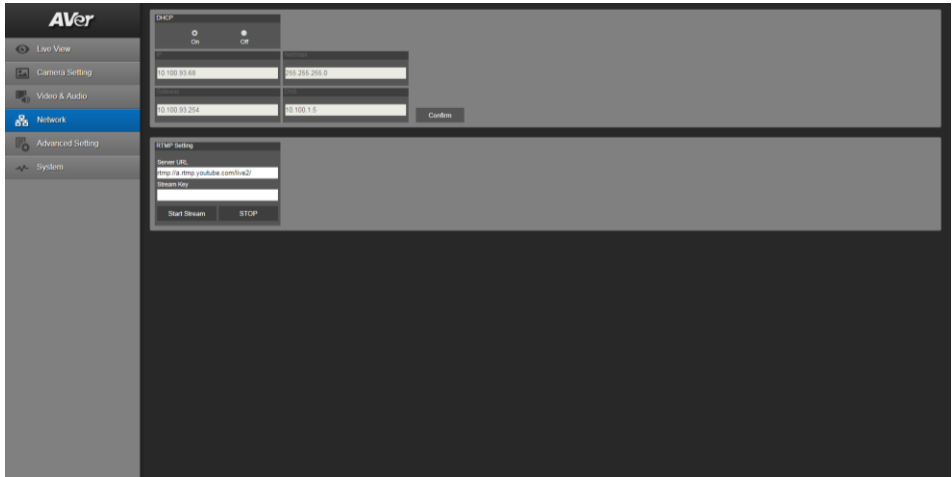

RTMP Setting

Setup for uploading the camera's live view to the broadcasting platform (ex: Youtube).

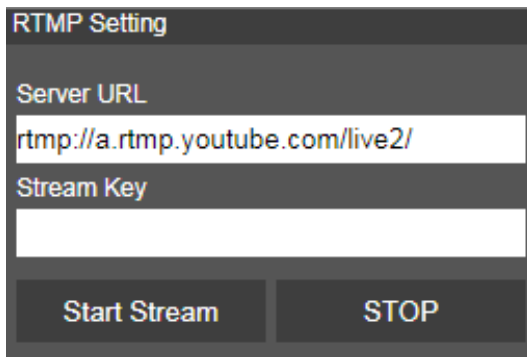

Get the RTMP server URL and stream key from the broadcasting platform and enter in “**Server URL**” and “**Stream key**” column.

Select “**Start stream**” to begin uploading the live video of the camera to the broadcasting platform.

Select “**Stop**” to stop uploading the video.

[Note] To get the RTMP server URL and stream key, please refer to the instruction of broadcasting.

Advanced Setting

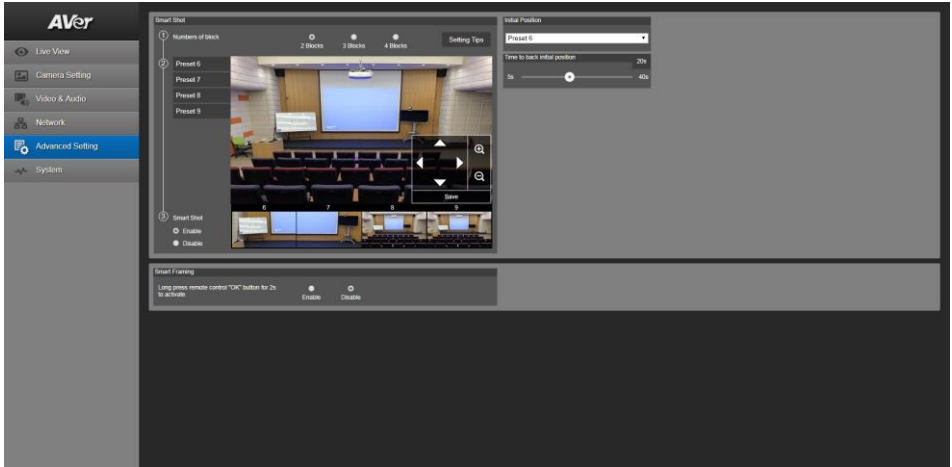

SmartShoot

Setup the block area for the camera to detect object and follow-up the object to move the camera when the object is in block area that user has set.

1. In the advanced setting interface, select the “**Number of block**” (2, 3, or 4). Each block is corresponding to one preset position. The maximum is 4 blocks (4 preset positions).

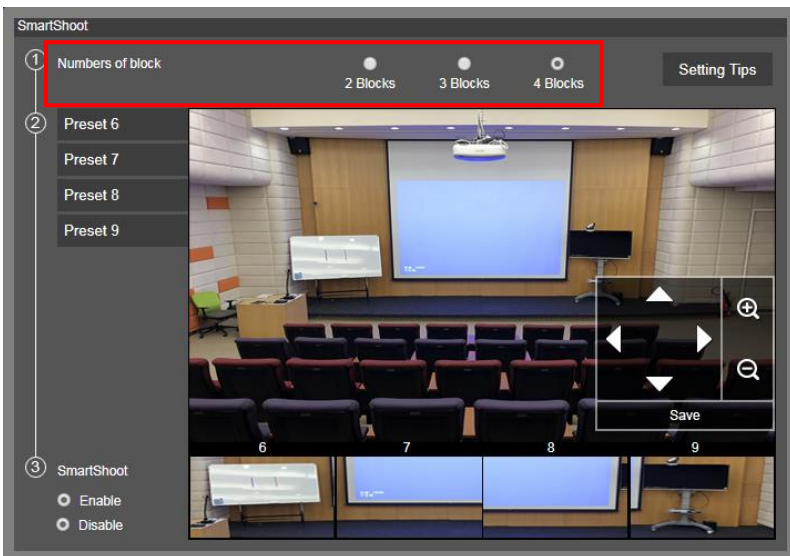

2. Set the preset positions in order (preset 6 to preset 9). Use direction control panel to move the camera to wanted position and select “save” to save the preset position. And, a snapshot of the preset image will show at corresponding image display box. Repeat the step to set another preset position.

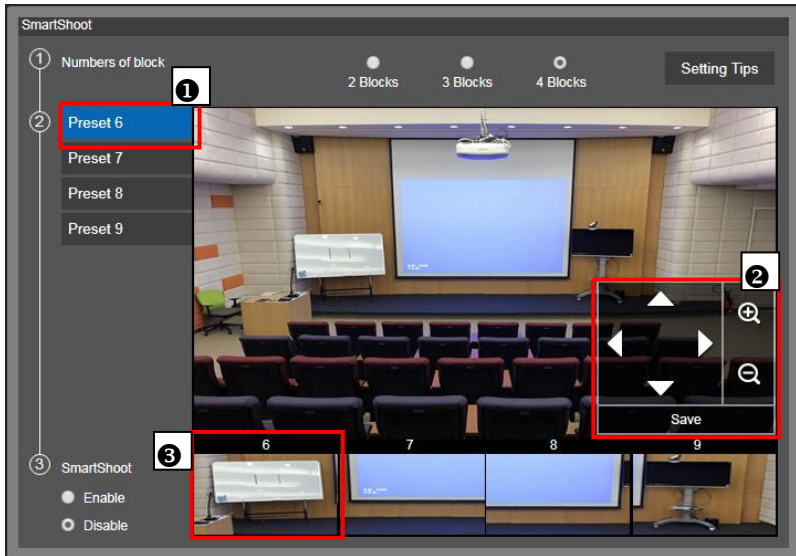

3. Set the “Initial position” and “Time to back initial position”. The camera will back to initial position is based on the time is set at Time to back initial position.

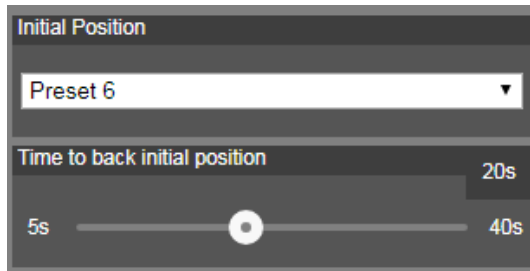

4. Select “Enable” to activate the SmartShoot function. To stop the SmartShoot function, select “Disable”.

[Note] In OSD menu, user can enable and disable SmartShoot function, too.

SmartFrame

Press  button 2 seconds on the remote controller, it will enable to auto focus the face of object and zoom in.

Select **"Enable"** to activate the function.

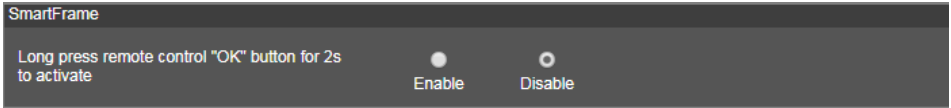

System

The system information of Camera is displayed in this page, including Model name, IP address, MAC address, and firmware version.

The user can update firmware and reset to Factory default in this page. The user can also set the OSD display output to HDMI or 3G-SDI interface.

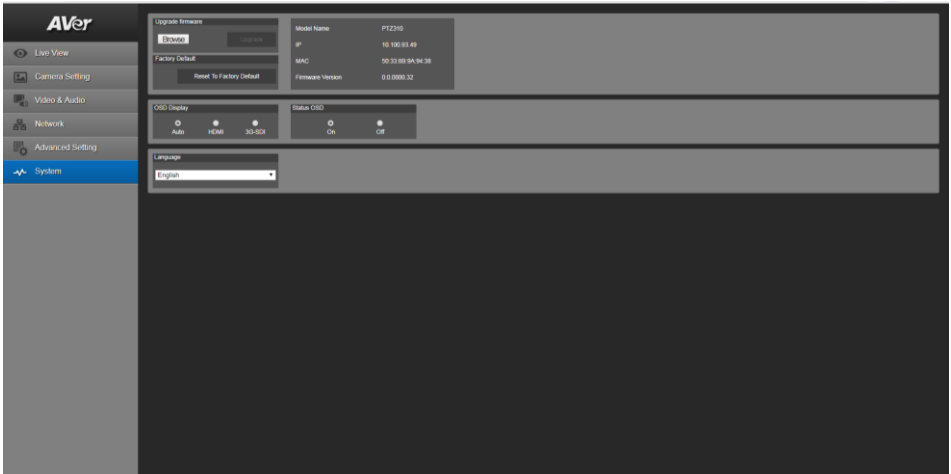

Using RTSP Connect to Camera

To use RSTP player connecting to the camera; please enter the following RTSP URL in your application such as VLC, PotPlayer or Quick Time.

["rtsp://IP address of PTZ310/330/310W/330W/live_st1"](rtsp://IP address of PTZ310/330/310W/330W/live_st1)

Firmware Update

Web Firmware Update

1. Download the newest firmware from <http://www.aver.com/download-center> .
2. Connect to the camera through the browser.
3. Select **System** > **Upgrade** firmware > **Browse**.
4. Select the firmware and select the “**Upgrade**” button.
5. After updating, refresh the browser.

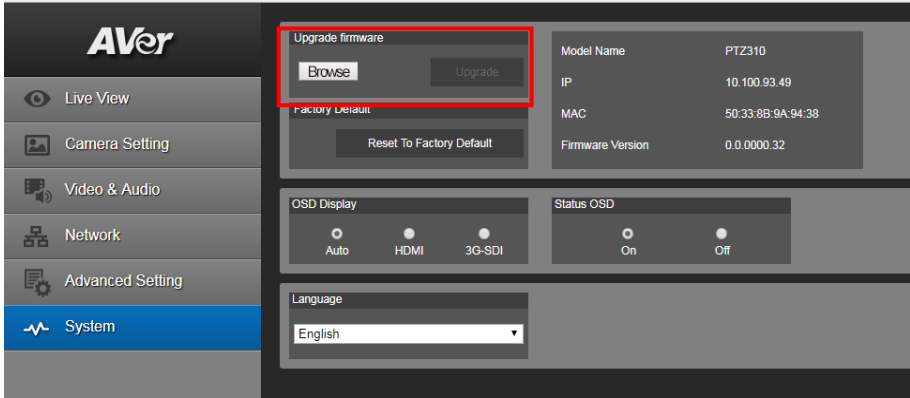

USB Update

1. Download the newest firmware and **AVer PTZApp** from <http://www.aver.com/download-center> .
2. Connect the camera to PC/Laptop through the USB port.
3. Run the AVer PTZApp.
4. Select “**Update Now**”.

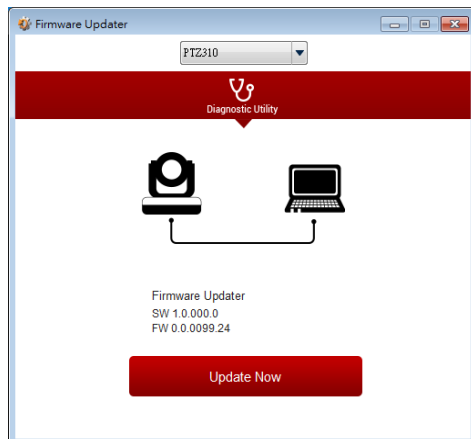

5. Select **Manual update** and locate the firmware to start the process.

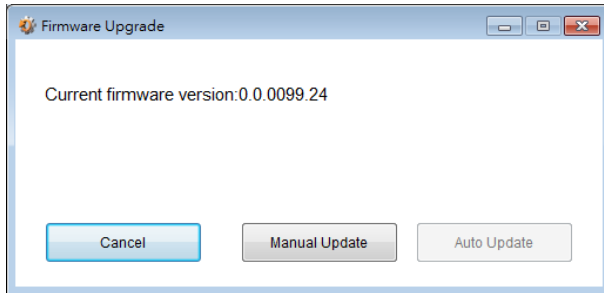

RS232 Command Table

Command Set	Command	Command Packet	Comments
AddressSet	Boardcast	88 30 01 FF	Address setting
IF_Clear	Boardcast	88 01 00 01 FF	I/F Clear
CommandCancel	-	8x 2p FF	p: Socket No. (=1or2)
CAM_Zoom	Stop	8x 01 04 07 00 FF	Zoom Control
CAM_Zoom	Tele (Standard)	8x 01 04 07 02 FF	
CAM_Zoom	Wide (Standard)	8x 01 04 07 03 FF	
CAM_Zoom	Tele (Variable)	8x 01 04 07 2p FF	p=0 (Low) to 7 (High)
CAM_Zoom	Wide (Variable)	8x 01 04 07 3p FF	
CAM_Zoom	Direct	8x 01 04 47 0p 0q 0r 0s FF	pqrs: Zoom Position
CAM_DZoom	On	8x 01 04 06 02 FF	Digital zoom ON/OFF
CAM_DZoom	Off	8x 01 04 06 03 FF	
CAM_Focus	Stop	8x 01 04 08 00 FF	Focus Control
CAM_Focus	Far (Standard)	8x 01 04 08 02 FF	
CAM_Focus	Near (Standard)	8x 01 04 08 03 FF	
CAM_Focus	Far (Variable)	8x 01 04 08 2p FF	p=0 (Low) to 7 (High)
CAM_Focus	Near (Variable)	8x 01 04 08 3p FF	
CAM_Focus	Direct	8x 01 04 48 0p 0q 0r 0s FF	pqrs: Focus Position · 0x0000(wide) ~ 0x4000(tele) ·
CAM_Focus	Auto Focus	8x 01 04 38 02 FF	AF ON/OFF
CAM_Focus	Manual Focus	8x 01 04 38 03 FF	
CAM_Focus	Auto/Manual	8x 01 04 38 10 FF	
CAM_Focus	One Push Trigger	8x 01 04 18 01 FF	One Push AF Trigger
AF_Sensitivity	Normal	8x 01 04 58 02 FF	AF Sensitivity Normal/Low
AF_Sensitivity	Low	8x 01 04 58 03 FF	
CAM_AFMMode	Normal AF	8x 01 04 57 00 FF	Continous AF
CAM_AFMMode	Zoom Trigger AF	8x 01 04 57 02 FF	Continous AF OFF, only trigger AF after zoom in/out

Command Set	Command	Command Packet	Comments
CAM_ZoomFocus	Direct	8x 01 04 47 0p 0q 0r 0s 0t 0u 0v 0w FF	pqrs: Zoom Position tuvw: Focus Position
CAM_WB	Auto	8x 01 04 35 00 FF	Normal Auto
CAM_WB	Indoor	8x 01 04 35 01 FF	Indoor mode
CAM_WB	Outdoor	8x 01 04 35 02 FF	Out door mode
CAM_WB	One Push WB	8x 01 04 35 03 FF	One Push WB mode
CAM_WB	Manual	8x 01 04 35 05 FF	Manual Control Mode
CAM_WB	One Push Trigger	8x 01 04 10 05 FF	One Push WB Trigger
CAM_AE	Full Auto	8x 01 04 39 00 FF	Automatic Exposure mode
CAM_AE	Manual	8x 01 04 39 03 FF	Manual Control mode
CAM_AE	Shutter Priority	8x 01 04 39 0A FF	Shutter priority Exposure mode
CAM_AE	Iris Priority	8x 01 04 39 0B FF	Iris priority Exposure mode
CAM_SlowShutter	Auto	8x 01 04 5A 02 FF	Auto Slow Shutter ON/OFF
CAM_Shutter	Reset	8x 01 04 0A 00 FF	Shutter Setting
CAM_Shutter	Up	8x 01 04 0A 02 FF	
CAM_Shutter	Down	8x 01 04 0A 03 FF	
CAM_Shutter	Direct	8x 01 04 4A 00 00 0p 0q FF	pq: Shutter Position
CAM_Iris	Reset	8x 01 04 0B 00 FF	Iris Setting
CAM_Iris	Up	8x 01 04 0B 02 FF	
CAM_Iris	Down	8x 01 04 0B 03 FF	
CAM_Iris	Direct	8x 01 04 4B 00 00 0p 0q FF	pq: Iris Position
CAM_Gain	Reset	8x 01 04 0C 00 FF	Gain Setting
CAM_Gain	Up	8x 01 04 0C 02 FF	
CAM_Gain	Down	8x 01 04 0C 03 FF	
CAM_Gain	Direct	8x 01 04 4C 00 00 0p 0q FF	pq: Gain Position
CAM_Gain	AE Gain Limit (Direct)	8x 01 04 2C 0p FF	p: Gain Position (4 to F)
CAM_ExpComp	Reset	8x 01 04 0E 00 FF	Exposure Compensation Amount Setting
CAM_ExpComp	Up	8x 01 04 0E 02 FF	

Command Set	Command	Command Packet	Comments
CAM_ExpComp	Down	8x 01 04 0E 03 FF	
CAM_ExpComp	Direct	8x 01 04 4E 00 00 0p 0q FF	pq: ExpComp Position
CAM_BackLight	On	8x 01 04 33 02 FF	Back Light Comp ON/OFF
CAM_BackLight	Off	8x 01 04 33 03 FF	
CAM_LR_Reverse	On	8x 01 04 61 02 FF	Mirror Image ON/OFF
CAM_LR_Reverse	Off	8x 01 04 61 03 FF	
CAM_Memory	Reset	8x 01 04 3F 00 pp FF	pp: 0x00 To 0xFF
CAM_Memory	Set	8x 01 04 3F 01 pp FF	pp: 0x00 To 0xFF pp: 0x5A => SmartFrame Enable pp: 0x5B => SmartFrame Disable pp: 0x5C => SmartFrame Trigger pp: 0x5D => SmartShoot Enable pp: 0x5F => SmartShoot Disable pp: 0x60 => Trun on OSD menu
CAM_Memory	Recall	8x 01 04 3F 02 pp FF	pp: 0x00 To 0xFF pp: 0x5A => SmartFrame Enable pp: 0x5B => SmartFrame Disable pp: 0x5C => SmartFrame Trigger pp: 0x5D => SmartShoot Enable pp: 0x5F => SmartShoot Disable pp: 0x60 => Trun on OSD menu
SYS_Menu	On	8x 01 06 06 02 FF	turn on the menu screen

Command Set	Command	Command Packet	Comments
SYS_Menu	Off	8x 01 06 06 03 FF	Erasing menu display(turn off the menu screen/VC-A70H)
SYS_Menu	On/Off	8x 01 06 06 10 FF	turn on/off the menu screen
SYS_Menu	Menu Enter	8x 01 7E 01 02 00 01 FF	menu enter
Video Format Change 4)_ (Video System Rotary Switch 7: only VISCA Control enabled)	-	8x 01 7E 01 1E 0p 0q FF	pq 00→1920 x 1080p/59.94 pq 02→1920 x 1080p/29.97 pq 03→1920 x 1080i/59.94 pq 04→1280 x 720p/59.94 pq 05→1280 x 720p/29.97 pq 08→1920 x 1080p/50 pq 0A→1920 x 1080p/25 pq 0B→1920 x 1080i/50 pq 0C→1280 x 720p/50 pq 0D→1280 x 720p/25
Pan-tiltDrive	Up	8x 01 06 01 VV WW 03 01 FF	VV: Pan speed setting 0x01 (low speed) to 0x18 (high speed) WW: Tilt speed setting 0x01 (low speed) to 0x18 (high speed) YYYYY: Pan Position EAC00 to 15400 (CENTER 00000) ZZZZZ: Tilt Position FC400 to 0B400 (Image Flip: OFF) (CENTER 00000) Tilt Position F4C00 to 03C00 (Image Flip: ON) (CENTER 00000) SRG-300H → see notes VC-A70H → see notes PT20X-SDI-GY-G2 → see notes
Pan-tiltDrive	Down	8x 01 06 01 VV WW 03 02 FF	
Pan-tiltDrive	Left	8x 01 06 01 VV WW 01 03 FF	
Pan-tiltDrive	Right	8x 01 06 01 VV WW 02 03 FF	
Pan-tiltDrive	UpLeft	8x 01 06 01 VV WW 01 01 FF	
Pan-tiltDrive	UpRight	8x 01 06 01 VV WW 02 01 FF	
Pan-tiltDrive	DownLeft	8x 01 06 01 VV WW 01 02 FF	
Pan-tiltDrive	DownRight	8x 01 06 01 VV WW 02 02 FF	
Pan-tiltDrive	Stop	8x 01 06 01 VV WW 03 03 FF	
Pan-tiltDrive	Home	8x 01 06 04 FF	
Pan-tiltDrive	Reset	8x 01 06 05 FF	
Pan-tiltSet SlowPanTilt	On	8x 01 06 44 02 FF	Pan/Tilt Slow Mode On/Off

Command Set	Command	Command Packet	Comments
Pan-tiltSet SlowPanTilt	Off	8x 01 06 44 03 FF	
Firmware	Firmware version	8x 01 02 03 FF	
Factory Reset	System Factory Reset	8x 01 04 3F 03 00 FF	
Preset Speed	Set Preset Speed	8x 01 06 20 0p FF	p: 0 to 2, 0:150/s, 1:250/s, 2: 300/s (Lumens) p:0 to 5, (AVer)

Specification

PTZ310/310W

Camera	
Image sensor	1/2.8" 1080p 60fps Exmor CMOS
Effective picture elements	Approx. 2.1 Megapixels
Output Resolution	Auto, 1080p/60, 1080p/59.94, 1080p/50, 1080i/60, 1080i/59.94, 1080i/50, 1080p/30, 1080p/29.97, 1080p/25, 720p/60, 720p/59.94, 720p/50
Minimum Illumination	0.4 lux (IRE50, F1.6, 30FPS)
S/N ratio	> 50dB
Gain	Auto/Manual
TV Line	800 (center/wide), 700 (corner/wide)
Shutter Speed	1/1 s to 1/32,000 s
Exposure Control	Auto, Manual, Priority AE(Shutter, IRIS), BLC
White balance	Auto/Indoor/Outdoor/One-push/Manual(2500 - 10000)
Optical Zoom	12X
Digital Zoom	12X
Horizontal Viewing Angle	72.5° (Wide) ~ 6.3° (Tele)
Focal length	f = 3.9 mm (Wide) ~ 46.8 mm (Tele)
Aperture (Iris)	F = 1.6 (Wide) ~ 2.8 (Tele)
Minimum working distance	Wide - 0.3 m, Tele - 1.5 m
Pan/Tilt Angle	Pan: +- 130°, Tilt: +90°/-30°
Pan/Tilt Speed (manual)	Pan: 0.1~100°/sec, Tilt: 0.1~100°/sec
Preset Speed	Pan: 200°/sec, Tilt: 200°/sec
Preset Position	10 (IR), 255 (RS232)
Camera Control - IR	Yes

Camera	
Camera Control - Interface	RS232 (DIN8) / RS422 (RJ45)
Camera Control - Protocol	VISCA/PELCO-D (RS232/RS422/IP), CGI (IP)
Image Processing	Noise Reduction (2/3D), Filp, Mirror
Power Frequency	Auto/50Hz/60Hz
Audio	
Audio - Channel	2ch (stereo)
Audio - Codec	AAC-LC (48/44.1.32.24K), G.711/PCM (16K/8K)
Audio - Sample Rate	48/44.1/32/24/16/8Khz
Interface	
Video Output	3G-SDI, HDMI, IP
Audio Output	3G-SDI, HDMI, IP
Audio Input	MIC/Line in
General	
Power Requirement	AC100V-AC240V to DC12V/5A
PoE	POE+ (IEEE 802.3at), Class 4
Operating Condition	Temperature: 0°C ~ +40°C Humidity: 20% ~80%
Storage Condition	Temperature: -20°C ~ +60°C Humidity: 20% ~ 95%
Dimensions	180mm(L) x 140mm(W) x 183.5mm(H)
Weight	1.741 kg
Application	Indoor
Security	Kensington slot
Remote Controller	Infrared
Language	English / Japanese / Traditional Chinese
Accessory	Remote control, 12V/5A power adapter;

IP Streaming	
Resolution	1920x1080, 1280x720, 960x540, 640x480
Network Video Compress Format	H.264 (High Profile), MJPEG
Maximum Frame Rate	H.264: 60fps (1920x1080), MJPEG: 30fps (1920x1080)
Bit-rate Control Mode	VBR/CBR (selectable)
Range of Bit-rate setting	512Kbps ~ 32Mbps
Network Interface	10/100/1000Base-T
Multi-stream Capability	2
Network Protocol	IPv4, TCP, UDP, ARP, ICMP, IGMP, HTTP, DHCP, RTP/RTCP, RTSP, VISCA over IP
WebUI	
Live Video Preview	Yes
Camera PTZ Control	Pan / Tilt / Zoom / Focus / Preset Control
Camera/Image Adjustment	Exposure/WhiteBalance/Picture
Network Configuration	DHCP / IP Addr / Gateway / Netmask / DNS
Software Tools	
Device IP Searching, Configuration tool	Windows Application

PTZ330/330W

Camera	
Image sensor	1/2.8" 1080p 60fps Exmor CMOS
Effective picture elements	Approx. 2.1 Megapixels
Output Resolution	Auto, 1080p/60, 1080p/59.94, 1080p/50, 1080i/60, 1080i/59.94, 1080i/50, 1080p/30, 1080p/29.97, 1080p/25, 720p/60, 720p/59.94, 720p/50
Minimum Illumination	0.3 lux (IRE50, F1.6, 30FPS)
S/N ratio	> 50dB
Gain	Auto/Manual
TV Line	800 (center/wide), 600 (corner/wide)
Shutter Speed	1/1 s to 1/32,000 s
Exposure Control	Auto, Manual, Priority AE(Shutter, IRIS), BLC
White balance	Auto/Indoor/Outdoor/One-push/Manual(2500 - 10000)
Optical Zoom	30X
Digital Zoom	12X
Horizontal Viewing Angle	67° (Wide) ~ 6.3° (Tele)
Focal length	f = 4.3 mm (Wide) ~ 129 mm (Tele)
Aperture (Iris)	F = 1.6 (wide) ~ 4.7 (Tele)
Minimum working distance	Wide - 0.1 m, Tele - 1.2 m
Pan/Tilt Angle	Pan: +- 130°, Tilt: +90°/-30°
Pan/Tilt Speed (manual)	Pan: 0.1~100°/sec, Tilt: 0.1~100°/sec
Preset Speed	Pan: 200°/sec, Tilt: 200°/sec
Preset Position	10 (IR), 255 (RS232)
Camera Control - IR	Yes
Camera Control - Interface	RS232 (DIN8) / RS422 (RJ45)

Camera	
Camera Control - Protocol	VISCA/PELCO-D (RS232/RS422/IP), CGI (IP)
Image Processing	Noise Reduction (2/3D), Filp, Mirror
Power Frequency	Auto/50Hz/60Hz
Audio	
Audio - Channel	2ch (stereo)
Audio - Codec	AAC-LC (48/44.1.32.24K), G.711/PCM (16K/8K)
Audio - Sample Rate	48/44.1/32/24/16/8KHz
Interface	
Video Output	3G-SDI, HDMI, IP
Audio Output	3G-SDI, HDMI, IP
Audio Input	MIC/Line in
General	
Power Requirement	AC100V-AC240V to DC12V/5A
PoE	POE+ (IEEE 802.3at), Class 4
Operating Condition	Temperature: 0°C ~ +40°C Humidity: 20% ~80%
Storage Condition	Temperature: -20°C ~ +60°C Humidity: 20% ~ 95%
Dimensions	180 mm(L) x 140mm(W) x183.5mm(H)
Weight	1.62 kg
Application	Indoor
Security	Kensington slot
Remote Controller	Infrared
Language	English / Japanese / Traditional Chinese
Accessory	Remote control, 12V/5A power adapter;

IP Streaming	
Resolution	1920x1080, 1280x720, 960x540, 640x480
Network Video Compress Format	H.264 (High Profile), MJPEG
Maximum Frame Rate	H.264: 60fps (1920x1080), MJPEG: 30fps (1920x1080)
Bit-rate Control Mode	VBR/CBR (selectable)
Range of Bit-rate setting	512Kbps ~ 32Mbps
Network Interface	10/100/1000Base-T
Multi-stream Capability	2
Network Protocol	IPv4, TCP, UDP, ARP, ICMP, IGMP, HTTP, DHCP, RTP/RTCP, RTSP, VISCA over IP
WebUI	
Live Video Preview	Yes
Camera PTZ Control	Pan / Tilt / Zoom / Focus / Preset Control
Camera/Image Adjustment	Exposure/WhiteBalance/Picture
Network Configuration	DHCP / IP Addr / Gateway / Netmask / DNS
Software Tools	
Device IP Searching, Configuration tool	Windows Application