

# CAM520 Pro2

## User Manual



## **Federal Communications Commission Statement**

NOTE: This equipment has been tested and found to comply with the limits for a Class A digital device, pursuant to part 15 of the FCC Rules. These limits are designed to provide reasonable protection against harmful interference when the equipment is operated in a commercial environment. This equipment generates, uses, and can radiate radiofrequency energy and, if not installed and used in accordance with the instruction manual, may cause harmful interference to radio communications. Operation of this equipment in a residential area is likely to cause harmful interference in which case the user will be required to correct the interference at his own expense.

FCC Caution: Any changes or modifications not expressly approved by the party responsible for compliance could void the user's authority to operate this equipment.

This device complies with part 15 of the FCC Rules.

Operation is subject to the following two conditions:

- (1) This device may not cause harmful interference, and
- (2) this device must accept any interference received, including interference that may cause undesired operation.

### **Warning:**

This is a class A product. In a domestic environment this product may cause radio interference in which case the user may be required to take adequate measures.

This Class A digital apparatus complies with Canadian ICES-003. Cet appareil numérique de la classe A est conforme à la norme NMB-003 du Canada.

## **DISCLAIMER**

No warranty or representation, either expressed or implied, is made with respect to the contents of this documentation, its quality, performance, merchantability, or fitness for a particular purpose. Information presented in this documentation has been carefully checked for reliability; however, no responsibility is assumed for inaccuracies. The information contained in this documentation is subject to change without notice.

In no event will AVer Information Inc. be liable for direct, indirect, special, incidental, or consequential damages arising out of the use or inability to use this product or documentation, even if advised of the possibility of such damages.

## **TRADEMARKS**

"AVer" is a trademark owned by AVer Information Inc. Other trademarks used herein for description purpose only belong to each of their companies.

## **COPYRIGHT**

©2021 AVer Information Inc. All rights reserved.

All rights of this object belong to AVer Information Inc. Reproduced or transmitted in any form or by any means without the prior written permission of AVer Information Inc. is prohibited. All information or specifications are subject to change without prior notice.

## **NOTICE**

SPECIFICATIONS ARE SUBJECT TO CHANGE WITHOUT PRIOR NOTICE. THE INFORMATION CONTAINED HEREIN IS TO BE CONSIDERED FOR REFERENCE ONLY.

## **WARNING**

- To reduce risk of fire or electric shock, do not expose this appliance to rain or moisture. Warranty will be void if any unauthorized modifications are done to the product.
- Do not drop the camera or subject it to physical shock.
- Use correct power supply voltage to avoid damaging camera.
- Do not place the camera where the cord can be stepped on as this may result in fraying or damage to the lead or the plug.
- Hold the bottom of the camera with both hands to move the camera. Do not grab the lens or lens holder to move the camera.

### **Remote Control Battery Safety Information**

- Store batteries in a cool and dry place.
- Do not throw away used batteries in the trash. Properly dispose of used batteries through specially approved disposal methods.
- Remove the batteries if they are not in use for long periods of time. Battery leakage and corrosion can damage the remote control. Dispose of batteries safely and through approved disposal methods.
- Do not use old batteries with new batteries.
- Do not mix and use different types of batteries: alkaline, standard (carbon-zinc) or rechargeable (nickel-cadmium).
- Do not dispose of batteries in a fire.
- Do not attempt to short-circuit the battery terminals.

## **CAUTION**

- Risk of explosion if battery is replaced by an incorrect type.
- Dispose of used batteries in a safe and proper manner.

## MORE HELP

For FAQs, technical support, software and user manual download, please visit:

**Global:** <https://www.aver.com/download-center>

**USA:** <https://www.averusa.com/business/support/>

**Europe:** <https://www.avereurope.com/download-center/>

Technical Support:

**Global:** <https://www.aver.com/technical-support>

**USA:** <https://averusa.force.com/support/s/contactsupport>

**Europe:** <https://www.avereurope.com/technical-support/>

## CONTACT INFORMATION

### Global

AVer Information Inc.  
<https://www.aver.com>  
8F, No.157, Da-An Rd.,  
Tucheng Dist.,  
New Taipei City 23673,  
Taiwan  
Tel: +886 (2) 2269 8535

### USA

AVer Information Inc.  
<https://www.averusa.com>  
668 Mission Ct.,  
Fremont, CA 94539, USA  
Tel: +1 (408) 263 3828  
Toll-free: +1 (877) 528 7824  
Technical support:  
[support.usa@aver.com](mailto:support.usa@aver.com)

### European Headquarters

AVer Information Europe B.V.  
<https://www.avereurope.com>  
Westblaak 140, 3012KM,  
Rotterdam, Netherlands  
Tel: +31 (0) 10 7600 550  
Technical support:  
[eu.rma@aver.com](mailto:eu.rma@aver.com)

# Contents

Package Contents.....	1
Product Introduction.....	2
Overview .....	2
LED Indicator.....	2
Remote Control .....	3
Pan and Tilt Angle .....	6
Installation.....	7
Device Connection .....	7
Power Connection.....	8
RS232 Connection .....	9
Wall Mount Installation .....	15
Ceiling Mount Installation (Optional).....	18
Secure the Cables.....	20
Operating the Camera .....	21
Make a Video Call .....	21
Make a Connection through the Browser .....	21
Web Settings .....	24



First Time Login.....	24
Live Screen Operation .....	25
Set Up the Preset.....	26
User can set 10 preset positions.....	26
Select the Preset Position .....	27
Camera Settings.....	27
Tracking Mode .....	28
Framing Speed .....	29
Smart Frame Preset Point.....	30
Auto Focus .....	30
Camera Focus .....	30
Home Position .....	31
Sleep Position.....	31
Sleep Timer .....	31
On Screen Menu .....	31
Camera Binding.....	31
Save Preset .....	32
Image Settings .....	32
Image Flip.....	32

Image Mirror .....	32
True WDR.....	32
Frequency.....	33
White Balance .....	33
Noise Reduction .....	33
Brightness.....	33
Saturation .....	34
RS232 Settings.....	34
Video Format Settings.....	35
H.264 Profile .....	35
IP Stream Resolution.....	35
Frame Rate.....	35
Bit Rate .....	36
RTSP .....	36
RTMP.....	37
Network Settings .....	38
DHCP.....	38
Static IP .....	39
System Settings .....	40

Language.....	40
Firmware Update .....	40
Factory Default .....	41
Camera Reboot .....	41
Change Password .....	42
SSL Certificate.....	43
Date Format.....	43
Time Format .....	43
Time Correction Mode .....	44
Information.....	45
PTZApp 2.....	46
Install PTZApp 2.....	46
Use PTZApp 2 with USB Devices .....	46
Use PTZApp 2 with a Virtual Stream .....	54
EZLive .....	56
Use AVer EZLive .....	56

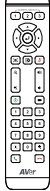

# Package Contents

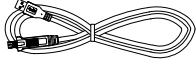
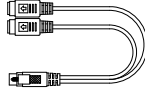
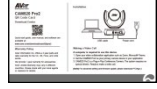
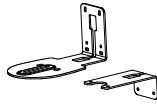
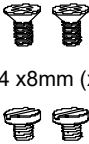
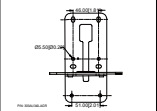
<p><b>Camera Unit</b></p>	<p><b>Remote Control</b></p>	<p><b>Power Adapter &amp; Power Plug*</b></p>	<p><b>USB 2.0 Type-B to Type-A Cable (5m)</b></p>
			
<p><b>Mini DIN9 to Mini DIN8 RS232 Adapter Cable</b></p>	<p><b>QR Code Card</b></p>	<p><b>L-Mount Brackets</b></p>	<p><b>Screws for Mount</b></p>
			 <p>M4 x8mm (x2)</p> <p>1/4\"-20 L=7.5mm (x2)</p>
<p><b>Drilling Paper</b></p>			
			

\* The power plug will vary depending on the standard power outlet of the country where it is sold.

# Product Introduction

## Overview

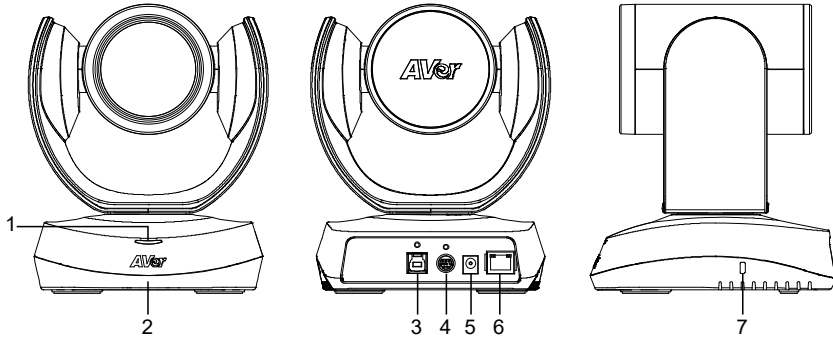

- |   |                     |   |                   |   |                 |
|---|---------------------|---|-------------------|---|-----------------|
| 1 | Status LED          | 4 | RS232 In/Out Port | 7 | Kensington Lock |
| 2 | IR Sensor           | 5 | DC 12V Power Plug |   |                 |
| 3 | USB 3.1 Type B Port | 6 | PoE Port*         |   |                 |

\* Power over Ethernet (PoE), compatible with IEEE 802.3AT and 802.3AF. Please use CAT 5e FTP cable (not included.)

## LED Indicator

<b>Power on:</b> Blink blue once
<b>Start-up:</b> Solid red
<b>Video mute:</b> Solid orange
<b>Video on:</b> Solid blue

# Remote Control

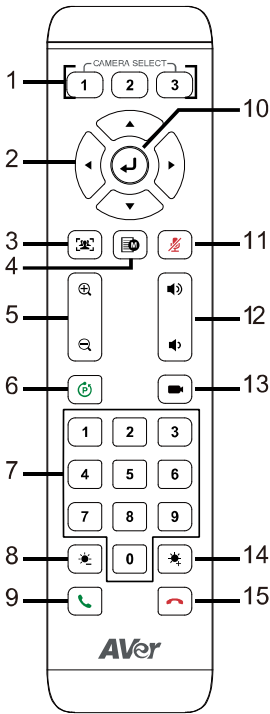

Name	Function
<p>1. Camera Select</p>	<p>One remote can control up to 3 AVer VC/CAM/VB series cameras. You can use AVer PTZApp 2 to set numbers associated with each camera, and then select which camera you would like to control using the remote.</p> <p><b>[Note]</b> If you only have one camera and do not need to adjust any setting, the default is camera 1. If you press camera 2 or 3 on the remote control, you will find your remote can't control your camera. In this case, please press camera 1 on your remote again.</p>
<p>2. Camera Directional Control</p>	<p>Use the directional buttons on the remote to control the direction of the camera. Press the directional button to move the camera or press and hold to continuously pan or tilt.</p>
<p>3. SmartFrame</p>	<p>One-click automatic FOV adjustment to fit all participants.</p> <p>Press for 1 second to switch the SmartFrame function among Manual Framing/Auto Framing/Preset Framing modes. A message (as figures shown) will display on the screen to indicate the mode.</p> <div style="display: flex; justify-content: space-around; align-items: center;"> <div style="background-color: black; color: white; padding: 5px 10px; border: 1px solid black;">Manual Framing</div> <div style="background-color: black; color: white; padding: 5px 10px; border: 1px solid black;">Auto Framing</div> </div> <div style="background-color: black; color: white; padding: 5px 10px; border: 1px solid black; margin-top: 5px;">Preset Framing</div> <p><b>[Notes]</b></p> <ul style="list-style-type: none"> <li>SmartFrame deploys face and body detection technology. People wearing masks and side facial profiles can still be detected. The maximum detection distance is 7~10 meters.</li> </ul>

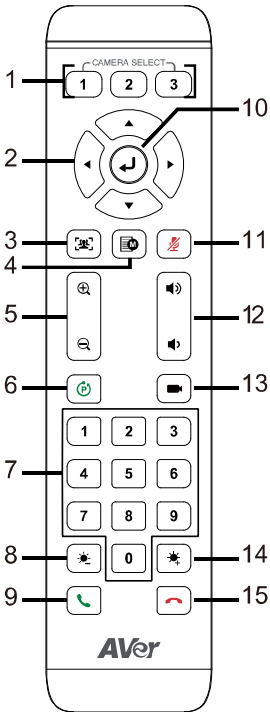

---

4. OSD Menu

- Camera will track people while moving. It will start to focus and zoom in once people stop moving for 1~5 seconds, depending on the framing speed you choose. The default framing speed is "Middle" speed. "High" speed is more suitable for one person tracking.

- Preset Framing: Set up preset points in advance (Only for Preset points 1~9. Preset 0 is for home position). Camera tracks one presenter and shoots the preset areas instead of focusing and zooming into presenter.

---

To pull up OSD menu while using HDMI out function. Not supported for CAM520 Pro2.

---

5. Zoom In/Out

Increase/Decrease the camera zoom.

---

6. Preset

The Preset button on the remote serves 2 functions.

**To Save a Preset** – Move camera to desired position. Press and hold the preset button until you receive the save message on the screen. Select preset position button 0-9 to store the current camera position. Repeat steps if needed.

**To Load a Preset** - Press the preset button and preset position button 0-9 to load a saved camera position. Repeat steps if needed.

---

7. Preset Position/Number Buttons

Preset position buttons are used in conjunction with the Preset button to save positions. There are a total of 10 presets.

Press the preset button first and then press 0~9 for the camera to move to

---

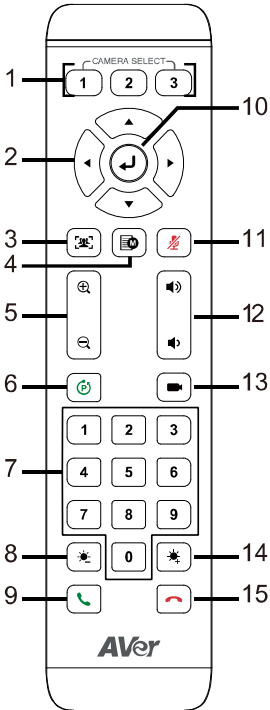

the saved position.

**[Notes]**

- Press and hold the number button “1” for 1 second to turn on or off the WDR function.
- Press and hold the number button “5” for 1 second to turn on or off the SmartFrame function.
- Press and hold the number button “8” for 1 second to enable or disable RTMP streaming function.
- Press and hold the number button “9” for 1 second to force camera to enter sleep mode. This will end any video streaming. To wake up the camera, press the button or any directional button for 1 second. This mode is not functional while USB streaming is on.

8. Brightness -	Decrease the brightness.
9. Call/Answer	Answer a call or start a call.
10. Enter	To confirm selection. Not supported for CAM520 Pro2.
11. Mute/Un-mute Speakerphone	Mute/Un-mute the speakerphone. Not supported for CAM520 Pro2.
12. Volume Up/Down	Adjust volume up or down. Not supported for CAM520 Pro2.
13. Preset Hot Key	Press to move the camera to the preset position the user has set.
14. Brightness +	Increase the brightness.
15. Hang Up	End the call.

# Pan and Tilt Angle

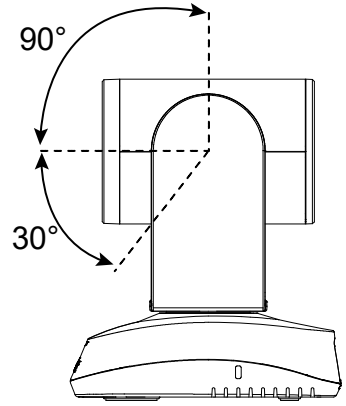
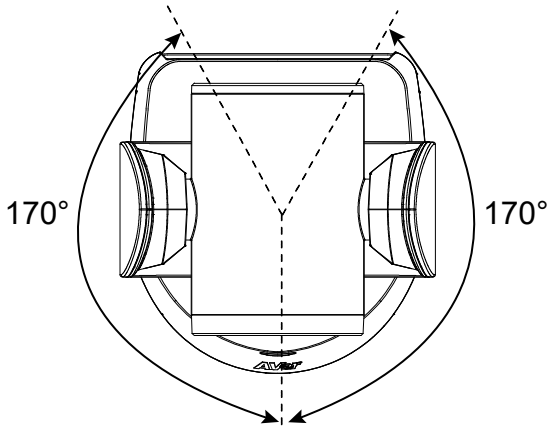

# Installation

## Device Connection

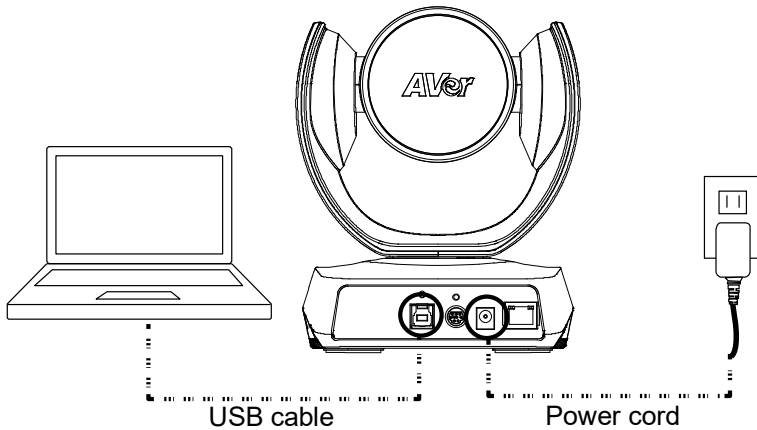

1. Use USB cable to connect the CAM520 Pro2 to your PC/laptop (refer to diagram above).
2. Connect the power to the CAM520 Pro2; power indicator will light up and camera head will rotate.
3. Install PTZApp 2 on laptop or PC that is connected with CAM520 Pro2. The app can be used to adjust and setup the parameters of the camera (refer to the section of PTZApp 2).
4. To make a call, run your video application (Zoom, Microsoft® Teams, Skype for Business, Skype, Google Meet, Intel® Unite™, RingCentral, BlueJeans, V-Cube, LiveOn, CyberLink U Meeting®, TrueConf, Adobe Connect, Cisco WebEx®, Fuze, GoToMeeting™, Microsoft® Lync™, Vidyo, vMix, WebRTC, Wirecast, XSplit, etc.). Select CAM520 Pro2 as your video device.

### [Notes]

- Use the USB 2.0 cable included in the package.
- CAM520 Pro2 has the USB 3.1 port which is USB 2.0 compatible.

Maximum resolution/fps for USB 2.0 and USB 3.1 port are shown below.

	M-JPEG/ fps	NV12/fps	YUV/fps
USB 2.0	1080@ 60 fps	720p@ 10 fps 480p@ 30 fps	720p@ 10 fps 480p@ 30 fps
USB 3.1	1080@ 60 fps	1080p@ 30 fps	1080p@ 30 fps

# Power Connection

The power supply can be plugged into the wall outlet or drawn from PoE switch (Ethernet).

## Wall outlet

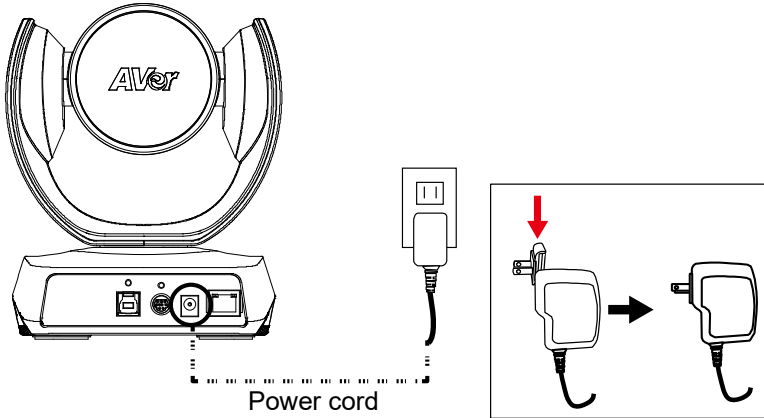

## PoE

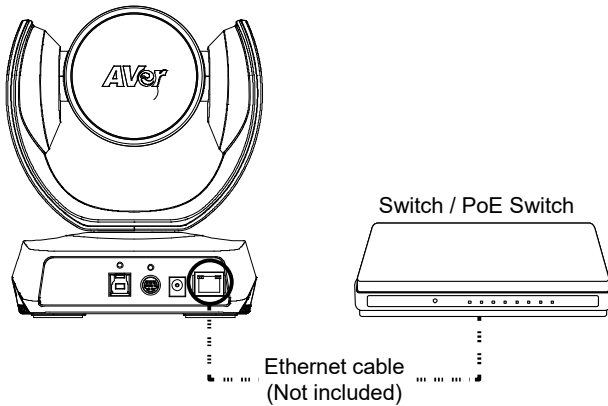

**[Note]** To ensure stability of IP video streaming, please use CAT 5e FTP cable (not included).



# RS232 Connection

## ■ Camera RS232 Port Pin Definition

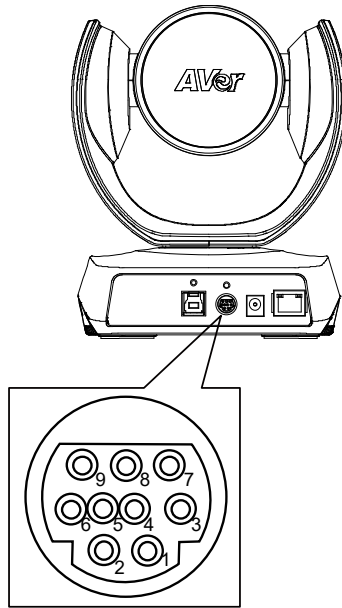

Function	Mini DIN9 PIN #	I/O Type	Signal	Description
VISCA IN	1	Output	DTR	Data Terminal Ready
	2	Input	DSR	Data Set Ready
	3	Output	TXD	Transmit Data
	6	Input	RXD	Receiver Data
VISCA OUT	7	Output	DTR	Data Terminal Ready
	4	Input	DSR	Data Set Ready
	8	Output	TXD	Transmit Data
	9	Input	RXD	Receiver Data
	5	---	---	Not connect

## ■ Computer/Keyboard Controller and Camera Connection

### Direct Connection

If users do not use AVer RS232 adapter cable, please refer to the pin connection shown below.

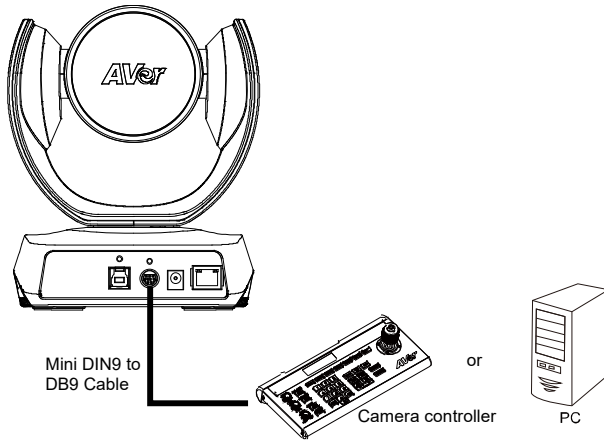

Camera (Mini DIN9)	Camera controller or PC (DB9)
1. DTR (IN)	1. DCD
2. DSR (IN)	2. RXD
3. TXD (IN)	3. TXD
6. RXD (IN)	4. DTR
7. DTR (OUT)	5. GND
4. DSR (OUT)	6. DSR
8. TXD (OUT)	7. RTS
9. RXD (OUT)	8. CTX
	9. RI

**Use the supplied RS232 mini DIN9 to mini DIN8 cable**

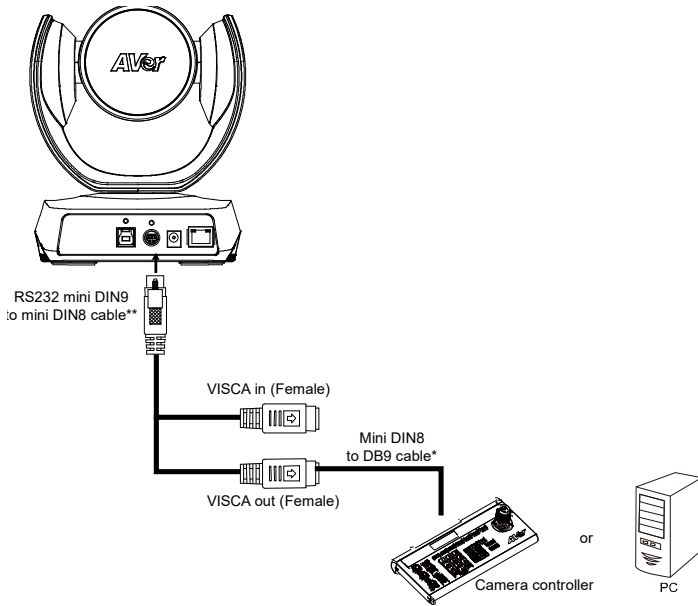

Camera controller or PC  
(DB9)

1. DCD
2. RXD
3. TXD
4. DTR
5. GND
6. DSR
7. RTS
8. CTX
9. RI

Camera  
(Mini DIN8)

1. DTR (IN)
2. DSR (IN)
3. TXD (IN)
4. GND (IN)
5. RXD (IN)
6. GND (IN)

1. DTR (OUT)
2. DSR (OUT)
3. TXD (OUT)
4. GND (OUT)
5. RXD (OUT)
6. GND (OUT)

\* Mini DIN8 to D-Sub9 (DB9) cable 064AOTHERBPK is an optional item.

\*\* RS232 mini DIN9 to mini DIN8 Cable Pin Definition

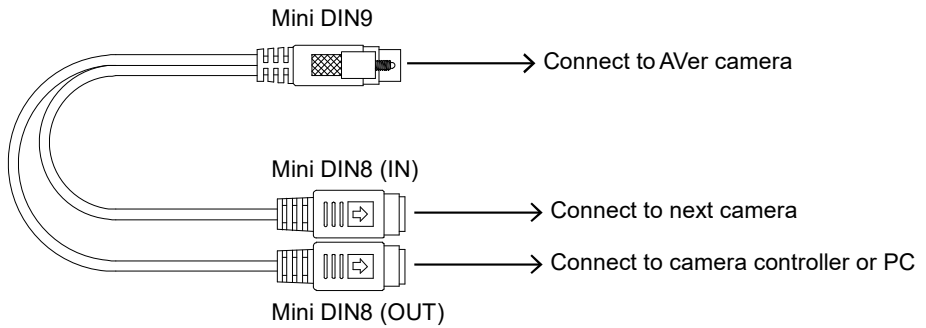

**Mini DIN8 Pin Definition**

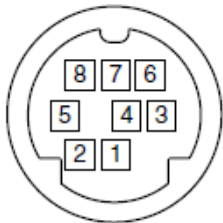

No.	Pin
1	DTR
2	DSR
3	TXD
4	GND
5	RXD
6	GND
7	NC
8	NC

## ■ Camera Cascade Connection

### Direct Connection

If users do not use AVer RS232 adapter cable, please refer to the pin connection shown below for cascading cameras.

Total can connect up to 7 cameras.

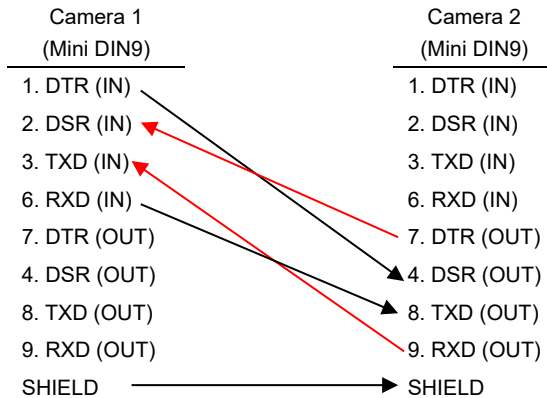
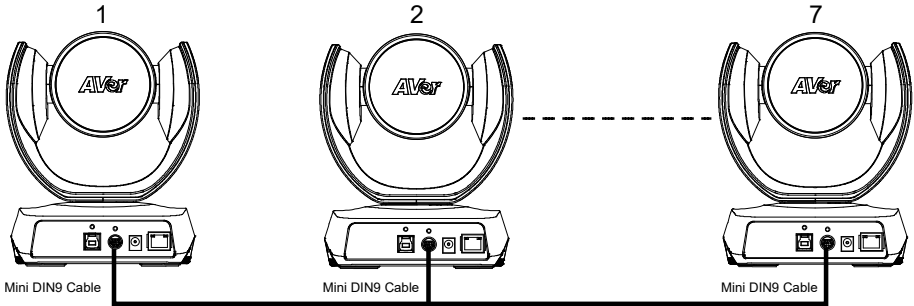

**Use the RS232 mini DIN9 to mini DIN8 cable**

Total can connect up to 7 cameras.

To facilitate the camera cascade, users can use AVer RS232 adapter cable.

Connect camera with AVer mini DIN9 to mini DIN8 adapter cable. Connect the mini DIN8 female side to male mini DIN8 Visca cable (Users have to buy it in the market) and then connect AVer mini DIN9 to mini DIN8 adapter cable again to connect to next camera.

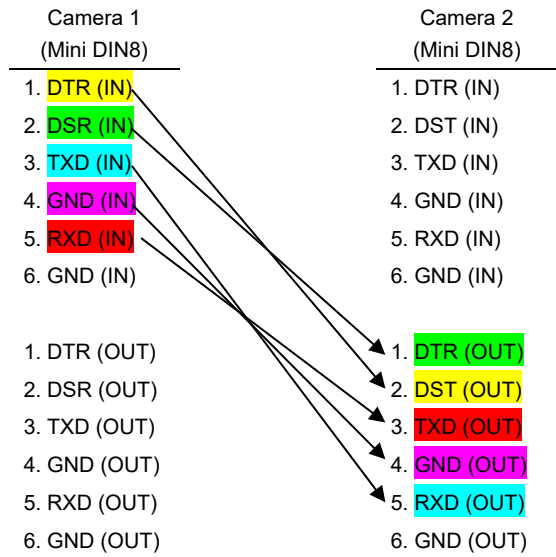
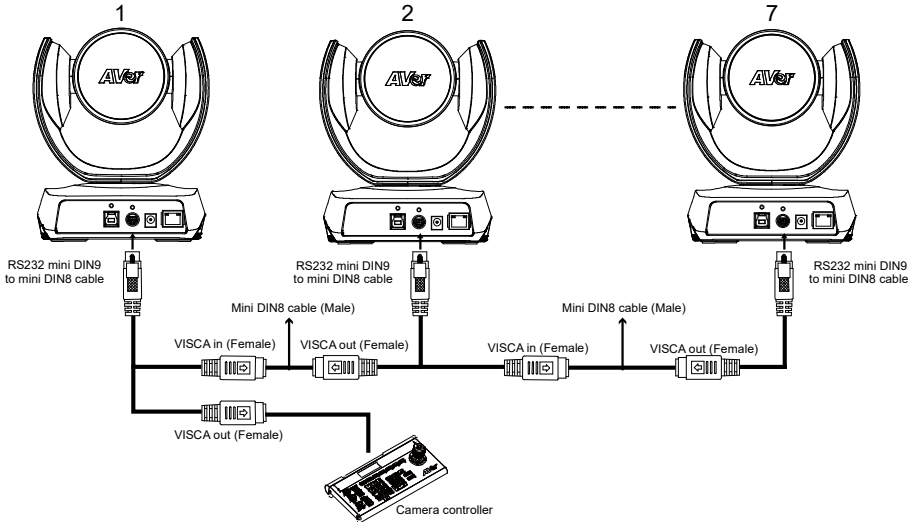

## Wall Mount Installation

1. Use the drilling paper included in the package to drill the holes in the wall where the user wants to mount the camera.

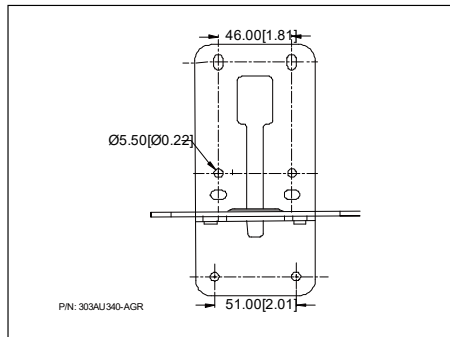

2. Use the screws (not included) to secure the L-mount bracket **A** on the wall.

### Screw

**For Cement wall:** M4 x20mm self-tapping screws (x4) + Plastic conical anchor

**For Wooden wall:** M4 x20mm self-tapping screws (x4)

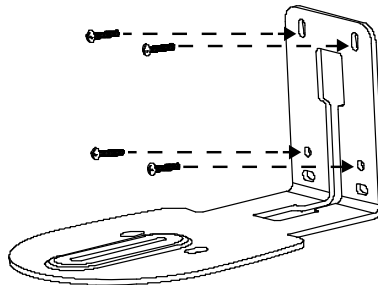

3. Then, assemble the L-mount brackets **A** + **B** with screws (included in package).

**Screw size:**  M4 x8mm (x2)

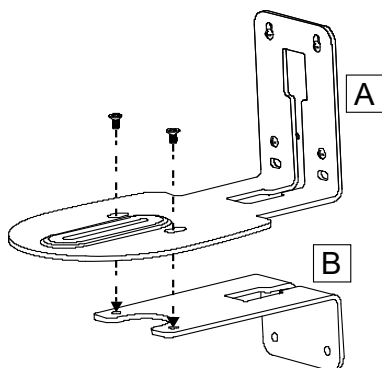

4. After assembling the L-mount brackets, use the screws (not included) to secure the lower part of L-mount brackets on the wall.

**Screw**

**For Cement wall:** M4 x20mm self-tapping screws (x2) + Plastic conical anchor

**For Wooden wall:** M4 x20mm self-tapping screws (x2)

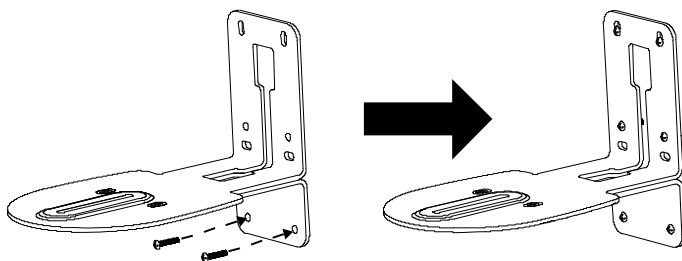



5. Pass the cables through the hole on the L-mount bracket and connect the cables to corresponding connection ports.

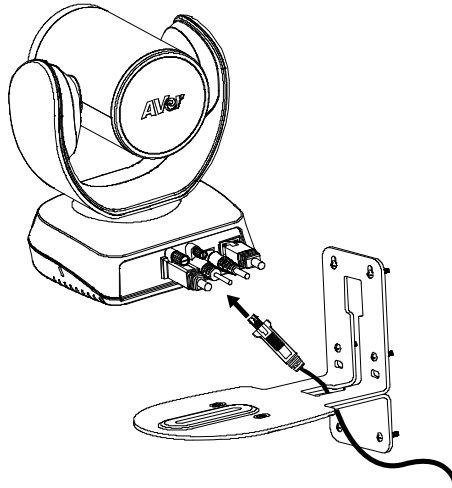

6. Use the remaining screws (included in package) to secure the camera on the L-mount bracket.

**Screw:**  1/4"-20 L=7.5mm (x2)

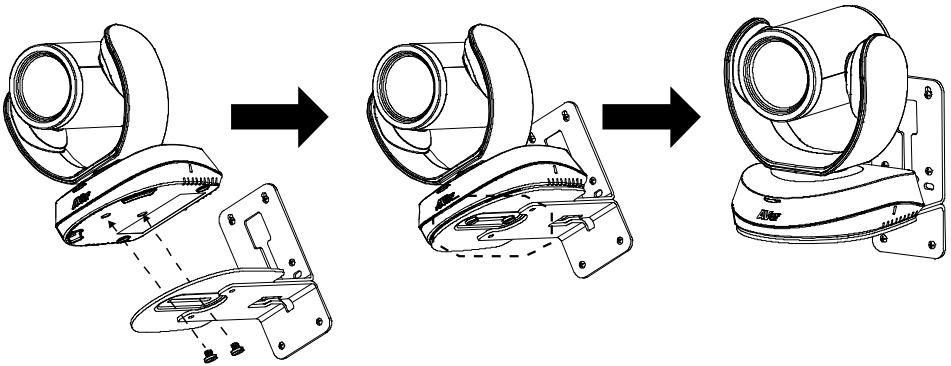

## Ceiling Mount Installation (Optional)

1. Install the provided screw underneath the camera but do not tighten.

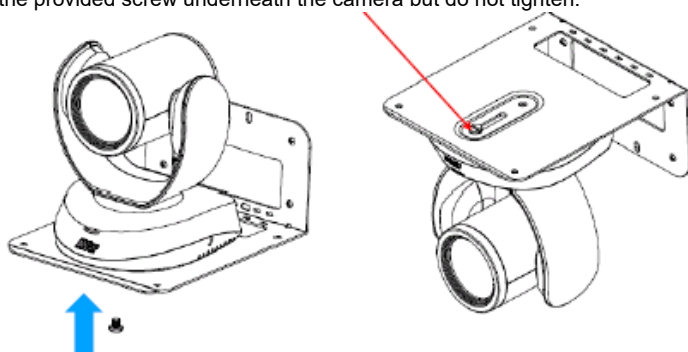

2. Turn the camera to right side.

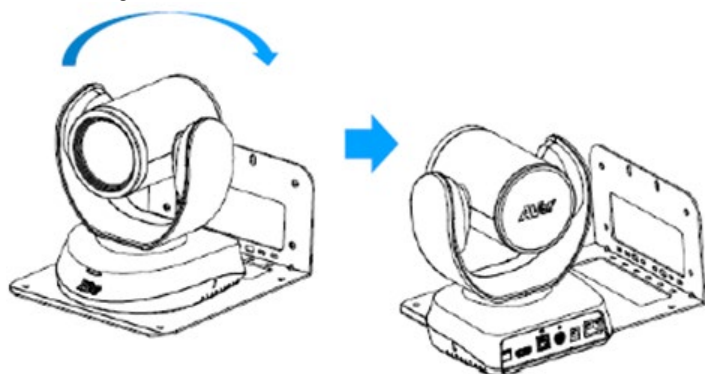

3. Pass cables through A or B hole first. Connect cables with camera.

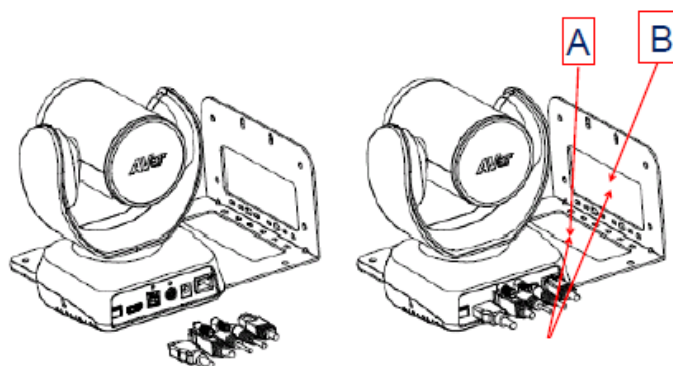

4. Turn the camera to face the front side. Install the second screw and tighten both screws.

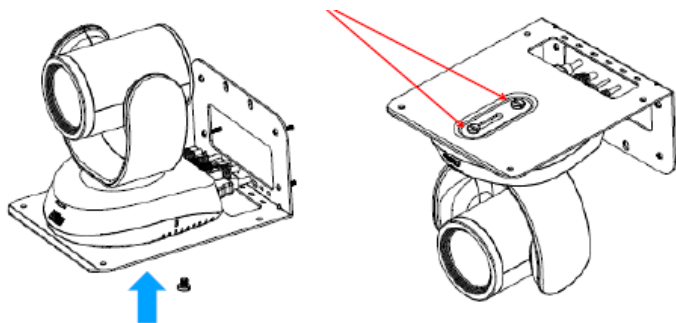

5. Find suitable screws to fix the camera mount to the ceiling.

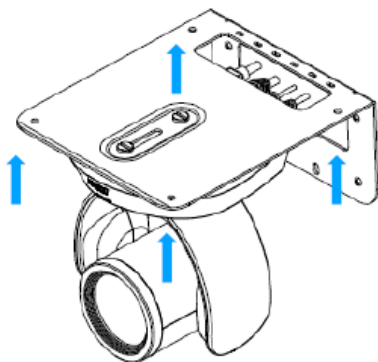

## Secure the Cables

The USB and RS232 cables have a screw on the cable for securing cable on the camera.

Install the cable first and tighten the screw to secure the cable.

**[Note]** Make sure the cable is well connected to the connector on the camera before securing the cable.

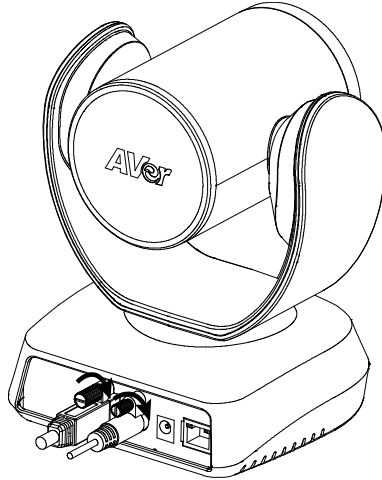

# Operating the Camera

## Make a Video Call

1. Make sure all devices (CAM520 Pro2, laptop/PC, TV/monitor) are well connected and powered on.
2. Run your video application (Zoom, Microsoft® Teams, Skype for Business, Skype, Google Meet, Intel® Unite™, RingCentral, BlueJeans, V-Cube, LiveOn, CyberLink U Meeting®, TrueConf, Adobe Connect, Cisco WebEx®, Fuze, GoToMeeting™, Microsoft® Lync™, Vidyo, vMix, WebRTC, Wirecast, XSplit, etc.) on your PC or laptop.
3. Set the CAM520 Pro2 camera as the primary camera for your video application (refer to your video application user guide). You can now make your call.

**[Note]** The CAM520 Pro2 is a plug-and-play conference camera. The system requires no special drivers, but we do recommend installing the PTZApp 2 for a better user experience. For information on how to install and use the PTZApp 2, refer to the PTZApp 2 section in this user manual.

## Make a Connection through the Browser

CAM520 Pro2 has an Ethernet port for IP streaming and allows administrators to remotely control and set up the camera via an internet access. Moreover, CAM520 Pro2 also supports RTSP and RTMP functions. For more details, please contact our technical support.

1. Make sure the CAM520 Pro2 has an internet access connection.
2. Launch PTZApp 2\* (  ) and connect CAM520 Pro2 to PC with USB cable. The camera default IP address is **192.168.1.168**.



**[Note]** The browser supports:

- Chrome: version 76.x or above
- Firefox: version 69 or above
- IE: Doesn't support

3. Click pencil icon (✎) to edit IP address\*\*.

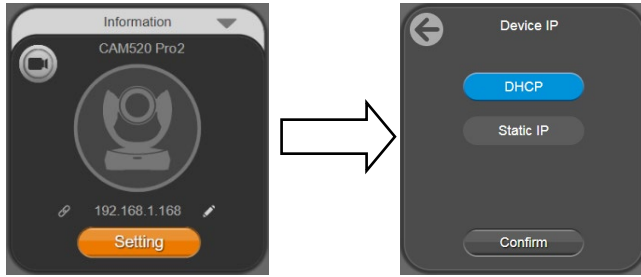

4. Click weblink icon (🔗) to launch Chrome page. Please enter the password (default password is **aver4321**). User will be asked to set a new account and password. (Please enter PTZApp2 to reset password back to default while password is forgotten.)

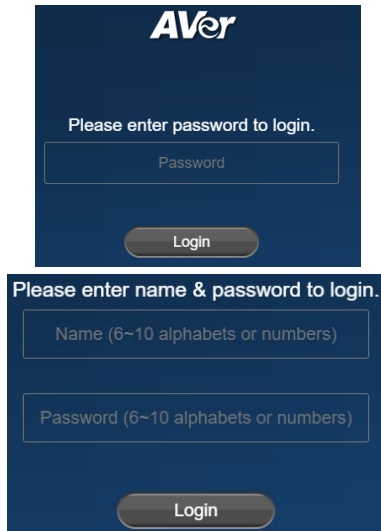

5. After editing IP address, user can access web settings of the camera with only Ethernet cable connection. Unplug the USB cable.

6. The main web screen is displayed as below.

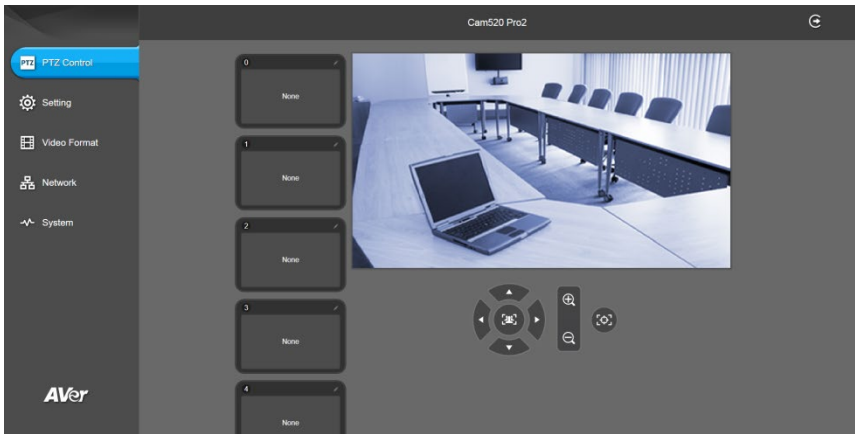

\* For information on how to install and use the PTZApp 2, refer to the PTZApp 2 section in this user manual.

\*\* To support IP address changes in groups, user can download AVer IP Finder app.

1. Download the IP Finder from <https://www.aver.com/download-center> (Global & European Headquarters) or <https://www.averusa.com/business/support/> (USA).
2. Run the IP Finder.
3. Click **“Search”**, and all available devices will be listed on the screen.
4. Select a camera from the list. The corresponding fields of IP address will display.
5. To change the IP address of camera, user can select **“DHCP”** or **“Static IP”**.

The DHCP should get the IP address from local dynamic IP sever. The static IP, user can enter the specific IP address. Click **“Apply”** to apply the setting to the camera. The password is required (default password is **aver4321**).

6. Click **“Search”** button to re-scan the camera.
7. Double-click on the IP address of camera from the list can connect to camera through the browser.
8. Enter the default password (**aver4321**) to login to Web setup screen.

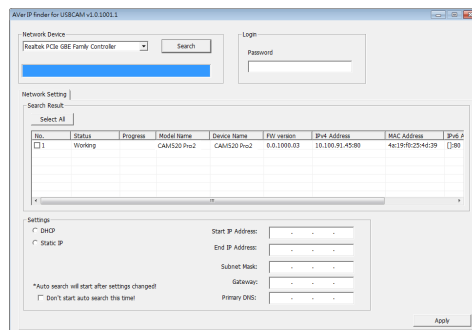

## Web Settings

CAM520 Pro2 supports Ethernet connection; users can enter the IP address into the web browser to connect to the camera for detail settings.

### First Time Login

To find the IP address of the camera, please refer to “**Make a connection through the Browser**” section.

1. Open the browser on your laptop/PC and enter the IP address of the camera.
2. Enter the password at login screen. The default password is “**aver4321**”.
3. The main web screen is displayed.

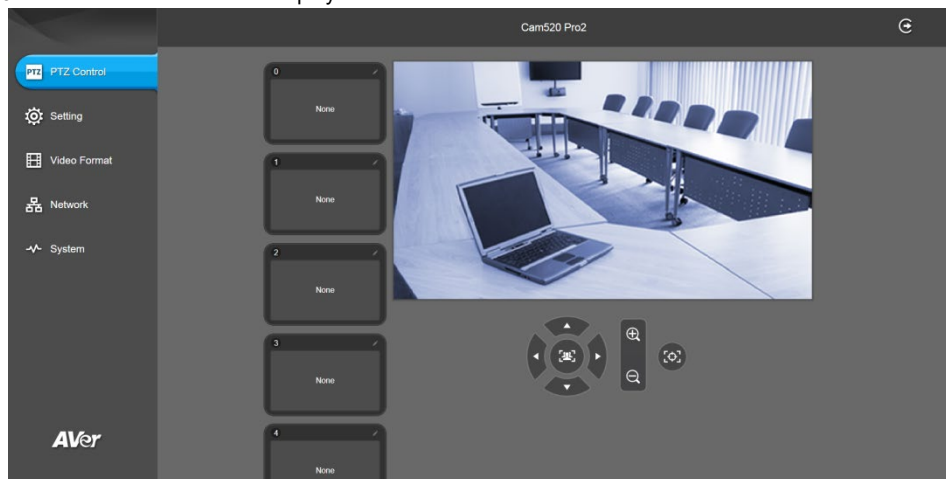



# Live Screen Operation

User can control the camera direction, zoom in/out, and preset selection.

## [Notes]

- The system will force the previous login to log out, when there is a second login.  
If the web page is idle without any request for more than 4 hours, user will be logged out.
- The resolution of live screen is 840x480/ 10fps.

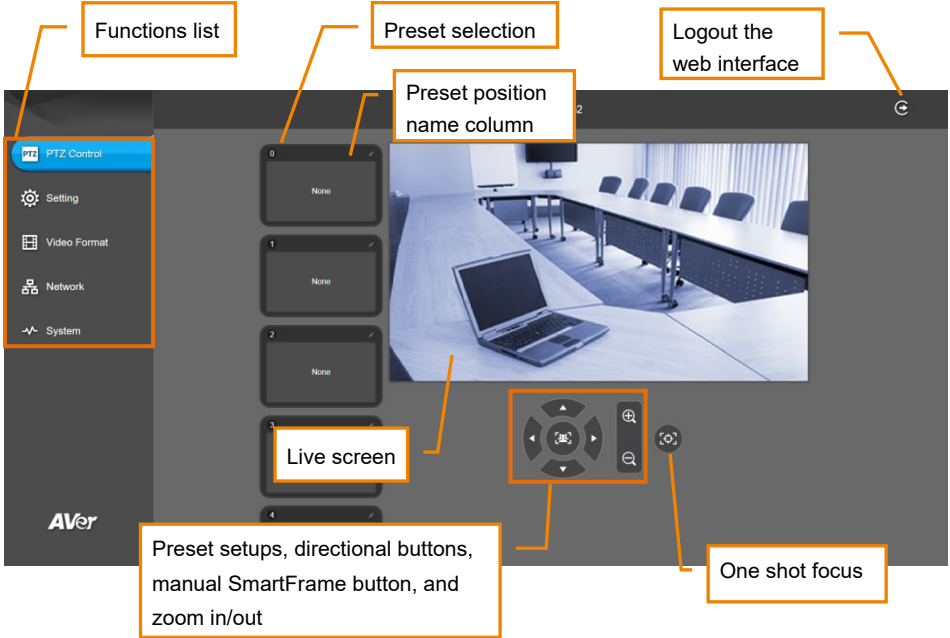

## Set Up the Preset

User can set 10 preset positions.

1. In live screen, use mouse to scroll up or down and click the preset number frame (0~9).
2. Use ▲, ▼, ◀, ▶ and zoom in/out buttons to adjust the camera screen view to desired position.
3. Select “Set Preset” button to save the preset. The system will capture the preset screen view and display in preset number frame.

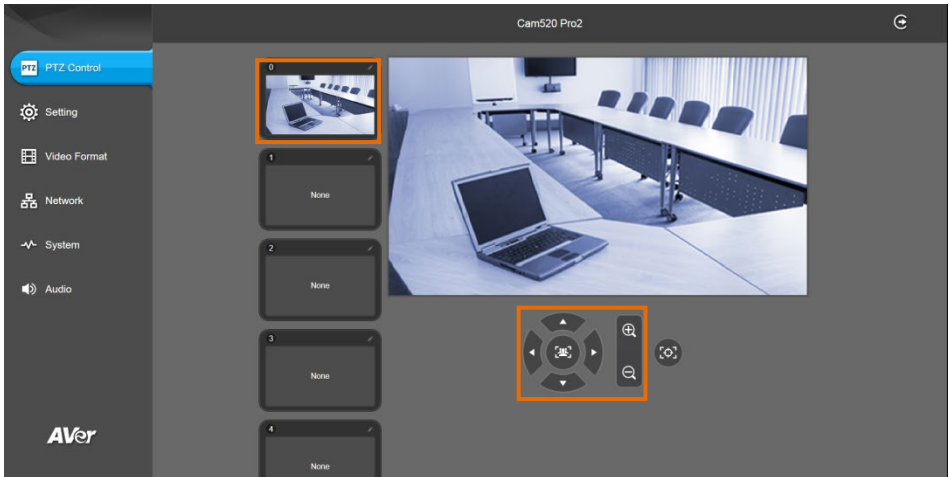

4. Select  icon to edit name of preset frame. Click other Web interface to save the name edited.

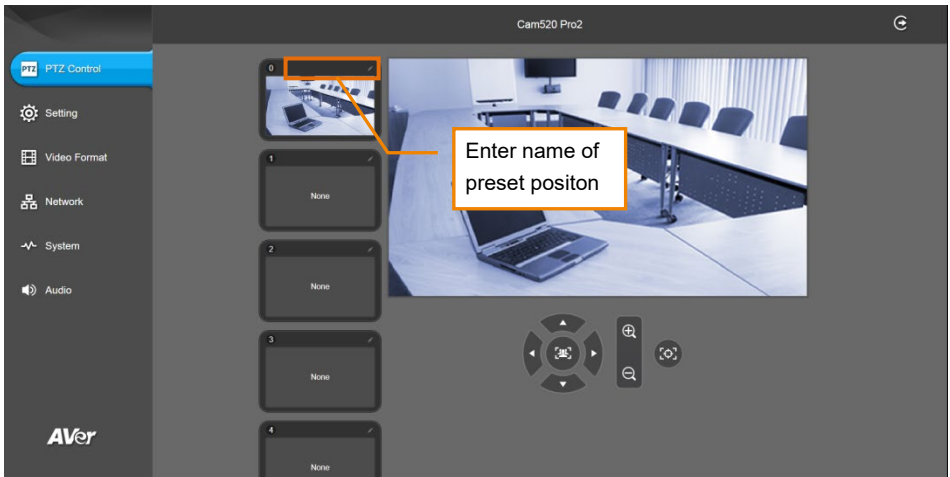

5. To set another preset, repeat the above steps.

## Select the Preset Position

Preset positions need to be set.

Use mouse to scroll up or down to select the preset. The live screen will move to the preset screen view.

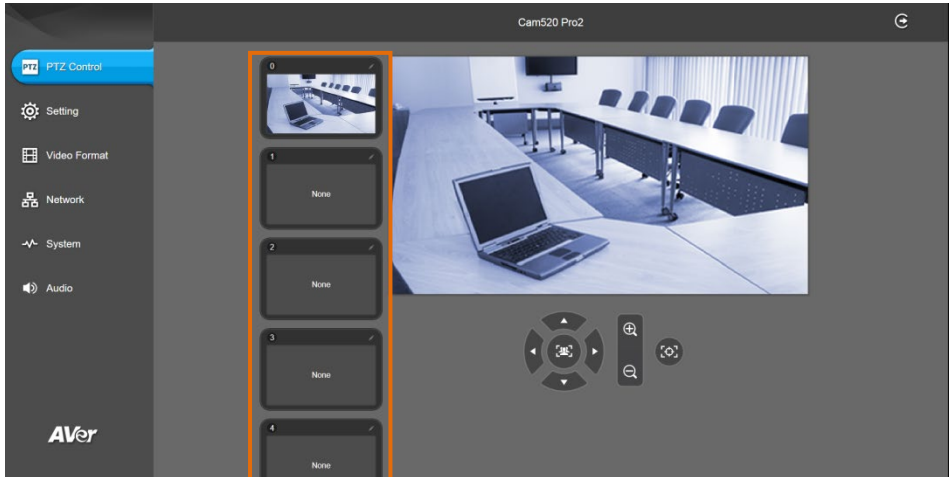

## Camera Settings

The video  icon is to turn on camera live view while adjusting any settings.

IP icon shows the IP address of the camera.

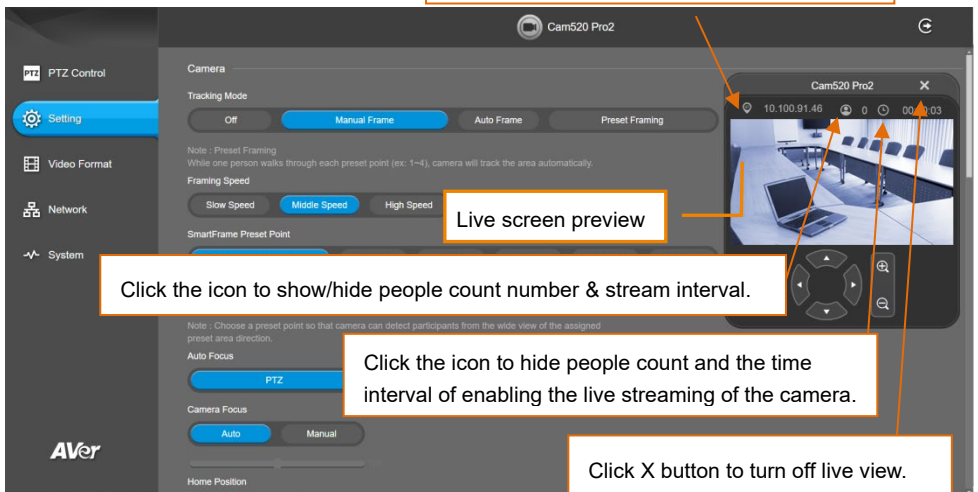

## Tracking Mode

Select **Setting > Camera > Tracking Mode > Off, Manual Frame, Auto Frame, or Preset Framing.**

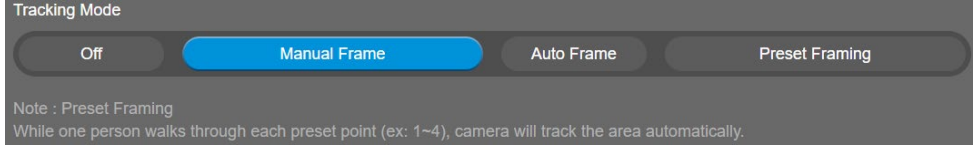

- **Off:** Tracking mode is disabled.
- **Manual Frame:** User one-click SmartFrame button and camera will adjust view angle to fit all participants in screen.
- **Auto Frame:** Camera automatically adjusts view angle to frame all participants on screen every time when it detects participants' faces or bodies. This action will be activated once people in the room sit or stand still for 1~5 seconds, depending on the framing speed you select. Once all the participants are in frame, the camera will keep the image stable by not completing any action until subjects move in or out of the screen. When a participant touches the sides of the screen, it will trigger the camera and automatically track, detect, and frame all the participants again.

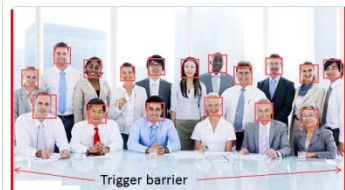

\*The default framing speed is "Middle" speed. "High" speed is more suitable for one person tracking.

- **Preset Framing:** Set up preset points in advance. (Only for Preset points 1~9. Preset 0 is for home position). This is designed for requiring a specific zooming area with preferred image proportion. Camera tracks and frames all the participants in the screen if none of them touch any preset area. When any of them touch a preset area, the camera will immediately shoot the preset zones instead of focusing and zooming into presenter. To keep the screen stable, whenever there is a person in the area, the camera won't move any more until no one shows up. However, the camera can detect the direction where the last person goes. If the person goes to the next preset area with overlap section, the camera will directly move to the next preset area. Thus, to ensure smooth transition, please set up zones with overlapping presets.

If the preset zones do not overlap and when the last person leave the preset area, camera will zoom out to wide to find people and frame them again.

If more than 2 presets areas are touched by 2 persons, camera will go to preset 1. The priority is preset 1>preset2> preset 3....>preset 9

Overlap beginning & end of each zone



**[Note]** CAM520 Pro2 frames people in masks or any facial profile up to 7~10 meters away!

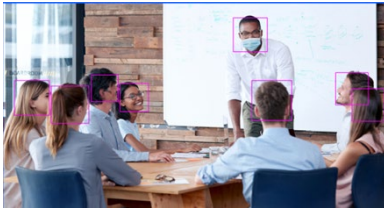

## Framing Speed

Select **Setting > Camera > Framing Speed > Slow Speed, Middle Speed** (default), or **High Speed**.

When in auto framing or preset framing mode, camera will automatically frame people if they stand still without moving for 1~5 seconds.

- **Slow Speed:** camera starts to frame people if they don't move for 5 seconds.
- **Middle Speed:** camera starts to frame people if they don't move for 3 seconds.
- **High Speed:** camera starts to frame people if they don't move for 1 second.

**[Note]** The default framing speed is "Middle" speed. "High" speed is more suitable for one person tracking.

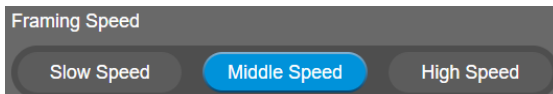

## Smart Frame Preset Point

Select **Setting > Camera > Smart Frame Preset Point > Default(Center of the screen)** or **Preset0 ~ Preset9**.

The default is the central of the image screen. Choose a preset point so that camera can detect participants from the wide view of the assigned preset area direction.



## Auto Focus

Set auto focus mode.

First select **Setting > Camera > Camera Focus > Auto**.

Select **Setting > Camera > Auto Focus > PTZ** or **Continuous**.

- **PTZ:** Click the button (such as pan, tilt, or zoom in/out) to adjust focus once.
- **Continuous:** The camera will adjust the focus when the objects have moved.

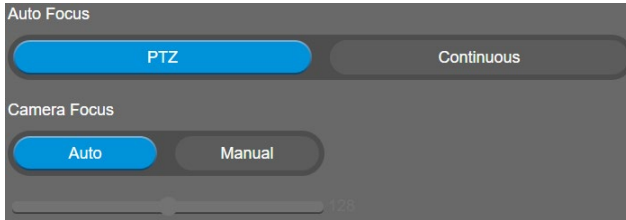

## Camera Focus

Set auto/manual focus mode.

Select **Setting > Camera > Camera Focus > Auto** or **Manual**.

- **Auto:** Camera adjusts focus automatically.
- **Manual:** You can adjust the camera focus by moving the control bar below.

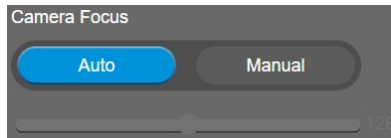

## Home Position

Every time when powering on the camera, it will turn to this position.

Select **Setting > Camera > Home Position > Last Operation Position, Factory Center Position, or Preset 0.**

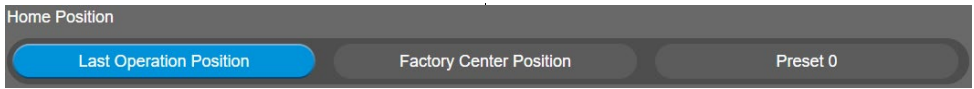

## Sleep Position

When the camera idles for certain period, it will enter sleep mode and go to the sleep position. Please set up sleep timer to enable sleep mode.

Select **Setting > Camera > Sleep Position > Factory Downside Position or Preset 9.**

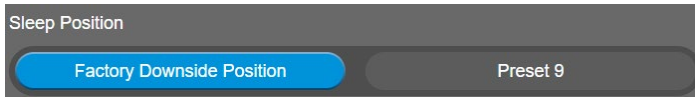

## Sleep Timer

Set the camera idle time to enter sleep mode.

Select **Setting > Camera > Sleep Timer > Off, 10 sec, 5 min, 10 min, or 20 min.**

Please notice that whenever there is USB streaming or RTSP/RTMP streaming, the camera won't enter sleep mode.

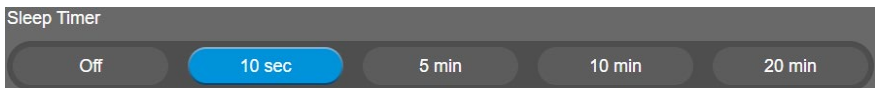

## On Screen Menu

Enable/disable on screen display status information. For instance, when it is at auto frame mode, it will appear "Auto framing" on the bottom of the screen. If you don't want to see the words, please select Off.

Select **Setting > Camera > On Screen Menu > Off, On, or Load Preset Off.**



## Camera Binding

With multiple cameras connection, users can set each camera to buttons 1 to 3 on the remote control.

Select **Setting > Camera > Camera Binding > Camera1, Camera2, or Camera3.**

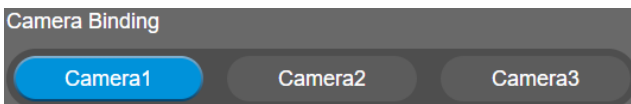

## Save Preset

Enable/disable “save preset” function. When applicable, IT personnel can limit end-user access to change preset points by locking “save preset” function and switching this function off.

When off, user can't save preset points via IR remote, Hot key, VISCA, and webpage.

Select **Setting > Camera > Save Preset > Off or On.**



## Image Settings

### Image Flip

If the CAM520 Pro2 is installed in the upside down position, please enable the "Flip".

Select **Setting > Image > Image Flip > Off or On.**



### Image Mirror

To mirror the camera image.

Select **Setting > Image > Image Mirror > Off or On.**



### True WDR

In back light environment, enable WDR to improve the brightness of image.

Select **Setting > Image > True WDR > Off or On.**

The frame rate will be limited to 30fps while WDR is on.

If user enables this function in a normal light condition, the image will become over exposure and encounter image blur.

When WDR is enabled, camera has taken long exposure and user cannot manually adjust the brightness of image.





## Frequency

Select the frequency of the camera.

Select **Setting > Image > Frequency > 50 HZ** or **60 HZ**.



## White Balance

Select the white balance setting for various light conditions or color temperature.

Select **Setting > Image > White Balance > Auto** or **Manual**.

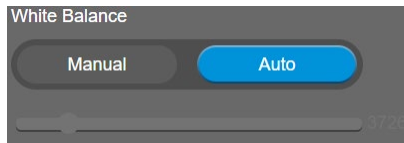

## Noise Reduction

To reduce the noise from the signal.

Select **Setting > Image > Noise Reduction > Off, Low, Middle, or High**.



## Brightness

Adjust the value of brightness.

Select **Setting > Image > Brightness > 1 ~ 9**.

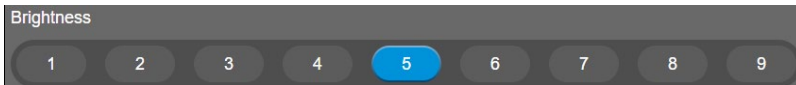

## Sharpness

Adjust the value of sharpness.

Select **Setting > Image > Sharpness > Off, Low, Middle, or High**.



## Saturation

Adjust the value of saturation.

Select **Setting > Image > Saturation > 1 ~ 9**.

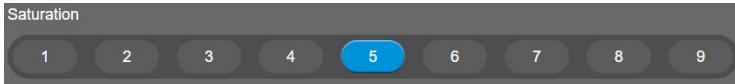

## Low Light Compensation

Select **Setting > Image > Low Light Compensation > Off or On**.

Please notice that the frame rate will drop to 10~15 fps.



## RS232 Settings

When CAM520 Pro2 connects with PTZ camera controller through the RS232 port, please setup **ADDR**, **Baud Rate**, **Protocol**, and **Visca Over IP** settings.

Select **Setting > RS232**.

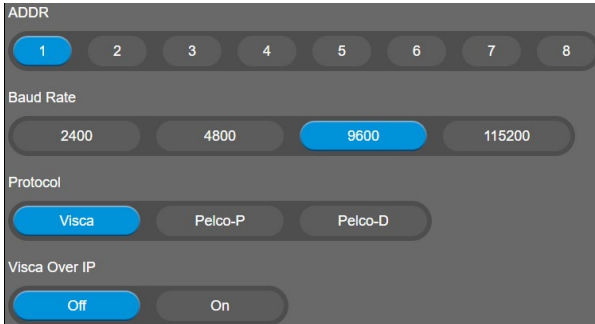

# Video Format Settings

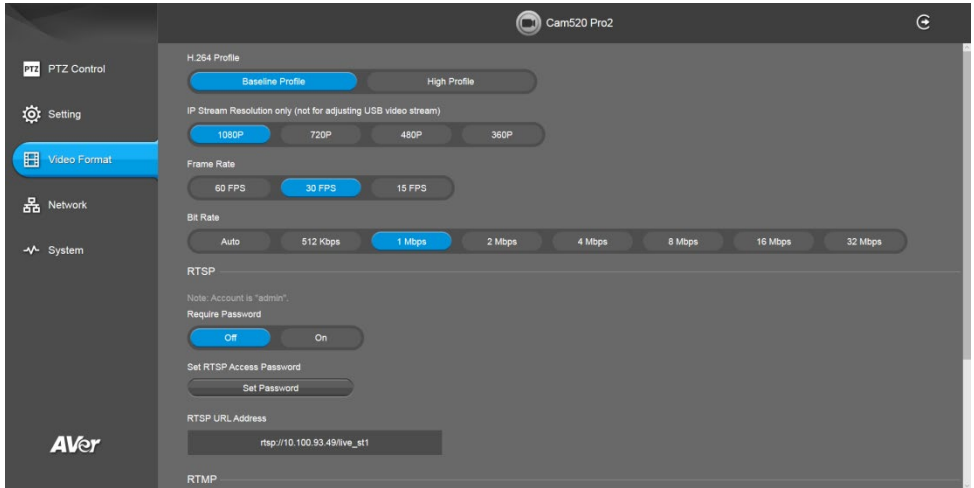

## H.264 Profile

While in live broadcasting, user can choose preferable profile to get best streaming quality.

Select **Video Format > H.264 Profile > Baseline Profile** or **High Profile**.



## IP Stream Resolution

Set up the resolution for IP stream. Not supported for USB video stream.

Select **Video Format > IP Stream Resolution only (not for adjusting USB video stream) > 1080P, 720P, 480P, or 360P**.

Please notice that if USB streaming (VC software side) is already in use at 1080p/30fps, the IP streaming resolution (RTSP) will be limited to 720p/30fps. It's better to disconnect USB streaming while having RTSP/ RTMP IP streaming to ensure the video transmission quality.

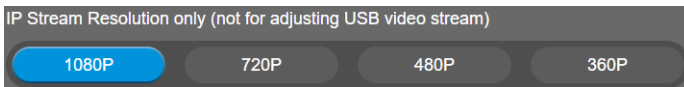

## Frame Rate

Set up the frame rate value.

Select **Video Format > Frame Rate > 60 FPS, 30 FPS, or 15 FPS**.

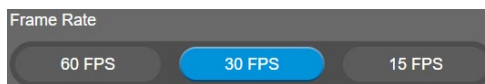

## Bit Rate

Set up the bit rate value.

Select **Video Format > Bit Rate > Auto, 512 Kbps, 1 Mbps, 2 Mbps, 4 Mbps, 8 Mbps, 16 Mbps, or 32 Mbps.**

For Facebook live broadcasting, it's suggested to choose less than 4Mbps to ensure smooth streaming.



## RTSP

To use RTSP player connecting to the camera, please enter the RTSP URL which displays on the web in your application such as VLC, PotPlayer, or Quick Time.

Select **On/Off** to enable/disable password requirement while opening RTSP.

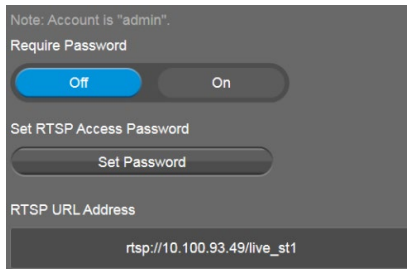

## Change RTSP Password

1. Select **Video Format > RTSP > Set RTSP Access Password.**
2. Enter the new password.
3. Select **Change** to save the new password.

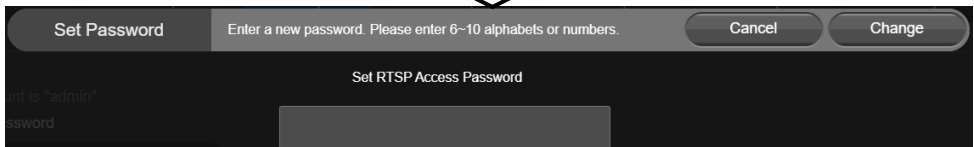
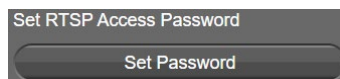

## RTMP

Set up for uploading the camera's live view to the broadcasting platform (e.g. YouTube).

Select **Video Format > RTMP**.

1. Locate the RTMP server URL and stream key from the broadcasting platform and enter in **Server URL** and **Stream Key** fields.
2. Select **Start** to begin uploading the live video of the camera to the broadcasting platform.
3. Select **Stop** to stop uploading the video.

Note: Due to Facebook limitation, to ensure video quality, please set maximum Bitrate at 4Mbps.

Server URL

/

Stream Key

Start Using RTMP

Start

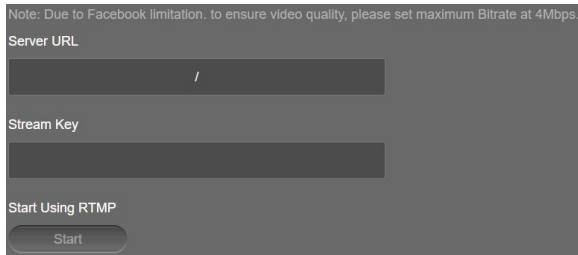

# Network Settings

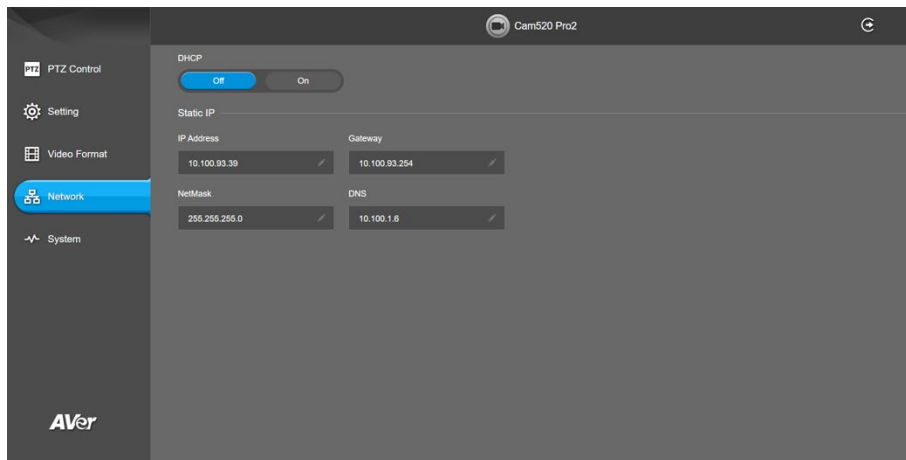

## DHCP

Enable/disable DHCP function.

Select **Network > DHCP > Off** or **On**.



## Static IP

Assign a fixed IP address to the camera. Please turn off the DHCP function.

1. Select **Network > DHCP > Off**.
2. Click pencil icon and enter the **IP Address**, **Gateway**, **NetMask**, and **DNS** in the corresponding fields.
3. Select **Confirm** to complete the setting.

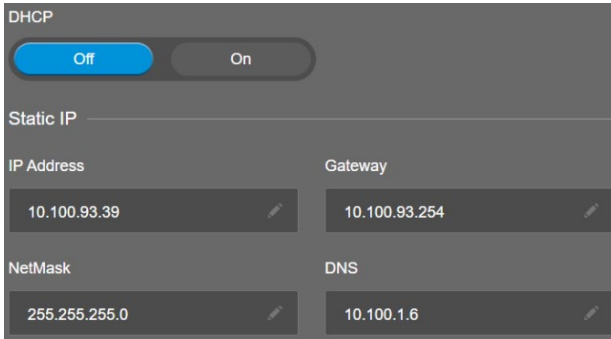

DHCP

Off  On

Static IP

IP Address: 10.100.93.39

Gateway: 10.100.93.254

NetMask: 255.255.255.0

DNS: 10.100.1.6

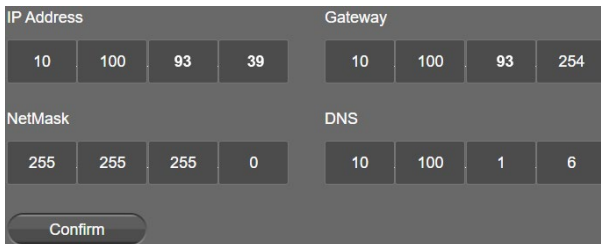

IP Address: 10 100 93 39

Gateway: 10 100 93 254

NetMask: 255 255 255 0

DNS: 10 100 1 6

# System Settings

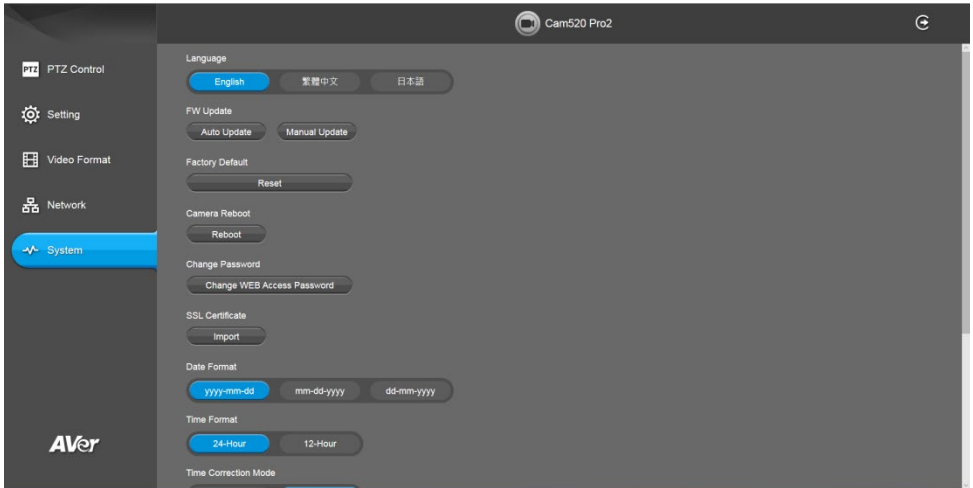

## Language

Select the language of the system.

Select **System** > **Language** > **English**, **Traditional Chinese**, or **Japanese**.

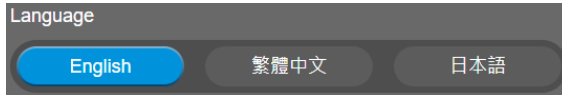

## Firmware Update

Update the camera's firmware.

Select **System** > **FW Update** > **Auto Update** or **Manual Update**.



- **Auto Update:** The system will check firmware version from AVer server and request to update.
- **Manual Update:** To update the firmware from specific location.

After updating, the camera will **reboot** and the connection will be lost. Please wait for few minutes and always keep the power cable connected. If unplugging the power during this process, it will cause damage of the device.



## Factory Default

Reset the camera back to factory default setting.

1. Select **System** > **Factory Default** > **Reset**.
2. User can choose to keep current IP address or back to default.
3. Select **Continue** to reset back to factory default.

**[Note]** When factory default is activated, the password of Webpage login will not be set to default. For security concerns, to reset password of webpage access, please download PTZApp 2 to reset it.

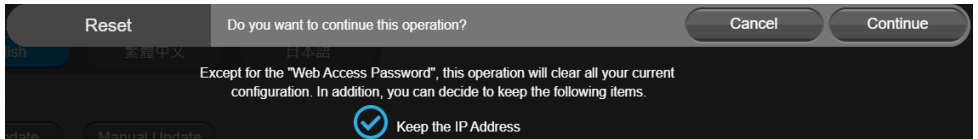
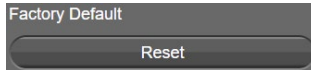

## Camera Reboot

Restart the camera manually.

1. Select **System** > **Camera Reboot** > **Reboot**.
2. Select **Continue** to reboot the camera.

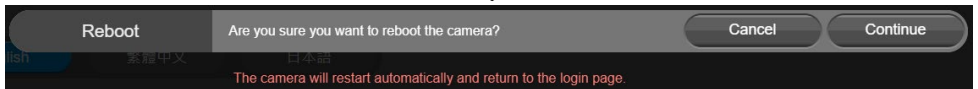
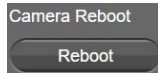

## Change Password

Change the web login password. The default password is “**aver4321**”.

1. Select **System** > **Change Password** > **Change WEB Access Password**.
2. Enter the old account and password. Select **Continue**.
3. Enter the new account and password. Select **Continue** to save the new setting.
4. If users forget the password and want to revert back to the default password, please use PTZApp 2 to reset it.

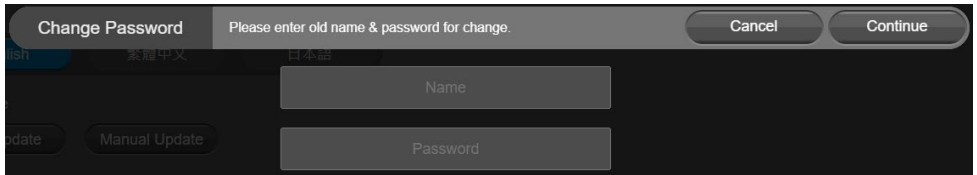
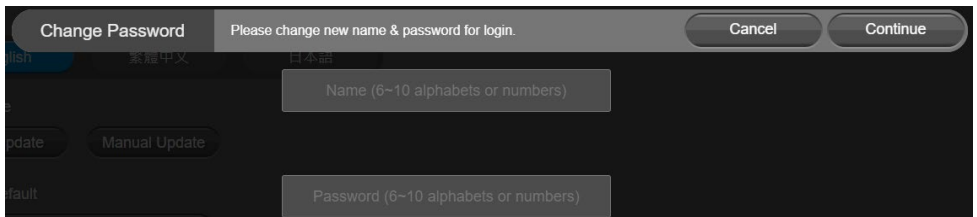
A screenshot of a dark-themed form titled "Change Password". The subtitle reads "Please enter old name & password for change." There are two input fields: "Name" and "Password". At the top right, there are "Cancel" and "Continue" buttons. On the left side, there are language options (English, 繁體中文, 日本語) and a "Manual Update" button.A screenshot of a dark-themed form titled "Change Password". The subtitle reads "Please change new name & password for login." There are two input fields: "Name (6~10 alphabets or numbers)" and "Password (6~10 alphabets or numbers)". At the top right, there are "Cancel" and "Continue" buttons. On the left side, there are language options (English, 繁體中文, 日本語) and a "Manual Update" button.

## SSL Certificate

Import the SSL certificate from specific location.

1. Select **System > SSL Certificate > Import**.
2. Select the type by clicking “+”.
3. Direct the file location.
4. Select **Import**.

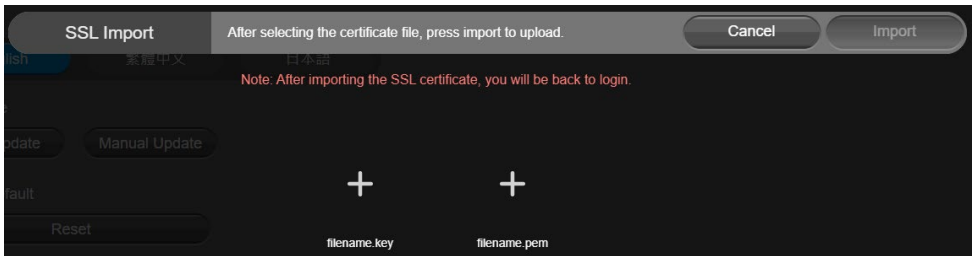
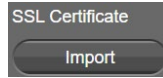

## Date Format

Select the date format.

Select **System > Date Format > yyyy-mm-dd, mm-dd-yyyy, or dd-mm-yyyy**.

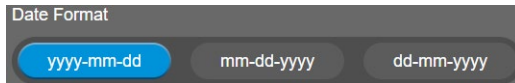

## Time Format

Set up the time format.

Select **System > Time Format > 24-Hour or 12-Hour**.



## Time Correction Mode

Adjust time automatically or manually.

Select **System** > **Time Correction Mode** > **Auto** or **Manual**.

- **Auto:** The system time will be set by NTP server on the network. Click the pencil icon of NTP Server and enter the URL of NTP server. Select the **Time Zone**. Select **NTP Update** to save setting. Select **Confirm** to start auto time adjustment.

**[Note] Our default NTP server is located in the USA.** If this does not work in your country, please manually key in the desired NTP server.

The screenshot shows the 'Time Correction Mode' interface. At the top, there are two buttons: 'Auto' (highlighted in blue) and 'Manual'. Below this, there are three sections: 'NTP Server' with the value 'pool.ntp.org' and a pencil icon; 'Time Zone' with a dropdown menu showing 'UTC-12:00'; and 'NTP Update' with a button labeled 'Update Completed'. At the bottom, there is a 'Time' field showing '2021/4/29 17:42'.



The screenshot shows the 'Time Correction Mode' interface. At the top, there are two buttons: 'Auto' and 'Manual' (highlighted in blue). Below this, there are three sections: 'NTP Server' with the value 'pool.ntp.org'; 'Time Zone' with a dropdown menu showing 'UTC-12:00'; and 'NTP Update' with a button labeled 'Disconnect'. At the bottom, there is a 'Confirm' button.

- **Manual:** User can set up time manually. Click the pencil icon and enter the **Year, Month, Day, Hour, and Minute**. Select **Confirm** to save the settings.

The screenshot shows the 'Time Correction Mode' interface. At the top, there are two buttons: 'Auto' and 'Manual' (highlighted in blue). Below this, there is a 'Time' field showing '2021/4/29 19:01' with a pencil icon. Below the time field, there is a 'Time' section with two columns: 'Year / Month / Day' and 'Hour : Minute'. The 'Year / Month / Day' column has three input fields with values '2021', '04', and '29'. The 'Hour : Minute' column has two input fields with values '19' and '01'. At the bottom, there is a 'Confirm' button.

## Information

Display the information of **Model Name**, **Firmware Version**, **Serial Number**, **IP Address**, and **MAC Address**.

Select **System > Information**.

Model Name	Firmware Version	Serial Number
CAM520 Pro2	0.0.7200.32	1234567890123
IP Address	MAC Address	
10.100.91.93	7e:67:58:f7:1a:6d	

# PTZApp 2

---

In PTZApp 2, user can change the IP address setting of CAM520 Pro2, configure the parameters of the camera, set up AI tracking functions and some advanced image settings, pan, tilt, and zoom the camera.

## Install PTZApp 2

Please go to <https://www.aver.com/download-center> (Global Headquarters), <https://www.aver europe.com/download-center> (European Headquarters), or <https://www.averusa.com/business/support/> (USA) to download the PTZApp 2. After downloading, double-click on the file and follow the on-screen instructions to complete the installation. After installing the PTZApp 2, double-click on the PTZApp 2 icon to run the application.

## Use PTZApp 2 with USB Devices

1. Run your video application and make a video call.
2. During your video call, you can use the PTZApp 2 to pan, tilt and zoom the camera in/out and enable/disable the true WDR, brightness, and sharpness feature.
3. Launch PTZApp 2 (  ) and it will open in Chrome browser automatically.

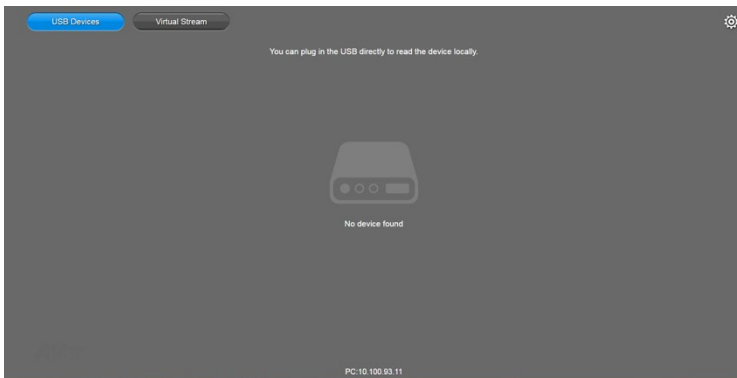

4. Choose “USB device” and connect CAM520 Pro2 to PC/laptop with USB cable. When the camera is detected, the product card will show up.

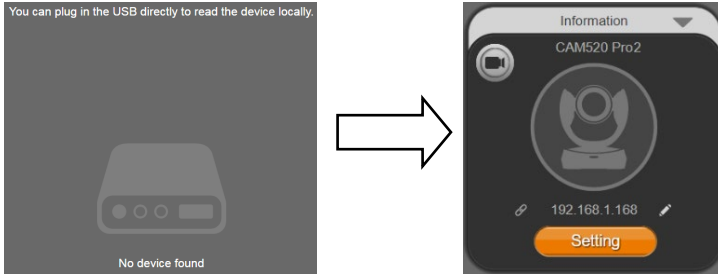

5. Set up IP address. The camera default IP address is **192.168.1.168**. Click pencil icon (✎) to edit IP address.

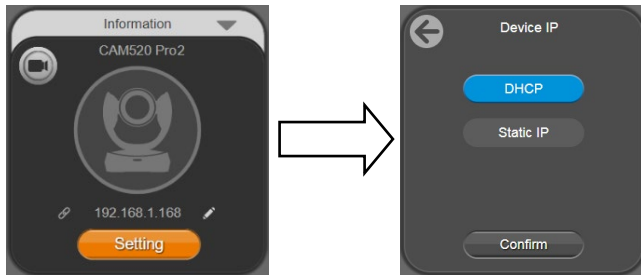

6. Click the setting icon to change Language, Hotkey Control, and PTZApp 2 Version.

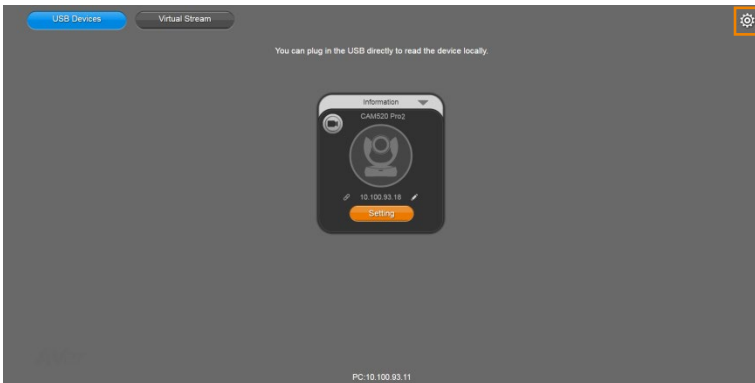

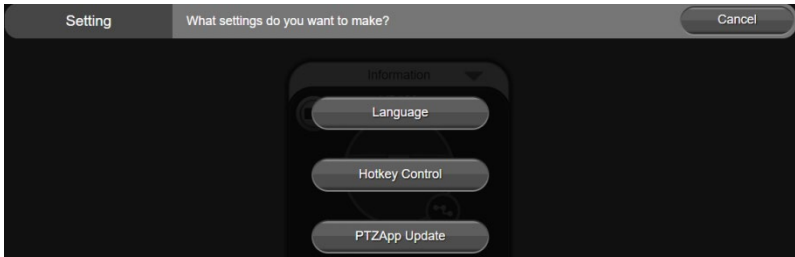

- **Language:** Select desired language and click the check icon to confirm the selection.



- **Hotkey Control:** User can control the camera by using keyboard. This is a general list for all AVer USB Cameras. Backlight control equals to WDR function in CAM520 Pro2.

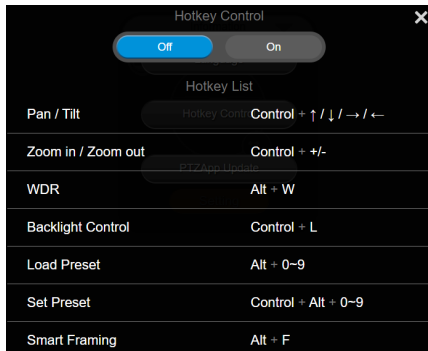

- **PTZApp Update:** Get current PTZApp 2's version number and do auto update here.









7. **Information:** Click the drop-down triangle icon to review the information of camera. To minimize the information, click the triangle or the bottom area of the information icon.



8. **Camera:** Click the camera icon to view the camera live view. IP address is displayed as well. Click the X icon to close the camera live view. If the live video did not appear, please check the camera and the laptop/PC connection to make sure all are correct and well connected.

The resolution of this small live view is 640x480 resolutions.



- **Full Screen:** PTZApp 2 can switch to full screen mode. Click “ ” icon and video screen will switch to full screen mode. In full screen mode, user can use direction panel to control camera direction. Click “ ” icon to go back to normal screen view. The resolution of full screen mode is 1080p/ 30fps.

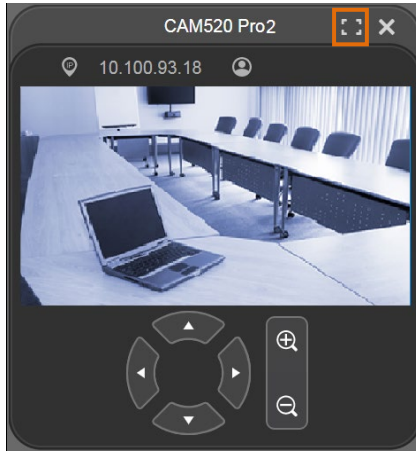

- **People Count and Stream Interval:** Click the  icon to show people count number and stream interval. Click the  or  icon to hide the stream interval.

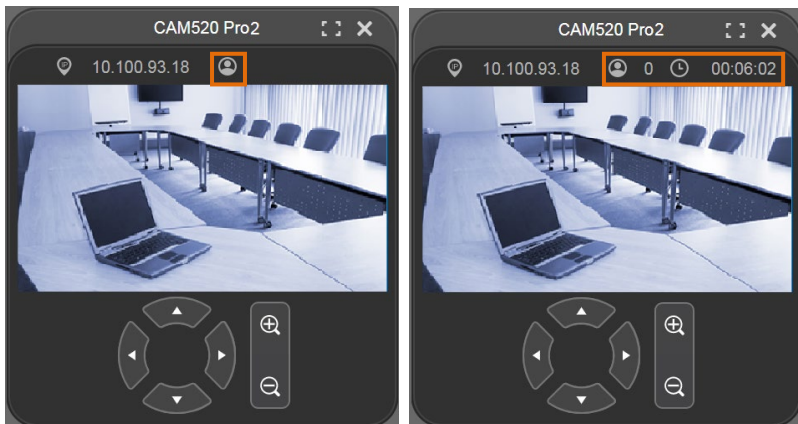

- **Control Panel:** To control the camera direction, zoom in and out during your video call.

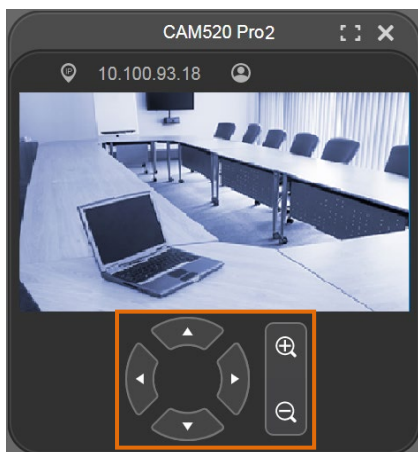

9. **Setting:** Click “**Setting**” button to set up parameters of the camera and speakerphone. Click arrow icon to leave the Setting page.

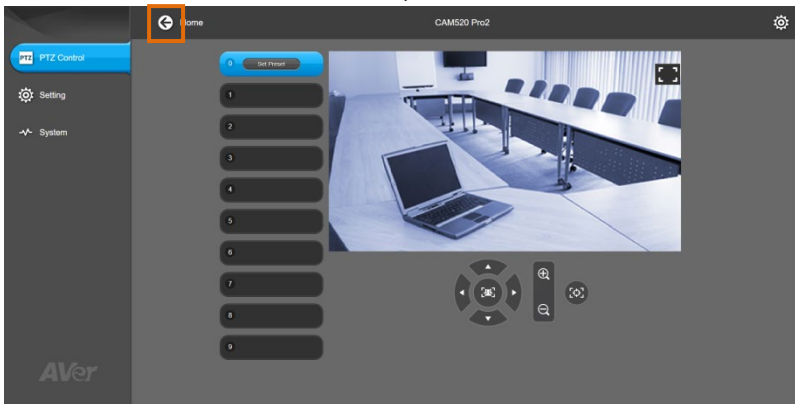
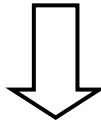

- **PTZ Control:** Use control panel to set up preset positions. Since most of operations are the same as web page, refer to [Set Up the Preset](#) section (pages 26) for detailed setup.
- **Setting:** To set up parameters of the camera. Since most of operations are the same as web page, refer to [Camera Settings](#) , [Image Settings](#) , and [RS232 Settings](#) section (pages 27~34) for detailed setup.
- **System:** To set up system. Since most of operations are the same as web page, refer to [System Settings](#) section (pages 40~45) for detailed setup.

10. **PTZApp 2 Quit & Restore:** To quit the application, right-click the icon on the system tray and select **Quit**. If you can't launch PTZApp 2 right after installation, please right -click the icon and choose **Restore**.

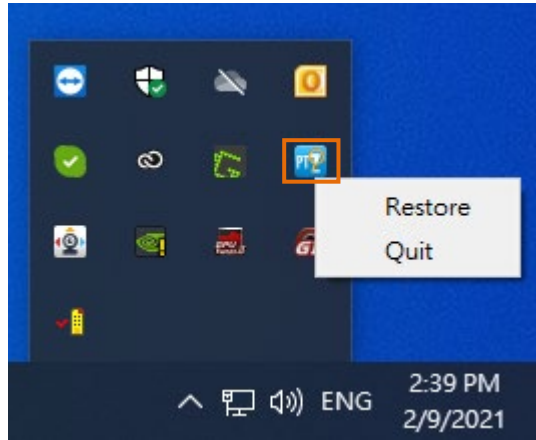

## Use PTZApp 2 with a Virtual Stream

With this function, you can have a virtual meeting with only Ethernet connection and get rid of USB cable connection. Make sure the camera is connected with Ethernet and under the same subnetwork as the meeting room PC (e.g. NUC).

1. Launch PTZApp2 (PTZ) on a PC and click Virtual Stream.

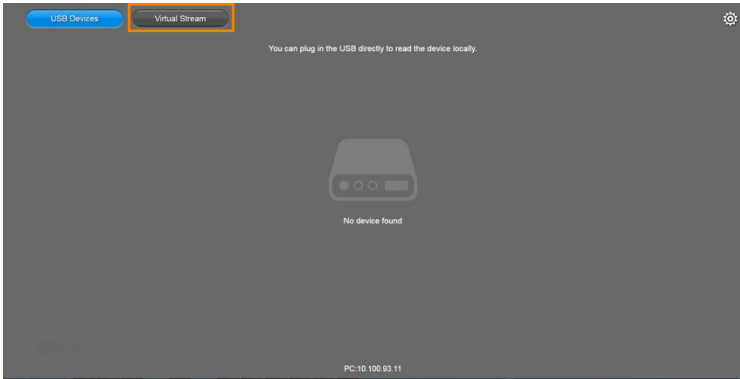

2. When the camera card appears, click **Start** to enable the Virtual Stream function.

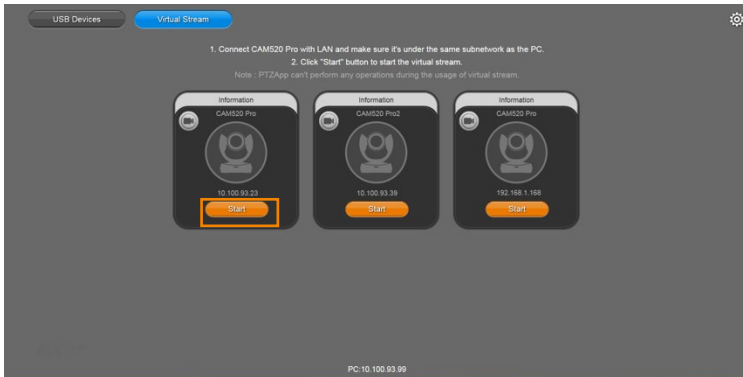

- Virtual Stream technology uses an RTSP stream. If you set a password for RTSP, you will be asked to provide that password while enabling this function.

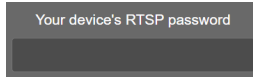

- Launch VC software (e.g. Zoom, Teams, Skype) and choose AVer USB VCam as the video source to start collaborating.
- While using the Virtual Stream function, you cannot change any camera settings. To pan/tilt or zoom in/out the camera, use a remote control or VISCA control.
- Click **Stop** and **Home** to stop using this function.

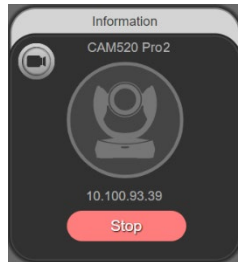

**[Notes]**

- This technology only transmits video, not audio sources.
- Video latency may vary depending on CPU power (i5 or higher is recommended).

# EZLive

Please go to <http://www.aver.com/download-center> to download the AVer EZLive software. After downloading, double-click on the file and follow the on-screen instructions to complete the installation.

## Use AVer EZLive

During a video call, EZLive can help user to do:

- (1) Camera ePTZ
- (2) Volume control for the speaker connected
- (3) Capture camera's still images
- (4) Record video
- (5) Live stream to Youtube, Livehouse.in, USTREAM...etc.
- (6) Camera Zoom in/out
- (7) Capture PC screen shot
- (8) Record PC screen video
- (9) Set up livestream
- (10) Open file management to retrieve photos and video files
- (11) Livestream setting
- (12) Drawing tool

