

avocorTM

AVF-6500*

Super-slim FHD LED Display



Model AVF-6500 Installation/Operation Manual

*Formally known as VTF-6500

COPYRIGHT AND TRADEMARKS:

© Copyright 2016. This document contains proprietary information protected by copyright, trademark and other intellectual property laws. All rights are reserved. No part of this manual may be reproduced by any mechanical, electronic or other means, in any form, without our prior written permission.

The trademarks reproduced in this document and used on the products are either owned or licensed by us, or by their respective holders. You may not reproduce or use the trademarks without our prior written consent.

Important Safety Instructions

- Before using this display, please read this user manual thoroughly to help protect against property damage and to ensure your personal safety and the safety of others.
- Be sure to observe the following instructions.
- For your safety, be sure to observe the warnings located in this manual.
- For installation or adjustment, please follow the instructions in this manual and refer all servicing to qualified service personnel.

Safety Precautions

- If smoke or a peculiar smell comes from the display, remove the power plug from the outlet immediately.
- Failure to do so may result in fire or electrical shock. Contact your dealer for inspection.
- If the display has been turned on but there isn't a picture, remove the power plug from the outlet immediately.
- Failure to do so may result in fire or electrical shock. Contact your dealer for inspection.
- If water is spilled or objects are dropped inside the display, remove the power plug from the outlet immediately.
- Failure to do so may result in fire or electrical shock. Contact your dealer for inspection.
- If the display is dropped or the cabinet is damaged, remove the power plug from the outlet immediately.
- Failure to do so may result in fire or electrical shock. Contact your dealer for inspection.
- To turn off the power of the display, press "O" on the main power switch at side of display.
- The power standby/on indicator will go off and the display cannot to be turned on/off by using the POWER button on the remote control. (To turn on/off the display by the remote control, press the main power switch again and light the power standby/on indicator.)
 - ◆ When turning off the display by pressing the POWER button on the remote control, the main power of the display is not turned off completely.
 - ◆ To disconnect power completely, remove the power plug from the outlet.
- If the power cord or plug is damaged or becomes hot, turn off the main power switch of the display, make sure the power plug has cooled down and remove the power plug from the outlet.
- If the display is still used in this condition, it may cause fire or electrical shock. Contact your dealer for replacement.

Installation

- Don't install in a high-temperature environment.
- If the display is used in high-temperature or in direct sunlight, it may cause the case or other parts to become distorted or damaged, resulting in overheating or electrical shock.
- Don't install in a high-humidity environment.
- This may cause overheating or electrical shock.
- Don't install near any heat sources such as radiators, heat registers, stoves, or other apparatus that produce heat.
- This may cause fire or electrical shock.
- Don't overload outlets or cables beyond electrical capacity.
- Don't use extension cords as it may cause fire or electrical shock.
- Don't insert the power plug into an outlet other than 100~240V AC.
- This may cause fire or electrical shock.
 - ◆ Don't use a damaged power plug or worn outlet.
 - ◆ Don't insert an improper power plug it may cause fire or electric shock.
- Don't place the display on an unstable shelf or surface.
- The display may fall, causing injury. Please install on a horizontal, stable, level surface.
- Don't place objects on the display.
 - ◆ If the display is covered or the vents are blocked, the display could overheat and cause a fire.
 - ◆ If metal or liquid gets into the display, it may cause fire or electrical shock.
 - ◆ Do not put heavy objects on the display as they may fall, causing injury.
 - ◆ Please keep a 10 cm minimum distance between the display and the wall for sufficient ventilation.
- Don't move the display when it is connected to the power cord and AV cables.
 - ◆ When moving the display, make sure to remove the power plug and cables from the outlet or source.
 - ◆ When unpacking or carrying the display, at least 2 people are needed. Make sure the display is carried upright.
 - ◆ Transport the display upright. Avoid placing the display face up or down.
 - ◆ Handle the display gently. Do not drop.

Use

- If you encounter a problem during installation, please contact your dealer for assistance. Don't repair or open the display by yourself.
- Failure to do so may result in fire or electrical shock. Contact your dealer for inspection.
- Protect and correctly use the power cord/plug.
 - ◆ Don't pinch the power cord/plug between hard surfaces.
 - ◆ Don't step on the power cord/plug.
 - ◆ Before inserting the power plug into the wall outlet, connect the power cord to the display.
 - ◆ Don't operate the display with a damaged power cord or it may damage the display.
- Using extension cords (not recommended)
- If an extension cord must be used, ensure the voltage rating exceeds the max power consumption of the display. If the voltage rating is less than the display, it will cause the extension cord to overheat.
- If there is thunder or lightning, don't touch the display or the power plug.
- This may cause an electric shock.
- Don't use any kind of liquid on the display.
 - ◆ If liquid is spilled on the display, remove the power and ask qualified service personnel to check the display.
 - ◆ If the liquid gets on the display's screen, please clean it with a dry and soft cloth immediately.
 - ◆ Don't use any harsh chemical on the display.
 - ◆ If metal or liquid gets into the display, it may cause a fire or an electrical shock.
- Don't install or remove the power plug with wet hands.
- This may cause an electrical shock.
- If the display will not be used for a long period of time, unplug the display.
- This may cause premature wear of electrical components or fire.
- Don't press on the LCD panel.
- This may cause personal injury or panel damage.
- Don't push or shake the display.
- This may cause damage or injury.
 - ◆ If the glass of the display panel is broken, liquid may escape. Please don't touch the liquid.
 - ◆ If liquid get into your eyes or touches your skin, wash with the clean water and seek medical attention immediately.
 - ◆ Precautions with the remote control batteries
 - ◆ Please only use approved AAA type batteries.
 - ◆ Please be sure to insert batteries by matching the + and -.
 - ◆ Don't recharge, heat, disassemble, short or throw batteries into a fire.

- ◆ Don't mix a new battery with a used one.
- ◆ Don't mix different types of batteries together (only use the specified type). it may cause burn and injury.

Cleaning

- If dust has collected on the power plug, remove the plug from the outlet and clean off the dust.
- Dust build-up may cause a fire.
- Take off the power plug before cleaning.
- Failure to do so may result in electrical shock or damage.
- Cleaning the surface of the display
 - ◆ When the surface of the display becomes dirty, please wipe the surface lightly with a soft clean cloth.
 - ◆ If the surface requires additional cleaning, lightly moisten the cloth.
 - ◆ Do not to let any kind of liquid enter the display as it may cause electrical shock or damage.
 - ◆ Do not clean the display with alcohol, solvents or ammonia, as this could damage the display.

Warnings

Use

- Do not use the display lying flat on its back.
- Transport the display upright with proper packaging. Avoid placing the display face up or down. Be careful not to bump into the display.
- Do not send a static (non-moving) image to the display, or it may cause image 'burn-in' or image retention.
- "Burn in" and/or image retention is not covered under warranty.
- Make sure to change the image on the display periodically. It is recommended to (1) turn off the display for at least 6 hours after 18 hours of usage in a 24 hour period to help avoid image retention and (2) to turn the "IRFM" function to "ON" in the OSD menu (under "Advanced Settings").

Exemptions

- This product isn't warranted for any damage caused by natural disaster (such as earthquake, thunder, etc.), fire, acts by third parties, accidents, owner's intentional misuse and fault, or use in other improper conditions.
- This product isn't warranted for incidental damages (such as profit loss or interruption in business, modification or erasure of record data, etc.) caused by use or inability to use of this product.
- This product isn't warranted for any damage caused by inappropriate operation, or from not following the user manual.
- This product isn't warranted for any damage caused by misuse or malfunction through simultaneous use of this product and the connected equipment or software.
- This product isn't warranted for any damage caused by neglect of the instructions described about installation.
- This product isn't warranted for any damage caused by improper installation.
- This product isn't warranted for any damage caused by disassembly, modification or repair by non-authorized service centre or people.

Compliance Information

DECLARATION OF CONFORMITY:

AVOCOR hereby declares that the Products' Model Number:

AVF-6500

Conform with the provisions of:

- FCC :
FCC CFR Title 47 Part 15 Subpart B Class A, CISPR 22
ANSI C63.4
ICES-003 Issue 5
- CE :
EN 55022
EN 55024
EN 61000-3-2
EN 61000-3-3
EN 300 328
EN 301 489-1/-17
- cTUVus :
UL 60950-1
CAN/CSA-C22.2 No. 60950-1
- CB:
IEC 60950-1

FCC PART 15:

This equipment has been tested and found to comply with the limits for a Class A digital device, pursuant to part 15 of the FCC Rules. These limits are designed to provide reasonable protection against harmful interference when the equipment is operated in a commercial environment. This equipment generates, uses, and can radiate radio frequency energy and, if not installed and used in accordance with the instruction manual, may cause harmful interference to radio communications. Operation of this equipment in a residential area is likely to cause harmful interference in which case the user will be required to correct the interference at his own expense.

CAUTION:

Any changes or modifications not expressly approved by the grantee of this device could void the user's authority to operate the equipment.

RF Exposure Warning:

This equipment must be installed and operated in accordance with provided instructions and the antenna(s) used for this transmitter must be installed to provide a separation distance of at least 20 cm from all persons and must not be co-located or operating in conjunction with any other antenna or transmitter. End-users and installers must be provide with antenna installation instructions and transmitter operating conditions for satisfying RF exposure compliance.

INDUSTRY CANADA (ICES-003):

CAN ICES-3 (A)/NMB-3(A)

PRODUCT DISPOSAL:

The Product contains small amounts of tin, lead and/or mercury. Disposal of these materials maybe regulated due to environmental considerations.

DISPOSAL OF OLDELECTRICAL ANDELECTRONIC EQUIPMENT (Applicable throughout the European Union and other European countries with separate collection programs)

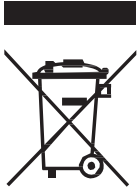

This symbol found on your product or on its packaging, indicates that this product should not be treated as household waste when you wish to dispose of it. Instead, it should be handed over to an applicable collection point for the recycling of electric al and electronic equipment. By ensuring this product is disposed of correctly, you will help prevent potential negative consequences to the environment and human health, which could otherwise be caused by inappropriate disposal of this product.

The recycling of materials will help to conserve natural resources. This symbol is only valid in the European Union. If you wish to discard this product, please contact your local authorities or dealer and ask for the correct method of disposal.

Notes

Table of Contents

Important Safety Instructions	3
Safety Precautions	3
Installation	4
Use	5
Cleaning	6
Warnings	7
Use	7
Exemptions	7
Compliance Information	8
Table of Contents	11
List of Figures	13
1. Introduction	15
About This Manual	15
Target Audience	15
Textual and Graphic Conventions	15
Using This Manual	16
Description, Features and Benefits	17
Key Features and Benefits	17
Touch Capability:	17
Parts List	17
2. Controls and Functions	19
Display at a Glance	19
Input Panel	21
Remote Control Unit	23
3. Installation	25
Remote Control	25
Notes on Batteries	25
Notes on Remote Control Operation	25
Quick Setup	26
Installation Considerations	26
Ambient Light	26
Ambient Heat	26
Ventilation	27
Mounting the Display	28
Connections to the Display	28
Connecting a Control System or PC:	29
Connecting Source Components to the Display	31
Turning on the Power	33
Changing the OSD Language	34
Enabling the Touch Screen	34
Connecting the Touch Screen Controller Host Computer to the Display	34
Software Installation	35

- 4. Operation..... 39**
 - Using the On-Screen Menus 39**
 - Video Settings 41
 - Audio Settings 46
 - Basic Settings 47
 - Advanced Settings 49
 - System 52
- 5. Maintenance and Troubleshooting 53**
 - Maintenance 53
 - Troubleshooting 53
- 6. External Control 56**
 - Serial Communications 56**
 - RS-232 Connection and Port Configuration 56
 - Command and Response Format 56
 - Command and Response Examples 57
 - Serial Command List 57
 - Using Discrete IR Codes 64**
 - IR Command Protocol 64
 - IR Control Code List 65
- 7. Specifications 67**
 - Supported Timings 69
 - Overall Dimensions 70
- Appendix I: Moving and Carrying Notice 72**
 - Moving the Display: 72
 - Carrying the display: 72
- Appendix II: Installing a Wall Mount 73**
- Appendix III: Wall Mount Safety Notes 74**
- Appendix IV: Power/PC Key Operations 76**
- Appendix V: Ethernet Remote Control Settings 77**
 - Configurations 77**
 - Administrator 77
 - TCP Mode 80
 - UDP Mode 81
 - UART 82
 - SMTP 83
 - Reset Device 84

List of Figures

Figure 2-1. Display Rear/Side/Front View.....	19
Figure 2-2. Display Input Panel Side/Front View	21
Figure 2-3. Display Remote Control Unit	23
Figure 3-1. Ventilation Requirements for Enclosure Mounting.....	27
Figure 3-2. RS-232 Control System Connection	29
Figure 3-3. Ethernet Connection	30
Figure 3-4. DisplayPort Source Connection	31
Figure 3-5. HDMI Source Connections	32
Figure 3-6. VGA Source Connections	33
Figure 3-7. Touch Screen Controller (USB) Connection.....	34
Figure 4-1. OSD Menu Structure	40
Figure 4-2. Typical PLUGE Pattern for Adjusting Brightness	41
Figure 4-3. Typical Grey Bar Pattern for Adjusting Contrast	42
Figure 4-4. Typical Test Pattern for Adjusting Sharpness	42
Figure 4-5. Typical Colour Bar Pattern for Adjusting Colour Saturation and Hue	43
Figure 4-6. CIE 1931 Chromaticity Diagram	44
Figure 7-1. AVF-6500 Display Dimensions.....	70

Notes

1. Introduction

About This Manual

This Owner's Manual describes how to install, set up and operate the AVOCOR Series LED Display.

Throughout this manual, the AVOCOR Series LED Display is referred to as the "display".

Target Audience

The manufacturer has prepared this manual to help installers and end users get the most out of the display.

The manufacturer has made every effort to ensure that this manual is accurate as of the date it was printed. However, because of ongoing product improvements and customer feedback, it may require updating from time to time.

Textual and Graphic Conventions

Text Conventions: The following conventions are used in this manual, in order to clarify the information and instructions provided:

- Remote and built-in keypad button identifiers are set in upper-case bold type; for example, "Press **EXIT** to return to the previous menu."
- Computer input (commands you type) and output (responses that appear on-screen) is shown in monospace (fixed-width) type; for example: "To change the aspect ratio to Letterbox, type 07 00 02 41 53 50 03 08 <Enter>."
- All keys with functional names are initial-capped, set in bold type and enclosed in angle brackets. These keys are the following: <Enter>, <Spacebar>, <Control>, <Esc> and <Tab>. <Enter> indicates that you may press either the RETURN or ENTER key on your keyboard if it has both keys.
- In addition to these conventions, underlining, boldface and / or italics are occasionally used to highlight important information, as in this example:



NOTE

A carriage return must be used after each command or string.

Graphic Conventions: These symbols appear in numerous places throughout the manual, to emphasise points that you must keep in mind to avoid problems with your equipment or injury:



TIP

TIPS highlight time saving short cuts and helpful guidelines for using certain features.



NOTE

NOTES emphasise text with unusual importance or special significance. They also provide supplemental information.



CAUTION

CAUTIONS alert users that a given action or omitted action can degrade performance or cause a malfunction.



WARNING

WARNINGS appear when a given action or omitted action can result in damage to the equipment, or possible non-fatal injury to the user.



DANGER!

DANGER appears when a given action can cause severe injury or death.

Using This Manual

Use the following table to locate the specific information you need in this manual.

If you need...	... Turn to page:
General information about the AVOCOR Series LED Display	17
Installation instructions	25
First-time configuration instructions	34
Advanced configuration instructions	49
Troubleshooting tips	53
Product specifications	67

Description, Features and Benefits

The AVOCOR Series LED Display represents the cutting edge of direct-view LCD technology.

They combine ultra-high resolution and unparalleled image quality with configurable I/O in a large-format display for a wide range of digital signage and control-room applications.

Key Features and Benefits

The display offers these key features and benefits:

- Full-HD Native Resolution: 1920 x 1080 (16:9 Native Aspect Ratio)
- High-resolution, high-speed InGlass™ touch sensing for up to 10 simultaneous touches
- DisplayPort 1.2, HDMI with High-bandwidth Digital Content Protection (HDCP), VGA, RS232, Touch USB, and LAN connections
- Direct LED Backlight with active ambient light sensor to adjust backlight automatically
- Ultra-wide 178 degree Viewing Angle

Touch Capability:

- Precise, highly-responsive touch technology
- High touch sensitivity – no pressure required
- Any touch: finger, gloved hand or pointer
- Calibrated easily by software tools as attached
- Windows 7/8/10 compliant
- One USB cable for easy Plug-and-Play operation

Parts List

Your display is shipped with the following items. If any items are missing or damaged, please contact your dealer or Customer Service.

- AVOCOR FHD LED Display
- Remote Control Unit and Batteries
- AC Power Cord
- Touch Stylus
- RF Antenna
- USB Key – Multi-Touch Drivers & User Manual
- USB Cable - 3 Metres
- HDMI Cable - 3 Metres
- VGA Cable - 3 Metres

Notes

2. Controls and Functions

Display at a Glance

Figure 2-1 shows the key display components, and the paragraphs that follow describe them.

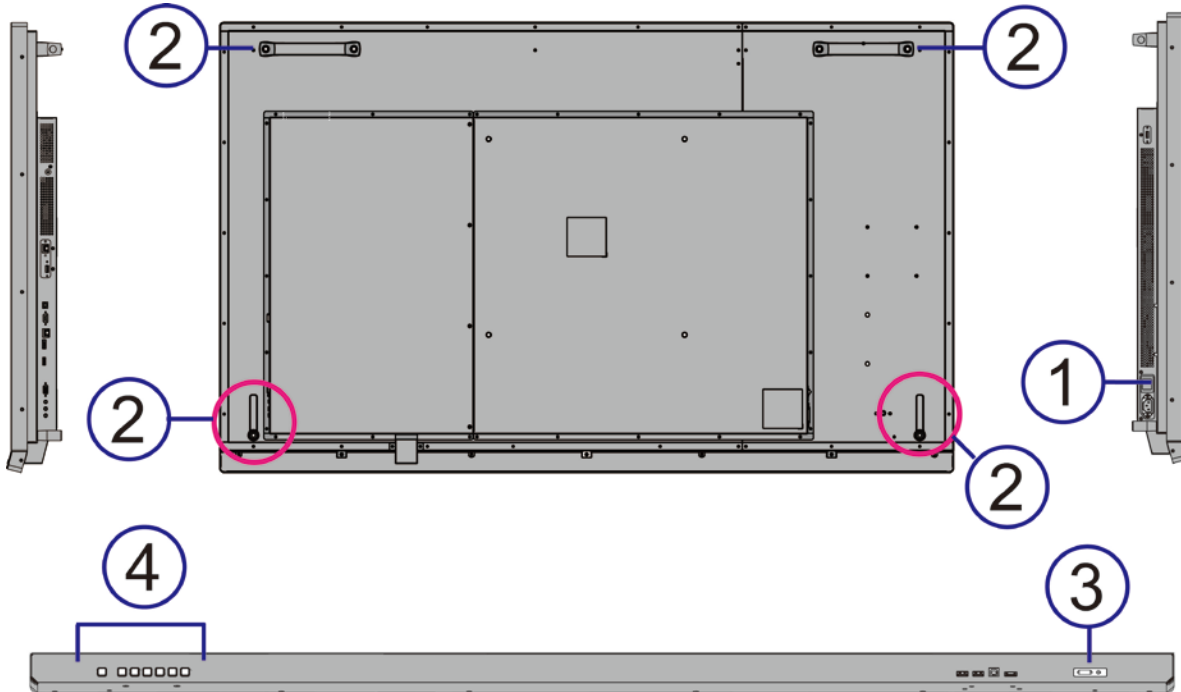

Figure 2-1. Display Rear/Side/Front View

1. MAIN POWER SWITCH

Connects or disconnects the display panel from the AC power source.

2. HANDLE

Always use the upper handles and lower handlebars when carrying the display.

DO NOT touch / hold the screen face or the lower front panel.

3. STATUS LED

Solid orange: display in standby mode

Blinking orange: display on, no input detected

Off: main power switch off

Solid green: display on, input detected

4. KEYPAD

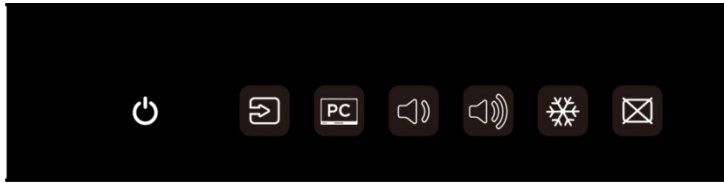

You can use the keypad instead of the remote control unit to operate the on-screen display (OSD) controls. The keypad operates as follows:

POWER 

Press the button to turn on/off the display screen. (Refer to Appendix IV for detailed operations)

SOURCE 

Press the button to select a media source. When using Win10 PC, pressing this button will return to the previous source selected.

Win10 PC 

Press the button to turn on/off the Win10 PC that's built in the display. (Refer to Appendix IV for detailed operations)

VOLUME DOWN  / UP 

Press these two buttons to lower or increase the volume.

FREEZE 

Press the button to freeze the screen. Press again to release it.

BLANK 

Press the button to blank the screen.

Input Panel

Figure 2-2 shows the display input panel located at both sides and lower front of the display.

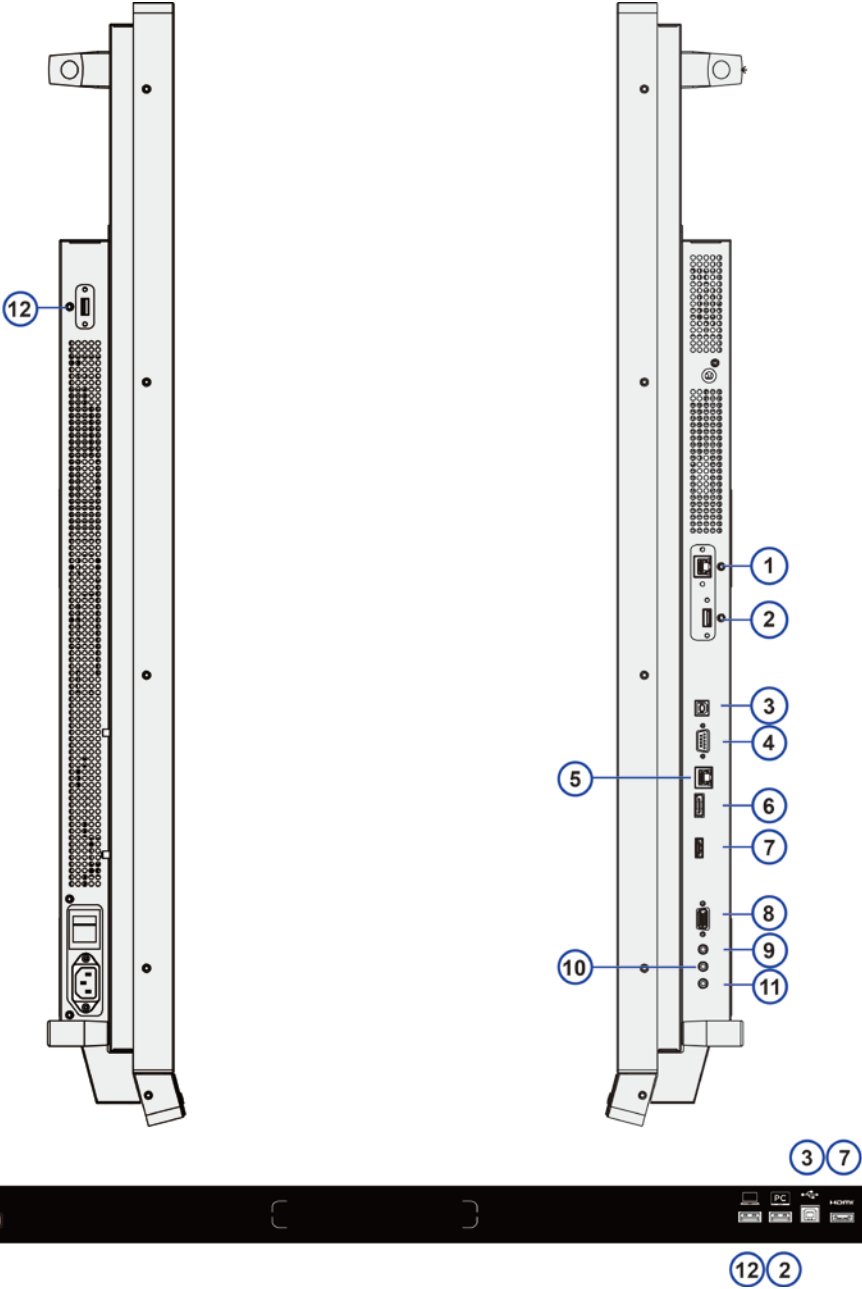

Figure 2-2. Display Input Panel Side/Front View

No.	Connector
1	WIN PC Ethernet An RJ-45 connector for interfacing with the built-in Windows PC via a Cat 5 cable.
2	WIN PC USB Two standard USB connectors of the Windows mini PC for connecting external multimedia player devices.
3	Hub In (Touch USB) Two standard, Type-B USB port for connecting media sources to the display. <i>Note: The USB cable used for the front Hub In connector can be up to 3 metres in length, while the one used for the rear Hub In connector can be up to 5 metres in length.</i>
4	RS232C In A female, 9-pin D-sub connector for interfacing with a PC or home theatre automation/control system.
5	LAN Port An RJ-45 connector for interfacing with a PC or home theater automation/control system via a Cat 5 cable.
6	DisplayPort DisplayPort 1.2 and DisplayPort-HDCP 1.1 compliant, SD/HD input for connecting SDTV, EDTV or HDTV component video sources.
7	HDMI HDCP-compliant digital video input for connecting HDMI sources.
8	VGA In (15-pin D-Sub) Connects components that have RGB or component output jacks, such as a personal computer or external DTV decoder (a break-out cable is needed for BNC-type connection).
9	PC Audio In Connects the audio output from a personal computer here.
10	IR Extender Connects an IR Extender cable from this input.
11	Audio Out Connects external, powered speakers or an external audio receiver/amplifier.
12	HUB USB Two standard USB connectors for connecting external media, keyboard, or mouse.









Remote Control Unit

Figure 2-3 shows the display remote control, and Table 2-1 describes its functionality.



Figure 2-3. Display Remote Control Unit

Table 2-1. Remote Control Button Descriptions

Label	Description
	Turns the display screen on and off. (Refer to Appendix IV for detailed operations.)
	Selects a media source.
	Turns on WIN PC, and selects WIN PC input source. (Refer to Appendix IV for detailed operations.)
	Blanks the screen. Press any key to restore.
	Freezes the screen. Press again to restore.
	Turns off the sound.
	Increases or decreases the volume by pressing the + and - keys.
	Selects standard settings.
	Opens the monitor's on-screen menu system.
	When the menu system is already open, pressing this button will select the previous submenu.
	Navigates through submenus and settings.
ENTER	Selects highlighted menu choices
EXIT	Closes the menu system
AUTO	Auto adjustment of VGA source
SCALING	Selects each aspect ratio, in sequence: Full Screen, Native, Letter Box and Pillar Box

3. Installation



NOTE Installation **must** be performed by a qualified custom video installation specialist.

Remote Control

To install batteries in the remote control:

1. Press down the tab on the cover and pull the cover up.
2. Insert the included batteries. Ensure that the polarities correctly match the \oplus and \ominus markings inside the battery component.
3. Insert the lower tab of the cover into the opening, and press down the cover until it clicks in place.

Notes on Batteries

Make sure that the battery polarities are correct when installing the batteries.

- Do not mix an old battery with a new one or different types of batteries.
- If you will not use the remote control for a long time, remove the batteries to avoid damage from battery leakage.
- Do not expose batteries to excessive heat such as from sunshine, fire or the like.

Notes on Remote Control Operation

- Make sure that there is nothing obstructing the infrared beam between the remote control and the IR receiver on the display.
- If the effective range of the remote control decreases, or it stops working, replace the batteries with new ones.
- The remote control may fail to operate if the infrared remote sensor is exposed to bright sunlight or fluorescent lighting.
- Ambient conditions may possibly impede the operation of the remote control. If this happens, point the remote control at the display, and repeat the operation.

Quick Setup

Table 3-1 gives a quick overview of the display installation process. The sections following this one provide detailed instructions.

Table 3-1. Installation Overview

Step	Procedure	For Details, Refer to page...
1	Mount the display(s) on a wall (optional)	28
2	Connect other external equipment to the display (optional): Automation/control system (RS-232, Ethernet)	29
3	Connect signal sources to the display	31
4	Apply power to the display	33
5	Change the OSD language (optional)	34
6	Perform touch screen-specific installation and configuration tasks (AVOCOR): Connect touch screen controller host computer to the display	34
7	Display calibration: adjust the following for each input: <ul style="list-style-type: none">• Aspect ratio• Colour level• Brightness• Contrast• Tint• Input position• Colour temperature and white balance	41

Installation Considerations

Proper installation of your display will ensure a satisfying viewing experience. Whether a display is installed temporarily or permanently, the following should be taken into account to ensure the best performance of the display.

Ambient Light

In general, minimise or eliminate light sources directed at the screen. Contrast ratio in your images will be noticeably reduced if light directly strikes the screen, such as when a shaft of light from a window or floodlight falls on the image. Images may then appear washed out and less vibrant. Direct sunlight may affect touch operation.

Ambient Heat

Keep the ambient temperature constant and below 35°C (95°F). Keep the display away from heating and / or air conditioning vents.

Ventilation

If you are mounting the display in an enclosure, leave sufficient space on all sides between it and surrounding objects, as shown in Figure 3-1. This allows heat to disperse, maintaining the proper operating temperature.

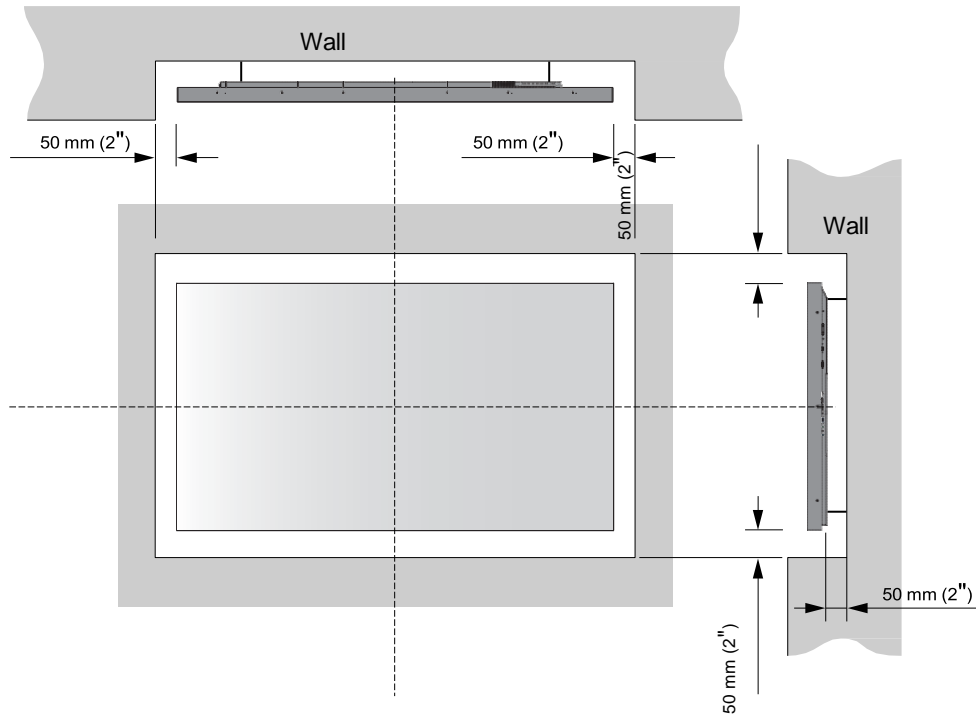

Figure 3-1. Ventilation Requirements for Enclosure Mounting

Mounting the Display

You can mount the display on a wall.

If you do decide to wall-mount the display, ensure that the wall-mount bracket is installed according to the instructions included with it. The wall must be capable of supporting a redundant weight factor three (3) times the weight of the display, or be reinforced.

We recommend that this be done by a custom installation specialist.



NOTE Use only the approved wall-mount kit designed for your display.

Connections to the Display

Proceed as follows to connect the display to your video sources, external controller(s) – if present – and AC power.

When connecting your equipment:

- Turn off all equipment before making any connections.
- Use the correct signal cables for each source.
- For best performance and to minimise cable clutter, use high-quality cables that are only as long as necessary to connect two devices. (Don't use a 7m cable when a 1.8m cable will suffice.)
- Ensure that the cables are securely connected. Tighten the thumbscrews on connectors that have them.

Connecting a Control System or PC:

RS232 Connection

Use a straight-through RS-232 cable with a 9-pin male connector to connect a PC or control/ automation system (if present) to the RS-232 port on the display; see **Figure 3-2**.

For more information about using this connection, refer to **External Control** on page 56.

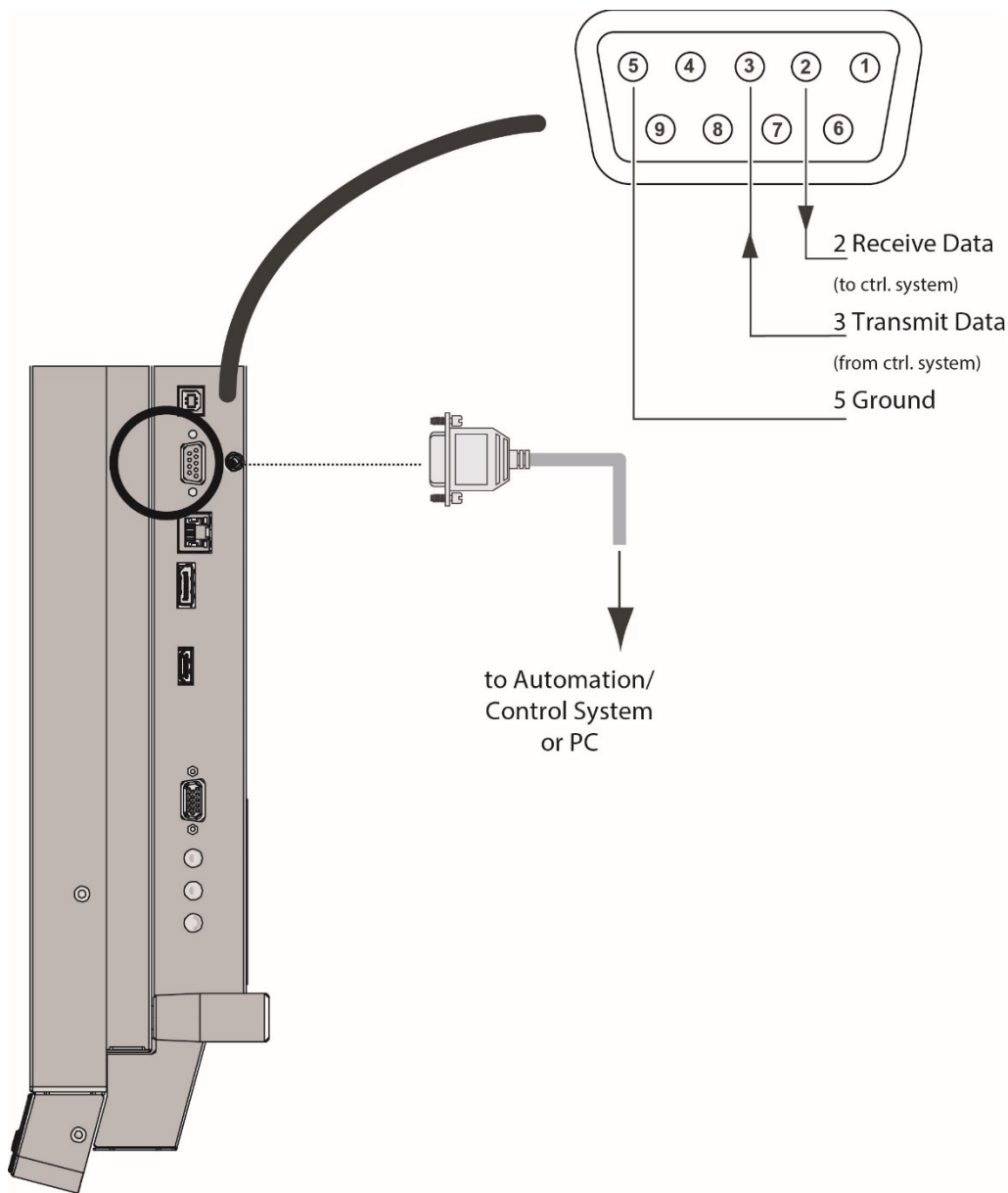

Figure 3-2. RS-232 Control System Connection

Ethernet Connection

Use a standard Ethernet cable with an RJ-45 male connector to connect a PC or control/automation system (if present) to the Ethernet port on the display.

For more information about using this connection, refer to *External Control* on page 56.

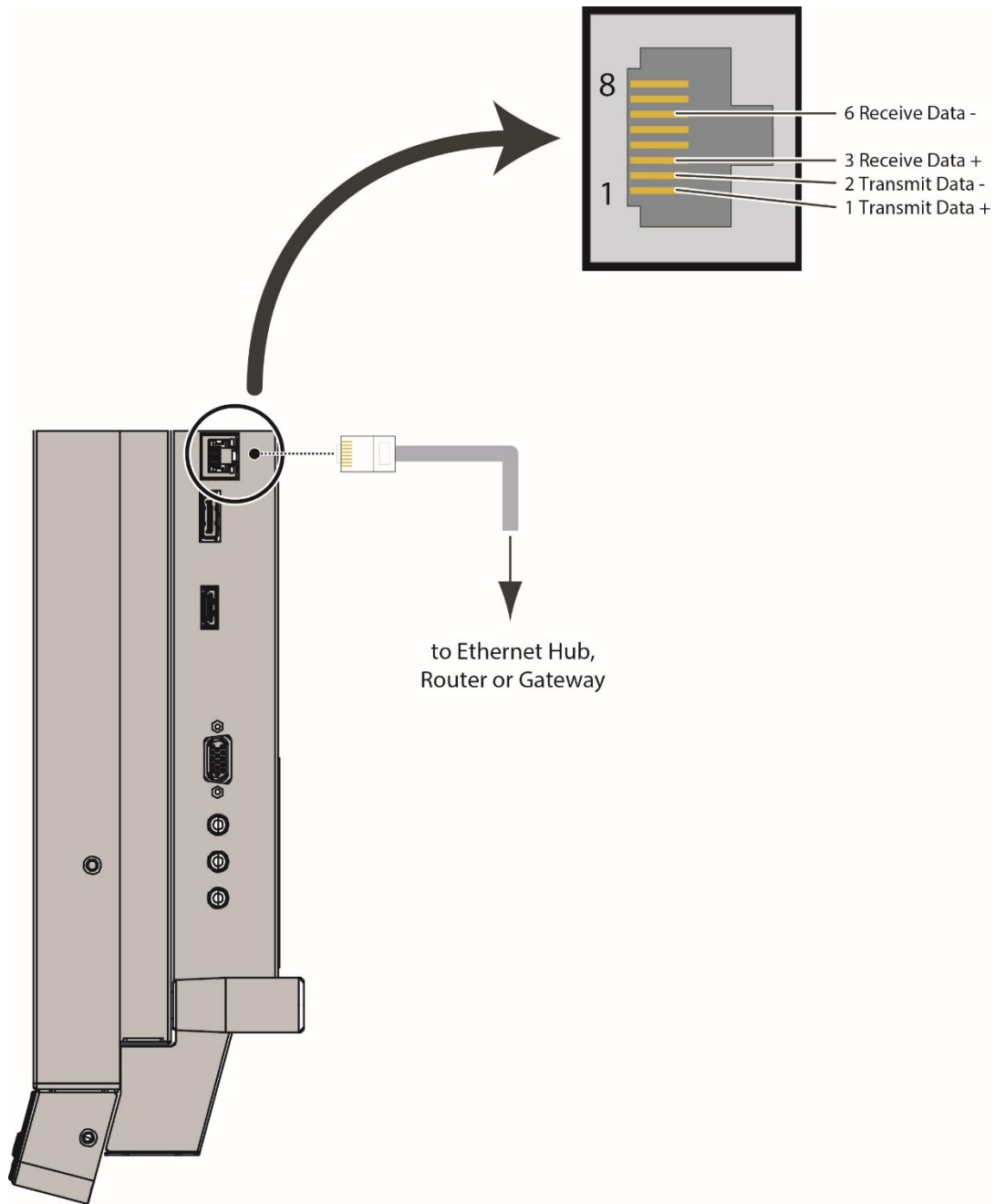

Figure 3-3. Ethernet Connection

Connecting Source Components to the Display

Connect your video sources to the display as shown and described in the sections that follow.

DisplayPort Source Connection: See Figure 3-4.

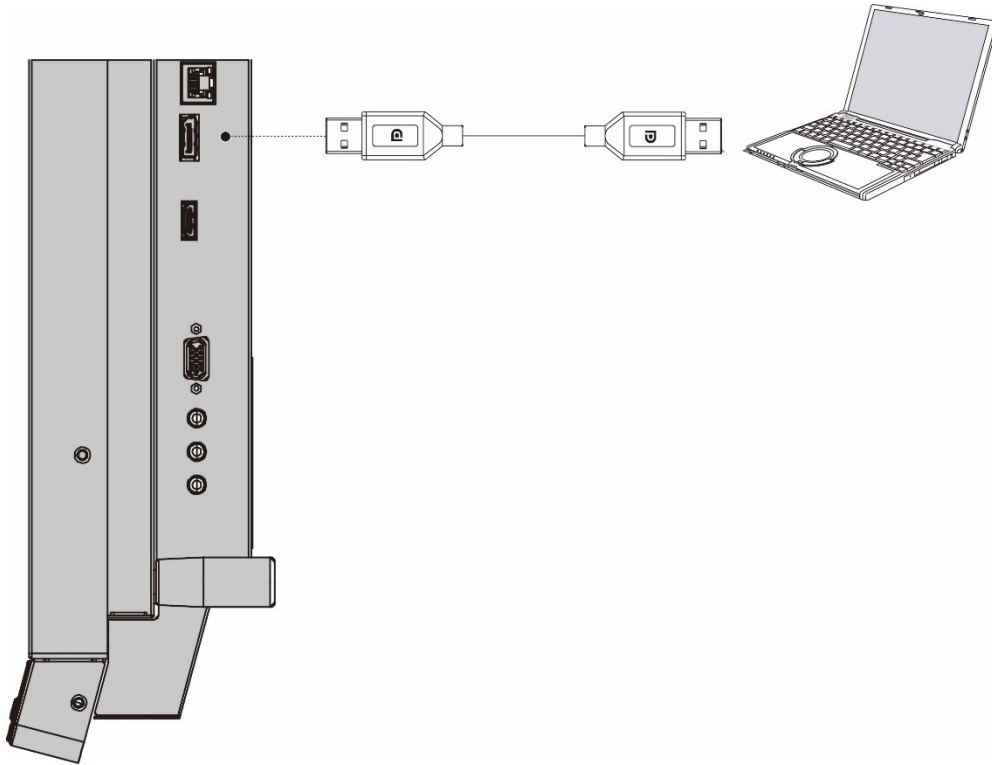

Figure 3-4. DisplayPort Source Connection

HDMI Source Connections: See Figure 3-5.



TIP

Use the HDMI inputs whenever possible. This ensures the highest video quality because the signal is carried in the digital domain throughout the entire signal path, from source component output into the display.



NOTE

This display supports the VESA Display Data Channel (DDC) standard. This standard provides "Plug and Play" capability; the display and a VESA DDC-compatible computer communicate their setting requirements, allowing for quick and easy setup.

For Plug and Play to work correctly, you must turn on the display before you turn on the connected computer.

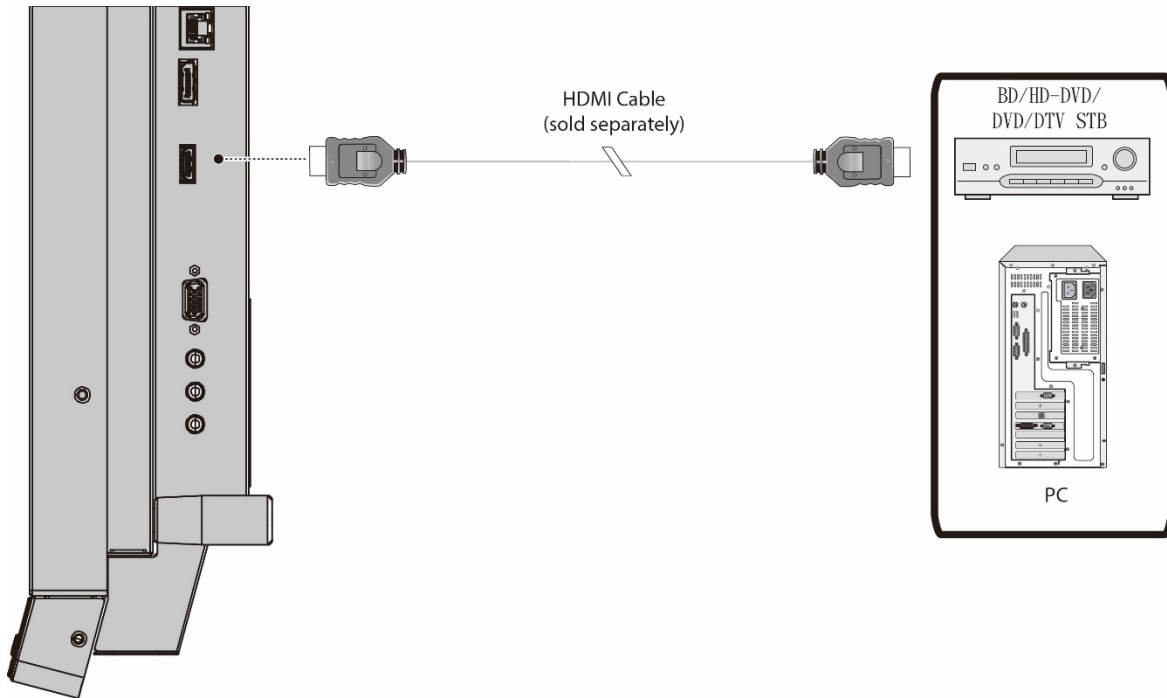

Figure 3-5. HDMI Source Connections

VGA Source Connection:

Connect a personal computer or other RGB source to the VGA input as shown in Figure 3-6.



NOTE Refer to **Supported Timings** on page 69 for a list of compatible input signals.

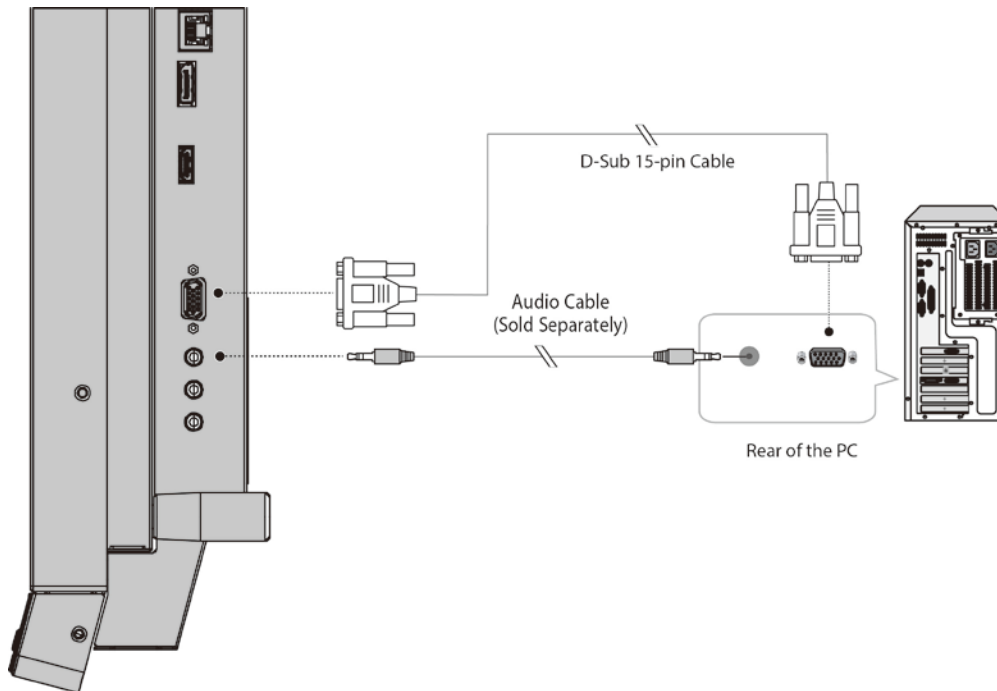



Figure 3-6. VGA Source Connections

Turning on the Power

1. Turn on your source components.
2. Plug the female end of the supplied power cord into the AC receptacle on the side of the display (AC 100V ~ 240V). See Figure 2-2.
3. Connect the other end to your AC power source.
4. Turn on the main power switch at the side of the display (see Figure 2-1). The power indicator lights orange to indicate that the display is in "standby" mode.
5. Press the power button () on the remote control to turn on the display or press the power button () on the keypad.
6. After a brief warm-up period, the display will display an image.



Changing the OSD Language

The display OSD language is initially set to English, but can also display the menus in different languages.

To change the OSD language:

1. Press MENU.
2. Select Basic Settings from the Main Menu.
3. Select OSD Language from the Basic Settings Menu.
4. Press ◀ or ▶ to select the desired language and press ENTER. The change takes effect immediately.

Enabling the Touch Screen

Before setting up your display to support touch screen capability, ensure that:

- The touch screen controller host computer is turned off.
- The display is turned on.
- The video output from the computer is connected to a video input on the display. See Figure 3-4, Figure 3-5 or Figure 3-6.

Connecting the Touch Screen Controller Host Computer to the Display

Use the provided USB cable to connect the touch screen controller host computer to the USB input as shown in Figure 3-7.

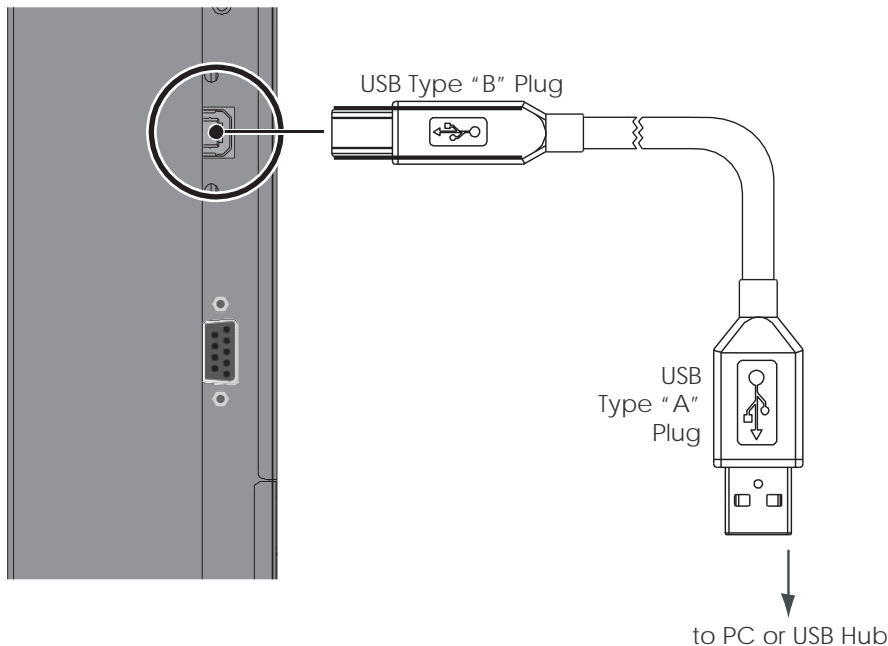

Figure 3-7. Touch Screen Controller (USB) Connection

After (and **only** after) making this connection, turn on your host computer.

Software Installation

This driver is not needed for any touch functionality, but is needed in order to perform firmware upgrade.

Automatic Driver Installation

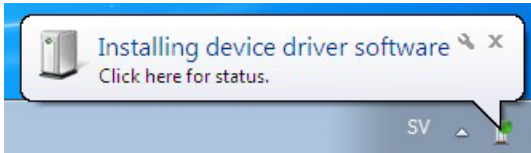

If the automatic driver installation starts, please allow it to run until completion in order to not disrupt the automatic process. Note that the icon may be hidden in the notification area, and that the procedure may take several minutes.

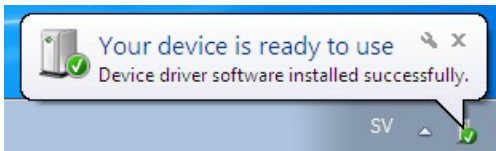

Clicking on the pop-up balloon at this point would show

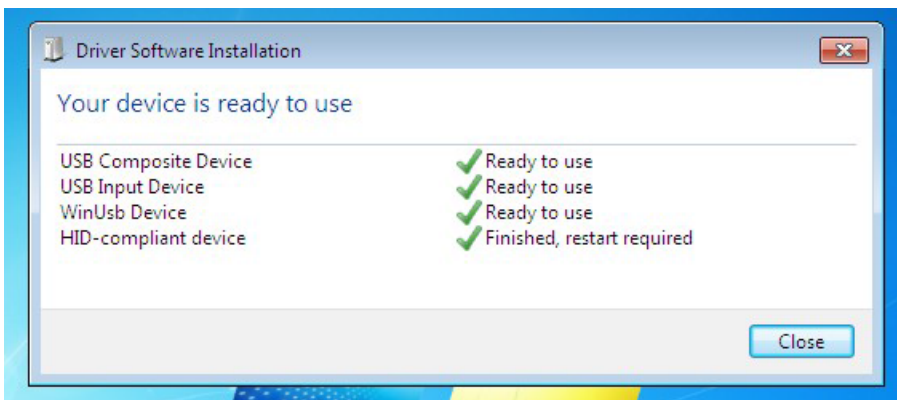

Fully expanded, the view in the Device Manager should look like this (View --> Devices by connection):

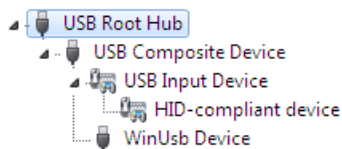

If the automatic installation fails to find the driver, or if automatic driver installation is disabled, or if there is no Internet connection, this is what you will typically see when connecting a FlagFrog touch device.

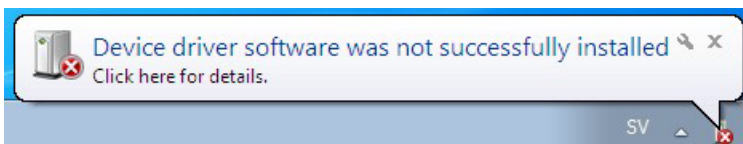

Clicking on the pop-up ballo would show

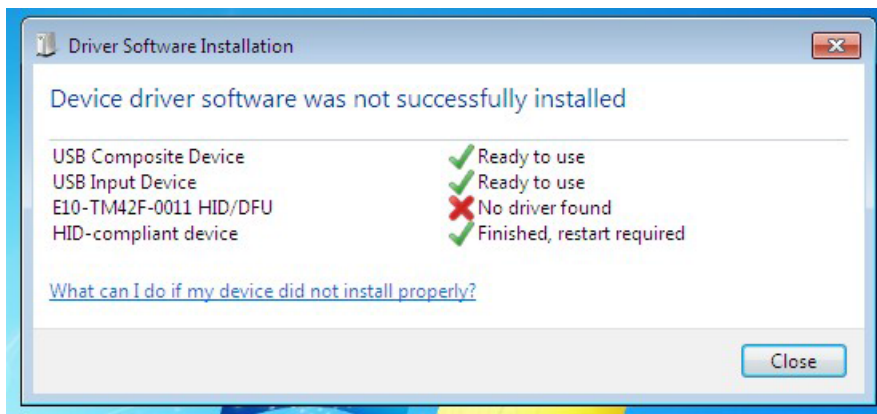

In the Device Manager, the view would be (again, use View --> Devices by connection):

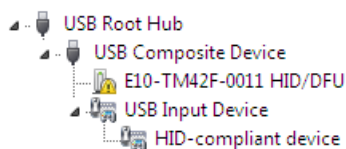

In this case, please proceed with Manual Driver Installation.

Manual Driver Installation

If the automatic driver installation failed for any of the reasons listed above, or if you would like to install the driver without having a FlatFrog touch device connected to the computer, the driver can be installed manually.

The driver provided with this upgrade package was downloaded from <http://catalog.update.microsoft.com> (requires Internet Explorer) and is called "Microsoft – Other hardware – WinUsb Device" (version 1.1.0.0 from 2012-08-30).

Manual Driver Installation - Device Connected

1. Extract the firmware upgrade .zip file (right-click --> Extract all...) to the Desktop.
2. Open the Device Manager and locate the "HID/DFU" device with the yellow exclamation mark.
3. Right-click and select "Update Driver Software..."

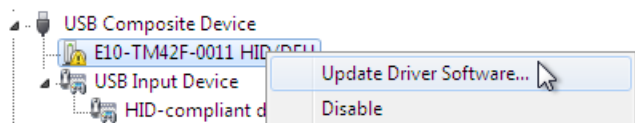

4. Select "Browse my computer for driver software" and select the extracted folder from step 1 and follow the instructions.

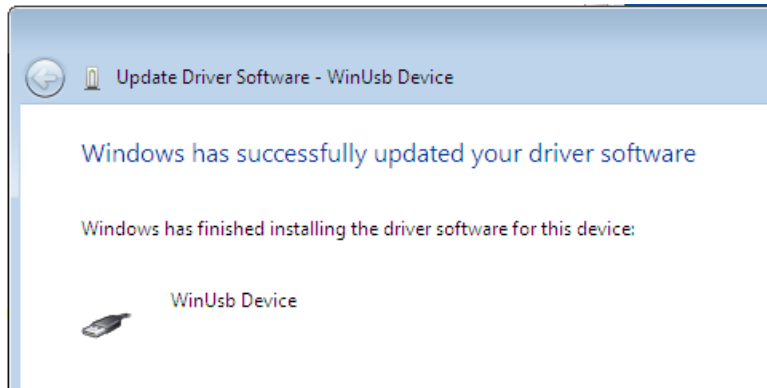

5. If step 4 was unsuccessful, then Windows failed to automatically associate the driver with the device.

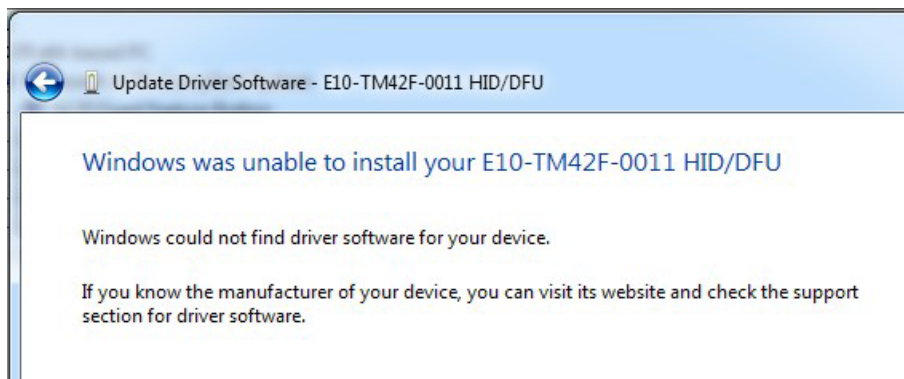

6. Choose "Let me pick from a list if device drivers on my computer" in step 4, scroll all the way down to "Universal Serial Bus devices" and click Next.

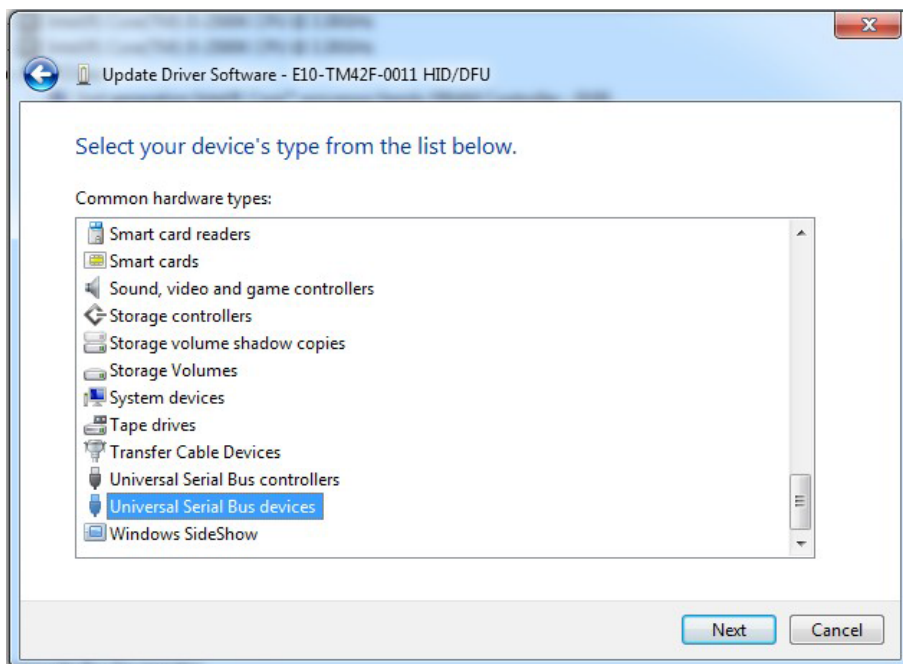

7. Select the WinUsb device driver, and click Next. (If the WinUsb device driver is not in the list, please follow the steps under "Manual Driver Installation - Device Not Connected" first).

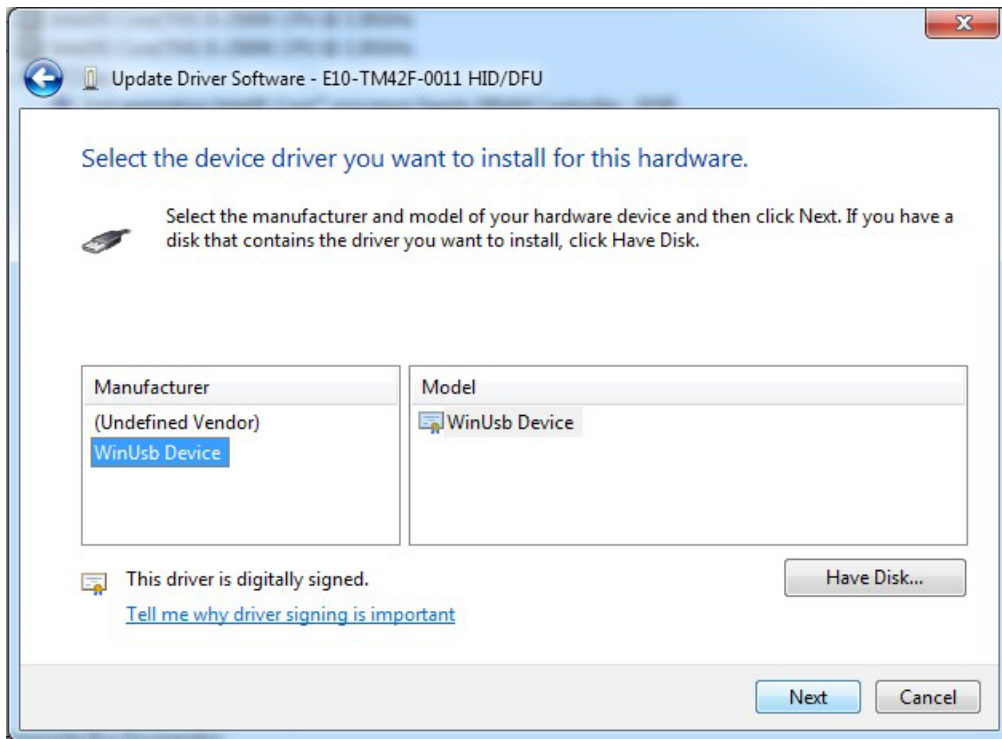

Manual Driver Installation - Device Not Connected

1. Extract the firmware upgrade .zip file (right-click --> Extract all...) to the Desktop.
2. Navigate to the "support" folder.
3. Right-click on the **install_driver.bat** file and select "Run as administrator" and follow the instructions.

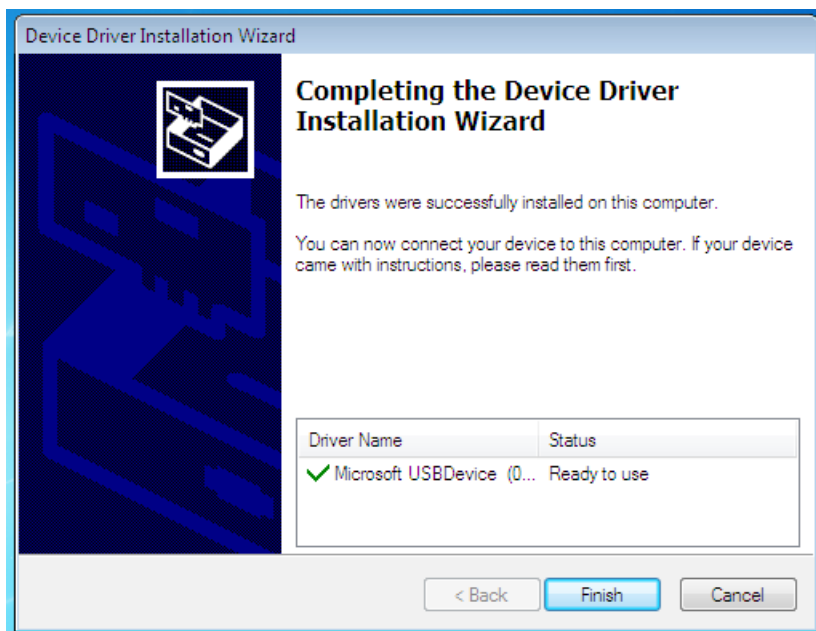

4. Operation

Using the On-Screen Menus

To display the on-screen menus, press MENU on the remote control (Figure 2-3) or built-in keypad (Figure 2-1).

To select a sub-menu, use the ▲ and ▼ buttons to highlight it. Then, press ► to enter that sub-menu.

To select a menu item, use the ▲ and ▼ buttons to highlight it. Then, press ◀ or ▶ to adjust that setting and press ENTER.

The OSD menus are arranged hierarchically, as shown in Figure 4-1. Depending on the selected input source and signal characteristics, some menu options may not be available.

Video Settings	Scheme (Video Mode)	User, Vivid, Cinema, Game or Sport		
	Brightness	0, 1, 2 ... 50 ... 99, 100		
	Contrast			
	Sharpness (Video Mode)	0, 1, 2 ... 6 , 7, 8		
	Saturation (Video Mode)	0, 1, 2 ... 50 ... 99, 100		
	Hue			
	Backlight	0, 1, 2 ... 80 ... 99, 100		
	Colour Temperature & Gamma	Gamma	Off or 2.2	
		Colour Temperature	5000K, 6500K, 7500K, 9300K or User	
		Red / Green / Blue Gain	128, 129, 130 ... 256 ... 382, 383	
		Red / Green / Blue Offset	-50, -49, -48 ... 0 ... 48, 49, 50	
	HDMI Color Range	Auto, Full, Limited		
	Aspect Ratio	Full Screen , Pillar Box or Auto		
Auto Scan	On or Off			
Select Source	VGA , HDMI, or DisplayPort			
Audio Settings	Volume	0, 1, 2 ... 50 ... 99, 100		
	Bass	-6, -5, -4 ... 0 ... 5, 6		
	Treble			
	Balance			
	HDMI Audio Input	HDMI or PC Audio		
	DP Audio Input	DisplayPort or PC Audio		
	Internal Speakers	Off or On		
Basic Settings	OSD Transparent	0 , 1, 2 ... 6... 12		
	OSD Location	Up, Down, Left, Right		
	OSD Rotation	Portrait / Landscape		
	OSD Language	English, German, Dutch, French, Croatian, Danish, Serbian, Slovenian, Hungarian		
	OSD Timeout	5, 10, 15 ... 30 ... 115, 120 seconds		
	Power LED	On or Off		

Basic Settings	Real Time Clock	Current Date and Time		
		Timer Mode	User / Work Days / All Days	
		Power-On	Disable or Enable	
		Power-Off		
	Start Up Logo	On or Off		
Rename Source	Rename input sources	Up to 8 characters: 0-9, A-Z, a-z.		
Advanced Settings	Auto Adjustment (Video Mode)	Off or On		
	Image Position (Video Mode)	Up, Down, Left, Right -50, ... 0, ...50		
	Phase (Video Mode)	0, 1, 2 ... 63		
	Clock (Video Mode)	0, 1, 2 ... 100		
	USB Touch Mode	Auto, USB Touch 1, USB Touch 2, PC		
	IRFM	Off or On		
	Baud Rate	115200 , 38400, 19200 or 9600		
	Smart Light Control	Off , DCR or Light Sensor		
	Wake Up from Sleep	VGA Only / VGA, Digital, RS232 / Never Sleep		
	Ethernet Setup	Enable network		No or Yes
		Dynamic IP		Disable or Enable
		Static IP		255.255.255.255 (0.0.0.0)
		Subnet Mask		255.255.255.255 (0.0.0.0)
		Gateway		255.255.255.255 (0.0.0.0)
		DNS Address		255.255.255.255 (0.0.0.0)
		Save Network Settings		No or Yes
		Refresh		Refreshes dynamic IP information
		Power Status Alert		No or Yes
		Source Status Alert		No or Yes
		Signal Status Alert		No or Yes
		Load Default		Loads default network settings
		Device MAC		Displays MAC information
	Win10 PC Power Mode	Win10 PC power model selection	Auto , Manual, Off	
Factory Reset	Yes or No			
System	Channel Information	Main	Active Source / Signal Resolution / Refresh Rate / PC Power Status	
	Firmware Version	Information of the firmware version		
	SN	Information of the serial number		



NOTE

Default settings appear in bold type.

Figure 4-1. OSD Menu Structure

Video Settings



Use the controls in the Video Settings Menu to calibrate each display input to achieve optimum picture quality. Connect your test pattern source to the input that you are calibrating and proceed as follows.

Perform the adjustments in the order listed here.

Scheme:

Select Scheme from the Video Settings menu, then press ◀ or ▶ to select one of four image quality presets (Vivid, Cinema, Game or Sport) depending on the type of program material you are viewing. These presets automatically adjust the other image settings for optimal image quality. Or, select User to adjust Brightness, Contrast and other settings manually.

Brightness:

On your external test pattern source, select a PLUGE pattern. (PLUGE is an acronym for "Picture Line-Up Generation Equipment.") Figure 4-2 shows a typical PLUGE pattern.

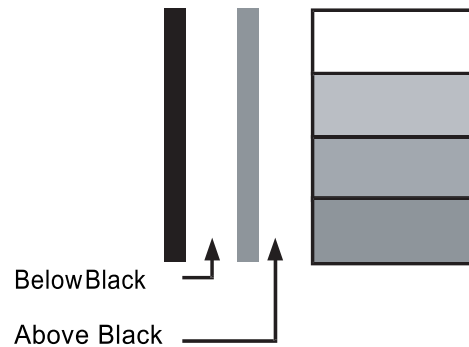

Figure 4-2. Typical PLUGE Pattern for Adjusting Brightness

PLUGE patterns vary but generally consist of some combination of black, white and grey areas against a black background. The example above includes two vertical bars and four shaded boxes.

Select Brightness from the Video Settings menu and press ◀ or ▶ to adjust the brightness so that:

- The darkest black bars disappear into the background.
- The dark grey areas are barely visible.
- The lighter grey areas are clearly visible.
- The white areas are a comfortable level of true white.
- The image contains only black, grey and white (no colour).

Contrast:

On your external test pattern source, select a stepped, grey-bar pattern like the one shown in Figure 4-3.



Figure 4-3. Typical Grey Bar Pattern for Adjusting Contrast

Select Contrast and press ◀ or ▶ to adjust the contrast to a point just below which the white rectangle starts to increase in size.



NOTE *Brightness and contrast controls are interactive. A change to one may require a subtle change to the other to achieve the optimum setting.*

Sharpness:

“Sharpness” is the amount of high-frequency detail in the image. To adjust sharpness, select Sharpness from the Video Settings menu. On your external test pattern source, select a pattern like the one shown in Figure 4-4. Adjust as needed, looking for white edges around the transitions from black to grey and differently-sized lines in the “sweep” patterns at the top and bottom. Lower the sharpness setting to eliminate them.

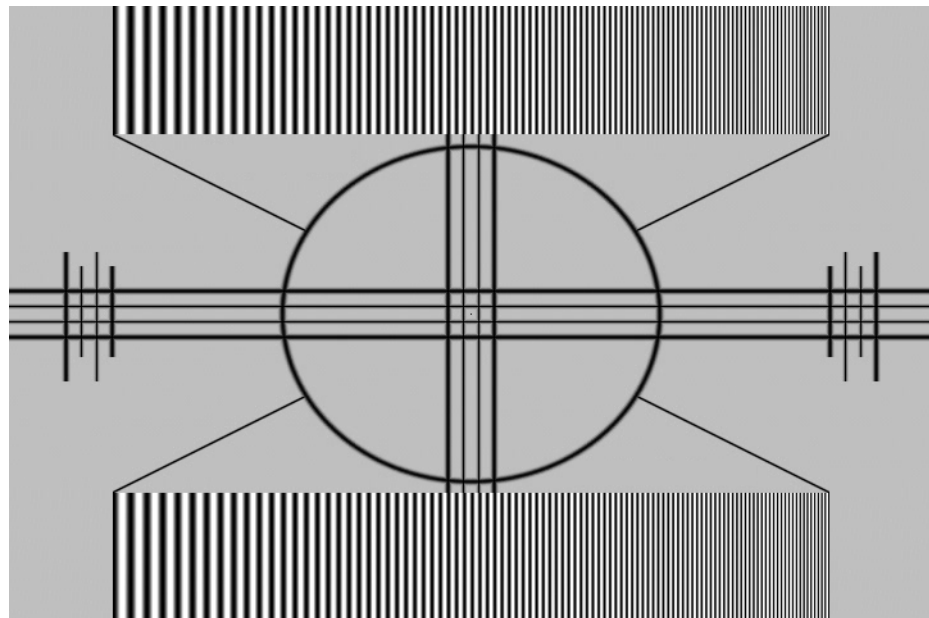

Figure 4-4. Typical Test Pattern for Adjusting Sharpness

Saturation:

On your external test pattern source, select a colour bar pattern like the one shown in Figure 4-5.

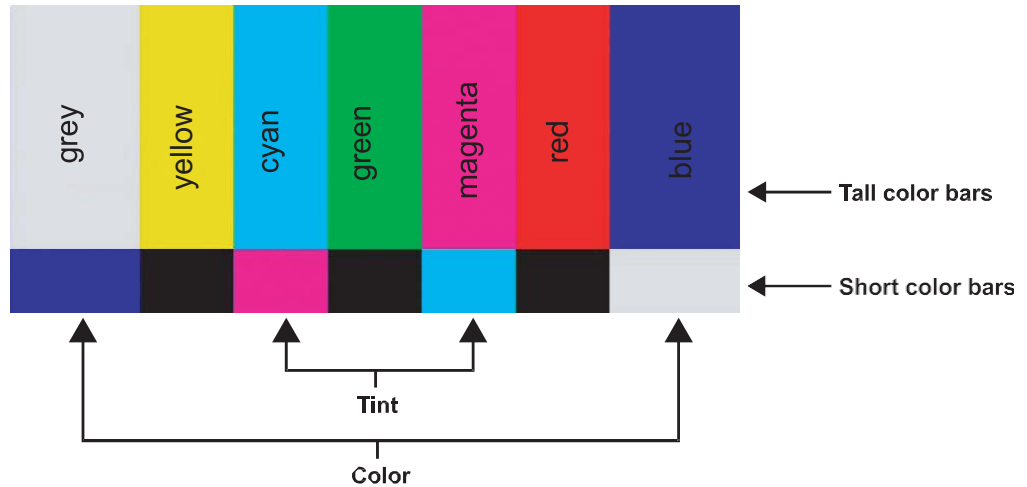
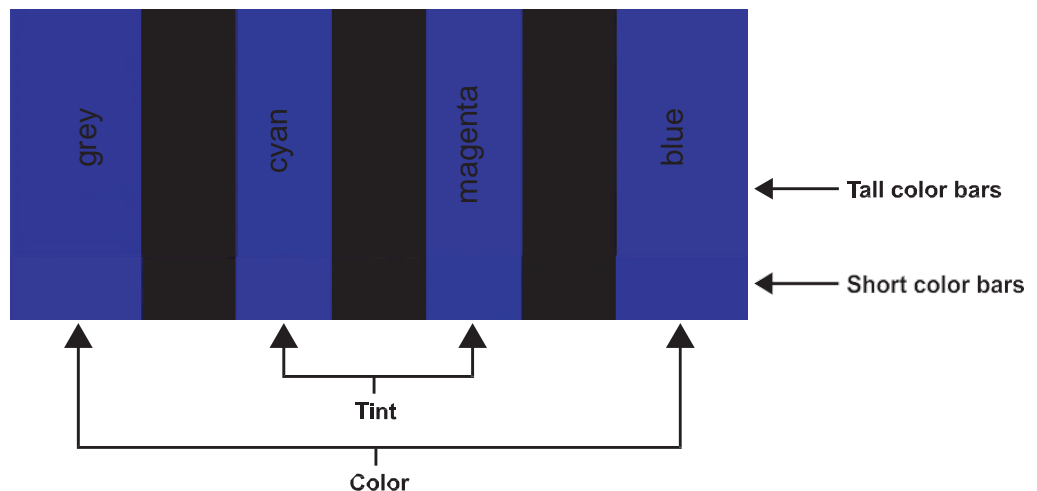

Figure 4-5. Typical Colour Bar Pattern for Adjusting Colour Saturation and Hue

Press MENU on the remote control or keypad. Select Saturation from the Video Settings menu. While looking at the colour bar pattern through a blue filter, adjust the colour saturation level until the outermost (grey and blue) colour bars appear to be a single shade of blue:



Hue:

“Hue” (or “tint”) is essentially the ratio of red to green in the colour portion of the image. When hue is decreased, the image appears redder; when it is increased the image appears greener.

To adjust the hue, use a blue filter when viewing the colour bar pattern, as you would for adjusting colour saturation (refer to the previous section, Saturation).

Select Hue from the Video Settings menu and press ◀ or ▶ to adjust it until the cyan and magenta colour bars (on either side of the green bar) appear to be a single shade of blue.



NOTE

Like the brightness and contrast controls, the colour and tint controls are interactive. A change to one may require a subtle change to the other to achieve the optimum setting.

Backlight:

The Backlight control changes the apparent brightness of the displayed image. Its effect is similar to that of a lamp intensity control on a projector.

Gamma:

Select Gamma from the Video Settings menu and choose either 2.2 (default) or Off.

Colour Temperature:

Select Colour Temperature from the Video Settings menu to adjust the colour temperature. Colour temperature establishes the "colour of grey" by adjusting the 75% white point to various colour points.

- **What are "colour points?"**

A "colour point" is an x/ y coordinate pair that defines a colour's location on the standard CIE chromaticity graph, shown in Figure 4-6. (CIE stands for "Commission Internationale de l'Éclairage" (International Commission on Illumination), the organisation responsible for colour measurement and management standards.)

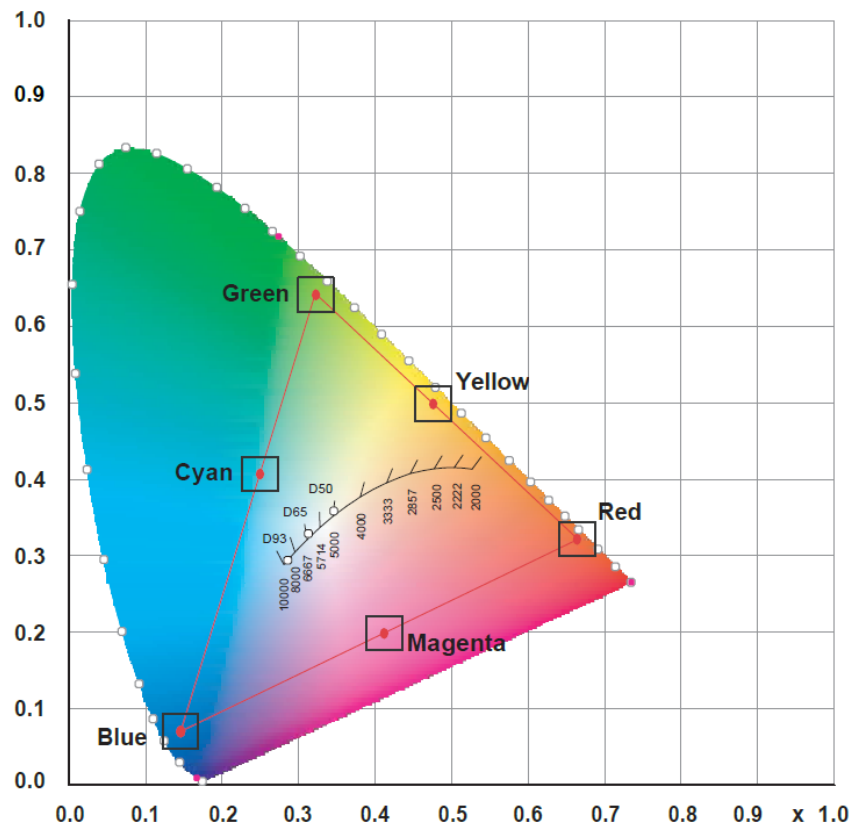

Figure 4-6. CIE 1931 Chromaticity Diagram

Select a value of from 3200K to 9600K. Higher settings produce a "bluer" picture; lower ones impart a reddish hue to the image. To select a custom colour temperature, select User and set the Gain and Offset as described below.

- **Gain:** Use the Gain controls to correct colour imbalances in the bright areas of the image. A good way to do this is to use a test pattern consisting mostly of solid white areas, such as an 80 IRE " window " pattern. If the white areas contain traces of red, green or blue, decrease the Gain for that colour.

- **Offset:** Use the Offset controls to correct colour imbalances in the dark areas of the image. A good way to do this is to use a test pattern consisting mostly of dark grey areas, such as a 30 IRE " window " pattern. If the grey areas contain traces of red, green or blue, decrease the Offset for that colour.

HDMI RGB Colour Range:

Select an RGB range for the HDMI input, from one of the options: Auto, Full or Limited.

Aspect Ratio:

To change the aspect ratio (size and shape) of the displayed image, select Aspect Ratio from the Video Settings menu and press ENTER. Select the appropriate aspect ratio for the type of program material being viewed.

Note that some aspect ratios are unavailable and/or not useful with certain types of source material. The optimal setting depends on a number of factors, such as:

- The aspect ratio of the source material, as broadcast or encoded on the playback medium.
- The "display type" (16:9 or 4:3) and output resolution settings at the source component. Most modern DVD/BD players and set-top boxes have such controls.
- Viewer preference (original aspect ratio with "black bars," or a full-screen presentation with some distortion or cropping).

Auto Scan:

Select Auto Scan from the Video Settings menu and press ◀ or ▶ to turn this feature on or off. When set to On, Auto Scan causes the input select function (using the SOURCE button on the remote control unit or keypad) to skip over unused inputs, saving time.

Select Source:

Choose Select Source from the Video Settings menu and press ◀ or ▶ to select the video source.

Audio Settings

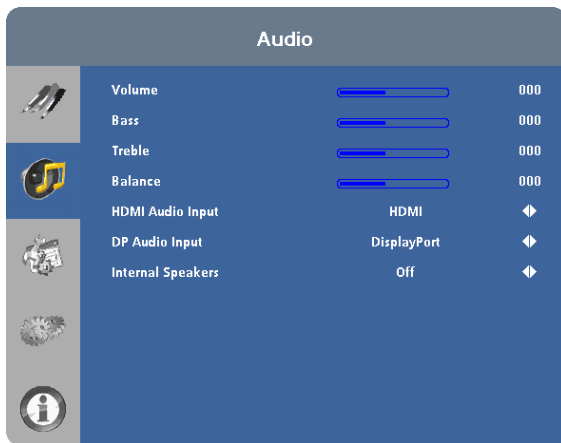

Volume:

Select Volume from the Audio Settings menu and press ◀ or ▶ to change the audio volume.

Bass:

Select Bass from the Audio Settings menu and press ◀ or ▶ to cut or boost the low audio frequencies.

Treble:

Select Treble from the Audio Settings menu and press ◀ or ▶ to cut or boost the high audio frequencies.

Balance:

To adjust the left/right speaker balance, select Balance from the Audio Settings menu and press ◀ or ▶ to make one channel louder than the other.

HDMI Audio Input:

If you are using one of the HDMI inputs with a PC or other device that does not support audio output via HDMI, set HDMI Audio Input to PC for that input. (Also connect the audio output from your source as shown in Figure 3-5.) This setting associates the PC Audio In input with that HDMI input.

DP Audio Input:

If you are using the DisplayPort input with a PC or other device that does not support audio output via DisplayPort, set DP Audio Input to PC for that input. (Also connect the audio output from your source as shown in Figure 3-5.) This setting associates the PC Audio In input with the DisplayPort input.

Internal Speakers:

Set Internal Speakers to Off to disable the internal speakers on the display. Set it to On to enable them.

Basic Settings

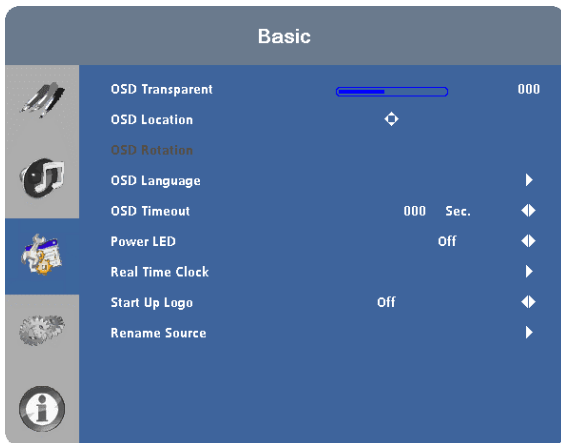

OSD Transparent:

Select OSD Transparent from the Basic Settings menu and press ◀ or ▶ to adjust the degree of translucence (show-through) in the menus and message boxes. Zero (0) means that the menus are opaque.

OSD Location:

Select OSD Location from the Basic Settings menu and press ◀ or ▶ to move the OSD menu to the desired location.

OSD Rotation:

Select OSD Rotation from the Basic Settings menu and press ◀ or ▶ to change the orientation of the OSD menu to match that of the display.

OSD Language:

Select OSD Language from the Basic Settings menu and press ◀ or ▶ to select the OSD Language.

OSD Timeout:

Select OSD Timeout from the Basic Settings menu to specify how long the menus remain on-screen after selecting them. Select from 5 to 120 seconds, in five-second increments.

Power LED:

Select Power LED from the Basic Settings menu to change the behaviour of the status indicator LED (see Figure 2-1) during standby mode. When set to On, the LED lights orange to indicate that the display is in standby mode. When set to Off, the LED is always off, regardless of the operational state of the display.

Real Time Clock:

Select Real Time Clock from the Basic Settings menu to set the display's internal real-time clock.

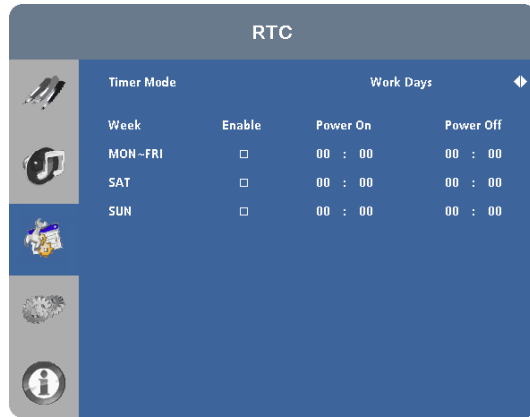
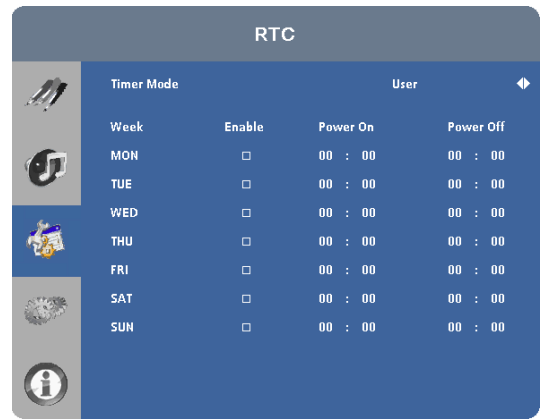
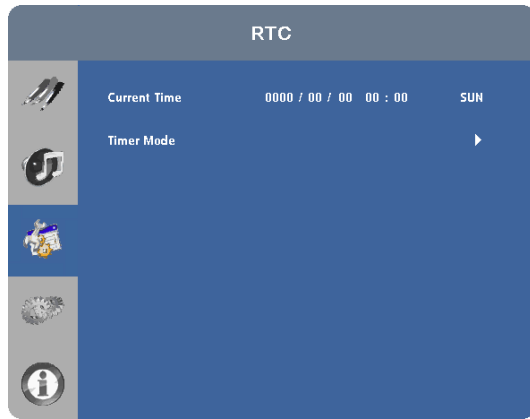

From this menu, you can also program the display to turn on and off at specified times of day and days of the week:

- To set power-on and power-off times for each day of the week independently, set the Timer Mode to User.
- To set the same power-on and power-off times for every day of the week, set the Timer Mode to All Days.
- To set the same power-on and power-off times for Monday through Friday, set the Timer Mode to Work Days.

Rename Source:

Rename the input source. Press ENTER to select the input source you want to rename. Using ▲ or ▼ to change the character and ◀ or ▶ to move forward/back a position. Then press MENU and ENTER to save the name. The name can be up to eight characters (0~9, A~Z, a~z).

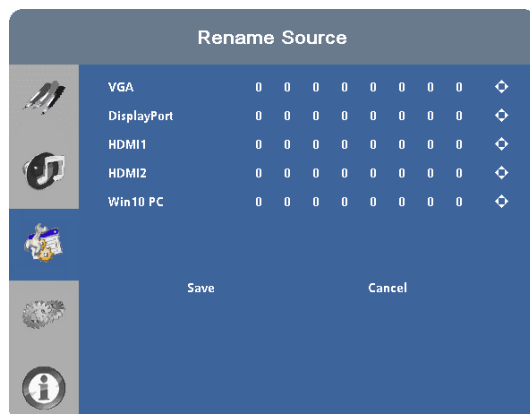

Advanced Settings

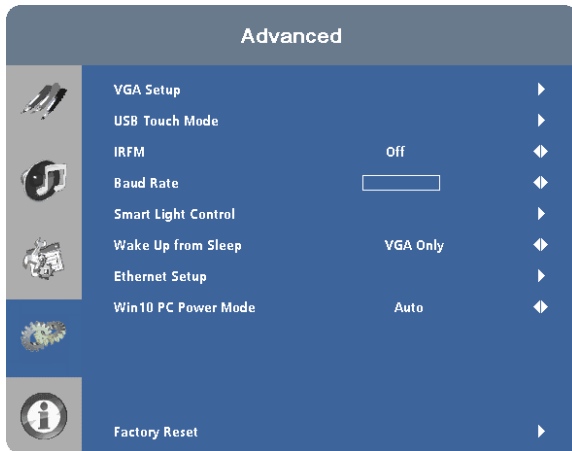

VGA Setup:

This option is only available when connected to a VGA input; while connected, you can access the following settings.

- **Auto Adjustment:** Select Auto Adjustment from the Advanced Settings menu to force the display to reacquire and lock to the input signal. This is useful when the signal quality is marginal.
- **Image Position (VGA sources):** Use the controls in the Image Position (VGA sources) Menu to fine-tune the image position.
 - Left/Right: Select Left/Right from the Input Position menu to shift the projected image horizontally. Press ► to shift the image to the right; press ◀ to shift it to the left.
 - Up/Down: Select Up/Down from the Input Position menu to shift the projected image vertically.
- **Phase (VGA sources):** This control adjusts the phase of the pixel sampling clock relative to the incoming signal. Adjust the phase when an image still shows shimmer or “noise” after the Clock setting has been optimised.



TIP Adjust the Phase after adjusting Clock (see below).

For best results, use a good test pattern such as a smooth grey consisting of a clear pattern of black and white pixels, or a similar “half on, half off” graphic image. Adjust the slider until the image stabilises and each pixel is clearly defined. You may notice that you can stabilise the image at more than one point. Use either setting in such cases.

- **Clock (VGA sources):**

This control sets the frequency of the pixel sampling clock, indicated by the number of incoming pixels per line, so that all pixels generated by a particular source are sampled. Steady flickering or several soft vertical stripes or bands across the entire image indicates poor pixel tracking. Proper pixel tracking helps ensure that the image quality is consistent across the screen, that aspect ratio is maintained and that pixel phase (see above) can be optimised.

USB Touch Mode:

Select the USB touch connector to connect a touch screen controller from one of the options: Auto, USB Touch 1 (located at front panel), USB Touch 2 (located on I/O panel), PC.

IRFM:

Select IRFM from the Advanced Settings menu and press ◀ or ▶ to enable or disable this feature, which creates slight frame motion to help avoid image retention.

Baud Rate:

Select Baud Rate from the Advanced Settings menu and press ◀ or ▶ to set the data rate of the RS-232 communication link.

Smart Light Control:

Select Smart Light Control from the Advanced Settings menu and press or to configure the automatic backlight control feature of the display. Select one of the following, or select Off to control the backlight level manually with the Backlight control in the Video Settings menu.

- **Light Sensor:** With this setting, the backlight level is controlled by the display's internal ambient light sensor.
- **DCR:** With this setting, the display automatically adjusts the backlight level according to the amount of contrast and brightness in the source material.

Wake Up From Sleep:

Select Wake Up From Sleep from the Advanced Settings menu and press ◀ or ▶ to control this feature, which operates as follows:

- **VGA Only:** The display normally wakes up from power-saving mode when it receives an active video signal on its VGA (analog) input.
- **VGA, Digital, RS232:** The display wakes up when it receives an active signal from its VGA, HDMI or DisplayPort inputs, or receives a valid RS-232 command.
- **Never Sleep:** The display never enters power-saving mode.

Ethernet Setup:

Select Ethernet Setup from the Advanced Settings menu and press ▶ to configure the display's network settings.



- **Enable Network:** Enables the network feature. Option: No, Yes.
- **IP Address Settings:** When network feature is enabled, press ▶ to configure the following IP addresses:
 - **Dynamic IP:** Enable DHCP for dynamic IP address assignment.
 - **Static IP Address:** Sets the static IP address when the DYNAMIC IP line is disabled or views it when the DYNAMIC IP line is enabled.
Range: 255.255.255.255 (0.0.0.0)

- **Subnet Mask:** Sets the subnet mask when the DYNAMIC IP line is disabled or views it when the DYNAMIC IP line is enabled.
Range: 255.255.255.255 (0.0.0.0)
 - **Gateway:** Sets the gateway address when the DYNAMIC IP line is disabled or views it when the DYNAMIC IP line is enabled.
Range: 255.255.255.255 (0.0.0.0)
 - **DNS Address:** Sets the DNS address when the DYNAMIC IP line is disabled or views it when the DYNAMIC IP line is enabled.
Range: 255.255.255.255 (0.0.0.0)
 - **Save Network Settings:** Saves the network configuration when the DYNAMIC IP line is disabled. Options: No, Yes.
 - **Refresh:** Refreshes the configuraiton of Static IP Address, Subnet Mask, Gateway and DNS Address.
- **Power Status Alert:** sent when the unit is turned on or off.
 - **Source Status Alert:** sent when a different source is selected.
 - **Signal Lost Alert:** sent when the input sync is lost.
 - **Load Default:** loads default network settings. Options: No, Yes
 - **Device MAC:** Shows the unique address assigned to network interfaces.

Factory Reset:

To reset ALL display settings (including image settings) back to their factory defaults, choose Factory Reset from the Advanced Settings menu.

A confirmation message appears. Select Yes to continue with the reset or select No to cancel.



CAUTION *This action is not reversible. Proceed with caution!*

Win10 PC Power Mode:

Set Win10 PC Power Mode to Auto, Manual or Off. The power mode is defaultly set to Auto.

System

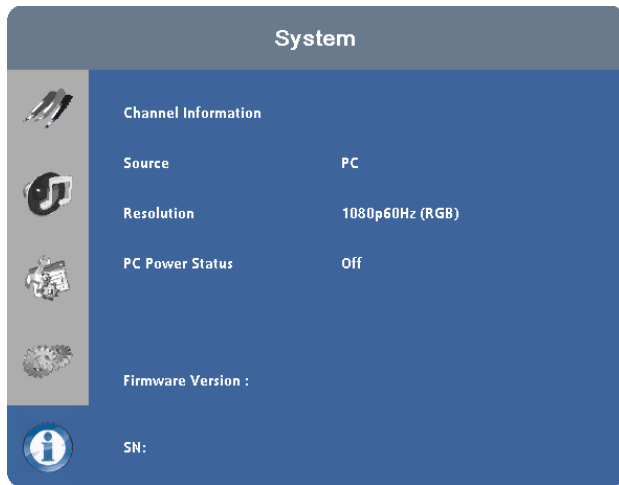

The read-only System menu provides the following status information about the display:

- Currently connected input source
- The resolution and refresh rate of the active source
- The power status of PC
- The currently-installed firmware version
- Serial number of the display

5. Maintenance and Troubleshooting

Maintenance

The AVOCOR Series LED Displays does not require any routine maintenance other than occasional cleaning with a non-abrasive cloth. There are no user-serviceable or replaceable parts. Unless you are a qualified, factory-trained technician, do not attempt to repair or replace any system component yourself. You will void the product warranty if you do so.

Troubleshooting

Table 5-1 provides some general guidelines for troubleshooting problems you may encounter with the AVOCOR Series LED Display. If the suggested solutions fail to resolve the problem or if you encounter an issue not described here, please contact your dealer.

Table 5-1. Troubleshooting Chart

Symptom	Possible Cause(s)	Solution
The display does not turn on.	<ul style="list-style-type: none"> The display is not plugged in or the AC outlet is not active. The main power switch is off. The remote control batteries have run out. 	<ul style="list-style-type: none"> Ensure that the display is plugged in and that the AC outlet is active. Set the main power switch (see Figure 2-1) to the on position. Replace the batteries.
The display is on and menus appear, but there is no picture.	<ul style="list-style-type: none"> Incorrect source selection. Source component is not turned on. Source component is connected incorrectly or not at all. 	<ul style="list-style-type: none"> Select the correct source. Turn on the source component. Check connections from the source component to the display.
The remote control does not work.	<ul style="list-style-type: none"> The remote control batteries have run out. The buttons are locked. 	<ul style="list-style-type: none"> Replace the batteries. Unlock the buttons by pressing ENTER, ENTER, EXIT, EXIT, ENTER, EXIT in sequence.
Image geometry is incorrect.	<ul style="list-style-type: none"> Incorrect aspect ratio selection. 	<ul style="list-style-type: none"> Select a different aspect ratio.

Table 5-1. Troubleshooting Chart (continued)

Symptom	Possible Cause(s)	Solution
The display is jittery or unstable.	<ul style="list-style-type: none"> • Poor-quality or improperly connected source. • The horizontal or vertical scan frequency of the input signal may be out of range for the display. 	<ul style="list-style-type: none"> • Ensure that the source is properly connected and of adequate quality for detection. • Correct at the source.
Image is too bright and/or lacks definition in the bright areas of the image.	<ul style="list-style-type: none"> • Contrast is set too high. 	<ul style="list-style-type: none"> • Decrease the contrast setting.
Image appears “washed out” and/or dark areas appear too bright.	<ul style="list-style-type: none"> • Brightness is set too high. 	<ul style="list-style-type: none"> • Decrease the brightness setting.
Image is too dark.	<ul style="list-style-type: none"> • Brightness and/or Backlight are set too low. 	<ul style="list-style-type: none"> • Increase the brightness and/or backlight settings.
Images from an HDMI source do not display.	<ul style="list-style-type: none"> • The resolution and frequency of the video card in the computer are not compatible with the display. • HDMI cable from source to display is either defective or too long. 	<ul style="list-style-type: none"> • Select a compatible resolution and vertical frequency (refer to Supported Timings on page 69). • Try a known-good and/or shorter HDMI cable.
Computer images do not display correctly.	<ul style="list-style-type: none"> • The resolution and frequency of the video card in the computer are not compatible with the display. • Clock and Phase settings need adjustment. 	<ul style="list-style-type: none"> • Select a compatible resolution and vertical frequency (refer to Supported Timings on page 69). • Adjust Clocks and Phase settings (refer to Phase - VGA sources on page 49 and Clock - VGA sources on page 49).
Touch screen doesn't work.	<ul style="list-style-type: none"> • Multi-touch controller host computer is not connected correctly. • Host computer hardware or OS incompatibility. 	<ul style="list-style-type: none"> • See Figure 3-7. • Refer to Enabling the Touch Screen on page 34.

Should you require assistance with a suspected hardware fault, please contact the support line below. You will require your unit serial number. The operator will attempt to diagnose any fault and will take action as appropriate.

avocorTM

US Warranty Support

Tel. 858-266-8363

Email. service@avocor.com

6. External Control

In addition to using the display keypad or remote control unit, you can control the display using a serial (RS-232) link to send ASCII commands and receive responses to those commands.

You also use discrete infrared (IR) control codes to program a third-party remote control unit. For more information, refer to Using Discrete IR Codes on page 64.

Serial Communications

The display uses a simple text-based control protocol to take requests from control devices and to provide responses to such devices. This section describes how to send control messages over a serial link between the display and an automation/control system or a PC running a terminal emulation program such as Windows® HyperTerminal or Tera Term.

RS-232 Connection and Port Configuration

Connect your control system or PC to the RS-232 input of the display as shown in Figure 3-2.

Configure the RS-232 controller or PC serial port as follows: no parity, 8 data bits, 1 stop bit and no flow control. Set the baud rate to 115200, to match that of the display RS-232 port.

Command and Response Format

Commands sent from an automation/control system or PC to the display must have the following format:

[STX] [IDT] [TYPE] [CMD] ([VALUE] or [REPLY]) [ETX] [CR]

Where:

- [STX] indicates the start of the command data (always 07).
- [IDT] is the display ID (always 01).
- [TYPE] is the command type:
 - 00 = return to host (response from the LCD panel)
 - 01 = read / action
 - 02 = write
- [VALUE] is the parameter setting for the command.
- [REPLY] is the parameter setting for the command, acknowledged by the display in its response to a command.
- [ETX] indicates the end of the command data (always 08).
- [CR] is the ASCII carriage return key (0x0D).

Command and Response Examples

Here are some examples of serial commands and their responses:

Table 6-1. Serial Command/Response Examples

Description	Command sent to LCD Panel	Response Received from LCD Panel
Turn LCD panel power off.	07 01 02 50 4F 57 00 08	07 01 00 50 4F 57 00 08
Turn LCD panel power on.	07 01 02 50 4F 57 01 08	07 01 00 50 4F 57 01 08
Request LCD panel power status.	07 01 01 50 4F 57 08	07 01 00 50 4F 57 XX 08 (XX = 0 when off or 1 when on)
Set the LCD panel contrast to 30 (1E hex).	07 01 02 43 4F 4E 1E 08	07 01 00 43 4F 4E 1E 08
Reset the LCD panel display settings.	07 01 02 41 4C 4C 00 08	07 01 00 41 4C 4C 00 08
Request LCD panel serial number.	07 01 01 53 45 52 08	07 01 00 53 45 52 S(0)...S(12) 08 S(0) ...S(12) = the serial number in ASCII
Request LCD panel firmware version.	07 01 01 47 56 45 08	07 01 00 47 56 45 S(0)...S(5) 08 S(0) ...S(5) = the firmware version in ASCII

Serial Command List

Table 6-2 lists all supported commands.

Table 6-2. Serial Commands

Main Item	Control Item	CMD	Type	Value (DEC)	Reply (DEC)	Content	CMD (HEX)
Power Control and Input Source	Power	POW	W/R	0	0	Off (soft power)	50 4F 57
				1	1	On (soft power)	
	Input	MIN	W/R	0	0	VGA	4D 49 4E
				9	9	HDMI 1	
				13	0D	Displayport	
				17	11	HDMI 5 (Front Panel)	
			18	12	Media Player (Win/Android)		
Display Adjustment	Display Adjustment	BRI	W/R	0-100	00-64	Back Light Brightness	42 52 49
		BRL	W/R	0-100	00-64	Digital Brightness Level	42 52 4C
		BLC	W/R	0	0	Off (Back Light)	42 4C 43
				1	1	On (Back Light)	
		CON	W/R	0-100	00-64	Contrast	43 4F 4E
		HUE	W/R	0-100	00-64	Hue	48 55 45
		SAT	W/R	0-100	00-64	Saturation	53 41 54
		USR	W/R	0-255	00-FF	Red Gain (mapping 128-383)	55 53 52
USG	W/R	0-255	00-FF	Green Gain (mapping 128-383)	55 53 47		

Main Item	Control Item	CMD	Type	Value (DEC)	Reply (DEC)	Content	CMD (HEX)	
Display Adjustment	Display Adjustment	USB	W/R	0-255	00-FF	Blue Gain (mapping 128-383)	55 53 42	
		UOR	W/R	0-100	00-64	Red Offset (mapping -50-50)	55 4F 52	
		UOG	W/R	0-100	00-64	Green Offset (mapping -50-50)	55 4F 47	
		UOB	W/R	0-100	00-64	Blue Offset (mapping -50-50)	55 4F 42	
	Display Adjustment	COT	W/R	0	0	User	43 4F 54	
				1	1	6500K		
				2	2	9300K		
				6	6	5000K		
				7	7	7500K		
	Display Adjustment	GAC	W/R	0	0	Gamma Off	47 41 43	
				1	1	Gamma 2.2		
		VGA	PHA	W/R	0-63	00-3F	Phase	50 48 41
		Adjustment	CLO	W/R	0-100	00-64	Clock	43 4C 4F
		ADJ	W	0	0	Auto Adjust	41 44 4A	
	Sharpness	SHA	W/R	0-8	0-8	Sharpness	53 48 41	
Other Control	Scaling	ASP	W/R	1	1	Full Screen		
				2	2	Pillarbox/4:3		
				4	4	Auto		
	Baudrate Adjustment	BRA	W/R	0	0	115200	42 52 41	
				1	1	38400		
				2	2	19200		
				3	3	9600		
	Other Control	RCU	W	0	0	MENU Key	52 43 55	
				2	2	UP Key		
				3	3	DOWN Key		
				4	4	LEFT Key		
				5	5	RIGHT Key		
				6	6	ENTER Key		
				7	7	EXIT Key		
				18	12	SOURCE Key		
				23	17	SCALING Key		
				24	18	FREEZE Key		
				25	19	MUTE Key		
				28	1C	AUTO Key		
				29	1D	VOLUME+ Key		
30	1E	VOLUME- Key						

Main Item	Control Item	CMD	Type	Value (DEC)	Reply (DEC)	Content	CMD (HEX)
Other Control	Other Control	RCU	W	43	2B	Blank screen	52 43 55
				44	2C	MediaPlayer / Wln10	
				160	A0	Avocor LowBlue Bright- Key	
				161	A1	Avocor LowBlue Bright+ Key	
		ALL	W	0	0	Reset all	41 4C 4C
		KLC	W/R	0	0	Un-lock keys	4B 4C 43
				1	1	Lock keys	
		SER	R			Read Serial Number	53 45 52
		MNA	R			Read Model Name	4D 4E 41
		GVE	R			Read Firmware Version	47 56 45
	RTV	R			Read RS232 table Version	52 54 56	
	GVS	W	0	0	Querying main scaler version	47 56 53	
			1	1	Querying sub mcu version		
			2	2	Querying network module version		
	Audio	VOL	W/R	0~100	00~64	volume	56 4F 4C
		BAS	W/R	0~12	00~0C	Bass (-6~6)	42 41 53
		TRE	W/R	0~12	00~0C	Treble (-6~6)	54 52 45
		BAL	W/R	0~12	00~0C	Bass (-6~6)	42 41 4C
		HAS	W/R	0	0	HDMI audio source: HDMI	48 41 53
				1	1	HDMI audio source: PC	
DAS		W/R	0	0	DP audio source: DP	44 41 53	
			1	1	DP audio source: PC		
INS		W/R	0	0	Internal Speaker Off	49 4E 53	
			1	1	Internal Speaker On		
MUT	W/R	0	0	Mute Off	4D 55 54		
		1	1	Mute On			

Main Item	Control Item	CMD	Type	Value (DEC)	Reply (DEC)	Content	CMD (HEX)
Other Control	Scheme selection	SCM	W/R	0	0	User	53 43 4D
				1	1	Sport	
				2	2	Game	
				3	3	Cinema	
				4	4	Vivid	
	EcoMode	WFS	W/R	0	0	Set VGA_ONLY	57 46 53
				1	1	Set VGA_DIGITAL_RS232	
				2	2	Set Never_Sleep	
	RTC	RTY	W/R	0~99	00~63	Set Real Time Year	52 54 59
		RTM	W/R	1~12	01~0C	Set Real Time Month	52 54 4D
		RTD	W/R	1~31	01~1F	Set Real Time Day	52 54 44
		RTH	W/R	0~23	00~17	Set Real Time Hour	52 54 48
		RTN	W/R	0~59	00~3B	Set Real Time Minute	52 54 4E
		TMS	W/R	0	0	Same Settings On All	54 4D 53
				1	1	Same Settings On Work Days	
				2	2	User	
		AEN	W/R	1	1	Sunday Alarm Enable	41 45 4E
				2	2	Monday Alarm Enable	
				4	4	Tuesday Alarm Enable	
				8	8	Wednesday Alarm Enable	
				16	10	Thursday Alarm Enable	
				32	20	Friday Alarm Enable	
				64	40	Saturday Alarm Enable	
		AEF	W/R	1	1	Sunday Alarm Disable	41 45 46
				2	2	Monday Alarm Disable	
				4	4	Tuesday Alarm Disable	
				8	8	Wednesday Alarm Disable	
				16	10	Thursday Alarm Disable	
				32	20	Friday Alarm Disable	
				64	40	Saturday Alarm Disable	
		NNH	W/R	0~23	00~17	Monday On Hour	4E 4E 48
	NNM	W/R	0~59	00~3B	Monday On Minute	4E 4E 4D	
NFH	W/R	0~23	00~17	Monday Off Hour	4E 46 48		
NFM	W/R	0~59	00~3B	Monday Off Minute	4E 46 4D		
ENH	W/R	0~23	00~17	Tuesday On Hour	45 4E 48		
ENM	W/R	0~59	00~3B	Tuesday On Minute	45 4E 4D		
EFH	W/R	0~23	00~17	Tuesday Off Hour	45 46 48		

Main Item	Control Item	CMD	Type	Value (DEC)	Reply (DEC)	Content	CMD (HEX)
Other Control	Scheme selection	EFM	W/R	0~59	00~3B	Tuesday Off Minute	45 46 4D
		DNH	W/R	0~23	00~17	Wednesday On Hour	44 4E 48
		DNM	W/R	0~59	00~3B	Wednesday On Minute	44 4E 4D
		DFH	W/R	0~23	00~17	Wednesday Off Hour	44 46 48
		DFM	W/R	0~59	00~3B	Wednesday Off Minute	44 46 4D
		UNH	W/R	0~23	00~17	Thursday On Hour	55 4E 48
		UNM	W/R	0~59	00~3B	Thursday On Minute	55 4E 4D
		UFH	W/R	0~23	00~17	Thursday Off Hour	55 46 48
		UFM	W/R	0~59	00~3B	Thursday Off Minute	55 46 4D
		INH	W/R	0~23	00~17	Friday On Hour	49 4E 48
		INM	W/R	0~59	00~3B	Friday On Minute	49 4E 4D
		IFH	W/R	0~23	00~17	Friday Off Hour	49 46 48
		IFM	W/R	0~59	00~3B	Friday Off Minute	49 46 4D
		TNH	W/R	0~23	00~17	Saturday On Hour	54 4E 48
	TNM	W/R	0~59	00~3B	Saturday On Minute	54 4E 4D	
	RTC	TFH	W/R	0~23	00~17	Saturday Off Hour	54 46 48
		TFM	W/R	0~59	00~3B	Saturday Off Minute	54 46 4D
		SNH	W/R	0~23	00~17	Sunday On Hour	53 4E 48
		SNM	W/R	0~59	00~3B	Sunday On Minute	53 4E 4D
		SFH	W/R	0~23	00~17	Sunday Off Hour	53 46 48
		SFM	W/R	0~59	00~3B	Sunday Off Minute	53 46 4D
	Auto Scan	ATS	W/R	0	0	Off	41 54 53
				1	1	On	
	IRFM	IRF	W/R	0	0	Off	49 52 46
				1	1	On	
	Smart Light Control	SLC	W/R	0	0	Off	53 4C 43
				1	1	DCR	
				2	2	Light Sensor	
	Power LED	LED	W/R	0	0	Off	4C 45 44
				1	1	On	
HDMI RGB Color Range	HCR	W/R	0	0	Auto Detect	48 43 52	
			1	1	Full Range		
			2	2	Limited Range		
Touch Control	TOC	W/R	0	0	Auto (Read Only)	54 4F 43	
			2	2	External (Touch1 / Front USB)		
			3	3	External Touch 2		
			4	4	Win10		

Main Item	Control Item	CMD	Type	Value (DEC)	Reply (DEC)	Content	CMD (HEX)
WIN10 Player	Win10 Power Control	WPC	W/R	0	0	Write: 0 - Release Win PC power button	57 50 43
						Write: 1 - Press Win PC power button	
				1	1	Write: 0 - Release Win PC power button	
						Write: 1 - Press Win PC power button	
				2	2	Write: 2 - Press Win PC power button for 1 second	
				3	3	Write: 3 - Press Win PC power button for 4 seconds	
4	4	Write: 4 - If Win PC is On then force shutdown Win PC (Press Win PC power button till Win PC is off)					
OSD Control	Transparency	OST	W/R	0~4	00~04	OSD Transparency	4F 53 54
	H Position	OSH	W/R	0~100	00~64	OSD H Position	4F 53 48
	V Position	OSV	W/R	0~100	00~64	OSD V Position	4F 53 56
	OSD Timeout	OSO	W/R	5~60	05~3C	OSD Timeout (5, 10, 20, 30, 60 sec)	4F 53 4F
	Splash Screen	SPS	W/R	0	0	Off	53 50 53
1				1	On		
Ethernet Setup	Network Enable	NWE	W/R	0	0	No	4E 57 45
				1	1	Yes	
	Dynamic IP	DIP	W/R	0	0	Disable	44 49 50
				1	1	Enable	
	Default	LDS	W	0	0	Load network default settings (It will take about 15 seconds.)	4C 44 53
	E-Mail Alert	PSA	W/R	0	0	Off (Power Status Alert)	50 53 41
				1	1	On (Power Status Alert)	
		SSA	W/R	0	0	Off (Source Status Alert)	53 53 41
				1	1	On (Source Status Alert)	
		SLA	W/R	0	0	Off (Signal Lost Alert)	53 4C 41
				1	1	On (Signal Lost Alert)	
	Static IP Settings	IP1	W/R	0~255	00~FF	Static IP Address 1	49 50 31
		IP2	W/R	0~255	00~FF	Static IP Address 2	49 50 32
		IP3	W/R	0~255	00~FF	Static IP Address 3	49 50 33
IP4		W/R	0~255	00~FF	Static IP Address 4	49 50 34	
MK1		W/R	0~255	00~FF	Subnet Mask 1	4D 4B 31	
MK2		W/R	0~255	00~FF	Subnet Mask 2	4D 4B 32	

Main Item	Control Item	CMD	Type	Value (DEC)	Reply (DEC)	Content	CMD (HEX)
Ethernet Setup	Static IP Settings	MK3	W/R	0-255	00-FF	Subnet Mask 3	4D 4B 33
		MK4	W/R	0-255	00-FF	Subnet Mask 4	4D 4B 34
		GW1	W/R	0-255	00-FF	Gateway 1	47 57 31
		GW2	W/R	0-255	00-FF	Gateway 2	47 57 32
		GW3	W/R	0-255	00-FF	Gateway 3	47 57 33
		GW4	W/R	0-255	00-FF	Gateway 4	47 57 34
		FD1	W/R	0-255	00-FF	DNS Address 1	46 44 31
		FD2	W/R	0-255	00-FF	DNS Address 2	46 44 32
		FD3	W/R	0-255	00-FF	DNS Address 3	46 44 33
		FD4	W/R	0-255	00-FF	DNS Address 4	46 44 34
		SNS	W	0	0	Save Network Settings	53 4E 53
		MAC	W	0-5	00-05	Querying MAC ID #0-#5	4D 41 43

Using Discrete IR Codes

The display accepts commands in the form of infrared (IR) signals that conform to the NEC protocol. Each display remote control button has an IR control code associated with it.

You can use these codes to program a third-party, “universal” remote control unit to work with the display. These third-party products usually come with a computer software application for this purpose. For more information, consult the documentation provided with the remote control unit.

IR Command Protocol

The IR control codes have the following characteristics:

- Each code consists of the following:
 - A leader pulse (a modulated pulse of 9 ms followed by a non-modulated pulse of 4.5 ms);
 - 16 address bits (also called a “custom code”): eight (8) bits for the address followed by the logical inverse of the address. The custom code for the display is 16559 decimal (0x40AF, binary 01000000 10101111).
 - 16 data bits: eight (8) bits for the command followed by the logical inverse of the command; and
 - An end pulse (a modulated pulse of 0.56 ms, similar to the modulated pulse in the ‘0’ and ‘1’ bits). The end of the modulated pulse constitutes the end of the data transmission.
- The carrier frequency is 38 kHz, with the modulated pulses having a 33% duty cycle.
- Commands are sent at a maximum rate of 9 Hz.

For example, here is the NEC control code for the POWER button on the display remote control unit:

Hex	40	AF	1C	E3
Binary	01000000	10101111	00011100	11100011
Function	Cust. Code Byte 1	Cust. Code Byte 2	Command	Command (Logical Inverse)

IR Control Code List

Table 6-3 lists the IR control codes for the display.

Table 6-3. Infrared (IR) Control Codes

NO	Customer Code	Data Code	Function
1	40AF	04FB	-----
2	40AF	1CE3	POWER
3	40AF	07F8	SOURCE
4	40AF	08F7	-----
5	40AF	09F6	WIN PC
6	40AF	0AF5	BLANK
7	40AF	0BF4	-----
8	40AF	0CF3	FREEZE
9	40AF	1AE5	-----
10	40AF	15EA	MUTE
11	40AF	10EF	-----
12	40AF	11EE	VOLUME -
13	40AF	0DF2	-----
14	40AF	16E9	VOLUME +
15	40AF	06F9	BRIGHTNESS SETTINGS -
16	40AF	13EC	BRIGHTNESS SETTINGS +
17	40AF	02FD	UP
18	40AF	01FE	LEFT
19	40AF	0EF1	MENU
20	40AF	03FC	RIGHT
21	40AF	19E6	DOWN
22	40AF	12ED	ENTER
23	40AF	05FA	EXIT
24	40AF	40BF	-----
25	40AF	41BE	-----
26	40AF	14EB	AUTO
27	40AF	43BC	-----
28	40AF	00FF	SCALING
29	40AF	17E8	-----
30	40AF	18E7	-----
31	40AF	1EE1	-----
32	40AF	0FF0	-----
33	40AF	1BE4	-----
34	40AF	1DE2	-----
35	40AF	1FE0	-----
36	40AF	42BD	-----

Notes

7. Specifications

AVF-6500	
PANEL	
Diagonal Size (Inch)	65"
Backlight	Direct LED
Aspect Ratio	16:9
Input Resolution	1920 x 1080 @ 60 Hz
Response Time	8 (typ)
Brightness	350 (cd/m ²)
Contrast Ratio	4000:1
Viewing Angle	178° (H) / 178° (V)
Supported Colours	1.07B colours
Display Orientation	Landscape compatible
TOUCH SYSTEM	
Interface	Touch USB
Touch	High-resolution InGlass™ touch; Up to 10 points
Glass	AG glass; 0.12 inch thickness
Supported Operating System	Windows 7 / 8 / 10
AUDIO	
Built-in Speakers	4 KΩ / 2 x 10W
CONNECTIVITY	
Connections	2 x HDMI / 1 x DisplayPort / 1 x VGA
Audio	Audio Out / PC Audio In
Control	2 x Touch USB / RS232 / Ethernet
WIN PC <small>Note</small>	
CPU	Intel Atom Quad Core Processor
Memory	2GB DDR3
Storage	32GB (eMMC)
Ethernet	10/100 Mbps (RJ-45)
WiFi	802.11 b/g/n, 2.4GHz, 1T1R, Realtek RTL8723BS Module
Bluetooth	4.0
USB 2.0/3.0	x2 /x1 (Type A)
OS	Windows 10 Home Edition (x64)

PHYSICAL SPECIFICATIONS	
Dimensions	58.99 x 36.21 x 4.04 (in)
Weight	Net: 57 kg / Gross: 67 kg
Wall Mount	15.75 x 15.75 (in) VESA; 3.94 x 3.94 (in) for IPC Mounting
Fanless Design	Yes
OSD FUNCTIONS	
OSD Languages	English, French, German, Dutch, Hungarian, Slovene, Serbian, Croatian, Danish
Source Auto Detect Function	Yes
OSD Key Lock Function	Yes
POWER	
Power Supply	AC100-240V (Worldwide), Max 3A, 50/60Hz
Maximum Power Consumption	250 W
Standby	≤0.5 W
ENVIRONMENTAL	
Operating Temperature	5 °C ~ 35 °C
Storage Temperature	-20 °C ~ 60 °C
Humidity	35% ~ 85%



NOTE

When the display is powered up for the first time, turning on the WIN PC will take 12-20 seconds to initiate.

Supported Timings

Table 7-2 lists the signal types supported by each input on the display.

Table 7-2. Supported Timings By Input

Timing		fH (kHz)	fV (Hz)	Dot clock (MHz)	HDMI	PC	DisplayPort	
VESA	VGA 640x480	31.469	59.94	25.175	○	○	○	
	SVGA 800x600	35.156	56.25	36	○	○	○	
		37.879	60.317	40	○	○	○	
	XGA 1024x768	48.363	60.004	65	○	○	○	
	WXGA 1366x768	47.712	59.79	85.5	○	○	○	
	1280 x 720	44.444	59.98	64	○	○	○	
		44.772	59.86	74.5	○	○	○	
	1280 x 768	47.776	59.87	79.5	○	○	○	
		47.396	59.995	68.25	○	○	○	
	1280 x 800	49.306	59.91	71	○	○	○	
		49.702	59.81	83	○	○	○	
	SXGA	1280x1024	63.981	60.02	108	○	○	○
	SXGA+	1400 x1050	64.744	59.95	101	○	○	○
			65.317	59.98	121.75	○	○	○
	1440 x 900		55.469	59.901	88.75	○	○	○
			55.935	59.88	106.5	○	○	○
WSXGA+ 1680 x1050		64.674	59.883	119	○	-	○	
		65.29	59.954	146.25	○	-	○	
UXGA 1600 x 1200		75	60	162	○	○	○	
1920 x 1080		66.587	59.93	138.5	○	○	○	
EDTV	480p	31.5	60	27.03	○	-	○	
	576p	31.25	50	27	○	-	○	
HDTV	720p 1280x720	37.5	50	74.25	○	-	○	
		44.995	59.94	74.176	○	-	○	
		45	60	74.25	○	-	○	
	1080p 1920x1080	67.433	59.94	148.352	○	-	○	
		67.5	60	148.5	○	-	○	

Overall Dimensions

Figure 7-1 shows the display dimensions of AVF-6500 (all dimensions are in inches).

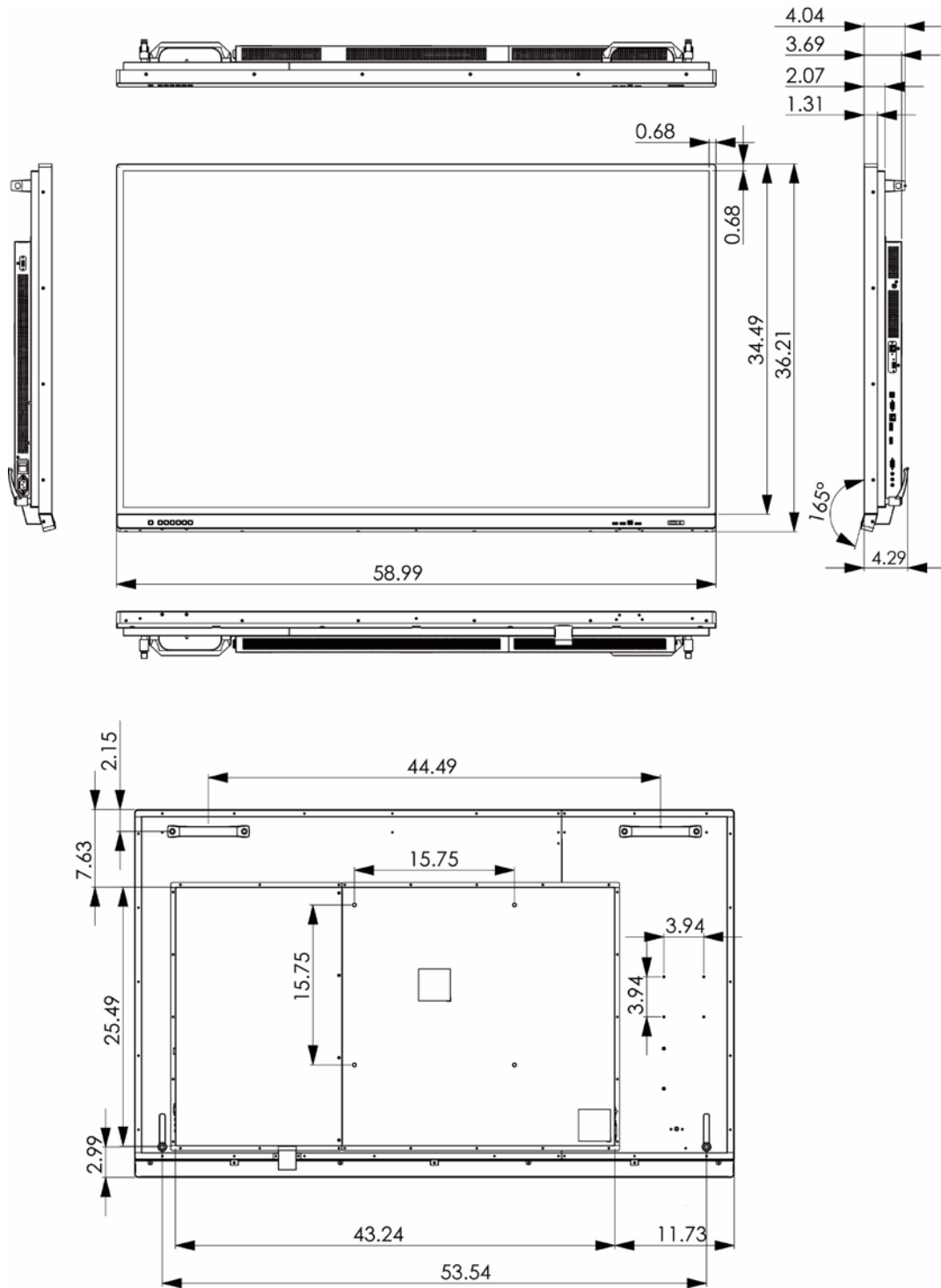

Figure 7-1. AVF-6500 Display Dimensions

Notes

Appendix I: Moving and Carrying Notice

Moving the Display:

Moving the display requires at least two people. Attempting to move the display with one person may result in dropping the display and/or serious injury. When moving a display in its shipping carton, lift the carton using the white handles.

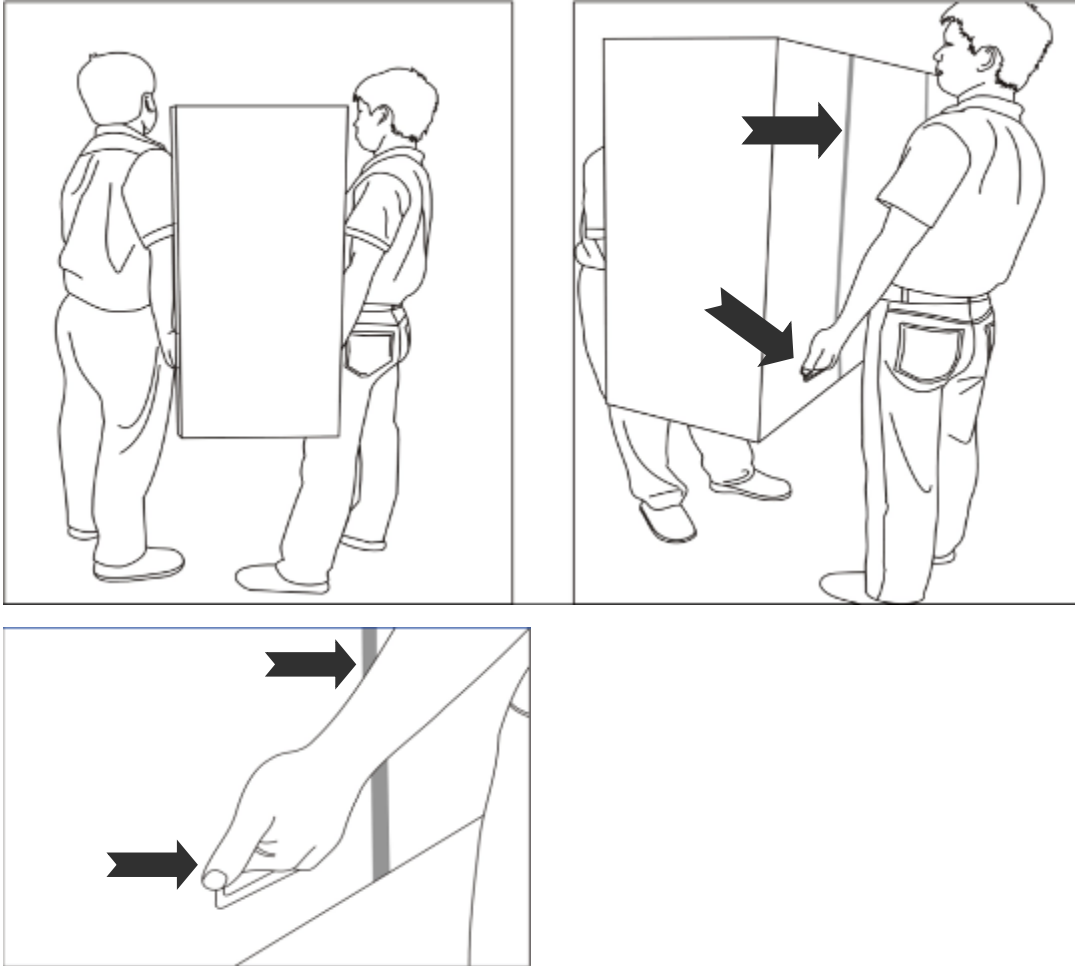

Carrying the display:

This display is heavy; please follow proper lifting technique, as pictured below. Failure to do so may cause injury.



Appendix II: Installing a Wall Mount

Follow the manual instructions for the type of mount you have selected. Refer all servicing to qualified service personnel.

Moving the display requires at least two people. Make sure you use the upper handles (A) and lower lever arms (B) in the back of the display while lifting or moving the display, to avoid touching the front panel during the move.

Before installing, please make sure the wall is strong enough to hold the necessary weight of the display and the mount.

Step1. Keep the display facing the ground and place it on a flat object.

Step2. Remove the 4 screws (M8*15) from the back of the display.

Step3. Align the wall brackets with the mounting holes and attach the brackets to the display using the screws removed in Step 2.

Caution: Longer screws will damage the display.

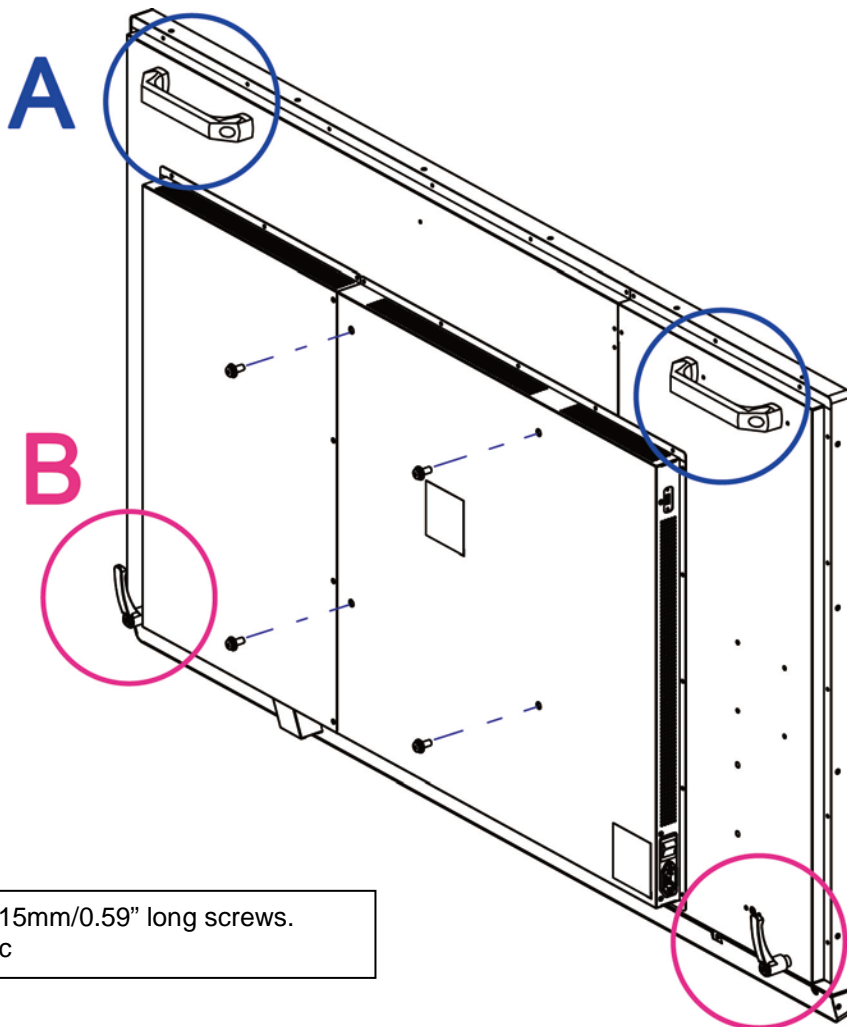

Appendix III: Wall Mount Safety Notes

1. Please make sure if the bracket is fixed to the solid wall / solid pillar for fear of falling due to heavy weight.

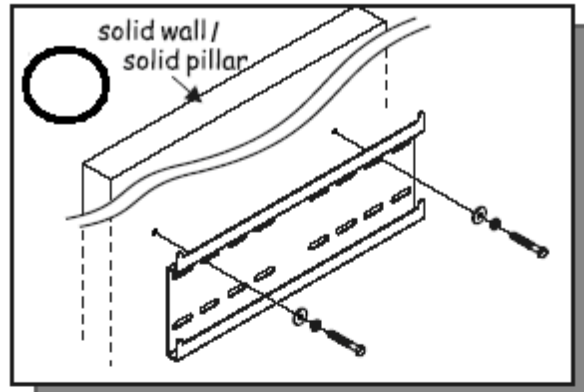
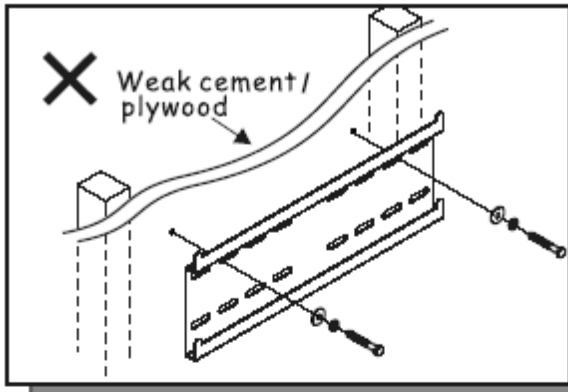

2. After assembling, please don't pull or shake violently.

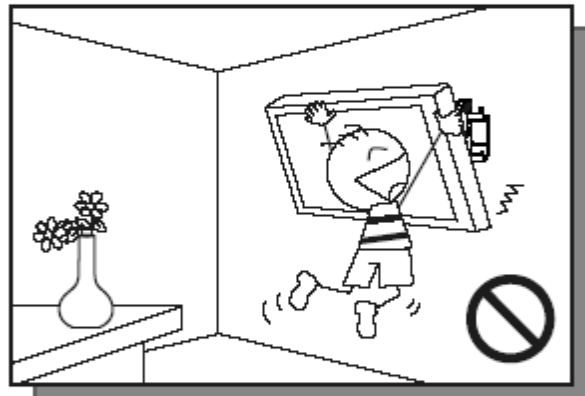
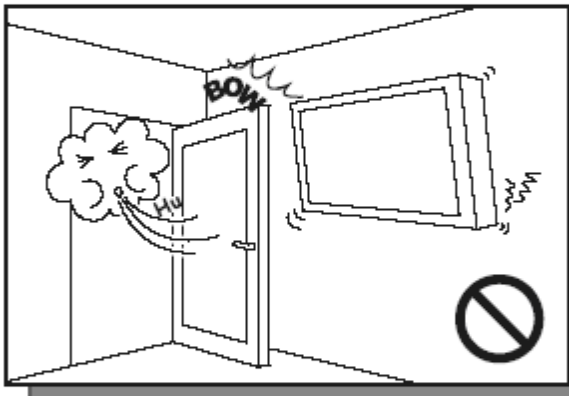

3. Please don't install the bracket directly under the sunshine or humidity / high temperature places for fear that the quality is effected.

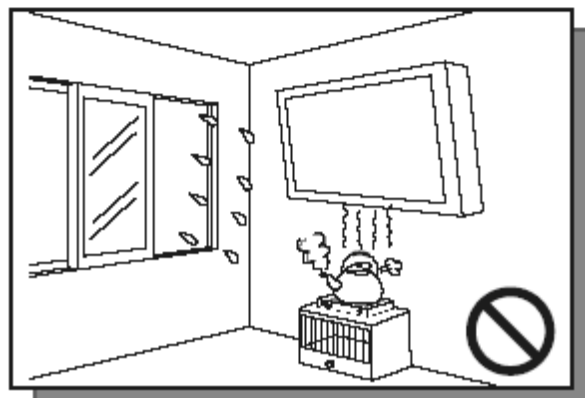
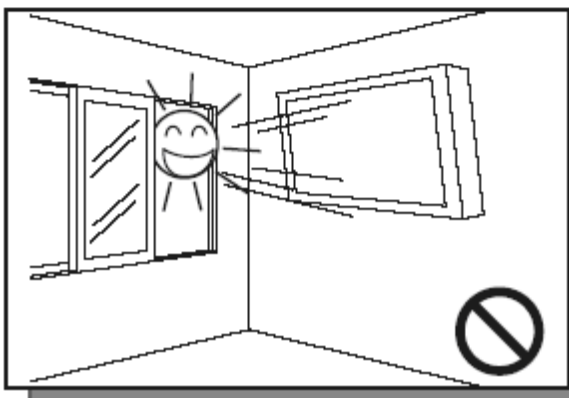

4.

Installing the bracket over 10 cm from each wall side and being vertical to the ground is the suggested installing position.

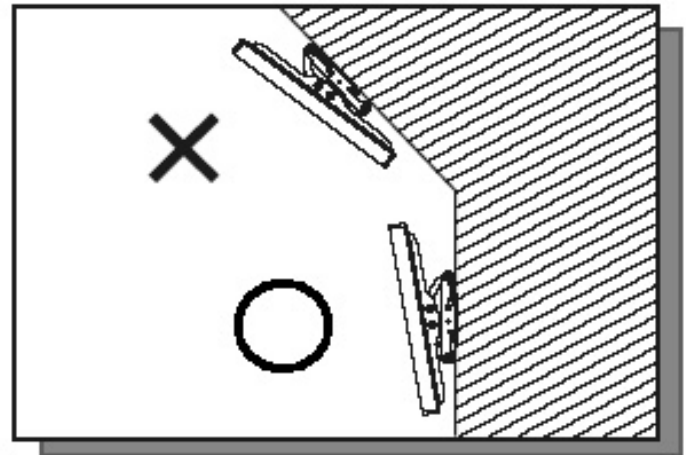
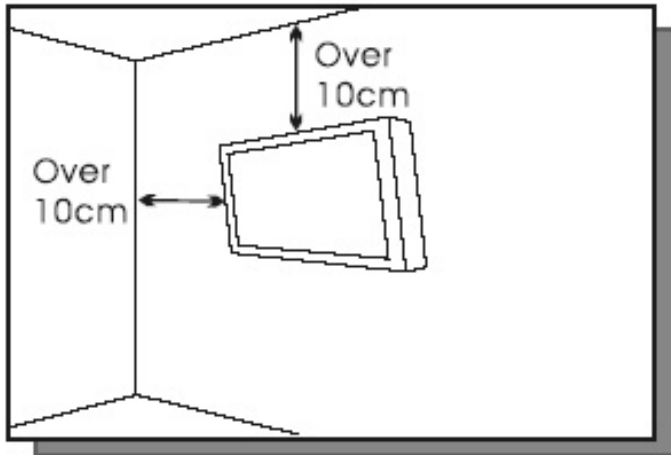

5.

Please make sure to hang on the mounting hooks firmly.

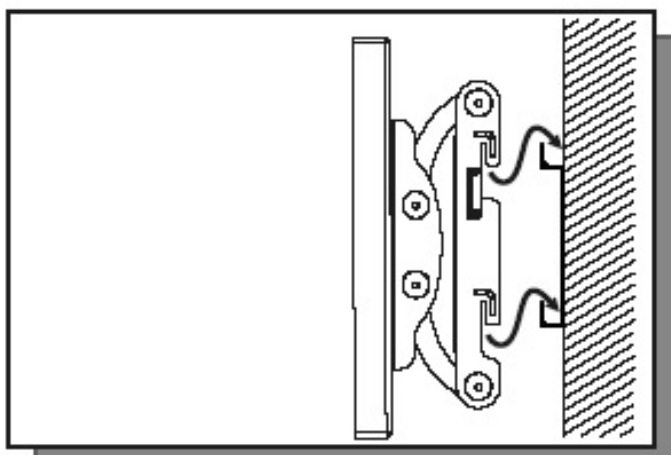

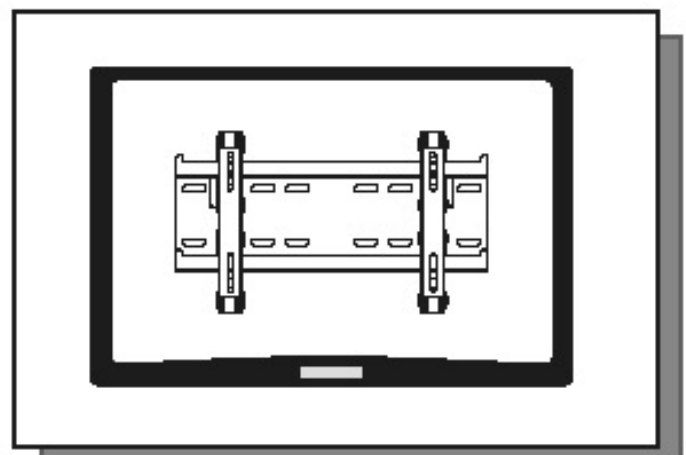

6.

The flat screen must be put in the mid of the bracket for fear of slope.



Appendix IV: Power/PC Key Operations

	When current input is WIN PC:	When current input is NOT WIN PC:
	<ul style="list-style-type: none"> When Win10 PC Power Mode is set to Auto or Manual, pressing the button once will turn on Win10 PC. When Win10 PC is on, pressing the button once will turn off Win10 PC. 	<ul style="list-style-type: none"> When Win10 PC Power Mode is set to Auto or Manual, pressing the button once will switch the input source to Win10 PC and turn on Win10 PC.
	<ul style="list-style-type: none"> Press the button to turn on/off the display. When Win10 PC Power Mode is set to Auto, pressing the button will turn on the display and Win10 PC. When Win10 PC is running and Win10 PC Power Mode is set to Auto or Manual, pressing the button will turn off the screen and Win10 PC will remain running in the background. 	



NOTE

1. Operation of the power/PC keys will not conform to the description above if you have made changes to the default Power/Sleep settings in the windows PC.
2. Please avoid unplugging the AC power cord while WIN PC is still on. To check the status of WIN PC, you may check the floating message box on screen, or use the remote control to enter the OSD menu and find the information in the Information menu page.

Appendix V: Ethernet Remote Control Settings

The device can be configured by opening a browser and connecting to web server directly.

Use the browser to configure the demo board. Connect the browser to the IP address of NET2UART module, and the Login window will pop up as follows.

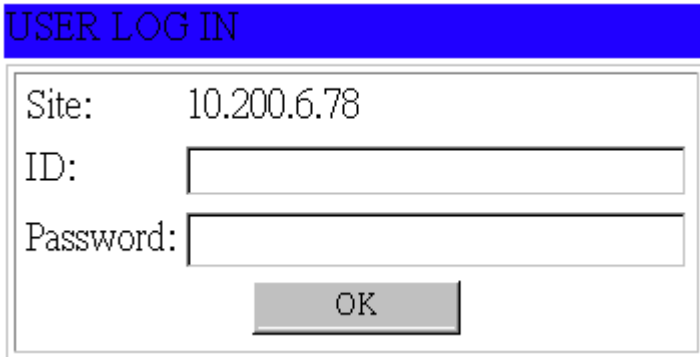

Default IP 192.168.2.1
Default ID admin
Default Password system

Configurations

Administrator

Authentication Configuration

Administrator

- [Authentication Configuration](#)
- [System IP Configuration](#)
- [Network Status](#)
- [Display Status](#)
- [Load default setting](#)
- [Firmware update](#)
- [Boot Loader upgrade](#)

TCP Mode

UDP Mode

UART

SMTP

Reset Device

Logout

Authentication Configuration

Setting	Value
Username	<input type="text" value="admin"/> max:15
Password	<input type="password" value="•••••"/> max:15
Confirm	<input type="password" value="•••••"/>

Please refresh web page after press "updated" button.

Note:
Comment name only can use "0-9", "a-z", "A-Z"

System IP Configuration

Administrator

[Authentication Configuration](#)

[System IP Configuration](#)

[Network Status](#)

[Display Status](#)

[Load default setting](#)

[Firmware update](#)

[Boot Loader upgrade](#)

[TCP Mode](#)

[UDP Mode](#)

[UART](#)

[SMTP](#)

[Reset Device](#)

[Logout](#)

System IP Configuration

Setting	Value
IP Address	<input type="text" value="192"/> . <input type="text" value="168"/> . <input type="text" value="2"/> . <input type="text" value="1"/>
Subnet Mask	<input type="text" value="255"/> . <input type="text" value="255"/> . <input type="text" value="255"/> . <input type="text" value="0"/>
Gateway	<input type="text" value="192"/> . <input type="text" value="168"/> . <input type="text" value="2"/> . <input type="text" value="1"/>
DNS	<input type="text" value="192"/> . <input type="text" value="168"/> . <input type="text" value="2"/> . <input type="text" value="1"/>
IP Configure	<input type="radio"/> Static <input checked="" type="radio"/> DHCP
VLAN Tag	<input checked="" type="radio"/> Disable <input type="radio"/> Enable : VLAN ID <input type="text" value="0"/>

Please refresh web page after press "updated" button.

Network Status

Administrator

[Authentication Configuration](#)

[System IP Configuration](#)

[Network Status](#)

[Display Status](#)

[Load default setting](#)

[Firmware update](#)

[Boot Loader upgrade](#)

[TCP Mode](#)

[UDP Mode](#)

[UART](#)

[SMTP](#)

[Reset Device](#)

[Logout](#)

Network Status

Kernel Version	V3021 (Feb 17 2014 14:42:18)
MAC Address	00:1F:B6:00:01:DB
Nickname	<input type="text" value="NetUART"/> <input type="button" value="Update"/> Please refresh web page after press "updated" button.

Note:

Comment name only can use "0-9","a-z","A-Z","_","-"

Load Default Setting

Administrator

[Authentication Configuration](#)

[System IP Configuration](#)

[Network Status](#)

[Display Status](#)

[Load default setting](#)

[Firmware update](#)

[Boot Loader upgrade](#)

[TCP Mode](#)

[UDP Mode](#)

[UART](#)

[SMTP](#)

[Reset Device](#)

[Logout](#)

Load Default Setting to EEPROM

Firmware Update

Administrator

[Authentication](#)

[Configuration](#)

[System IP](#)

[Configuration](#)

[Network Status](#)

[Display Status](#)

[Load default setting](#)

[Firmware update](#)

[Boot Loader upgrade](#)

[TCP Mode](#)

[UDP Mode](#)

[UART](#)

[SMTP](#)

[Reset Device](#)

[Logout](#)

Firmware update

Load

Boot Loader Upgrade

Administrator

[Authentication](#)

[Configuration](#)

[System IP](#)

[Configuration](#)

[Network Status](#)

[Display Status](#)

[Load default setting](#)

[Firmware update](#)

[Boot Loader upgrade](#)

[TCP Mode](#)

[UDP Mode](#)

[UART](#)

[SMTP](#)

[Reset Device](#)

[Logout](#)

Upgrade the Boot Loader

Load

TCP Mode

Administrator

[Authentication Configuration](#)

[System IP Configuration](#)

[Network Status](#)

[Display Status](#)

[Load default setting](#)

[Firmware update](#)

[Boot Loader upgrade](#)

[TCP Mode](#)

[UDP Mode](#)

[UART](#)

[SMTP](#)

[Reset Device](#)

[Logout](#)

TCP Control

Item	Value
Telnet Server/Client	<input checked="" type="radio"/> Server <input type="radio"/> Client <input type="radio"/> Disable
Data Port Number	<input type="text" value="23"/>
Remote Server IP Address	<input checked="" type="radio"/> IP <input type="text" value="210"/> <input type="text" value="200"/> <input type="text" value="181"/> <input type="text" value="102"/> <input type="radio"/> Domain Name <input type="text" value="0"/>
Client mode inactive timeout	<input type="text" value="20"/> minute (1~99,0=Disable)
Server mode protect timeout	<input type="text" value="60"/> minute (1~98,0=Disable,99=Can't replace)
<input type="button" value="Update"/> Please refresh web page after press "updated" button.	

Telnet Server/Client

Set the device to be a Telnet Server or Client.

Port Number

When in Server mode, assign the port number used to connect remotely. When in Client mode, assign the port number for the device to connect to the remote site.

Remote Server IP Address

When in Client mode, the device will connect to the remote server with the IP address set here.

Client mode inactive timeout

When NET2UAR is operating in TCP client mode, it will always try to connect with the remote server. The time configured here is for NET2UART to rebuild connection after timeout.

Server mode protect timeout

When NET2UART is operating in TCP server mode, it would protect the TCP connection from getting replaced in the period of the time set here.

UDP Mode

Administrator

- [Authentication Configuration](#)
- [System IP Configuration](#)
- [Network Status](#)
- [Display Status](#)
- [Load default setting](#)
- [Firmware update](#)
- [Boot Loader upgrade](#)

TCP Mode

UDP Mode

UART

SMTP

Reset Device

Logout

UDP

Item	Value	
Mode	<input type="radio"/> Listen <input type="radio"/> Normal <input checked="" type="radio"/> Disable	
Local Port	21	
Remote Address	IP	Port
	<input checked="" type="radio"/> 0 . 0 . 0 . 0 IP <input type="radio"/> Domain Name	0
	<input checked="" type="radio"/> 0 . 0 . 0 . 0 IP <input type="radio"/> Domain Name	0
	<input checked="" type="radio"/> 0 . 0 . 0 . 0 IP <input type="radio"/> Domain Name	0
	<input checked="" type="radio"/> 0 . 0 . 0 . 0 IP <input type="radio"/> Domain Name	0
	<input checked="" type="radio"/> 0 . 0 . 0 . 0 IP <input type="radio"/> Domain Name	0
	<input checked="" type="radio"/> 0 . 0 . 0 . 0 IP <input type="radio"/> Domain Name	0
	<input checked="" type="radio"/> 0 . 0 . 0 . 0 IP <input type="radio"/> Domain Name	0
	<input checked="" type="radio"/> 0 . 0 . 0 . 0 IP <input type="radio"/> Domain Name	0
	<input checked="" type="radio"/> 0 . 0 . 0 . 0 IP <input type="radio"/> Domain Name	0
<input type="button" value="Update"/>		
Please refresh web page after press "updated" button.		

Status

When TCP mode is set as Server mode or Client mode, the UDP mode would be disabled automatically, and vice versa.

Local Port

Assign the port number here to allow the device to open for the remote site to send data via UDP. The IP address of the remote site must be set in the Remote Address table, or NET2UART will ignore its data.

Remote Address

The Remote Address table allows 10 entries of remote site IP addresses and ports. When NET2UART is sending data to network, the data will be sent to the each remote IP address entered in the table simultaneously. The port number is the remote site port number that NET2UART will send data to via UDP.

If the port number is set as "0", the NET2UART will use the port number that the remote site sends data from as the destination port number, or use the local port number as the destination port number if the remote site has not sent data to NET2UART.

UART

Administrator

- [Authentication Configuration](#)
- [System IP Configuration](#)
- [Network Status](#)
- [Display Status](#)
- [Load default setting](#)
- [Firmware update](#)
- [Boot Loader upgrade](#)

TCP Mode

UDP Mode

UART

SMTP

Reset Device

Logout

UART Control

Item	Setting
Mode	RS232
Baudrate	115200
Character Bits	8
Parity Type	none
Stop Bit	1
Hardware Flow Control	none
Uart Memory Overflow count	0M,0K,0Byte
Uart FIFO Overflow count	0times
Delimiter	<input type="checkbox"/> Character 1: 00, <input type="checkbox"/> Character 2: FF <input type="checkbox"/> Silent time: 5 (1~255)*200ms <input type="checkbox"/> Drop Character
<input type="button" value="Update"/> Please refresh web page after press "updated" button.	

Mode

Select the UART interface.

Baud rate

Select the baud rate of UART interface.

Character Bits

Select the number of character bits of UART interface.

Parity Type

Select the parity type of UART interface.

Stop Bit

Select the stop bit type of UART interface.

Hardware Flow Control

Select the flow control type of UART interface. The hardware flow control will use CTS/RTS for the control signals.

Uart Memory Overflow count

Shows the number of overflow bytes in network buffer.

Uart FIFO Overflow count

Shows the number of overflow times in UART RX buffer.

Delimiter

- Character 1 & 2:

Set Character 1 and/or Character 2 to be the delimiter.

Once the delimiter is active, NET2UART would monitor all data received from UART. All data received from UART will be stored in NET2UART internal buffer first, and will only be sent to Ethernet once the delimiter is detected. If the delimiters have not been detected and the internal buffer of NET2UART is stuffed, the incoming data will overwrite the previous data stored in NET2UART.

- Drop Character:

The Drop Character is set to drop delimiter or not. If Drop Character is active, the delimiter received from UART will not be sent out to Ethernet.

- Silent time:

Once the Silent time is active, NET2UART will keep all data received from UART in its internal buffer and check the time period of no data received from UART. It will then send out the internal data once the time is out.

SMTP

Administrator

[Authentication](#)

[Configuration](#)

[System IP](#)

[Configuration](#)

[Network Status](#)

[Display Status](#)

[Load default setting](#)

[Firmware update](#)

[Boot Loader upgrade](#)

[TCP Mode](#)

[UDP Mode](#)

[UART](#)

[SMTP](#)

[Reset Device](#)

[Logout](#)

SMTP setup

Enable SMTP	<input type="checkbox"/> Enable,Port: 25
SMTP server address	smtp.xxx.yyy
SMTP Login Information	<input type="checkbox"/> Enable Username: username, Password: ●●●●●●
Mail to	xxx@yyy.zzz max: 200
Mail from	xxx@yyy.zzz
SMTP 01 Warning	
Subject	Power Status Change Alert
Message Body	SMTP 01 body max: 100
SMTP 02 Warning	
Subject	Source Change Alert
Message Body	SMTP 02 body max: 100
SMTP 03 Warning	
Subject	Signal Lost Alert
Message Body	SMTP 03 body max: 100

Reset Device

Reset NET2UART module.

[Administrator](#)

[TCP Mode](#)

[UDP Mode](#)

[UART](#)

[SMTP](#)

[Reset Device](#)

[Logout](#)

Reset Device

Reset