

Installation manual

Part nr. 902831-02

Mobile stand

For the BalanceBox®400 and 400H

Safety Instructions

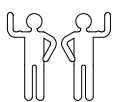

Tools needed



The contents of the box

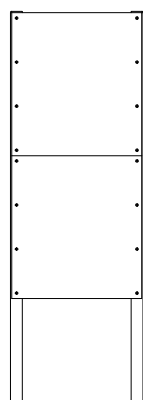

A
(1x)

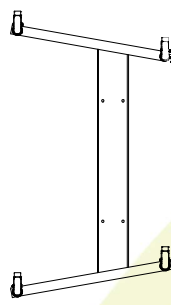

B
(1x)



C
(1x)



D
(4x)



E
(2x)

F
(2x)

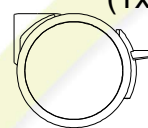

G
(2x)

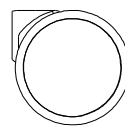

H
(2x)

1

Assemble (● 10 mm)

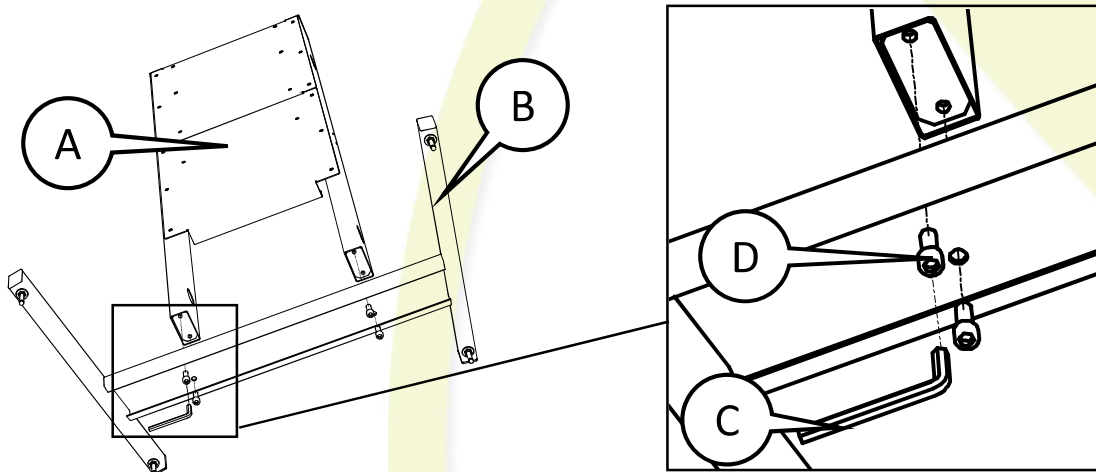

2

Use the allen key and a rubber mallet to tap the wheels to lock them on the wheelpin

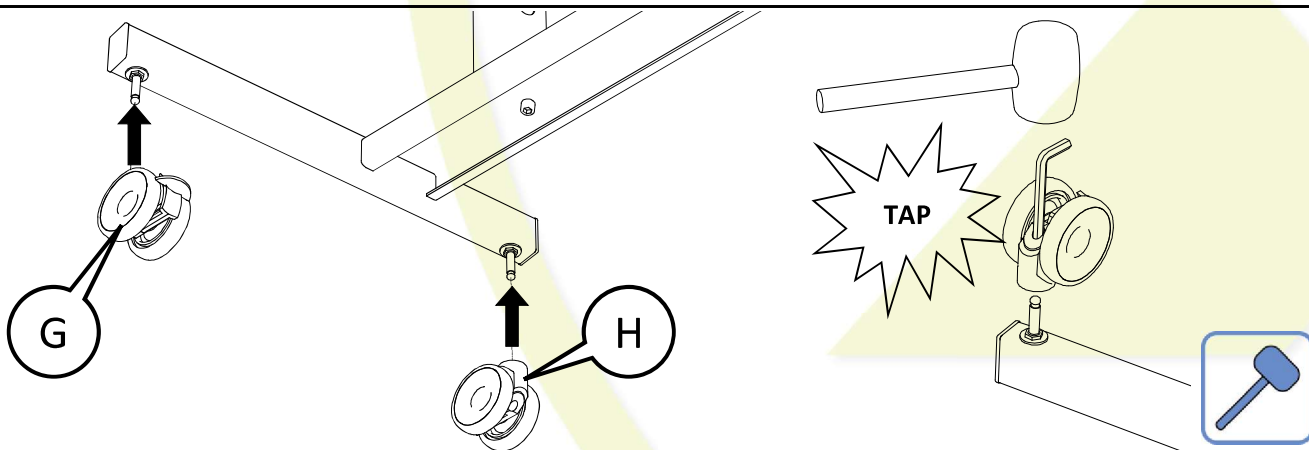

3 Mount the BalanceBox® bracket (2 options for mounting height)

Included with BalanceBox®

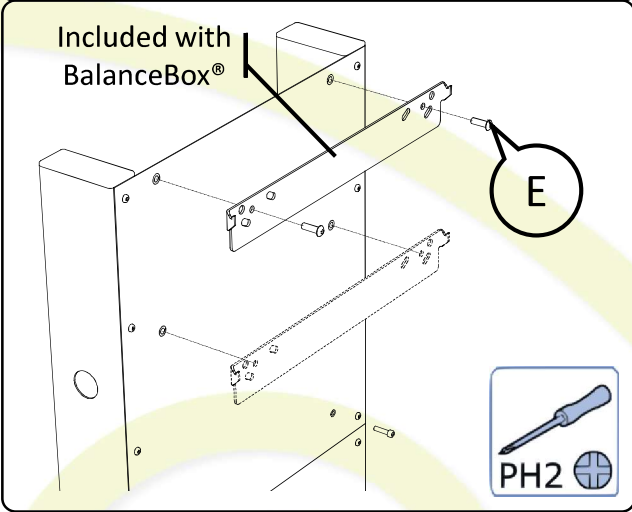

E

PH2

4 Please refer to:
BalanceBox® Installation Manual

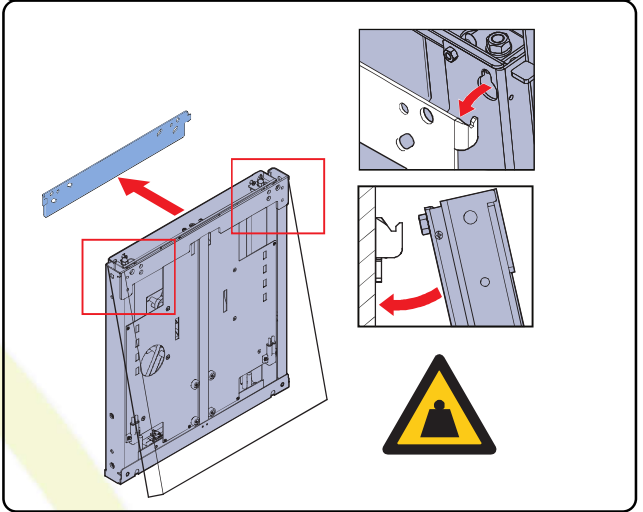

Warning: Heavy load

5 Lock BalanceBox®400 with safety screws at the bottom

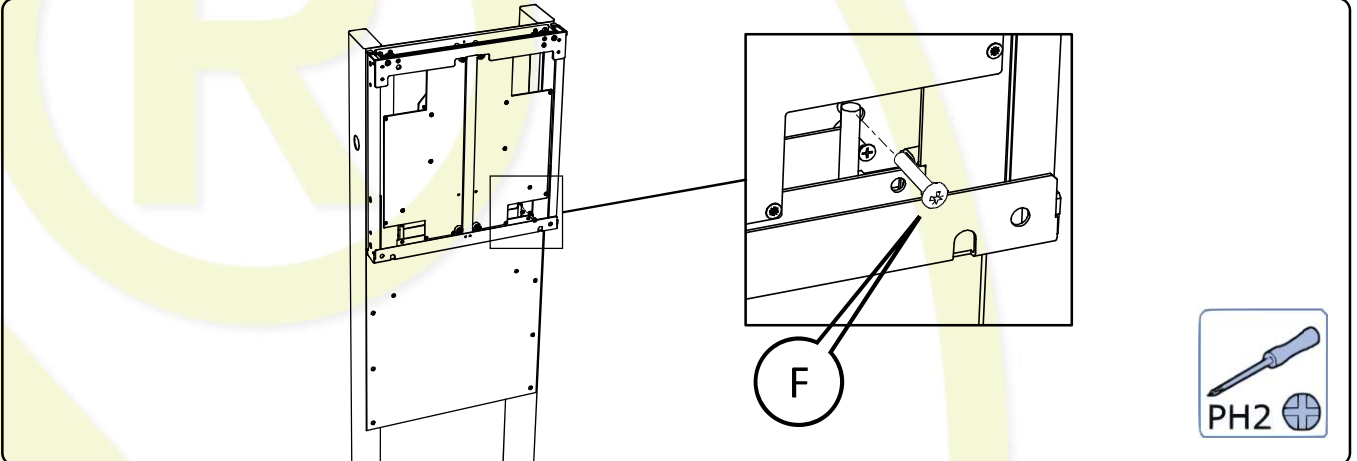

F

PH2

6

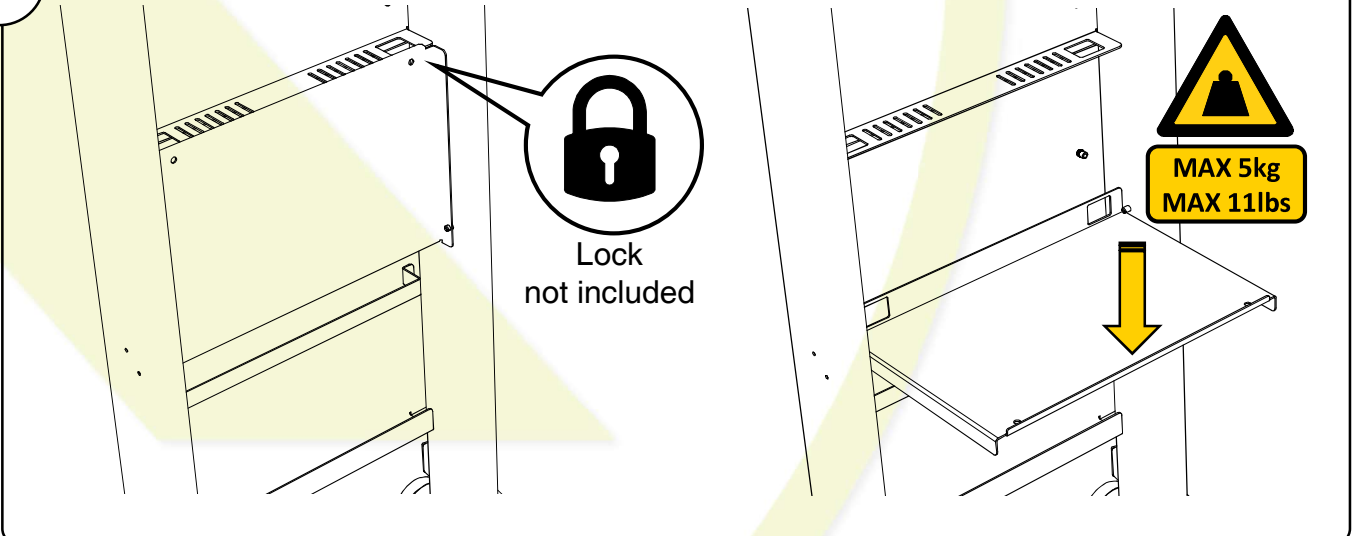

Lock not included

Warning: Heavy load

MAX 5kg
MAX 11lbs

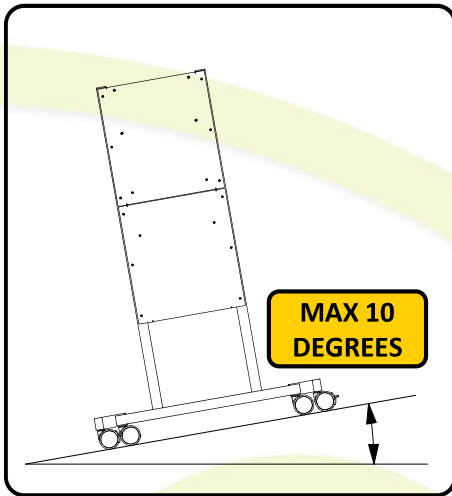

WARNING MAXIMUM SLOPE

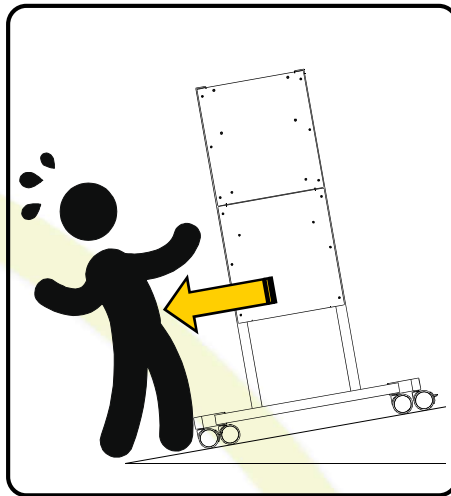

WARNING DO NOT PULL DOWN SLOPE

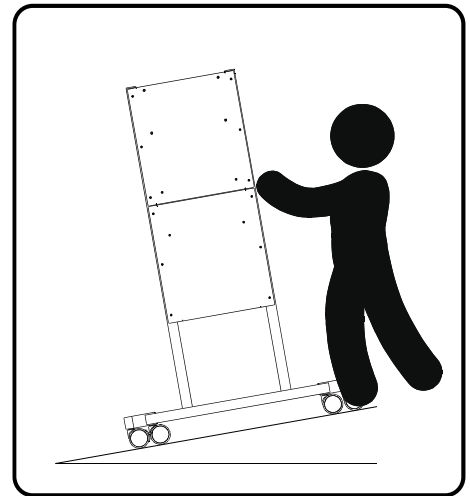

STAY ABOVE CART WHEN MOVING DOWN SLOPE



CAUTION

This cart is intended for use with a BalanceBox® height adjustable mount and flat screen or touchscreen TV or Interactive whiteboard weighing not more than:

200 pounds (90 kg).

Use with other products may result in instability causing possible injury.



CAUTION

“This cart is Intended for use only with the maximum weights indicated. Use with products heavier than the maximum weights indicated may result in instability causing possible injury.”