

User Manual

Model 2194

Digital Storage Oscilloscope



Safety Summary

The following safety precautions apply to both operating and maintenance personnel and must be followed during all phases of operation, service, and repair of this instrument.

WARNING

Before applying power to this instrument:

- Read and understand the safety and operational information in this manual.
- Apply all the listed safety precautions.
- Verify that the voltage selector at the line power cord input is set to the correct line voltage. Operating the instrument at an incorrect line voltage will void the warranty.
- Make all connections to the instrument before applying power.
- Do not operate the instrument in ways not specified by this manual or by B&K Precision.

Failure to comply with these precautions or with warnings elsewhere in this manual violates the safety standards of design, manufacture, and intended use of the instrument. B&K Precision assumes no liability for a customer's failure to comply with these requirements.

Category rating

The IEC 61010 standard defines safety category ratings that specify the amount of electrical energy available and the voltage impulses that may occur on electrical conductors associated with these category ratings. The category rating is a Roman numeral of I, II, III, or IV. This rating is also accompanied by a maximum voltage of the circuit to be tested, which defines the voltage impulses expected and required insulation clearances. These categories are:

Category I (CAT I): Measurement instruments whose measurement inputs are not intended to be connected to the mains supply. The voltages in the environment are typically derived from a limited-energy transformer or a battery.

Category II (CAT II): Measurement instruments whose measurement inputs are meant to be connected to the mains supply at a standard wall outlet or similar sources. Example measurement environments are portable tools and household appliances.

Category III (CAT III): Measurement instruments whose measurement inputs are meant to be connected to the mains installation of a building. Examples are measurements inside a building's circuit breaker panel or the wiring of permanently-installed motors.

Category IV (CAT IV): Measurement instruments whose measurement inputs are meant to be connected to the primary power entering a building or other outdoor wiring.

WARNING

Do not use this instrument in an electrical environment with a higher category rating than what is specified in this manual for this instrument.

WARNING

You must ensure that each accessory you use with this instrument has a category rating equal to or higher than the instrument's category rating to maintain the instrument's category rating. Failure to do so will lower the category rating of the measuring system.

Electrical Power

This instrument is intended to be powered from a CATEGORY II mains power environment. The mains power should be 115 V RMS or 230 V RMS. Use only the power cord supplied with the instrument and ensure it is appropriate for your country of use.

Ground the Instrument

WARNING

To minimize shock hazard, the instrument chassis and cabinet must be connected to an electrical safety ground. This instrument is grounded through the ground conductor of the supplied, three-conductor AC line power cable. The power cable must be plugged into an approved three-conductor electrical outlet. The power jack and mating plug of the power cable meet IEC safety standards.

WARNING

Do not alter or defeat the ground connection. Without the safety ground connection, all accessible conductive parts (including control knobs) may provide an electric shock. Failure to use a properly-grounded approved outlet and the recommended three-conductor AC line power cable may result in injury or death.

WARNING

Unless otherwise stated, a ground connection on the instrument's front or rear panel is for a reference of potential only and is not to be used as a safety ground. Do not operate in an explosive or flammable atmosphere.

WARNING

Do not operate the instrument in the presence of flammable gases or vapors, fumes, or finely-divided particulates.

WARNING

The instrument is designed to be used in office-type indoor environments. Do not operate the instrument

- In the presence of noxious, corrosive, or flammable fumes, gases, vapors, chemicals, or finely-divided particulates.
- In relative humidity conditions outside the instrument's specifications.
- In environments where there is a danger of any liquid being spilled on the instrument or where any liquid can condense on the instrument.
- In air temperatures exceeding the specified operating temperatures.
- In atmospheric pressures outside the specified altitude limits or where the surrounding gas is not air.
- In environments with restricted cooling air flow, even if the air temperatures are within specifications.
- In direct sunlight.

This instrument is intended to be used in an indoor pollution degree 2 environment. The operating temperature range is 0°C to 40°C and 20% to 80% relative humidity, with no condensation allowed. Measurements made by this instrument may be outside specifications if the instrument is used in non-office-type environments. Such environments may include rapid temperature or humidity changes, sunlight, vibration and/or mechanical shocks, acoustic noise, electrical noise, strong electric fields, or strong magnetic fields.

Do not operate instrument if damaged

⚠ WARNING

If the instrument is damaged, appears to be damaged, or if any liquid, chemical, or other material gets on or inside the instrument, remove the instrument's power cord, remove the instrument from service, label it as not to be operated, and return the instrument to B&K Precision for repair. Notify B&K Precision of the nature of any contamination of the instrument.

Clean the instrument only as instructed

⚠ WARNING

Do not clean the instrument, its switches, or its terminals with contact cleaners, abrasives, lubricants, solvents, acids/bases, or other such chemicals. Clean the instrument only with a clean dry lint-free cloth or as instructed in this manual. Not for critical applications

⚠ WARNING

This instrument is not authorized for use in contact with the human body or for use as a component in a life-support device or system.

Do not touch live circuits

⚠ WARNING

Instrument covers must not be removed by operating personnel. Component replacement and internal adjustments must be made by qualified service-trained maintenance personnel who are aware of the hazards involved when the instrument's covers and shields are removed. Under certain conditions, even with the power cord removed, dangerous voltages may exist when the covers are removed. To avoid injuries, always disconnect the power cord from the instrument, disconnect all other connections (for example, test leads, computer interface cables, etc.), discharge all circuits, and verify there are no hazardous voltages present on any conductors by measurements with a properly-operating voltage-sensing device before touching any internal parts. Verify the voltage-sensing device is working properly before and after making the measurements by testing with known-operating voltage sources and test for both DC and AC voltages. Do not attempt any service or adjustment unless another person capable of rendering first aid and resuscitation is present.

Do not insert any object into an instrument's ventilation openings or other openings.

⚠ WARNING

Hazardous voltages may be present in unexpected locations in circuitry being tested when a fault condition in the circuit exists.

⚠ WARNING

Fuse replacement must be done by qualified service-trained maintenance personnel who are aware of the instrument's fuse requirements and safe replacement procedures. Disconnect the instrument from the power line before replacing fuses. Replace fuses only with new fuses of the fuse types, voltage ratings, and current ratings specified in this manual or on the back of the instrument. Failure to do so may damage the instrument, lead to a safety hazard, or cause a fire. Failure to use the specified fuses will void the warranty.

Servicing



Do not substitute parts that are not approved by B&K Precision or modify this instrument. Return the instrument to B&K Precision for service and repair to ensure that safety and performance features are maintained.

For continued safe use of the instrument

- Do not place heavy objects on the instrument.
- Do not obstruct cooling air flow to the instrument.
- Do not place a hot soldering iron on the instrument.
- Do not pull the instrument with the power cord, connected probe, or connected test lead.
- Do not move the instrument when a probe is connected to a circuit being tested.

Working Environment

Environment

This instrument is intended for indoor use and should be operated in a clean, dry environment.

Temperature

Operating: 0°C to +40°C

Non-operation: -20°C to +60°C

Note:

Direct sunlight, radiators, and other heat sources should be taken into account when assessing the ambient temperature.

Humidity

Operating: 85% RH, 40 °C, 24 hours

Non-operating: 85% RH, 65 °C, 24 hours

Altitude

Operating: less than 3 Km

Non-operation: less than 15 Km

Installation (overvoltage) Category

This product is powered by mains conforming to installation (overvoltage) category II.

Degree of Pollution

The oscilloscopes may be operated in environments of Pollution Degree II.

Note:

Degree of Pollution II refers to a working environment which is dry and non-conductive pollution occurs. Occasional temporary conductivity caused by condensation is expected.

IP Rating

IP20 (as defined in IEC 60529).

Compliance Statements

Disposal of Old Electrical & Electronic Equipment (Applicable in the European Union and other European countries with separate collection systems)

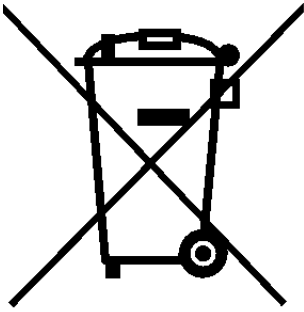

This product is subject to Directive 2002/96/EC of the European Parliament and the Council of the European Union on waste electrical and electronic equipment (WEEE), and in jurisdictions adopting that Directive, is marked as being put on the market after August 13, 2005, and should not be disposed of as unsorted municipal waste. Please utilize your local WEEE collection facilities in the disposition of this product and otherwise observe all applicable requirements.



Safety Symbols

Symbol	Description
	indicates a hazardous situation which, if not avoided, will result in death or serious injury.
	indicates a hazardous situation which, if not avoided, could result in death or serious injury
	indicates a hazardous situation which, if not avoided, will result in minor or moderate injury
	Refer to the text near the symbol.
	Electric Shock hazard
	Alternating current (AC)
	Chassis ground
	Earth ground
	This is the In position of the power switch when instrument is ON.
	This is the Out position of the power switch when instrument is OFF.
	is used to address practices not related to physical injury.

Contents

1	General Information	11
1.1	Product Overview	11
1.2	Features	11
1.3	Contents	11
1.4	Dimensions	12
1.5	Front Panel Overview	13
1.6	Rear Panel Overview	14
1.7	Display Overview	15
2	Getting Started	16
2.1	Input Power Requirements	16
2.2	Fuse Requirements and Replacement	16
2.3	Preliminary Check	17
2.3.1	Verify AC Input Voltage	17
2.3.2	Connect Power	17
2.3.3	Self-Test	18
2.3.4	Self-Cal	18
2.3.5	Check Model and Firmware Version	18
2.3.6	Function Check	19
2.4	Probe Safety	20
3	Vertical Controls	22
3.1	Enable Channel	22
3.2	Channe Menu	22
3.2.1	Channel Coupling	23
3.2.2	Bandwidth Limit	23
3.2.3	Adjust	23
3.2.4	Probe	24
3.2.5	Unit	24
3.2.6	Deskew	25
3.2.7	Invert	25
3.2.8	Offset	25
3.2.9	Trace Visible/Hidden	26
4	Horizontal Control	27
4.1	Horizontal Scale	27
4.2	Zoom	27
4.3	Roll Mode	28
4.4	Trigger Delay	28
5	Sample Control	29
5.1	Run Control	29
5.2	Sampling Theory	29
5.3	Sample Rate	29
5.4	Bandwidth and Sample Rate	30
5.5	Memory Depth	31
5.6	Sampling Mode	32
5.7	Interpolation Method	32
5.8	Acquisition Mode	33
5.9	Average	35
5.10	Eres Acquisition	35
5.11	Horizontal Format	35
5.12	Sequence Mode	37

6	Trigger	38
6.1	Trigger Source	38
6.2	Trigger Mode	39
6.3	Trigger Level	40
6.4	Trigger Coupling	41
6.5	Trigger Holdoff	42
6.6	Noise Rejection	43
6.7	Trigger Types	43
6.7.1	Edge Trigger	44
6.7.2	Slope Trigger	45
6.7.3		46
6.7.4	Video Trigger	48
6.7.5	Window Trigger	51
6.7.6	Interval Trigger	54
6.7.7	Dropout Trigger	56
6.7.8	Runt Trigger	58
6.7.9	Pattern Trigger	60
7	Serial Trigger and Decode	62
7.1	I2C Trigger and Serial Decode	62
7.1.1	Setup for I2C Signals	62
7.1.2	I2C Trigger	63
7.1.3	I2C Serial Decode	66
7.2	SPI Trigger and Serial Decode	67
7.2.1	Setup for SPI Signals	67
7.2.2	SPI Trigger	71
7.2.3	SPI Serial Decode	72
7.3	UART Trigger and Serial Decode	73
7.3.1	Setup for UART Signals	73
7.3.2	UART Trigger	74
7.3.3	UART Serial Decode	75
7.4	CAN Trigger and Serial Decode	77
7.4.1	Setup for CAN Signals	77
7.4.2	CAN Trigger	77
7.4.1	CAN Serial Decode	79
7.5	LIN Trigger and Serial Decode	80
7.5.1	Setup for LIN Signals	80
7.5.2	LIN Trigger	81
7.5.1	Interpreting LIN Decode	83
8	Reference Waveform	84
8.1	Save REF Waveform to Internal Memory	84
8.2	Display REF Waveform	84
8.3	Adjust REF Waveform	85
8.4	Clear Ref Waveform	85
9	Math	86
9.1	Units for Math Waveforms	86
9.2	Math Operators	87
9.2.1	Addition or Subtraction	87
9.2.2	Multiplication and Division	88
9.2.3	FFT Operation	89
9.3	Math Function Operation	93
9.3.1	Differentiate	93
9.3.2	Integrate	94
9.3.3	Square Root	94

10	Cursors	96
10.1	X Cursors	96
10.2	Y Cursors	97
10.3	Make Cursor Measurements	98
11	Measure	99
11.1	Type of Measurement	99
11.1.1	Voltage Measurements	99
11.1.2	Time Measurements	101
11.1.3	Delay Measurements	101
11.2	Automatic Measurement	102
11.3	All Measurement	104
11.4	Gate Measurement	105
11.5	Clear Measurement	105
12	Display	106
12.1	Display Type	106
12.2	Color Display	107
12.3	Persistence	108
12.4	Clear Display	109
12.5	Grid Type	109
12.6	Intensity	109
12.7	Grid Brightness	109
12.8	Transparence	110
13	Save and Recall	111
13.1	Save Type	111
13.2	Internal Save and Recall	112
13.3	External Save and Recall	113
13.4	Disk Management	115
13.4.1	Create a New File or Folder	115
13.4.2	Delete a File or Folder	116
13.4.3	Rename a File or Folder	116
14	System Settings	117
14.1	View System Status	117
14.2	Self Cal	118
14.3	Quick-Cal	118
14.4	Sound	119
14.5	Language	119
14.6	Pass/Fail Test	119
14.6.1	Set and Perform a Pass/Fail Test	120
14.6.2	Save and Recall Test Mask	121
14.7	IO Set	123
14.7.1	LAN	123
14.7.2	USB Device	124
14.8	Update Firmware and Configuration	124
14.9	Do Self-Test	125
14.9.1	Screen Test	125
14.9.2	Keyboard Test	126
14.9.3	LED Test	127
14.10	Screen Saver	128
14.11	Reference Position	129
14.12	Power On Line	129
15	Search	130
15.1	Setting	130
15.2	Results	131

16	Navigate	133
16.1	Time Navigate	133
16.2	History Frame Navigate	133
16.3	Search Event Navigate	133
17	History	134
18	Factory Setup	135
19	Troubleshooting	136
20	Service Information	138
21	LIMITED THREE-YEAR WARRANTY	139

General Information

1.1 Product Overview

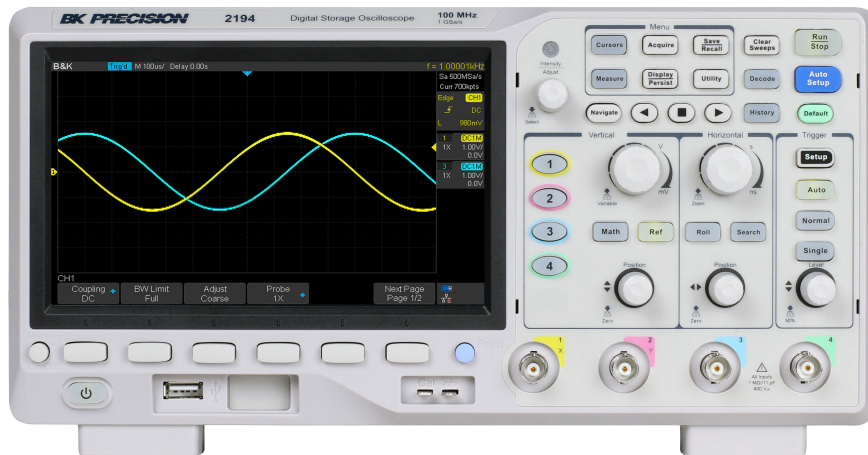

Figure 1.1 2194 Front View

The B&K Precision 2194 digital storage oscilloscope (DSO) is a portable benchtop instrument used for making measurements of signals and waveforms.

This oscilloscope provides 100 MHz of bandwidth in a 4-channel configuration with a maximum sample rate of 1 GSa/s and best-in class memory depth of 14 Mpts.

1.2 Features

- 4 channels with 100 MHz bandwidth
- Single channel real-time sampling rate of up to 1 GSa/s
- 14 Mpts memory depth
- Standard USB host, USBTMC device, and LAN ports

1.3 Contents

Inspect the instrument mechanically and electrically upon receiving it. Unpack all items from the shipping carton, and check for any obvious signs of physical damage that may have occurred during transportation. Report any damage to the shipping agent immediately. Save the original packing carton for possible future reshipment. Every oscilloscope is shipped with the following contents:

- 1 x 2194 Digital Storage Oscilloscope
- AC Power Cord
- USB type A to type B cable.
- 4 x 1:1/10:1 Passive Oscilloscope Probes
- Certificate of Calibration
- Test Report

Note:

Ensure the presence of all the items above. Contact the distributor if anything is missing.

1.4 Dimensions

The 2194 digital storage oscilloscope's dimensions are approximately: 312.00 mm (12.28 in) x 151.00 mm (5.94 in) x 132.60 mm (5.22 in) (W x H x D).

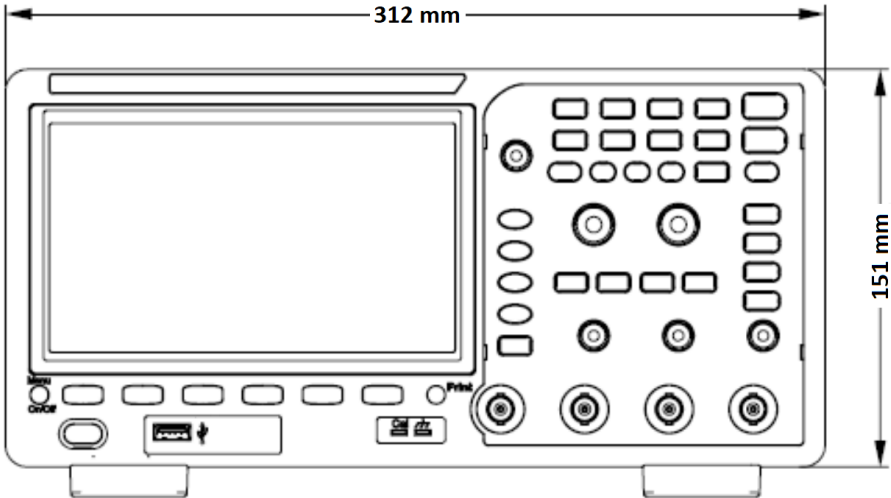

Figure 1.2 Front View Dimensions

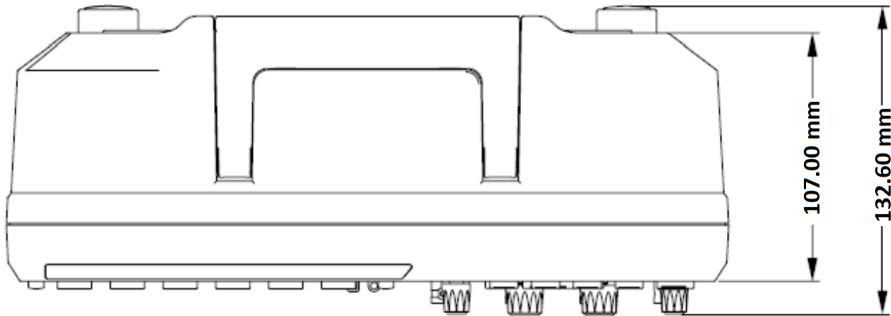

Figure 1.3 Top View Dimensions

1.5 Front Panel Overview

The front panel interface allows for control of the unit.



Figure 1.4 Front Panel

Item	Name	Description
1	LCD Display	Visual presentation of the device function and measurements.
2	Intensity Adjust	Universal knob.
3	Common Function Keys	Used to invoke the functions displayed above them.
4	Numeric Keypad	Used to enter precise values
5	Rotary Knob	Used to navigate menus or configure parameters
6	Navigation Keys	Used to navigate menus. The enter key can be used to select a menu or enter a parameter
7	CH 2 Terminals	Serves as output or input terminals of CH 2 depending on the set functionality
8	Function Keys	Frequently used function such as Home , Trig , Menu , ESC , and On/Off keys
9	CH 1 Terminals	Serves as output or input of CH 1 depending on the set functionality
10	Softkeys	Used to invoke any functions displayed above them.
11	Power Switch	Power the unit ON or OFF
12	Horizontal Control	
13	Auto	Set the trigger mode to auto.
14	Menu On/Off	Enable/disable the menu bar.
15	Softkeys	Used to invoke any functions displayed above them.
16	Print	Shortcut key for the save function.
17	Input Channels	Input channels (1 M Ω BNC)
18	Power Button	Power the unit ON or OFF.
19	USB Host Port	USB port used to connect flash drives. (Type A)
20	Probe Compensation	Probe compensation/ground terminal.

Table 1.1 Front Panel

1.6 Rear Panel Overview



Figure 1.5 Rear Panel Overview

Item	Name	Description
1	Handle	Handle for easy carrying of the instrument.
2	Safety Lock Hole	Locks the instrument to a fixed location using the security lock via the lock hole. The lock is not included.
3	LAN	Connect an ethernet cable to remotely control the unit over the network.
4	USB Interface	Connect a USB type B to type A to remotely control the unit.
5	Pass/Fail or Trigger Out	Output a signal that reflects the current waveform capture rate of the oscilloscope at each trigger or a pass/fail test pulse.
6	AC Power Input & Fuse Box	Houses the fuse as well as the AC input .

Table 1.2 Rear Panel

1.7 Display Overview

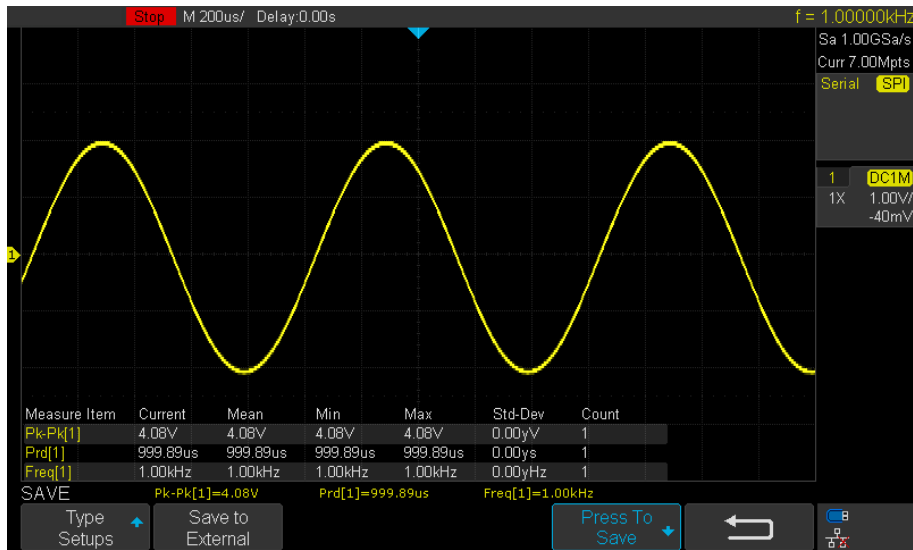

Figure 1.6 Display Overview

Item	Name	Description
1	Trigger Status	Displays the trigger status.
2	USB Host Port Indicator	Indicates that a USB is connected to the instrument.
3	LAN Port Indicator	Indicates the status of the LAN connection.
4	Menu Bar	Displays the available options in the selected menu.

Table 1.3 Display Overview

Getting Started

Before connecting and powering up the instrument, review the instructions in this chapter.

2.1 Input Power Requirements

The oscilloscope has a universal AC input that accepts line voltage and frequency input within:

100 - 240 V (+/- 10%), 50/60 Hz (+/- 5%)
100 - 127 B, 400 Hz
50 W Max

Before connecting to an AC outlet or external power source, be sure that the power switch is in the OFF position and verify that the AC power cord, including the extension line, is compatible with the rated voltage/current and that there is sufficient circuit capacity for the power supply. Once verified, connect the cable firmly.



The included AC power cord is safety certified for this instrument operating in rated range. To change a cable or add an extension cable, be sure that it can meet the required power ratings for this instrument. Any misuse with wrong or unsafe cables will void the warranty.



SHOCK HAZARD:

The power cord provides a chassis ground through a third conductor. Verify that your power outlet is of the three conductor type with the correct pin connected to earth ground.

2.2 Fuse Requirements and Replacement

For continued fire protection at all line voltages replace only with a 1.25 A / 250 V "F" rated, 5 x 20 mm fuse.



For safety, no power should be applied to the instrument while changing line voltage operation. Disconnect all cables connected to the instrument before proceeding.

Check and/or Change Fuse

- Locate the fuse box next to the AC input connector in the rear panel. (See figure 1.5)
- Insert a small flathead screwdriver into the fuse box slit to pull and slide out the fuse box as indicated below.
- Check and replace fuse if necessary. (See figure 2.1)

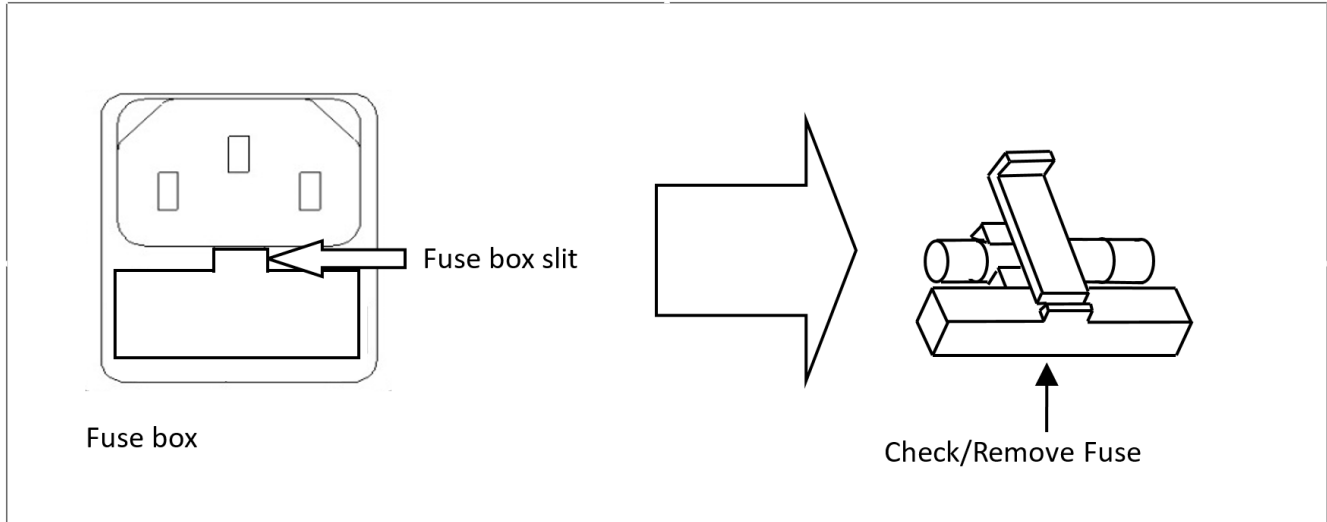

Figure 2.1 Fuse Removal

Any disassembling of the case or changing the fuse not performed by an authorized service technician will void the warranty of the instrument

2.3 Preliminary Check

Complete the following steps to verify that the oscilloscope is ready for use.

2.3.1 Verify AC Input Voltage

Verify proper AC voltages are available to power the instrument.

The AC voltage range must meet the acceptable specification stated in section [Input Power Requirements](#).

2.3.2 Connect Power

Connect the AC power cord to the AC receptacle in the rear panel and press the power switch to turn on the instrument.

The instrument will have a boot up screen while loading, after which the main screen will be displayed.

2.3.3 Self-Test

The instrument has 3 self-test option to test the screen ,keyboard, and the LED back light. To perform the self-test, please refer to the Self Test section for further instructions.

2.3.4 Self-Cal

Self option runs an internal self-calibration procedure that will check and adjust the instrument. To perform the self-calibration refer to the Self-Calibration section for further instructions.

2.3.5 Check Model and Firmware Version

The model and firmware version can be verified from within the menu system.

To view the model and firmware version:

Press the **Utility** button and use the softkeys to select the **System Status** option. The following information will be displayed:

- **Startup Times**
- **Software Version**
- **Uboot-Os Version**
- **FPGA Version**
- **Hardware Version**
- **Product Type**
- **Serial NO**

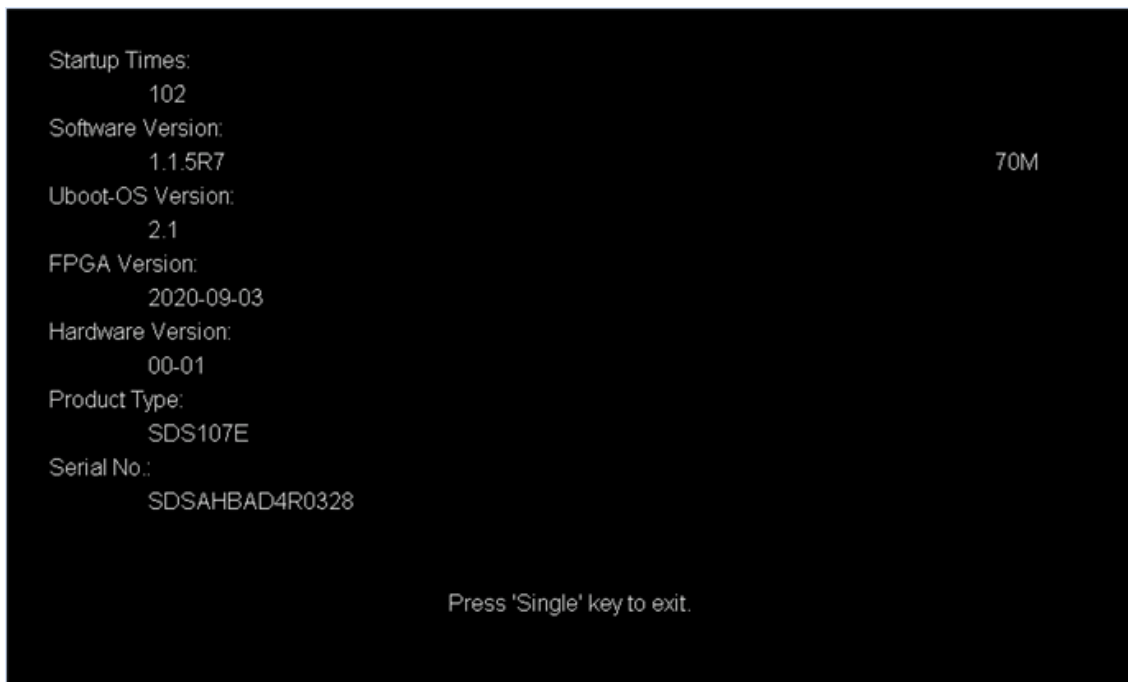

Figure 2.2 System Status

Press the **Single** key to exit.

2.3.6 Function Check

Follow the steps below to do a quick check of the oscilloscope's functionality.

1. Power on the oscilloscope. Press **Default Setup** to show the result of the self-check.
 - The probe default attenuation is 1X.
2. Set the switch to 1X on the probe and connect the probe to channel 1.
 - To do this align the slot in the probe connector with the key on the CH1 BNC, push to connect, and twist to the right to lock the probe in place.
 - Connect the probe tip and reference lead to the Probe Comp connectors.
3. Press the **AUTO** button to show the square wave with 1 kHz frequency and 3V peak to peak .

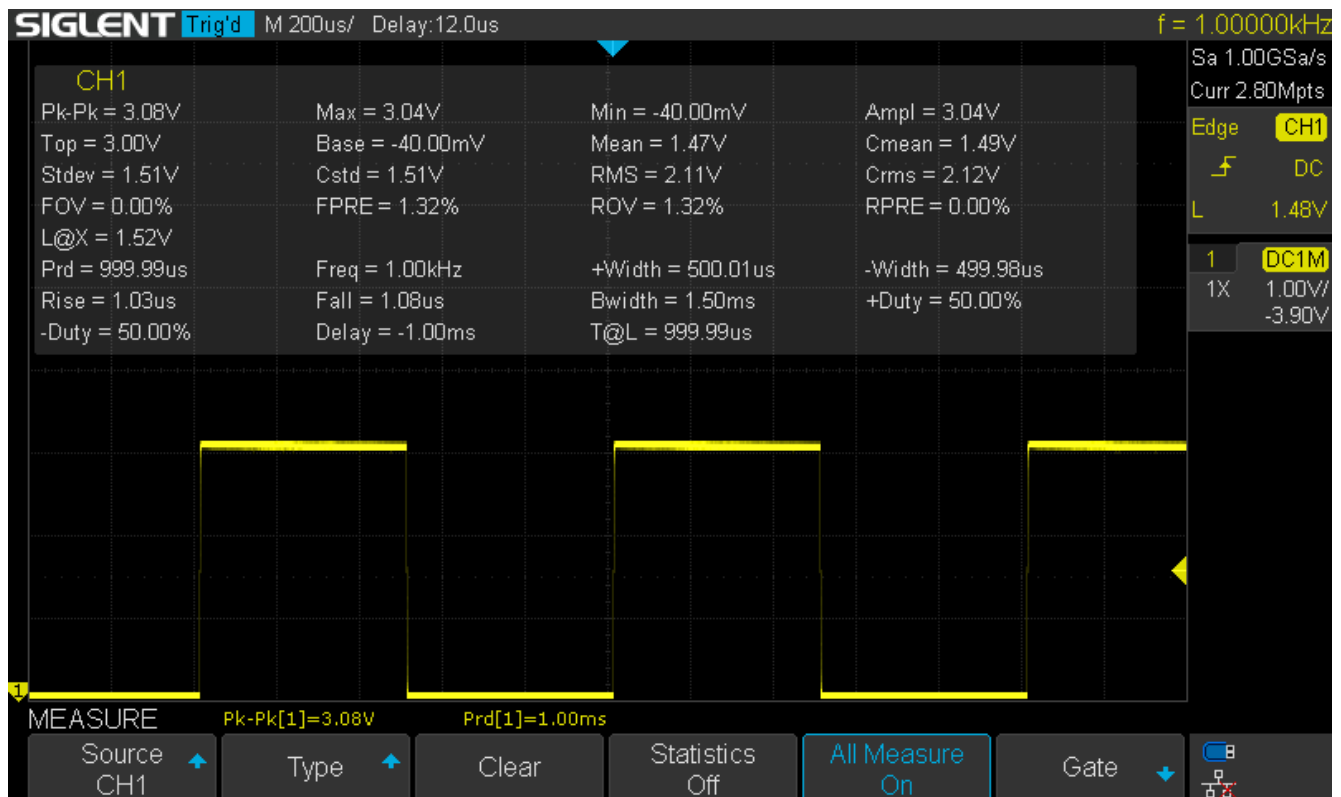

Figure 2.3 3 Vpp Square Wave

4. Repeat steps 1 to 3 for the remaining channels.

2.4 Probe Safety

A guard around the probe body provides a finger barrier for protection from electric shock.

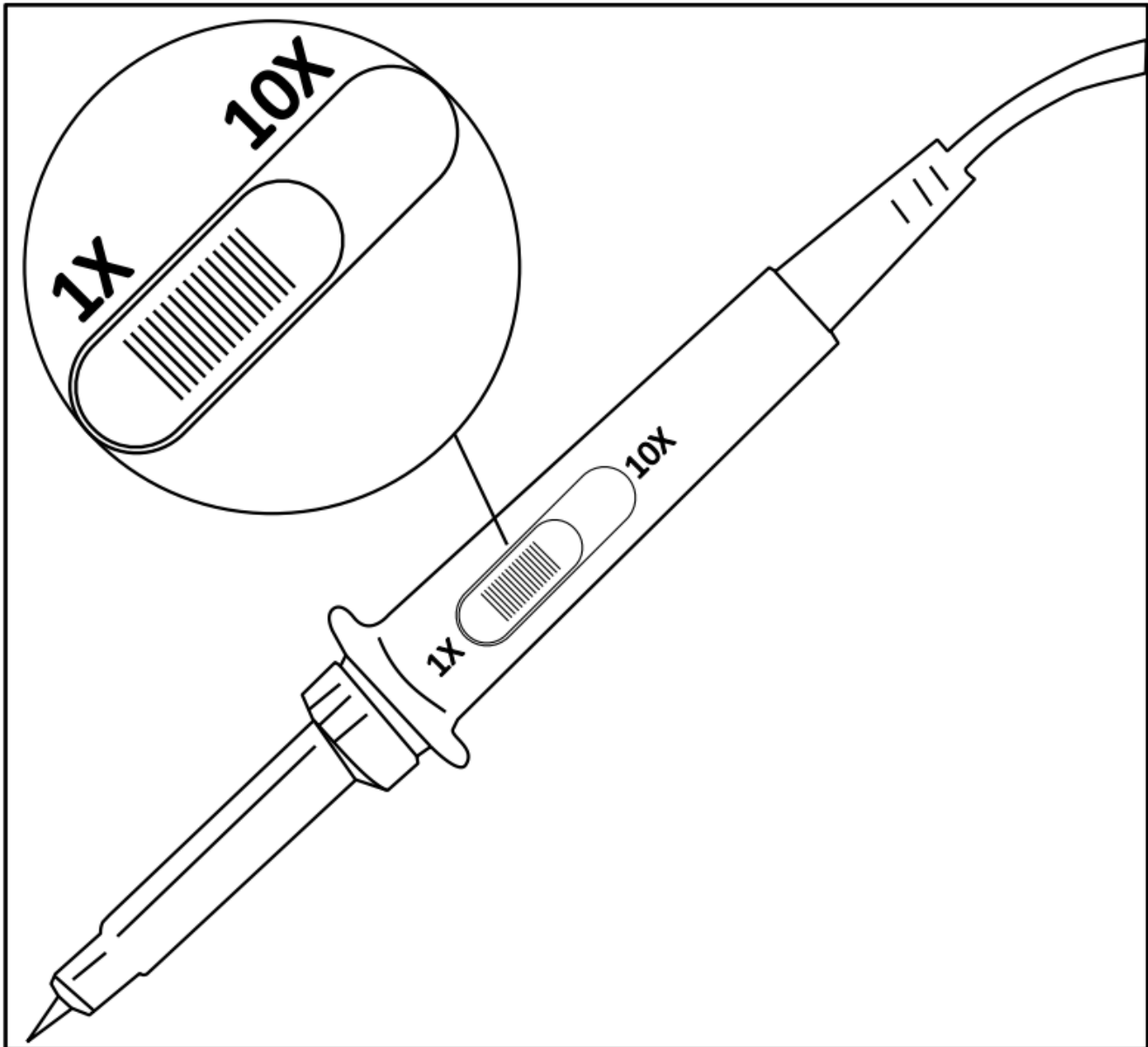

Figure 2.4 Probe

Connect the probe to the oscilloscope and connect the ground terminal to the ground before you take any measurements.



Shock Hazard:

To avoid electric shock when using the probe, keep fingers behind the guard on the probe body. To avoid electric shock while using the probe, do not touch metallic portions of the probe head while it is connected to a voltage source. Connect the probe to the oscilloscope and connect the ground terminal to ground before you take any measurements.

Probe Attenuation

Probes are available with various attenuation factors which affect the vertical scale of the signal. The Probe Check function verifies that the probe attenuation option matches the attenuation of the probe.

Press CH 1 once to open the channel menu. Use the softkeys to navigate to page 1/2 and select the Probe option. Select the probe option that matches the attenuation of the probe.

Note:

The default setting for the Probe option is 1 X.

Verify that the attenuation switch on the probe matches the Probe option in the oscilloscope. Switch settings are 1 X and 10 X.

Probe Compensation

Before taking any measurements using a probe, verify the compensation of the probe and adjust it to match the channel inputs.

To match your probe to the input channel:

1. Set the channel's probe attenuation to 10X.
 - Press the **CH #** key corresponding to the channel the probe is connected to.
 - Use the softkeys to navigate to page 1.
 - Use the softkeys to select **Probe**.
 - Use the **Intensity Adjust** knob to select 10X.
2. Attach the probe tip to the **Compensation Signal Output Terminal 3 V(Cal)** connector and the reference lead to the **Probe Ground terminal** connector.
 - Press the **Auto Setup** key to display the square wave.
3. Check the shape of the displayed waveform.

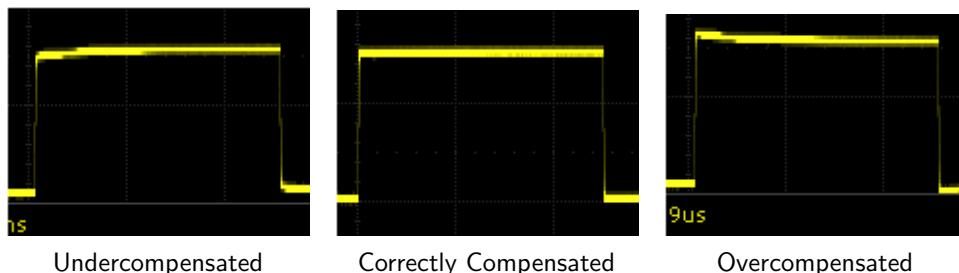

Figure 2.5 Probe Compensation

4. If necessary, adjust your probe's compensation trimmer pot.

Vertical Controls

3.1 Enable Channel

The 2194 provides 4 analog input channels. To enable a channel press the corresponding channel button located on the vertical controls.

The enabled channels can be verified on the right side of the display screen.

To disable a channel:

Press the corresponding channel key. Once the key has been highlighted by the LED press the channel key again.

- Pressing the channel key of the currently selected channel once will disable the channel.



Channels 1 and 2 Enabled

All Channels Enabled

Figure 3.1 Enabled Channels

3.2 Channel Menu

Figure 3.2 shows the channel 2 menu that is displayed after pressing the CH 2 key.



Channel Menu Page 1/2



Channel Menu Page 2/2

Figure 3.2 CH 2 Menu

3.2.1 Channel Coupling

Coupling mode filters out the undesired signals.

Press the corresponding CH button, then use the softkeys to select **Coupling**.

Turn the **Universal Knob** to select the desired coupling method.

Note:

The current coupling method is displayed in the channel label at the right side of the screen. Pressing the **Coupling** softkey continuously switches between the available coupling method.

- **DC Coupling:** The DC and AC components of the signal under test are both passed.
- **AC Coupling:** The DC components of the signal under test are blocked.
- **GND Coupling:** The DC and AC components of the signal under test are both blocked.

3.2.2 Bandwidth Limit

Sets the bandwidth limit to reduce display noise.

Press the CH button of the channel to be configured.

Use the softkeys to select **BW Limit**. (The bandwidth limit will alternate between **Full and 20 M**)

- **Full:** The high frequency components of the signal under test can pass the channel.
- **20 M:** The high frequency components exceeding 20 MHz are attenuated.

3.2.3 Adjust

Adjust the vertical scale sensitivity of the selected channel.

The vertical scale is adjusted using the **Vertical Variable Knob**.

Press the CH button of the channel to be configured.

Use the softkeys to select **Adjust**. (The scale will alternate between **Fine and Coarse**)

If the amplitude of the input waveform is a little bit greater than the full scale under the current scale and the amplitude would be a little bit lower if the next scale is used, fine adjustment can be used to improve the amplitude of waveform display to view signal details.

- **Fine adjustment:** Adjust the vertical scale within a relatively smaller range to improve vertical resolution.
 - For example: 2 V/div, 1.98V/div, 1.96V/div, 1.94 V/div, ...1 V/div.
- **Coarse:** Adjust the vertical scale in a 1-2-5 step.
 - For example: 1 mV/div, 2 mV/div, 5 mV/div, 10 mV/div 200 mV/div, 500 mV/div,... 10 V/div.

The scale information in the channel label at the right side of the screen will change accordingly during the adjustment. The adjustable range of the vertical scale is related to the probe ratio currently set.

Note:

Push the **Vertical Variable Knob** to quickly switch between **Coarse** and **Fine** adjustment.

3.2.4 Probe

Sets the probe attenuation factor to match the type of probe being used.

1. Press the CH button of the channel to be configured.
2. Use the softkeys to select **Probe**.
3. Use the softkeys to select **Probe** once more.
4. Use the **Universal Knob** to select the probe attenuation.

Table 3.1 shows the probe attenuation factors.

Setting	Description
0.1X	.01 : 1
0.2X	.02 : 1
0.5X	.05 : 1
1X	1 : 1
2X	2 : 1
5X	5 : 1
10X	10 : 1
...	...
10000X	10000 : 1

Table 3.1 Attenuation Factor

To customize the probe attenuation factor:

Press the **Probe** softkey, select **Custom**, and then press the Custom softkey.

Use the **Universal Knob** to set the desired probe attenuation ratio.

The range is [1E-6,1E6].

3.2.5 Unit

Selects the amplitude display unit for the selected channel.

The available units are **V** and **A**.

1. Press the CH button of the channel to be configured.
2. Use the softkeys to navigate to page 2/2.
3. Use the softkeys to select **Unit** and alternate between **V** and **A**.

The default unit is **V**.

3.2.6 Deskew

Adjust the difference of phase between the channel.

The Valid range of each channel is ± 100 ns.

1. Press the CH button of the channel to be configured.
2. Use the softkeys to navigate to page 2/2.
3. Use the softkeys to select **Deskew**.
4. Turn the **Universal Knob** to change deskew.
 - Pushing the Universal Knob open the keypad.

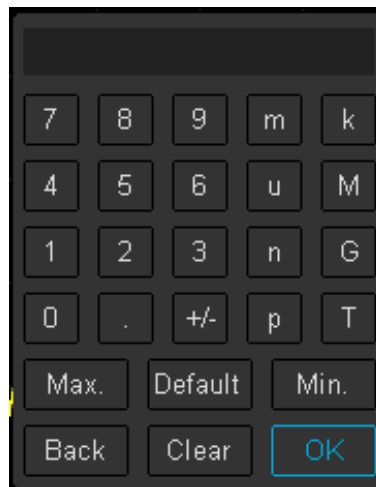

Figure 3.3 Deskew Keypad

3.2.7 Invert

Invert the voltage values of the displayed waveform.

Inverting a channel affects how the channel is displayed, all the results of any math function selected, and measurement functions.

To invert the waveform:

- Press the CH button of the channel to be configured.
- Use the softkeys to navigate to page 2/2.
- Use the softkeys to toggle **Invert** On and Off.

3.2.8 Offset

Offset the vertical position of the displayed waveform.

The Valid range of each channel is ± 100 V.

1. Press the CH button of the channel to be configured.
2. Use the softkeys to navigate to page 2/2.

3. Use the softkeys to select **Offset**.
4. Turn the **Universal Knob** to change deskew.
 - Pushing the Universal Knob open the keypad.

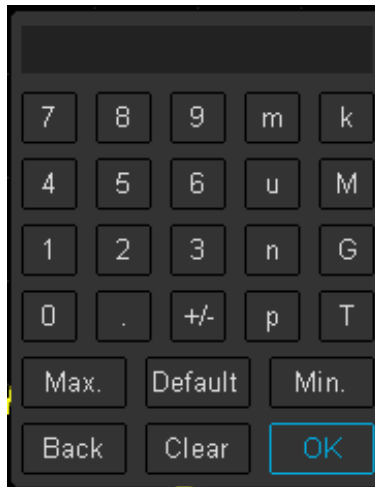

Figure 3.4 Offset Keypad

Note:

The **Vertical Position Knob** can be used to offset the waveform's vertical position without having to enter the channel's menu. Pushing the **Vertical Position Knob** will zero vertical position.

3.2.9 Trace Visible/Hidden

Sets whether waveform of the selected channel is visible or hidden.
To toggle between visible and hidden:

1. Press the CH button of the channel to be configured.
2. Use the softkeys to navigate to page 2/2.
3. Use the softkeys to select **Trace**.

Horizontal Control

4.1 Horizontal Scale

Turn the **Horizontal Scale Knob** to adjust the horizontal time base. Turning the knob clockwise reduces the horizontal time base. Turning the knob counterclockwise increases the time base.

The time base information at the upper left corner of the screen will change accordingly during the adjustment. The 2194 horizontal scale has a range from 2ns/div to 100s/div.

The Horizontal Scale Knob works (in the Normal time mode) while acquisitions are running or when they are stopped.

When in run mode, adjusting the horizontal scale knob changes the sample rate.

When stopped, adjusting the horizontal scale knob lets you zoom into acquired data.

4.2 Zoom

Zoom is a horizontally expanded version of the normal display. You can use Zoom to locate and horizontally expand part of the normal window for a more detailed (higher- resolution) analysis of signals.

Press the **Horizontal Scale Knob** to enable the zoom function, and press the button again to turn disable the function.

When **Zoom** enabled, the display divides in half. The top half of the display shows the normal time base window and the bottom half displays a faster Zoom time base window.

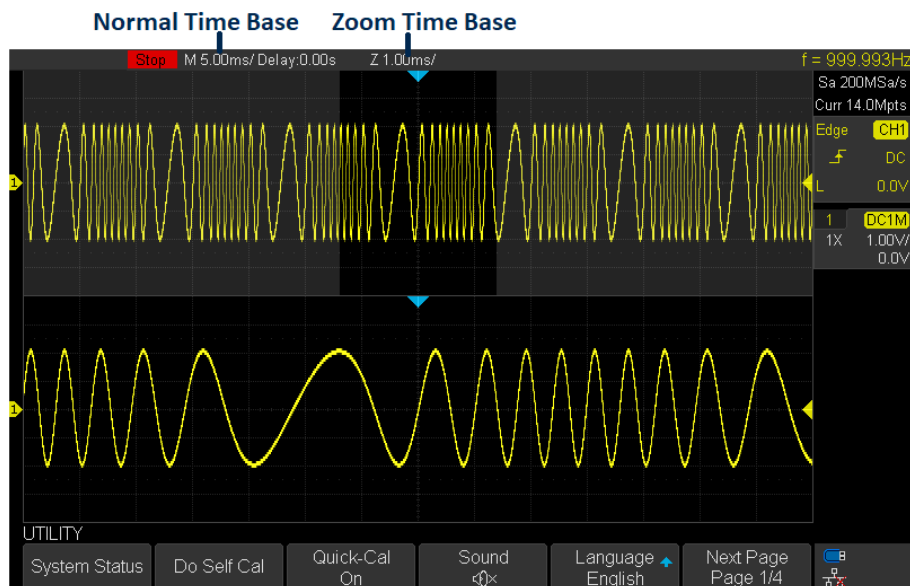

Figure 4.1 Zoom Mode

The area of the normal display that is expanded is outlined with a box and the rest of the normal display is ghosted. The box shows the portion of the normal sweep that is expanded in the lower half.

To change the time base for the zoom window, turn the Horizontal Scale Knob. The **Horizontal Position Knob** sets the left- to- right position of the zoom window.

The delay value, which is the time displayed relative to the trigger point is momentarily displayed in the upper right corner of the display when the **Horizontal Position Knob** is turned. Negative delay values indicate you're looking at a portion of the waveform before the trigger event, and positive values indicate you're looking at the waveform after the trigger event.

To change the time base of the normal window, disable **Zoom**, then turn the **Horizontal Scale Knob**.

4.3 Roll Mode

In **Roll** mode the waveform moves slowly across the screen from right to left. It operates on time base settings of 50 ms/div and slower. If the current time base setting is faster than the 50 ms/div limit, it will be set to 50 ms/div when Roll mode is entered.

In Roll mode there is no trigger. The fixed reference point on the screen is the right edge of the screen and refers to the current moment in time. Events that have occurred are scrolled to the left of the reference point. Since there is no trigger, no pre- trigger information is available.

To enter **Roll** mode press the **Roll** button.

To stop the display, press the **Run/Stop** button.

To clear the display and restart an acquisition in Roll mode, press the **Run/Stop** button again.

To exit **Roll** mode press the **Roll** button.

Note:

Use **Roll** mode on low- frequency waveforms to yield a display much like a strip chart recorder.

4.4 Trigger Delay

Turn the **Horizontal Position Knob** on the front panel to adjust the trigger delay of the waveform. During the modification, waveforms of all the channels would move left or right and the trigger delay message at the upper-right corner of the screen would change accordingly. Press down this knob to quickly reset the trigger delay.

Changing the delay time moves the trigger point (solid inverted triangle) horizontally and indicates how far it is from the time reference point. These reference points are indicated along the top of the display grid.

All events displayed left of the trigger point happened before the trigger occurred. These events are called pre- trigger information, and they show events that led up to the trigger point.

Everything to the right of the trigger point is called post- trigger information. The amount of delay range (pre- trigger and post- trigger information) available depends on the time/div selected and memory depth.

The position knob works (in Normal time mode) while acquisitions are running or when they are stopped.

Sample Control

5.1 Run Control

Press the Run/Stop or the Single key to stop the sampling system of the scope.

- **Running:** When the Run/Stop key is green, the oscilloscope is continuously acquiring data.
 - To stop acquiring data, press the Run/Stop key.
 - When the Run/Stop button is red, data acquisition is stopped.
 - Red "Stop" text is displayed next to the trademark logo in the status line at the top of the display.
 - To start acquiring data, press Run/Stop.
- **Single:** Clears the display, the trigger mode is temporarily set to Normal (to keep the oscilloscope from auto-triggering immediately), the trigger circuitry is armed, the Single key is illuminated, and the oscilloscope waits until a user defined trigger condition occurs before it displays a waveform.
 - When the oscilloscope triggers, the single acquisition is displayed and the oscilloscope is stopped (the Run/Stop button is illuminated in red).
 - Press the Single key again to clear the current waveform and acquire a new one.

Note:

The Single run control lets you view a single shot events without subsequent waveform data overwriting the display. Use Single when you want maximum memory depth for pan and zoom.

5.2 Sampling Theory

The Nyquist sampling theorem states that for a limited bandwidth (band-limited) signal with maximum frequency f_{MAX} , the equally spaced sampling frequency f_S must be greater than twice the maximum frequency f_{MAX} , in order to have the signal be uniquely reconstructed without aliasing.

$$f_{MAX} = F_{S/2} = \text{Nyquist frequency}(f_N) = \text{folding frequency}$$

5.3 Sample Rate

The maximum sample rate of the oscilloscope is 1G Sa/s. The actual sample rate of the oscilloscope is determined by the horizontal scale. See section [Horizontal Scale](#)

The actual sample rate is displayed in the information area at the upper-right corner of the screen.

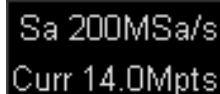

Sa 200MSa/s
Curr 14.0Mpts

Figure 5.1 Actual Sample Rate

The sample rate affect the waveform in the following manner :

- **Waveform Aliasing:** Aliasing occurs when the signal is under-sampled. The signal is distorted by low frequencies falsely being reconstructed from an insufficient number of sample points.

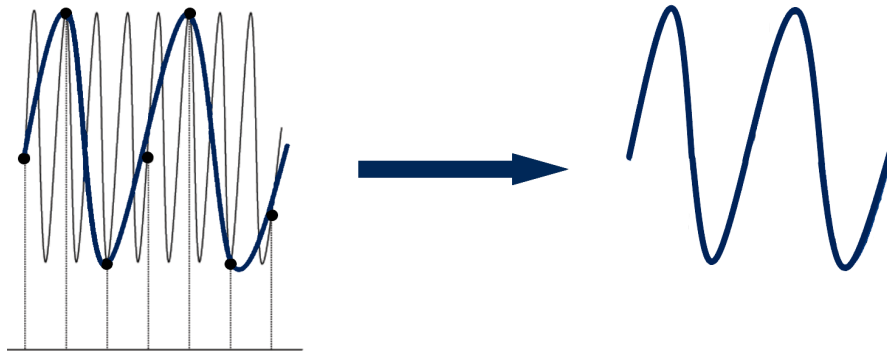

Figure 5.2 Low Sample Rate

5.4 Bandwidth and Sample Rate

An oscilloscope's bandwidth is typically described as the lowest frequency at which input signal sine waves are attenuated by 3 dB (-30% amplitude error).

The sampling theory requires the sample rate to be $f_S = 2 * f_{BW}$. However, the theory assumes there are no frequency components above f_{MAX} (f_{BW} in this case) and it requires a system with an ideal brick-wall frequency response.

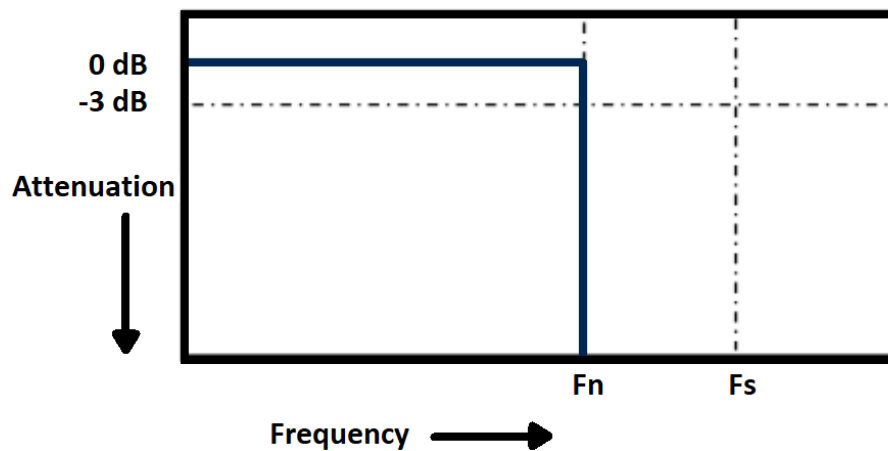

Figure 5.3 Brick-Wall Frequency Response

Digital signals have frequency components about the fundamental frequency (Square waves are made up of sine waves at the fundamental frequency and an infinite number of odd harmonics), and typically, for 500 MHz bandwidths and below, oscilloscopes have a Gaussian frequency response.

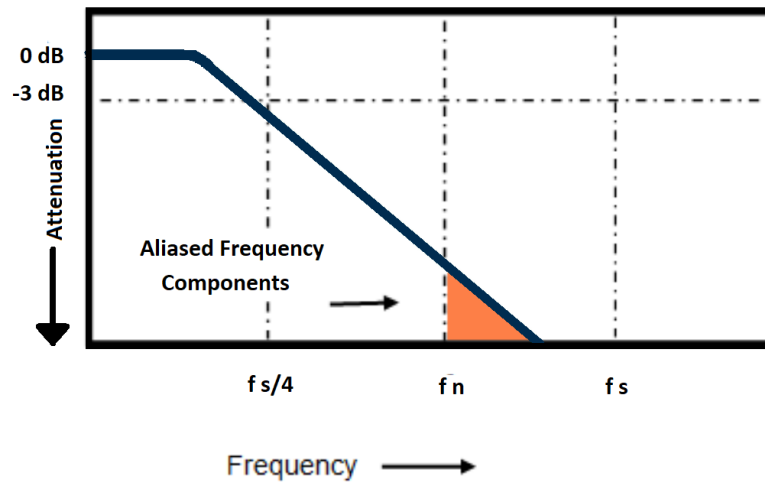

Figure 5.4 Bandwidth Limiting

In practice, an oscilloscope's sample rate should be four or more times its bandwidth: $f_s = 4x f_{BW}$. Doing so causes less aliasing, and aliased frequency components have a great amount of attenuation.

5.5 Memory Depth

Memory Depth refers to the number of waveform points that the oscilloscope can store in a single trigger sample. It reflects the storage ability of the sample memory.

To set the **Memory Depth**:

1. Press the Acquire key.
2. Use the softkeys to select **Mem Depth** (Page 1/2).
3. Turn the **Universal Knob** to navigate the available option.
4. Push the **Universal Knob** to set the selected option.

The actual memory depth is displayed in the information area at the upper right corner of the screen.

Single Channel Mode	Dual Channel Mode	Three or Four Channel Mode
14 k	7 k	3.5 k
140 k	70 k	35 k
1.4 M	700 k	350 k
14 M	7 M	3.5 M

Table 5.1 Maximum Storage Depth

5.6 Sampling Mode

The oscilloscope only supports real-time sampling. In this mode, the oscilloscope samples and displays waveform within a trigger event. The maximum real-time sample rate is 1GSa/s.

Press the RUN/STOP button to stop the sample, the oscilloscope will hold the last display. When stopped the vertical control and horizontal control are used to pan and zoom the waveform.

5.7 Interpolation Method

Under real-time sampling, the oscilloscope acquires the discrete sample values of the waveform being displayed. In general, a waveform of dots display type is very difficult to observe. In order to increase the visibility of the signal, the digital oscilloscope usually uses the interpolation method to display a waveform.

Interpolation method is a processing method to “connect all the sampling points”, and using some points to calculate the whole appearance of the waveform. For real-time sampling interpolation method is used, even if the oscilloscope in a single captures only a small number of sampling points. The oscilloscope can use interpolation method for filling out the gaps between points, to reconstruct an accurate waveform.

To set the **Interpolation Method**:

Press the Acquire button on the front panel to enter the **Acquire Function** menu.

Press the **Interpolation** softkey to toggle between **Sinx/x** and **X**.

- **X**: In the adjacent sample points are directly connected on a straight line. This method is only confined to rebuild on the edge of signals, such as square wave.

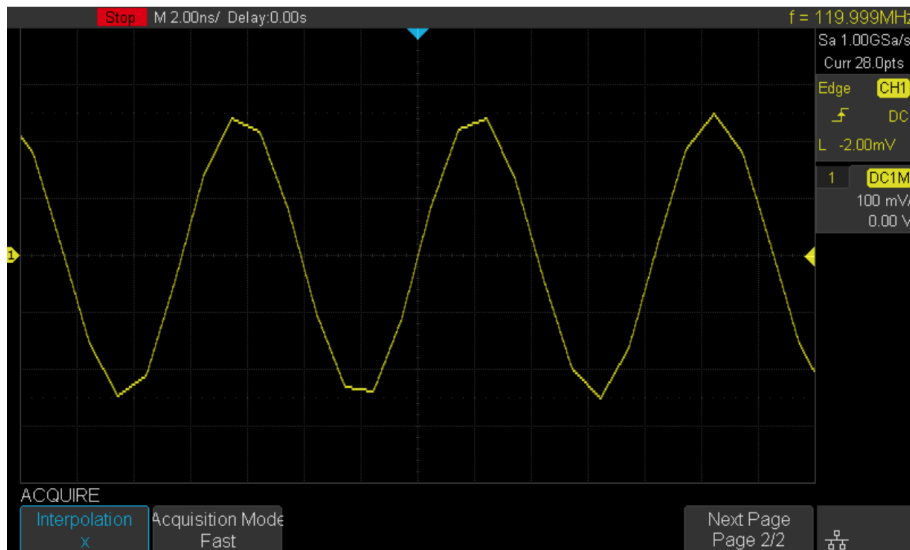

Figure 5.5 Interpolation Method X

- **Sinx/x** Connects the sample points with a curve that has stronger versatility. Sinx interpolation method uses mathematical processing to calculation results in the actual sample interval. This method produces a more realistic regular shape than pure square wave and pulse.

When the sampling rate is 3 to 5 times the bandwidth of the system, the Sinx/s interpolation method is recommended.

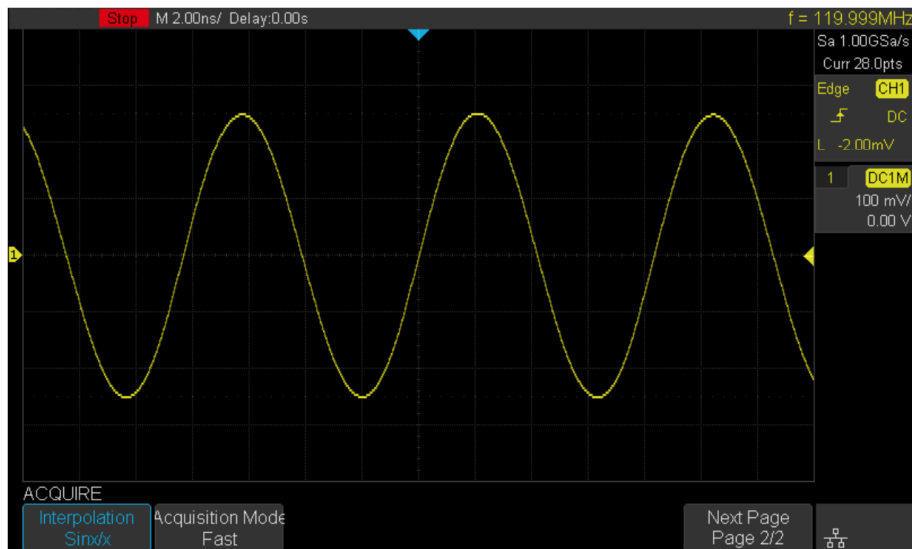

Figure 5.6 Interpolation Method Sinx/x

5.8 Acquisition Mode

The acquisition mode is used to control how to generate waveform points from sample points. The oscilloscope provides the following acquisition mode: Normal, Peak Detect, Average and Eres.

To set the **Acquisition Mode**:

- Press the Acquire key to enter the **Acquire Function** menu.
- Press the **Acquisition** softkey to view the available options.
- Turn the Universal Knob to navigate the available acquisition mode.
- Push the Universal Knob to set the selected method.

Note:

Default mode is **Normal Acquisition**

Normal

In **Normal** mode the oscilloscope samples the signal at equal time interval to rebuild the waveform. For most waveforms, the best display effect can be obtained using this mode.

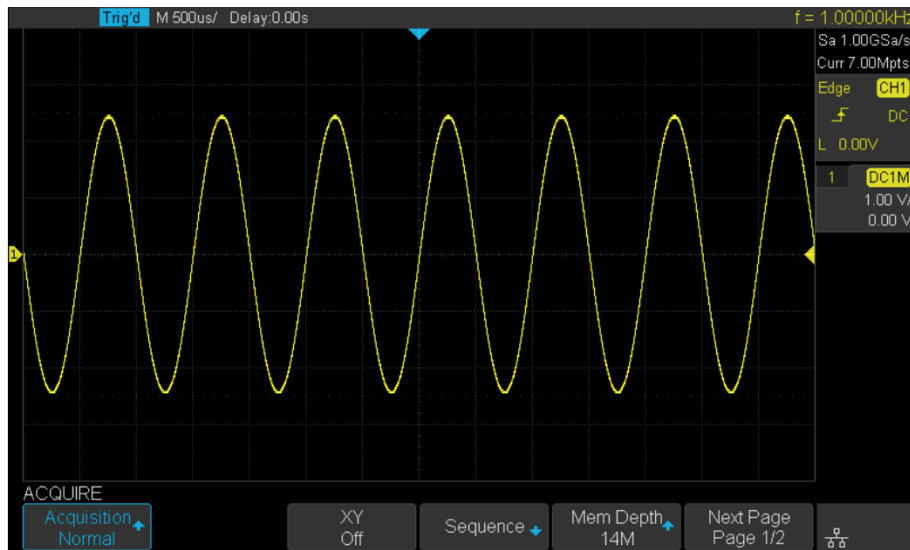

Figure 5.7 Normal Mode

Peak Detect

In **Peak Detect** mode, the oscilloscope acquires the maximum and minimum values of the signal within the sample interval to get the envelope of the signal or the narrow pulse of the signal that might be lost. Peak Detect can prevent aliasing, but the signal is more susceptible to noise.

In **Peak Detect** mode the oscilloscope can display all the pulses with pulse width at least as wide as the sample period.

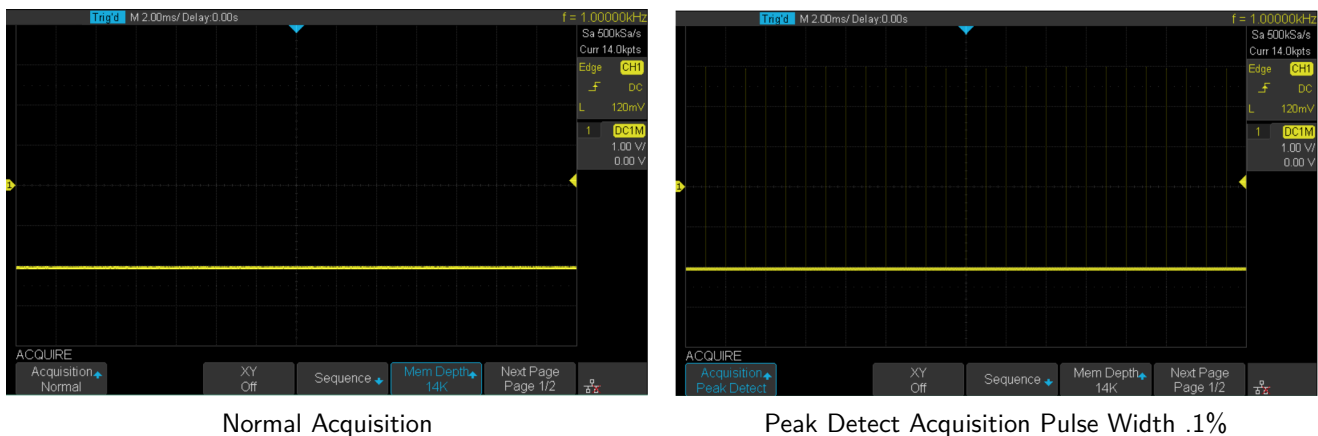

Figure 5.8 Peak Detect Acquisition

5.9 Average

In **Average** mode, the oscilloscope averages the waveforms from multiple samples to reduce the random noise of the input signal and improve the vertical resolution. The greater the number of averages is, the lower the noise will be and the higher the vertical resolution will be.

Average mode slows the response of the displayed waveform.

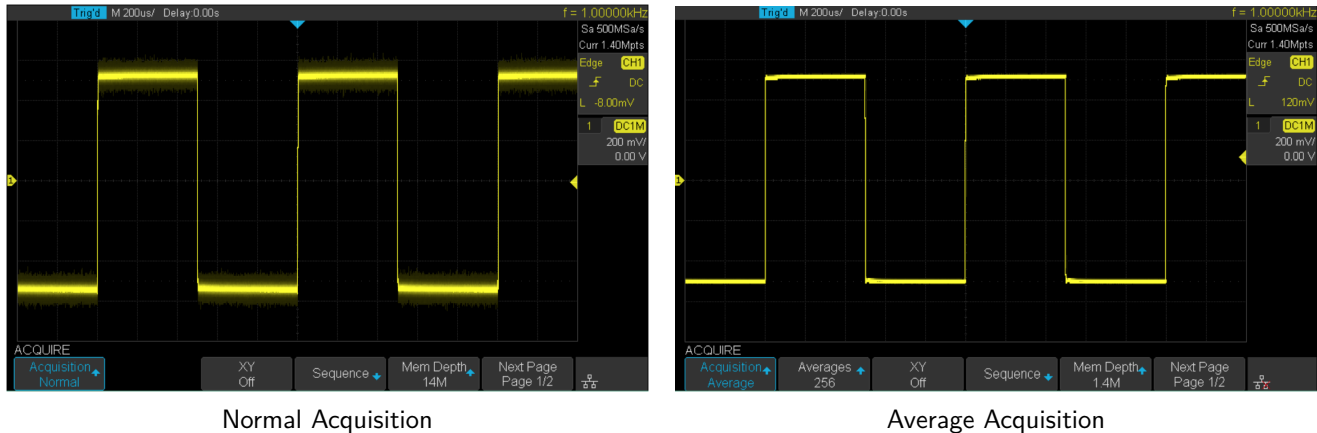

Figure 5.9 Average Acquisition

5.10 Eres Acquisition

Eres mode uses an ultra-sampling technique to average the neighboring points of the sample waveform to reduce the random noise on the input signal and generate smoother waveforms.

Eres mode is generally used when the sample rate of the digital converter is higher than the storage rate of the acquisition memory.

Eres mode can be used on both single-shot and repetitive signals. It does not slow down the waveform update, but it does limit the oscilloscope's real-time bandwidth, because it acts like a low-pass filter.

Note:

Average and **Eres** mode use different averaging methods. The former uses a **Waveform Average** method, the latter uses a **Dot Average** method.

5.11 Horizontal Format

The **XY** mode can be used to compare frequency and phase relationships between two signals.

XY mode can also be used with transducers to display strain versus displacement, flow versus pressure, volts versus current, or voltage versus frequency.

To enable **XY** mode:

1. Press the Acquire key.
2. Press the **XY** softkey to toggle **XY** mode.

Disabled:

When **XY** is disabled, **YT** mode is set. In **YT** mode the display is set to a volt versus time graph, and signal events occurring before the trigger are plotted to the left of the trigger point and signal events after the trigger plotted to the right of the trigger point.

Enabled:

XY mode changes the display to a volt versus volt graph. Channel's 1 amplitude is plotted on the x-axis and channel's 2 amplitude is plotted on the Y-axis.

The phase deviation between two signals with the same frequency can be measured via the Lissajous method. The figure below shows the measurement schematic diagram of the phase deviation.

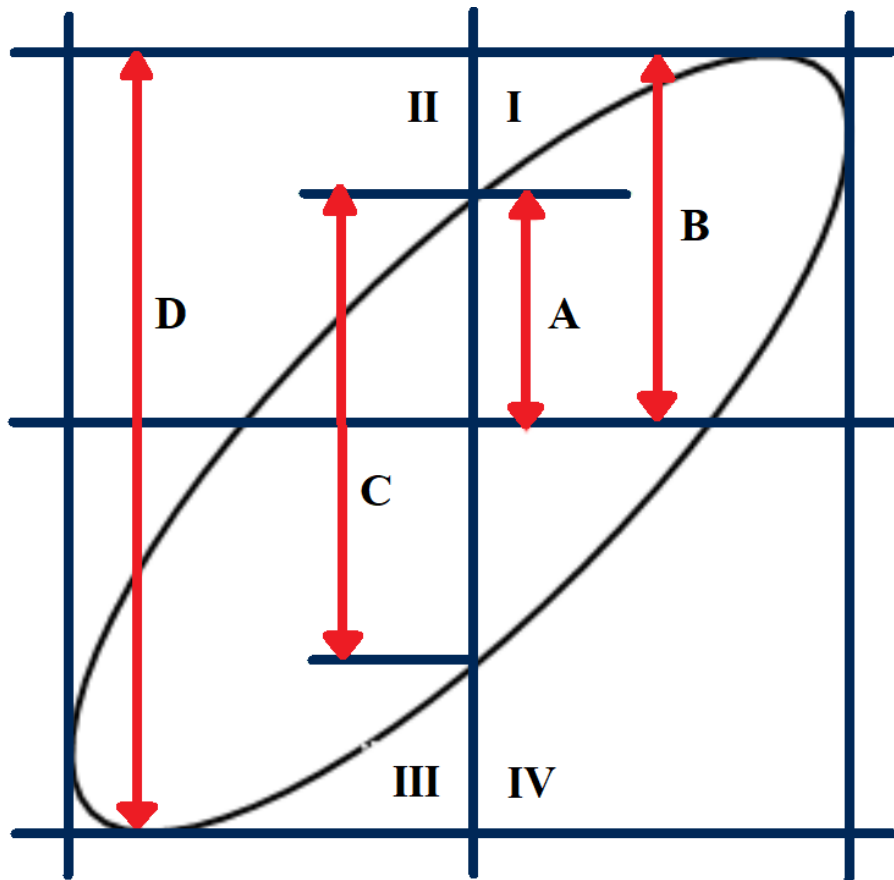

Figure 5.10 Phase Deviation

According to $\sin(\theta) = \left(\frac{A}{B}\right)$ or $\left(\frac{C}{D}\right)$ (where θ is the phase deviation angle between the two channels and the definitions of A, B, C and D are as shown in figure 5.10), the phase deviation angle is obtained using $\theta = \pm \arcsin\left(\frac{A}{B}\right)$ or $\pm \arcsin\left(\frac{C}{D}\right)$.

If the principal axis of the ellipse is within quadrant I and III, the phase deviation angle obtained should be within quadrant I and IV, namely within $(0 \text{ to } \pi/2)$ or $(3\pi/2 \text{ to } 2\pi)$.

If the principal axis of the ellipse is within quadrant II and IV, the phase deviation angle obtained should be within quadrant II and III, namely within $(\pi/2 \text{ to } \pi)$ or $(\pi \text{ to } 3\pi/2)$.

5.12 Sequence Mode

Sequence is an acquisition mode, which does not display waveform during sampling process. It improves the waveform capture rate, the maximal capture rate is 400,000 wfs/s. This allows the 2194 to capture small probability event effectively.

The 2194 runs and fills a memory segment for each trigger event. The oscilloscope continues to trigger until memory is filled, and then display the waveforms on the screen.



Note:

To use the sequence mode, **Acquisition Mode** must be set to **Normal** or **Peak Detect** and **Horizontal Format** must be set to **YT** mode.

To enable sequence mode:

1. Press the **Acquire**.
2. Press the **Sequence** softkey to enter the **Sequence** function menu.
3. Press the **Max Segments** softkey.
 - Turn the Universal Knob to select the desired value.
 - Pressing the Universal Knob will open to numeric keypad to facilitate the input of the desired value.

To replay the acquired sequence:

1. Press the **History** key.
2. Press the **List** softkey to enable the list display.
 - The list records the acquisition time and ΔT of every frame.
3. Press the **Frame No.** softkey.
 - Turn the Universal Knob to select the frame to be displayed.
4. Press the  softkey to replay the waveforms from the current frame to frame 1.
5. Press the  softkey to stop the replay.
6. Press the  softkey to replay the waveforms from the current frame to the last frame.

Trigger

For triggering, certain condition can be set according to the requirement and when a waveform in the waveform stream meets this condition. Digital oscilloscope, display a waveform continuously regardless of the trigger stability, but only stable trigger can ensures stable display.

The trigger circuit ensures that every time base sweep or acquisition starts from the input signal and the user-defined trigger condition, namely every sweep is synchronous to the acquisition and the waveforms acquired overlap to display stable waveform.

Figure 6.1 demonstrates how the position of the trigger event determines the reference time point and the delay setting.

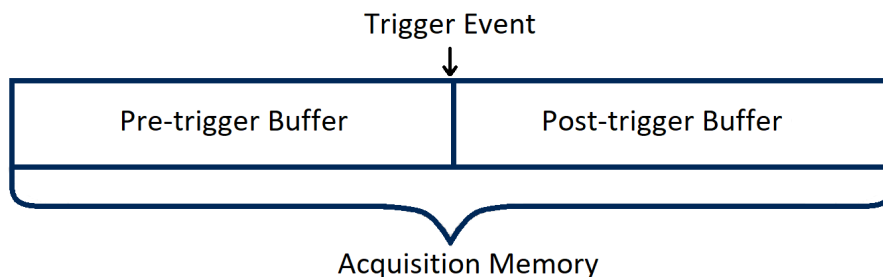

Figure 6.1 Acquisition Memory

A trigger setup tells the oscilloscope when to acquire and display data. Trigger setting are based on the features of the input signal, therefore knowledge of the signal under test is required to quickly capture the desired waveform.

6.1 Trigger Source

The 2194 trigger source includes four analog channels and AC line.

To set the trigger source:

1. Press the Setup key to enter the **Trigger** menu.
2. Press the **Source** softkey to display the available trigger sources.
 - Turn the Universal Knob or continuously press the **Source** softkey to navigate the available sources.



Available Trigger Sources Selected Trigger Source

Figure 6.2 Trigger Source

The currently selected trigger source is displayed at the upper right corner of the screen.

Analog Channel Input

Signals input from the analog channels can all be used as a trigger source.

AC Line

The trigger signal is obtained from the AC power input of the oscilloscope. This kind of signals can be used to display the relationship between signals (such as illuminating device) and power (power supply device). For example, it is mainly used in related measurement of the power industry to stably trigger the waveform output from the transformer of a transformer substation.

Note:

To select stable channel waveform as the trigger source to stabilize the display.

6.2 Trigger Mode

The oscilloscope's trigger mode includes Auto, Normal, and Single. Trigger mode affects the way in which the oscilloscope searches for the trigger.

After the oscilloscope starts running, the oscilloscope operates by first filling the pre-trigger buffer. It starts searching for a trigger after the pre-trigger buffer is filled and continues to flow data through this buffer while it searches for the trigger. While searching for the trigger, the oscilloscope overflows the pre-trigger buffer and the first data put into the buffer is first pushed out (First Input First Out, FIFO).

When a trigger is found, the pre-trigger buffer contains the events that occurred just before the trigger. Then, the oscilloscope fills the post-trigger buffer and displays the acquisition memory.

To select the trigger mode press the key corresponding to the desired mode.

Auto

If the specified trigger conditions are not found, the triggers are forced and acquisitions are made so that signal activity is displayed on the oscilloscope.

Auto trigger mode is appropriate when:

- Checking DDC signals or signals with unknown levels or activity.
- When trigger conditions occur often enough that forced triggers are unnecessary.

Normal

Triggers and acquisitions only occur when the specified trigger conditions are found. Otherwise, the oscilloscope holds the original waveform and waits for the next trigger.

Normal trigger mode is appropriate when:

- Only specific events specified by the trigger settings are to be acquired.
- Triggering on an infrequent signal from a serial bus such as I2C, SPI, CAN, LIN, etc. or another signal that arrives in bursts.

Note:

Normal trigger mode stabilizes the display by preventing the oscilloscope from auto-triggering.

Single

The oscilloscope waits for a trigger and displays the waveform when the trigger condition is met, the acquisition is stopped when the trigger conditions are met.

Single trigger mode is appropriate when:

- Capturing a single event or a periodic signal.
- Capturing a burst or other unusual signals.

Note:

The oscilloscope can be forced to trigger by pressing the Single button twice. The trigger status in the upper left corner of the screen will be displayed as "FStop".

6.3 Trigger Level

Trigger level and slope define the trigger point.

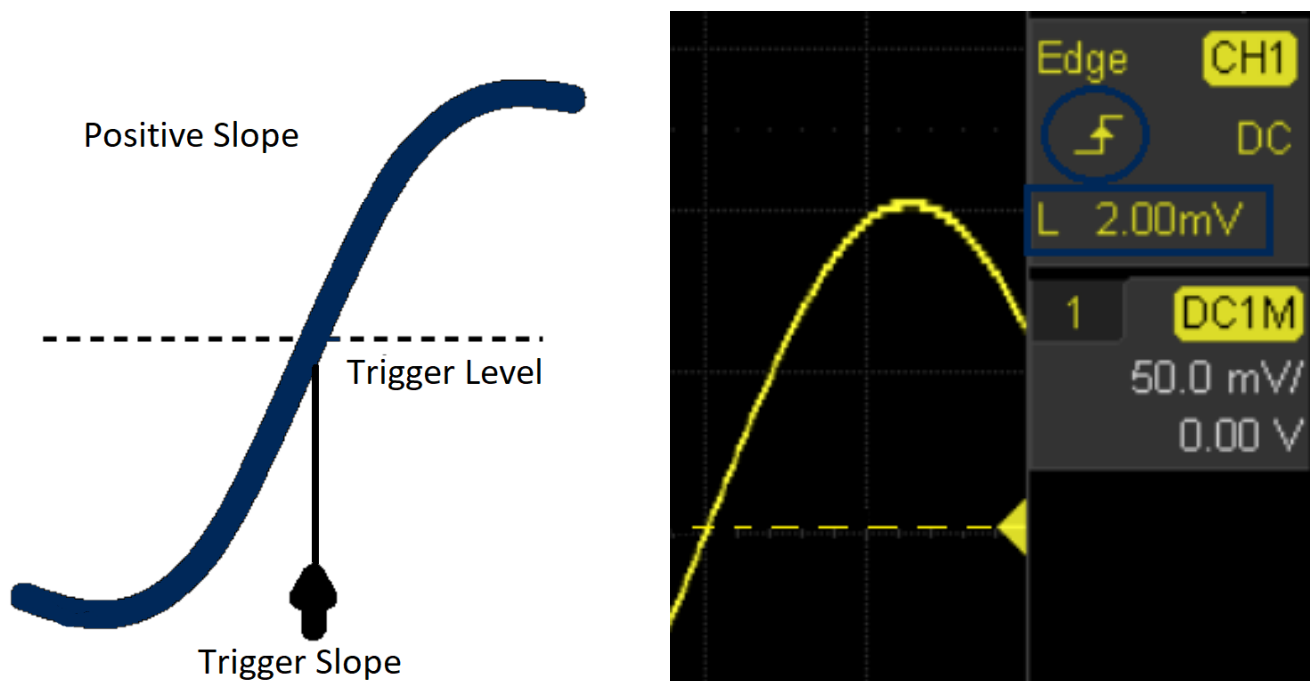



Figure 6.3 Trigger Point

Turn the Trigger Level Knob to adjust the trigger level for the selected analog channel.

Pushing the Trigger Level Knob sets the trigger level to 0 when AC Coupling is selected.

The position of the trigger level for the analog channel is indicated by the trigger level icon  (if the analog channel is on). The value of the analog channel trigger level is displayed in the upper-right corner of the display.

The example in figure 6.3 highlights the Positive edge slope at a trigger level of 2.00 mV.

6.4 Trigger Coupling

To set the trigger coupling:

1. Press the Setup key to enter the **Trigger** menu.
2. Press the **Coupling** softkey to display the available options.
3. Turn the Universal Knob or press the **Coupling** softkey continually to navigate the available modes.
4. Push the Universal Knob to set the selected mode.

Note:

Trigger coupling has nothing to do with the channel coupling.

The oscilloscope provides 4 kinds of trigger coupling modes:

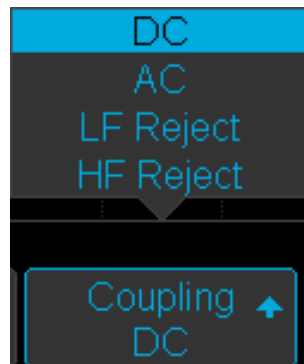

Figure 6.4 Trigger Coupling

DC

Allows both AC and DC components of the waveform into the trigger path.

AC

Blocks all the DC components and attenuate signals lower than 8 Hz. Use AC coupling to get a stable edge trigger when your waveform has a large DC offset.

LF Reject

Block the DC components and reject the low frequency components lower than 2 MHz. Low frequency reject removes any unwanted low frequency components from a trigger waveform, such as power line frequencies, etc. that can interfere with proper triggering. Use LF Reject coupling to get a stable edge trigger when your waveform has low frequency noise.

HF Reject

Reject the high frequency components higher than 1.2 MHz.

6.5 Trigger Holdoff

Trigger holdoff can be used to add an additional, user-defined delay to the re-arming of the trigger circuit. This provides control over how rapidly, or how often, the oscilloscope can be triggered. The oscilloscope will not trigger until the holdoff time expires.

Use the holdoff to trigger on repetitive waveforms that have multiple edges (or other events) between waveform repetitions. You can also use holdoff to trigger on the first edge of a burst when you know the minimum time between bursts.

For example, to get a stable trigger on the repetitive pulse burst shown in figure 6.5 set the holdoff time to be >200 ns but <400 ns.

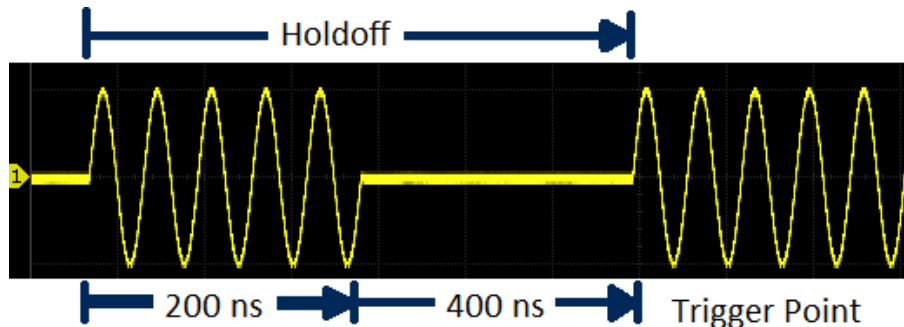

Figure 6.5 Holdoff

The correct holdoff setting is typically slightly less than one repetition of the waveform. Set the holdoff to this time to generate a unique trigger point for a repetitive waveform.

Note:

Only edge trigger and serial trigger have holdoff option. The holdoff is adjustable from 100 ns to 1.5 s.

To find the repetition of the waveform:

1. Press the Stop key to stop data acquisition.
2. Turn the Horizontal Position Knob and the Horizontal Scale Knob to find where the waveform repeats.
3. Measure the time using the cursors function.
4. Set the **Holdoff** time.

To set the **Holdoff** time.

1. Press the Setup key to enter the **Trigger** menu.
2. Press the **Holdoff Close** softkey to enable Holdoff.
3. Turn the Universal Knob to set the desired holdoff time.
 - Push the Universal Knob to open the numeric keypad.

Note:

Adjusting the time scale and horizontal position will not affect the holdoff time.

6.6 Noise Rejection

Noise Rejection adds additional hysteresis to the trigger circuitry. By increasing the trigger hysteresis band, the possibility of triggering on noise is decreased, however the trigger sensitivity is also decreased. A larger signal is required to trigger the oscilloscope when **Noise Rejection** is enabled.

To enable **Noise Rejection**:

1. Press the Setup key to enter the **Trigger** menu.
2. Press the **Noise Reject** softkey to toggle between On and Off.

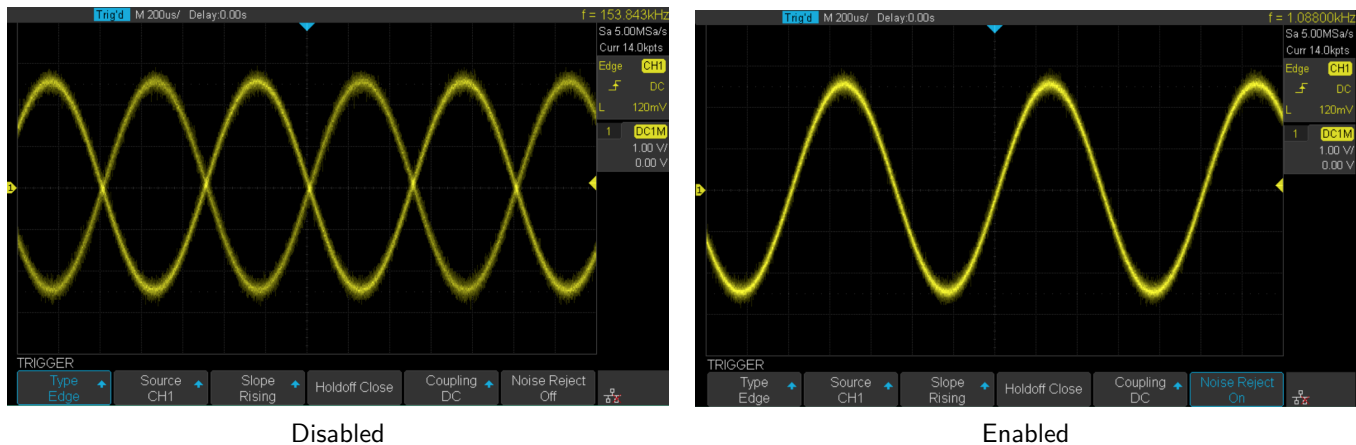

Figure 6.6 Noise Reject

If the signal being probed is noisy, set up the oscilloscope to reduce the noise in the trigger path and on the displayed waveform. First, stabilize the displayed waveform by removing the noise from the trigger path. Second, reduce the noise on the displayed waveform.

- Obtain a stable display.
- Remove the noise from the trigger path setting Trigger coupling to LF Reject, **HF Reject**, or enabling **Noise Reject**.
- Set the **Acquisition** mode to **Average** to reduce noise.

6.7 Trigger Types

The 2194 provides the following trigger types :

- **Edge Trigger**
- **Pulse Trigger**
- **Window Trigger**
- **Dropout Trigger**
- **Pattern Trigger**
- **Slope Trigger**
- **Video Trigger**
- **Interval Trigger**
- **Runt Trigger**
- Serial Trigger



Figure 6.7 Trigger Type

6.7.1 Edge Trigger

Edge trigger distinguishes the trigger points by seeking the specified edge (rising, falling, alter) and trigger level.

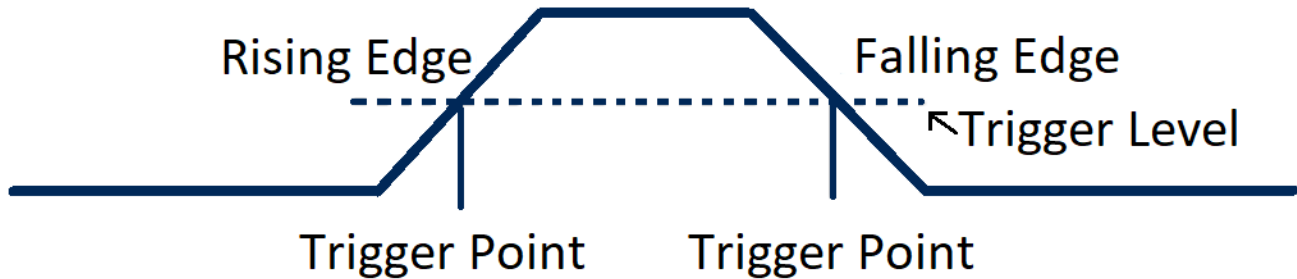

Figure 6.8 Edge Trigger Point

1. Press the Setup key to enter the **Trigger** menu.
2. Press the **Type** softkey to display the available trigger types.
3. Turn the Universal Knob or press the **Type** softkey to navigate the available options.
4. Press the **Slope** softkey.
 - Turn the Universal Knob to set the desired trigger edge (rising, falling or alter)
5. Turn the Trigger Level Knob to adjust the trigger level.

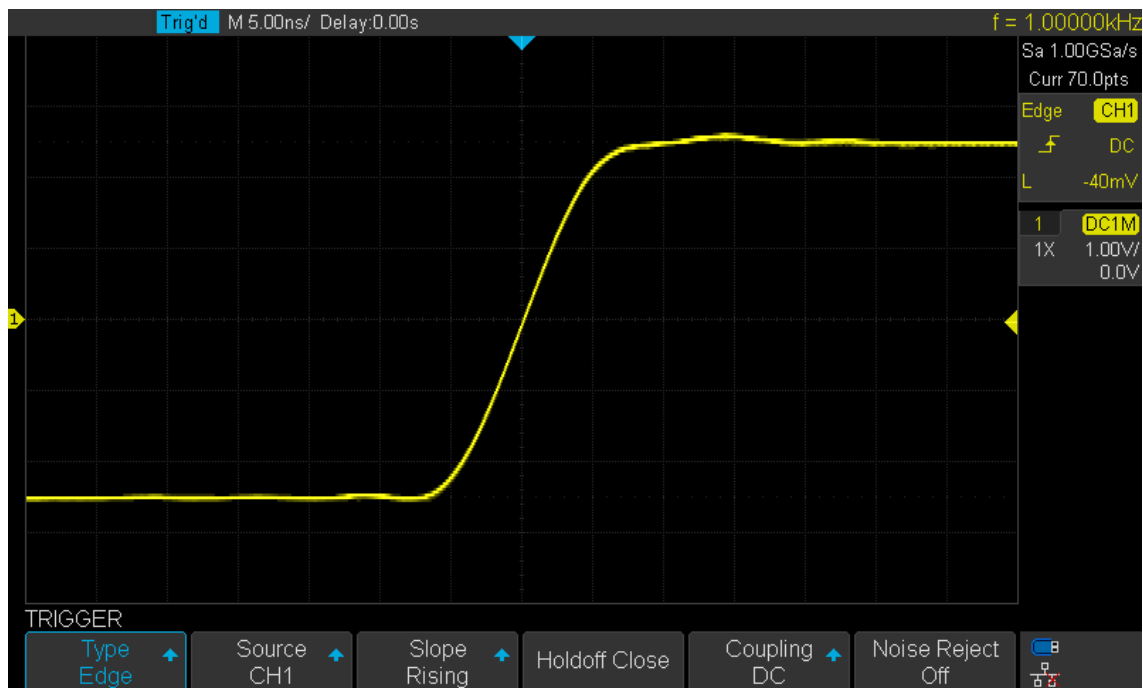

Figure 6.9 Edge Trigger

Holdoff, **coupling** and **noise reject** can be set in edge trigger.

6.7.2 Slope Trigger

The slope trigger looks for a rising or falling transition from one level to another level in greater than or less than a certain amount of time.

In the oscilloscope, positive slope time is defined as the time difference between the two crossing points of trigger level A and B with the positive edge as shown in the figure below.

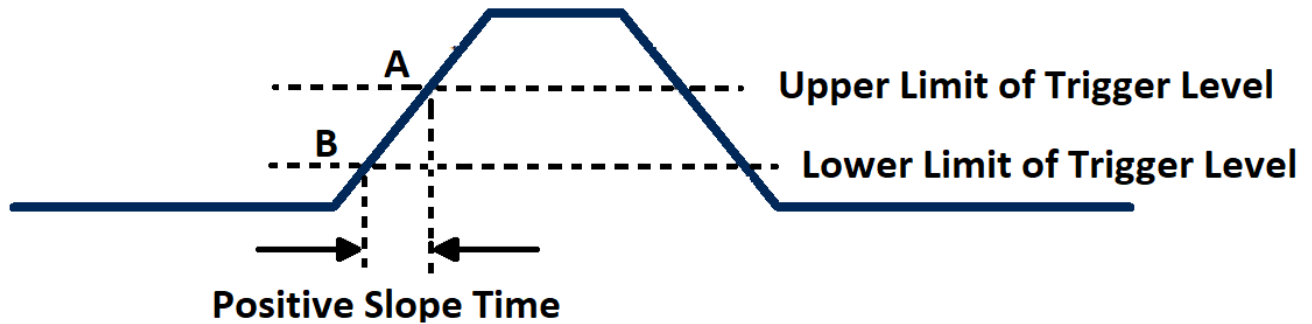

Figure 6.10 Slope Trigger

1. Press the Setup key to enter the **Trigger Menu**.
2. Press the **Type** softkey to view the available trigger types.
3. Turn the Universal Knob
4. Select **Slope** and push the Universal Knob to select the trigger source.
5. Press the **Slope** softkey and turn the Universal Knob to set select the desired trigger edge (rising or falling)
 - Push down the knob to confirm.
6. Press the **Lower Upper** softkey to select the Lower or Upper trigger level.
 - Turn the Trigger Level Knob to adjust the position.
 - The lower trigger level cannot be higher than the upper trigger level.

Note:

In the trigger state message box, **L1** means the upper trigger lever while **L2** means the lower trigger level

7. Press the **Limit Range** softkey.
8. Turn the Universal Knob to select the desired slope condition, and push the knob to confirm.
 - **<= (less than a time value)**: Trigger when the positive or negative slope time of the input signal is lower than the specified time value.
 - **>= (greater than a time value)**: Trigger when the positive or negative slope time of the input signal is greater than the specified time value.
 - **[- . . -] (within a range of time value)**: Trigger when the positive or negative slope time of the input signal is greater than the specified lower limit of time and lower than the specified upper limit of time value.
 - **- -][- (outside a range of time value)**: Trigger when the positive or negative slope time of the input signal is greater than the specified upper limit of time and lower than the specified lower limit of time value.

6.7.3

The **Pulse Trigger** type triggers on the positive or negative pulse with a specified width.

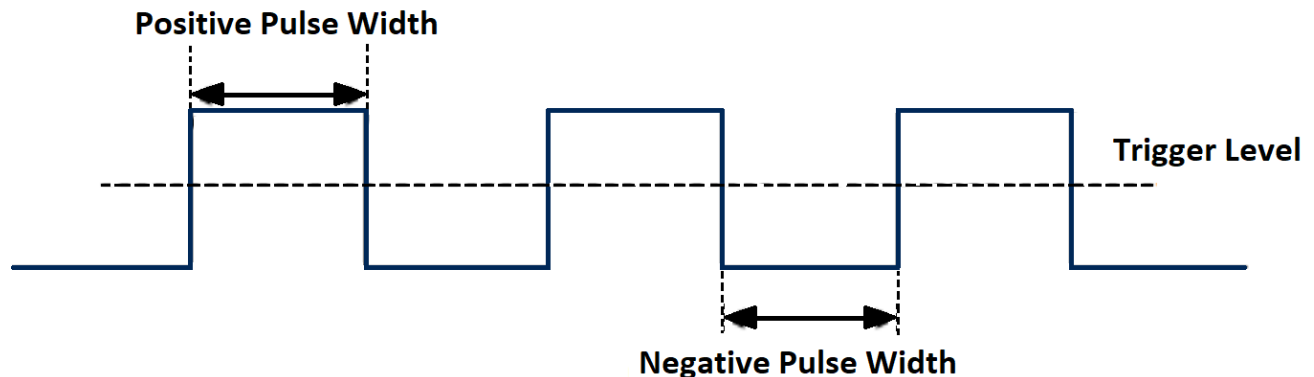

Figure 6.11 Pulse Trigger

1. Press the Setup key to enter the **Trigger Menu**.
2. Press the **Type** softkey to view the available trigger types.
3. Turn the Universal Knob
4. Select **Pulse** and push the Universal Knob to select the trigger source.
5. Turn the Trigger Level Knob to adjust the trigger level to the desired place.
6. Press the **Polarity** softkey to toggle between **Positive** and **Negative** pulse.
7. Press the **Limit Range** softkey and turn the Universal Knob to select the desired condition.
 - **<= (less than a time value)**: Trigger when the positive or negative pulse time of the input signal is lower than the specified time value. For example, for a positive pulse, if you set t (pulse real width) 100ns, the waveform will trigger.



Figure 6.12 Less than a Time Value

- **>= (greater than a time value)**: Trigger when the positive or negative pulse time of the input signal is greater than the specified time value. For example, for a positive pulse, if you set t (pulse real width) 100ns, the waveform will trigger.



Figure 6.13 Greater than a Time Value

- **[- - -] (within a range of time value)**: Trigger when the positive or negative pulse time of the input signal is greater than the specified lower limit of time and lower than the specified upper limit of time value.

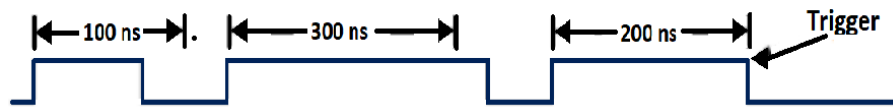

Figure 6.14 Within a Range of Time Value

- **--]]-- (outside a range of time value):** Trigger when the positive or negative pulse time of the input signal is greater than the specified upper limit of time and lower than the specified lower limit of time value.

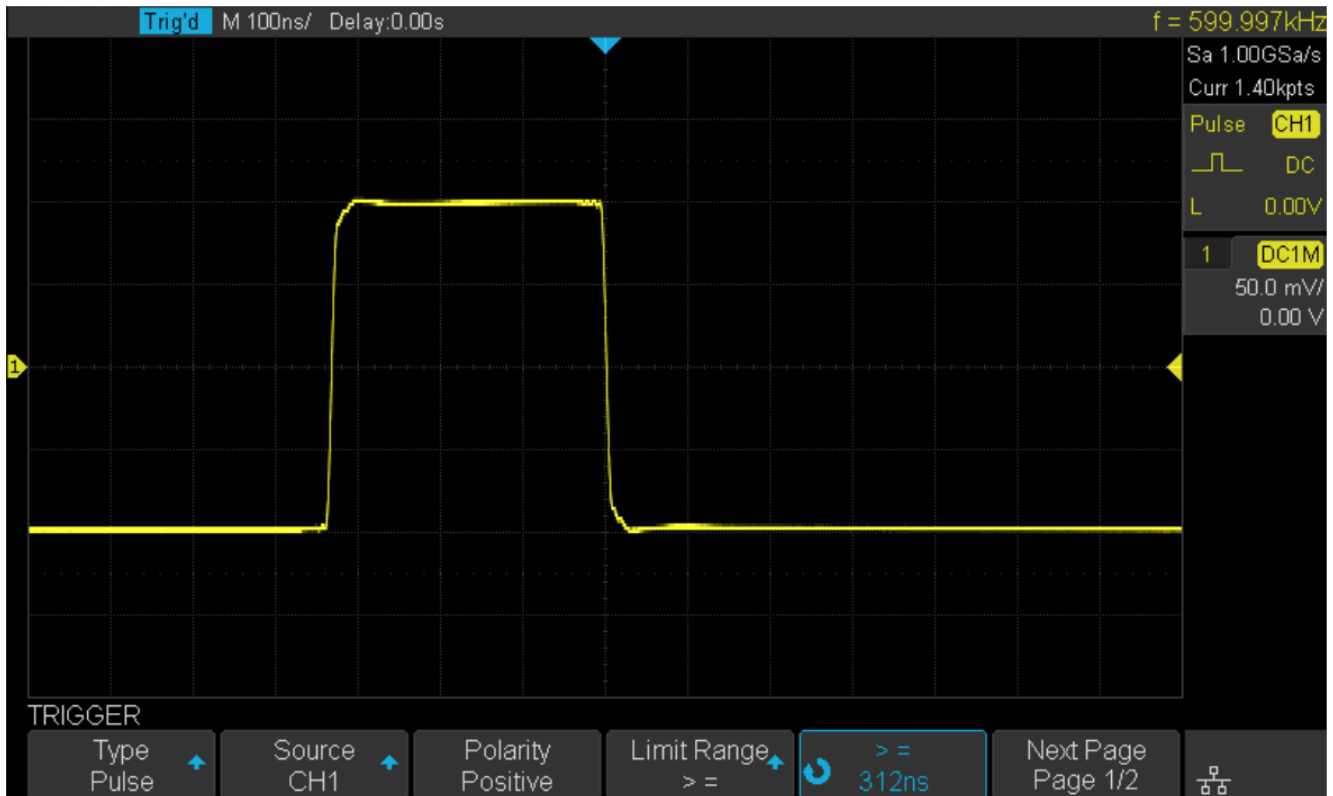

Figure 6.15 Pulse Trigger Example

Coupling and noise reject can be set in pulse trigger, see the sections [Trigger Coupling](#) and [Noise Rejection](#) for details.

6.7.4 Video Trigger

Video triggering can be used to capture the complicated waveforms of most standard analog video signals. The trigger circuitry detects the vertical and horizontal interval of the waveform and produces triggers based on the video trigger settings you have selected.

The oscilloscope supports standard video signal field or line of NTSC (National Television Standards Committee), PAL (Phase Alternating Line) HDTV (High Definition Television) and custom video signal trigger.

To setup **Video Triggering**:

1. Press the Setup key to enter the **Trigger Menu**.
2. Press the **Type** softkey to view the available trigger types.
3. Turn the Universal Knob
4. Select **Pulse** and push the Universal Knob to select the trigger source.

Note:

The trigger level is automatically set to sync pulse. Turning the Trigger Level Knob does not change the trigger level.

5. Press the **Standard** softkey to select the desired video standard. (**6.1.**)

Standard	Type	Sync Pulse
NTSC	Interlaced	BI-level
PAL	Interlaced	BI-level
HDTV 720P/50	Progressive	Tri-level
HDTV 720P/60	Progressive	Tri-level
HDTV 1080P/50	Progressive	Tri-level
HDTV 1080P/60	Progressive	Tri-level
HDTV 1080iP/50	Progressive	Tri-level
HDTV 1080i/50	Progressive	Tri-level
Custom		

Table 6.1 Video Standards

The parameters of **Custom Video Trigger** are shown in table **6.2**.

Frame Rate	25 Hz, 30 Hz, 50 Hz, 60 Hz	
Of Lines	300 to 2000	
PAL	1, 2, 3, 4	
HDTV 720P/50	1:1, 2:1, 4:1, 8:1	
Trigger Position	Line	Field
	(line value)/1	1
	(line value)/2	2
	(line value)/3	3
	(line value)/4	4
	(line value)/5	5
	(line value)/6	6
	(line value)/7	7
	(line value)/8	8

Table 6.2 Custom Video Trigger Parameters

Table 6.3 explains the relation between **Of Lines**, **Of Fields**, **Interlace**, **Trigger Line** and **Trigger Field** using an **Of Lines** value of 800.

Of Lines	Of Fields	Interlace	Trigger Line	Trigger Field
800	1	1:1	800	1
800	1, 2, 4 or 8	2:1	400	1, 12, 14, 18
800	1, 2, 4 or 8	4:1	200	1, 12, 14, 18
800	1, 2, 4 or 8	8:1	100	1, 12, 14, 18

Table 6.3 Parameters Relations

6. Press the **Sync** softkey to select **Any** or **Select** trigger mode.
 - **Any**: Trigger on any of the horizontal sync pulses.
 - **Select**: Trigger on the appointed line and field you have set.
 - Press the **Line** or **Field** softkey.
 - Turn the Universal Knob to set the value.

Table 6.4 list the line numbers per field for each video standard.

Standard	Field 1	Filed 2
NTSC	1 to 262	1 to 263
PAL	1 to 312	1 to 313
HDTV 720P/50, HDTV 720P/60	1 to 750	
HDTV 1080P/50, HDTV 1080P/60	1 to 1125	
HDTV 1080iP/50, HDTV 1080i/60	1 to 562	1 to 563

Table 6.4 Line Numbers Per Field

Triggering on a Specific Line of Video

Video triggering requires greater than 1/2 division of sync amplitude with any analog channel as the trigger source.

The example below is set to trigger on field 2, line 124 using the NTSC video standard.

1. Press the Setup key to enter the **Trigger** menu.
2. Press the **Type** softkey, then use the Universal Knob to select **Video**.
3. Press the **Source** softkey, then use the Universal Knob to select **CH 1** as the trigger source.
4. Press the **Standard** softkey, then use the Universal Knob to select **NTSC** as the trigger source.
5. Press the **Sync** softkey and set the option to **Select**; press the Line softkey and then turn the universal to set 22.
6. Press the **Line** softkey, then use the Universal Knob to select **022** as the trigger source.
7. Press the **Field** softkey, then use the Universal Knob to select **1** as the trigger source.

Use a Custom Video Trigger

Custom video triggering supports frame rate of 25Hz, 30Hz, 50Hz and 60Hz, and the line range is available from 300 to 2000. The steps below show how to set custom trigger.

1. Press the Setup key to enter the **Trigger** menu.
2. Press the **Type** softkey, then use the Universal Knob to select **Video**.
3. Press the **Source** softkey, then use the Universal Knob to select **CH 1** as the trigger source.
4. Press the **Standard** softkey, then use the Universal Knob to select **Custom** as the trigger source.

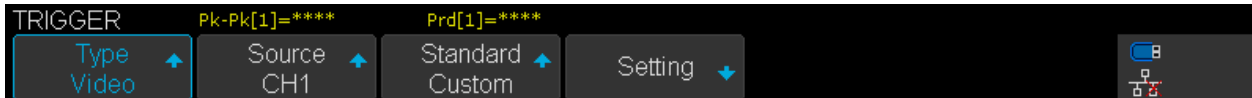

5. Press the **Setting** softkey to enter the custom setting function menu.
6. Press the **Interlace** softkey, then use the Universal Knob to set the desired value.
7. Press the **Of Field** softkey, then use the Universal Knob to set the desired value.

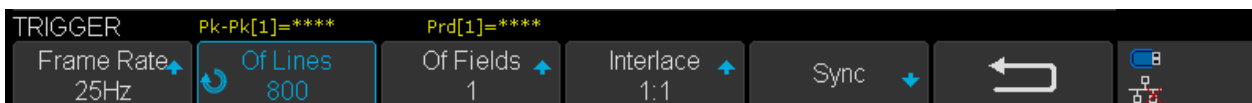

8. Press the **Sync** softkey to enter the **TRIG ON** menu.
9. Press the **Type** softkey to select **Any** or **Select**.
 - If **Select** was chosen:
 - Press the **Line** softkey, then use the Universal Knob to set the desired value.
 - Press the **Field** softkey, then use the Universal Knob to set the desired value.



6.7.5 Window Trigger

Windows trigger provides a high trigger level and a low trigger level. The instrument triggers when the input signal passes through the high trigger level or the low trigger level.

There are two kinds of window types: Absolute and Relative. They have different trigger level adjustment methods.

Under Absolute window type, the lower and the upper trigger levels can be adjusted respectively via the Level knob.

Under Relative window type the Center value is adjusted to set the window center, and the Delta value is adjusted to set the window range. The lower and the upper trigger levels always move together.

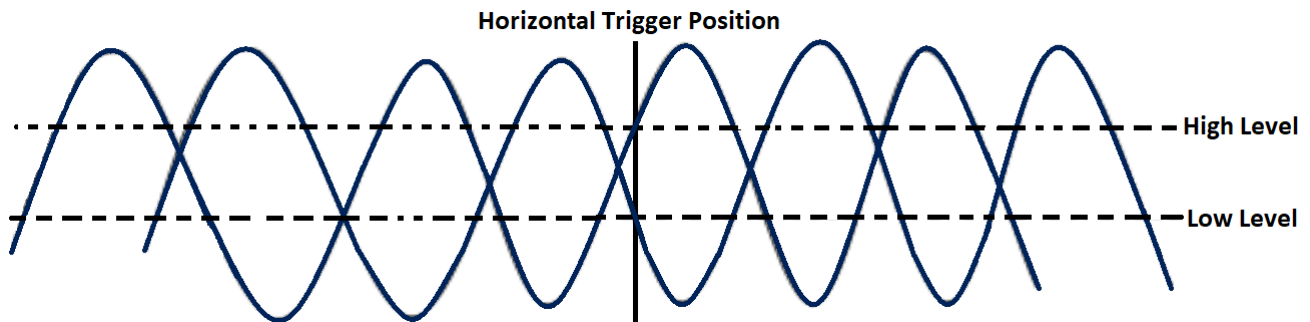

Figure 6.16 Window Trigger

- If the lower and the upper trigger levels are both within the waveform amplitude range, the oscilloscope will trigger on both rising and falling edge.
- If the upper trigger level is within the waveform amplitude range while the lower trigger level is out of the waveform amplitude range, the oscilloscope will trigger on rising edge only.
- If the lower trigger level is within the waveform amplitude range while the upper trigger level is out of the waveform amplitude range, the oscilloscope will trigger on falling edge only.

Set Window Trigger Via Absolute Window Type

1. Press the Setup key to enter the **Trigger** menu.
2. Press the **Type** softkey, then use the Universal Knob to select **Window**.
3. Press the **Source** softkey, then use the Universal Knob to select CH1 or CH2 as the trigger source.
4. Press the **Window Type** softkey to select **Absolute**.
5. Press the **Lower Upper** softkey to select Lower or Upper trigger level; then turn the Trigger Level Knob to adjust the position.

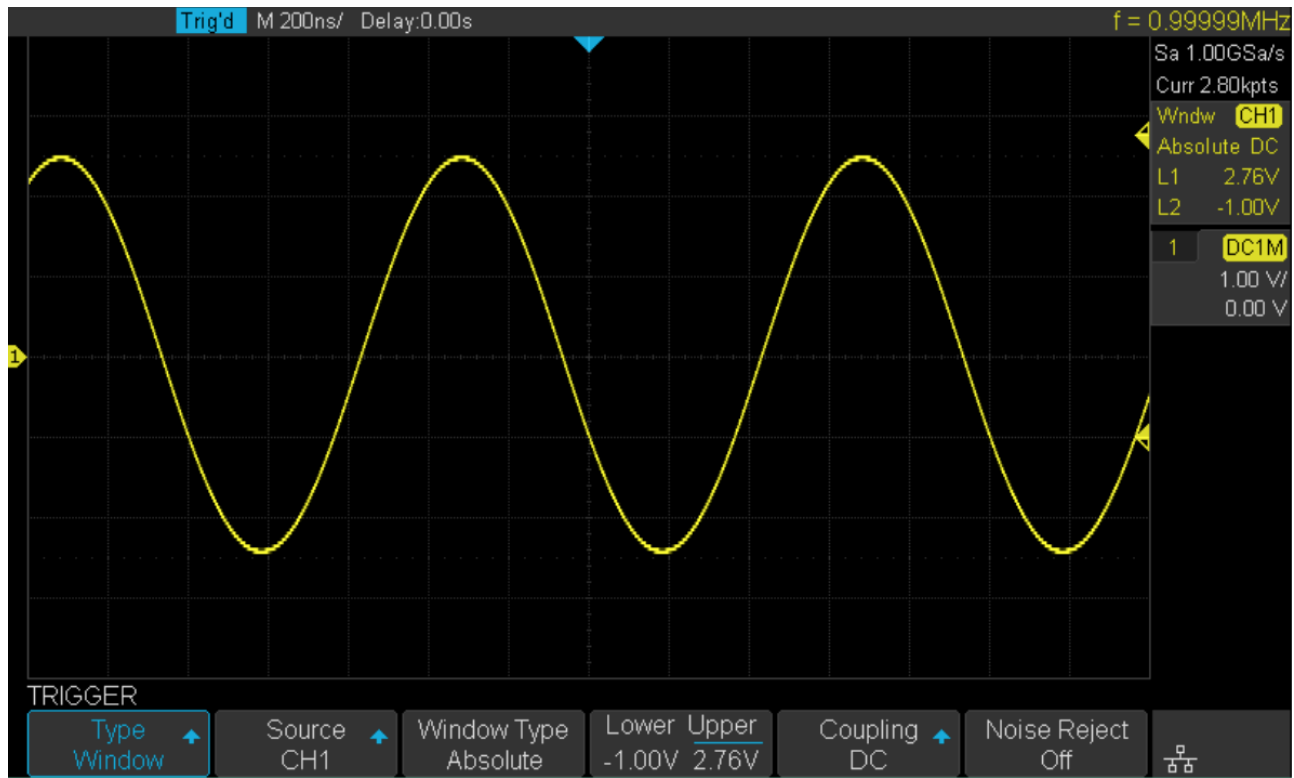

Figure 6.17 Absolute Window Trigger

Note:

The Lower trigger level cannot be higher than the upper trigger level. In the trigger state message box, L1 means the upper trigger level while L2 means the lower trigger level.

Set Window Trigger Via Relative Window Type

1. Press the Setup key to enter the **Trigger** menu.
2. Press the **Type** softkey, then use the Universal Knob to select **Window**.
3. Press the **Source** softkey, then use the Universal Knob to select CH1 or CH2 as the trigger source.
4. Press the **Window Type** softkey to select **Relative**.
5. Press the **Center Delta** softkey to select **Center** or **Delta** trigger level mode, then use the Universal Knob to adjust the position.

Note:

In the trigger state message box, C means Center, the center value of the lower and upper trigger levels; D means Delta, the difference between the lower (or upper) trigger level and the trigger level center.

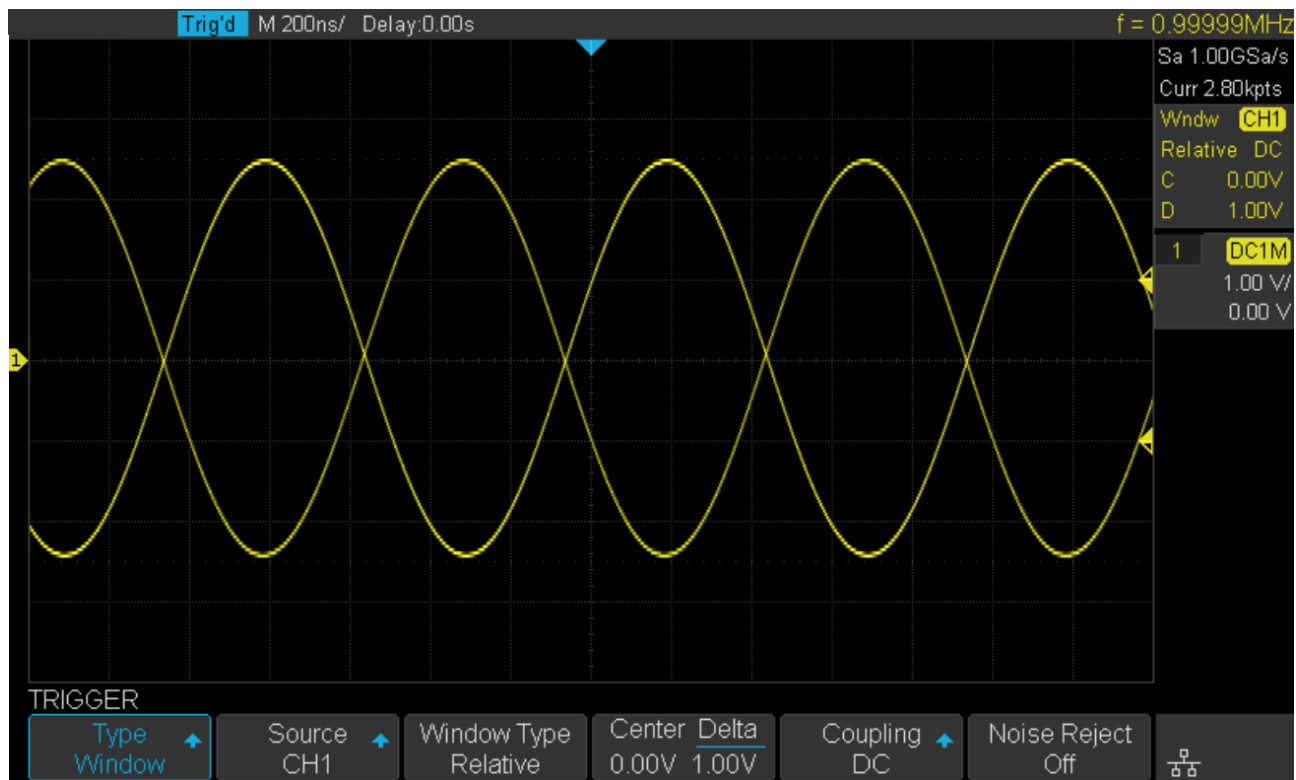

Figure 6.18 Relative Window Trigger

Note:

Coupling and noise reject can be set in Window trigger, see the sections **Trigger Coupling** and **Noise Rejection** for details.

6.7.6 Interval Trigger

Trigger when the times difference between the neighboring rising or falling edges meets the time limit ($< =$, $> =$, $[- - . - -]$, $- -] [- -$).

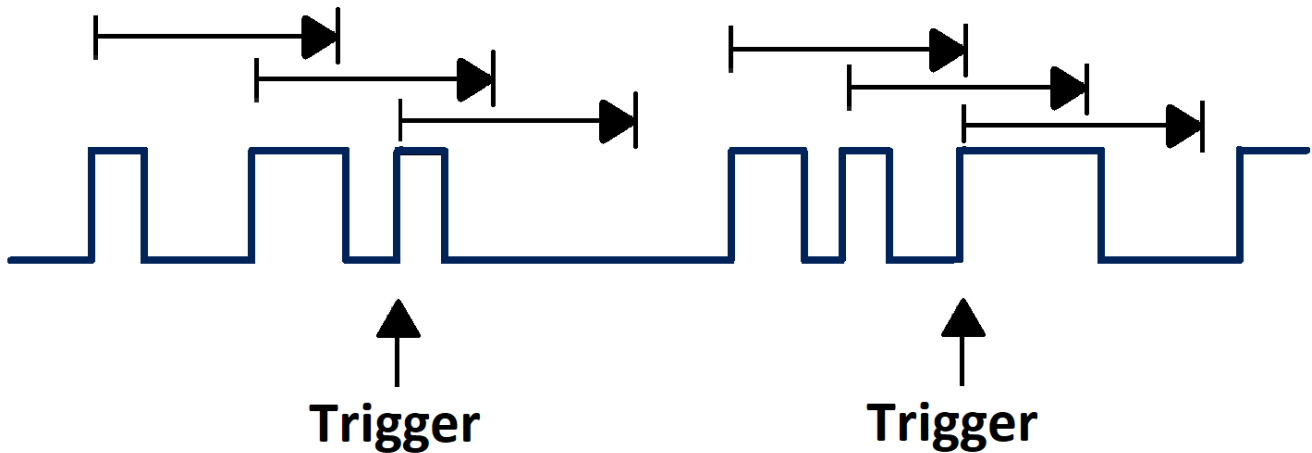

Figure 6.19 Interval Trigger

To set an interval trigger:

1. Press the Setup key to enter the **Trigger** menu.
2. Press the **Type** softkey, then use the Universal Knob to select **Interval**.
3. Press the **Source** softkey, then use the Universal Knob to select CH1 or CH2 as the trigger source
4. Press the **Slope** softkey to select rising or falling edge.
5. Press the **Limit Range** softkey, then use the Universal Knob to set the desired condition.
 - $< =$ (**less than a time value**): Triggers when the positive or negative pulse time of the input signal is lower than the specified time value.
 - $> =$ (**greater than a time value**): Triggers when the positive or negative pulse time of the input signal is greater than the specified time value.
 - $[- - . - -]$ (**within a range of time value**): Triggers when the positive or negative pulse time of the input signal is greater than the specified lower limit of time and lower than the specified upper limit of time value.
 - $- -] [- -$ (**outside a range of time value**): Triggers when the positive or negative pulse time of the input signal is greater than the specified upper limit of time and lower than the specified lower limit of time value.
6. Press the **Time Setting** softkey ($< =$, $> =$, $[- - . - -]$, $- -] [- -$), turn the Universal Knob to select the desired value.

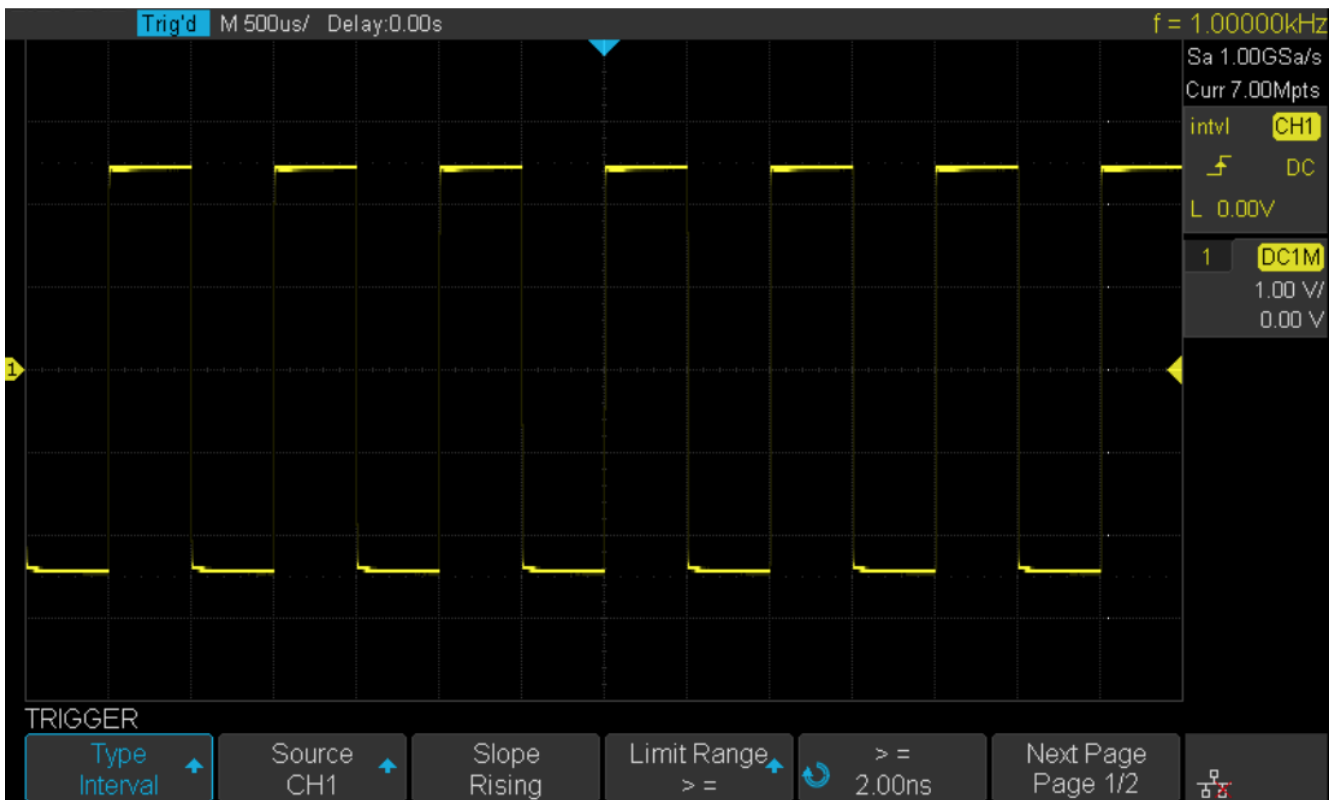

Figure 6.20 Interval Trigger Example

Note:

Coupling and noise reject can be set in interval trigger, see the sections **Trigger Coupling** and **Noise Rejection** for details.

6.7.7 Dropout Trigger

Dropout trigger includes two types: edge and state.

Edge

Triggers when an edge followed by a specified time with no edges is detected. This is useful for triggering on the end of a pulse train.

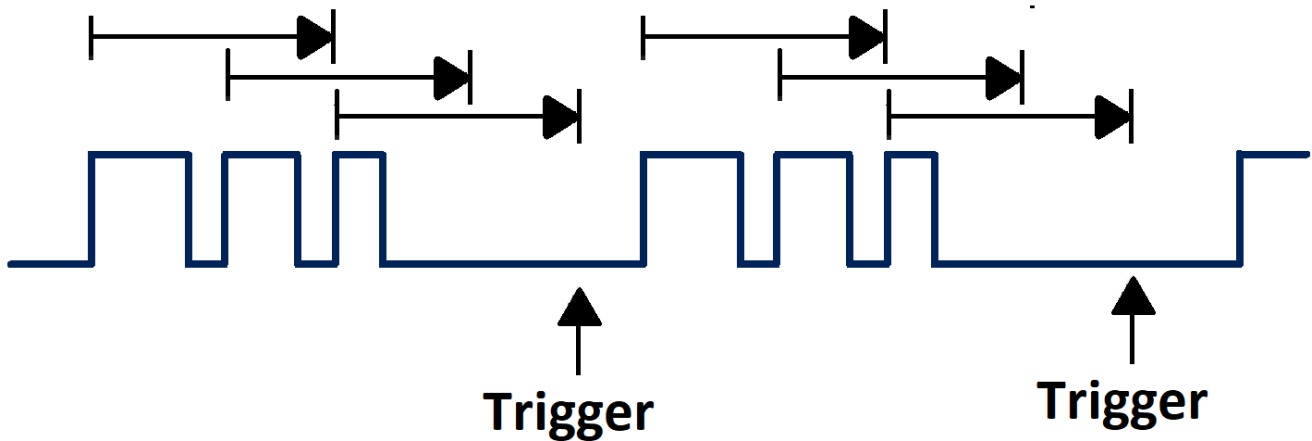

Figure 6.21 Dropout Trigger Edge

To set an edge dropout trigger:

1. Press the Setup key to enter the **Trigger** menu.
2. Press the **Type** softkey, then use the Universal Knob to select **Dropout**.
3. Press the **Source** softkey, then use the Universal Knob to select CH1 or CH2 as the trigger source.
4. Press the **Slope** softkey to select rising or falling edge.
5. Press the **OverTime Type** softkey to select **Edge**.
6. Press the **Time softkey**, then use the Universal Knob to set the desired value.

Note:

Coupling and noise reject can be set in interval trigger, see the sections **Trigger Coupling** and **Noise Rejection** for details.

State

Triggers when the signal enters or leaves a voltage level and stays there for a specified time. This is useful for detecting when a signal gets stuck at a particular level.

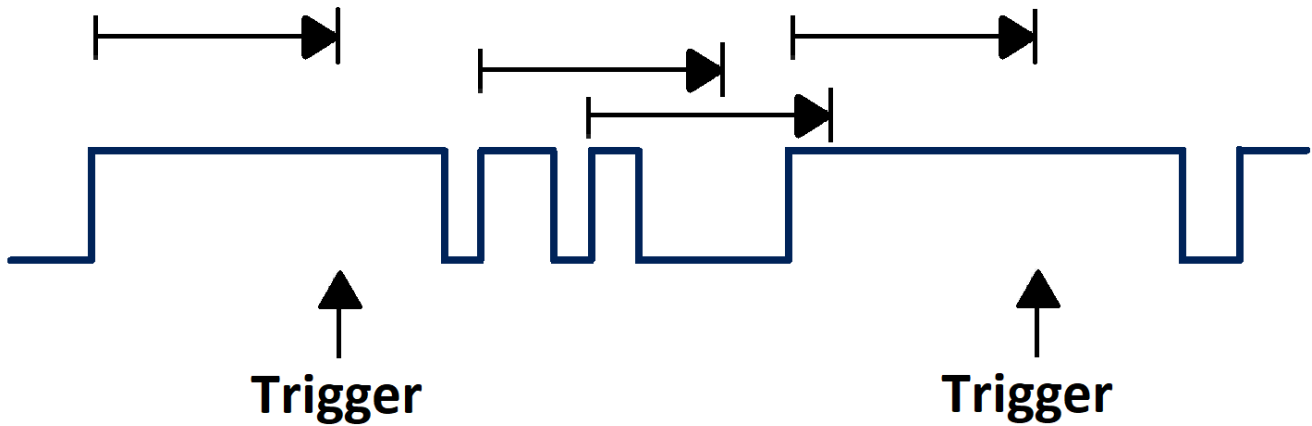

Figure 6.22 Dropout Trigger State

To set a state dropout trigger:

1. Press the Setup key to enter the **Trigger** menu.
2. Press the **Type** softkey, then use the Universal Knob to select **Dropout**.
3. Press the **Source** softkey, then use the Universal Knob to select CH1 or CH2 as the trigger source
4. Press the **Slope** softkey to select rising or falling edge.
5. Press the **OverTime Type** softkey to select **State**.
6. Press the **Time softkey**, then use the Universal Knob to set the desired value.

Note:

Coupling and noise reject can be set in interval trigger, see the sections **Trigger Coupling** and **Noise Rejection** for details.

6.7.8 Runt Trigger

The runt trigger detects a pulse that crosses the first threshold but not the second. It can occur when a logic driver has insufficient slew rate to reach a valid logic level in the time available.

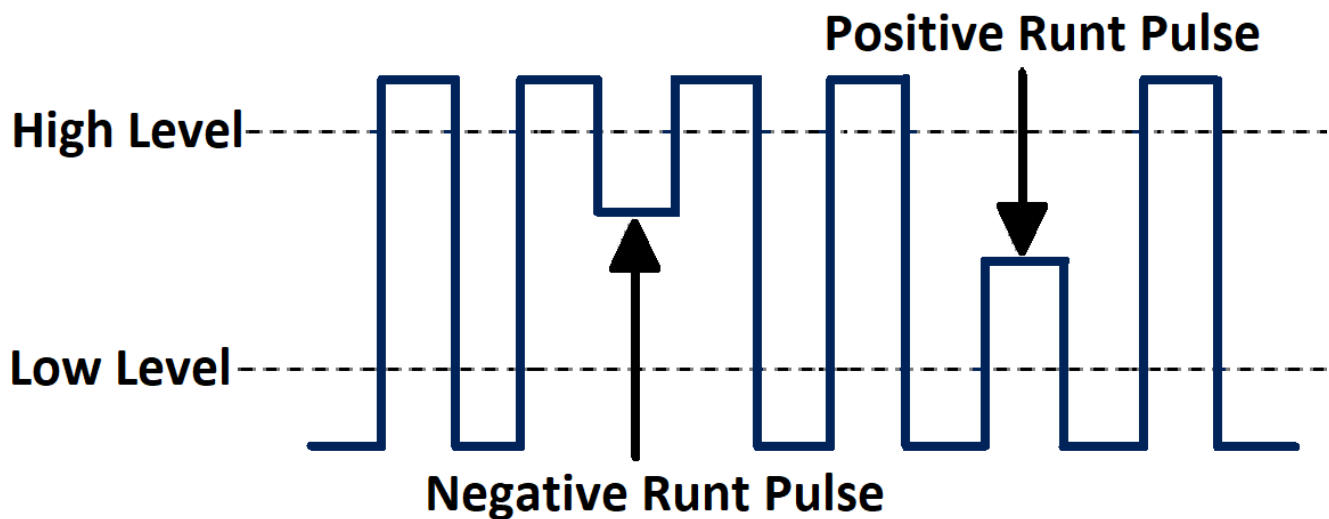

Figure 6.23 Runt Trigger

- A positive runt pulse crosses through a lower threshold but not an upper threshold.
- A negative runt pulse crosses through an upper threshold but not a lower threshold.

To setup a runt trigger:

1. Press the Setup key to enter the **Trigger** menu.
2. Press the **Type** softkey, then use the Universal Knob to select **Runt**.
3. Press the **Source** softkey, then use the Universal Knob to select CH1 or CH2 as the trigger source.
4. Press the **Polarity** softkey to select **Positive** or **Negative** pulse to trigger.
5. Press the **Slope** softkey to select rising or falling edge.
6. Press the **OverTime Type** softkey to select **State**.
7. Press the **Limit Range** softkey, then use the Universal Knob to select the desired condition (< =, > =, [- - . - -] or - -] [- -).
8. Press the **Time Setting** softkey, then use the Universal Knob to select the desired value.
9. Press the **Next Page** softkey to enter the second page of the **Trigger** menu.
10. Press the **Lower Upper** softkey to select **Lower** or **Upper** trigger level.
 - Use the Universal Knob to select the desired value.

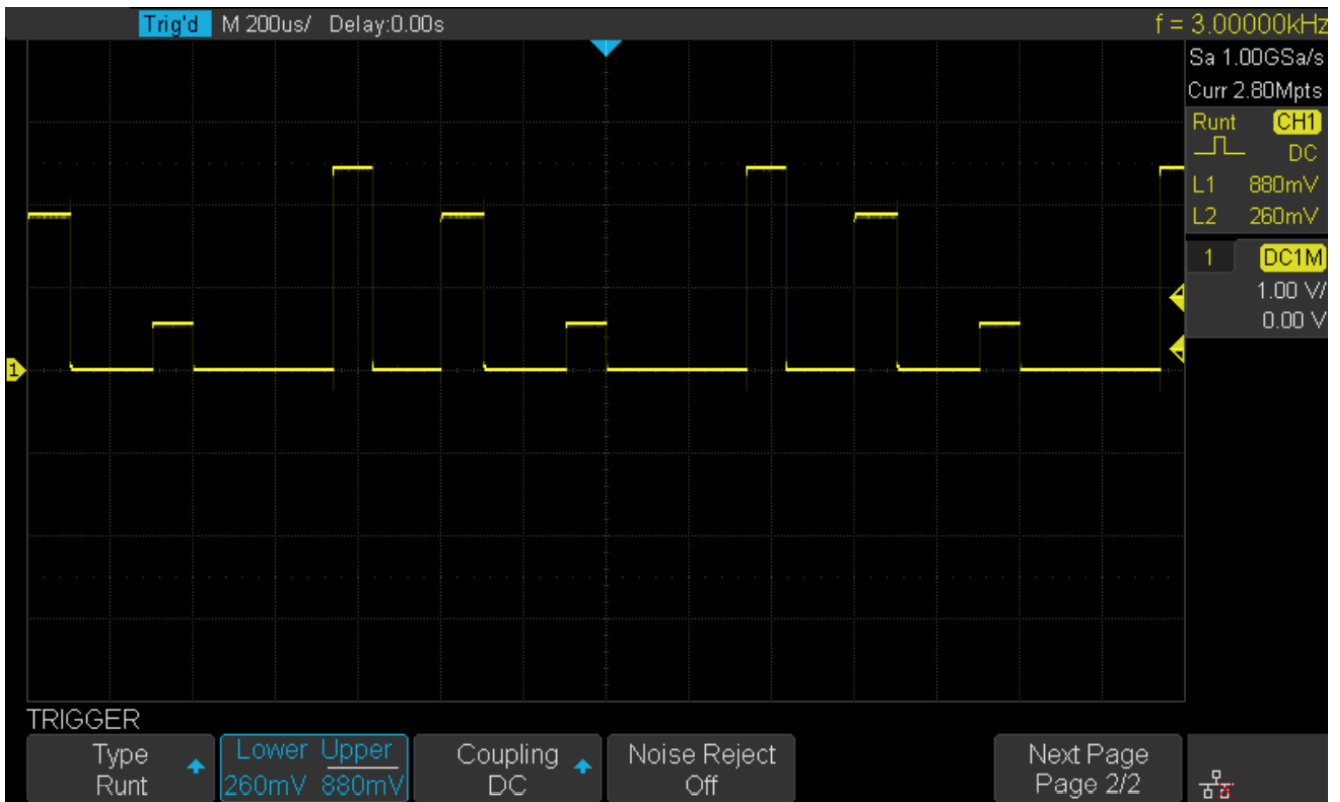

Figure 6.24 Runt Trigger Example

Note:

Coupling and noise reject can be set in interval trigger, see the sections **Trigger Coupling** and **Noise Rejection** for details.

6.7.9 Pattern Trigger

The Pattern trigger identifies a trigger condition by looking for a specified pattern. The pattern trigger can be expanded to incorporate delays.

Pattern durations are evaluated using a timer. The timer starts on the last edge that makes the pattern “true”. Potential triggers occur on the first edge that makes the pattern false, provided that the time qualifier criterion has been met.

The oscilloscope provides 4 patterns: logical AND, OR, NAND and NOR combination of the channels. Each channel can set to low, high or invalid.

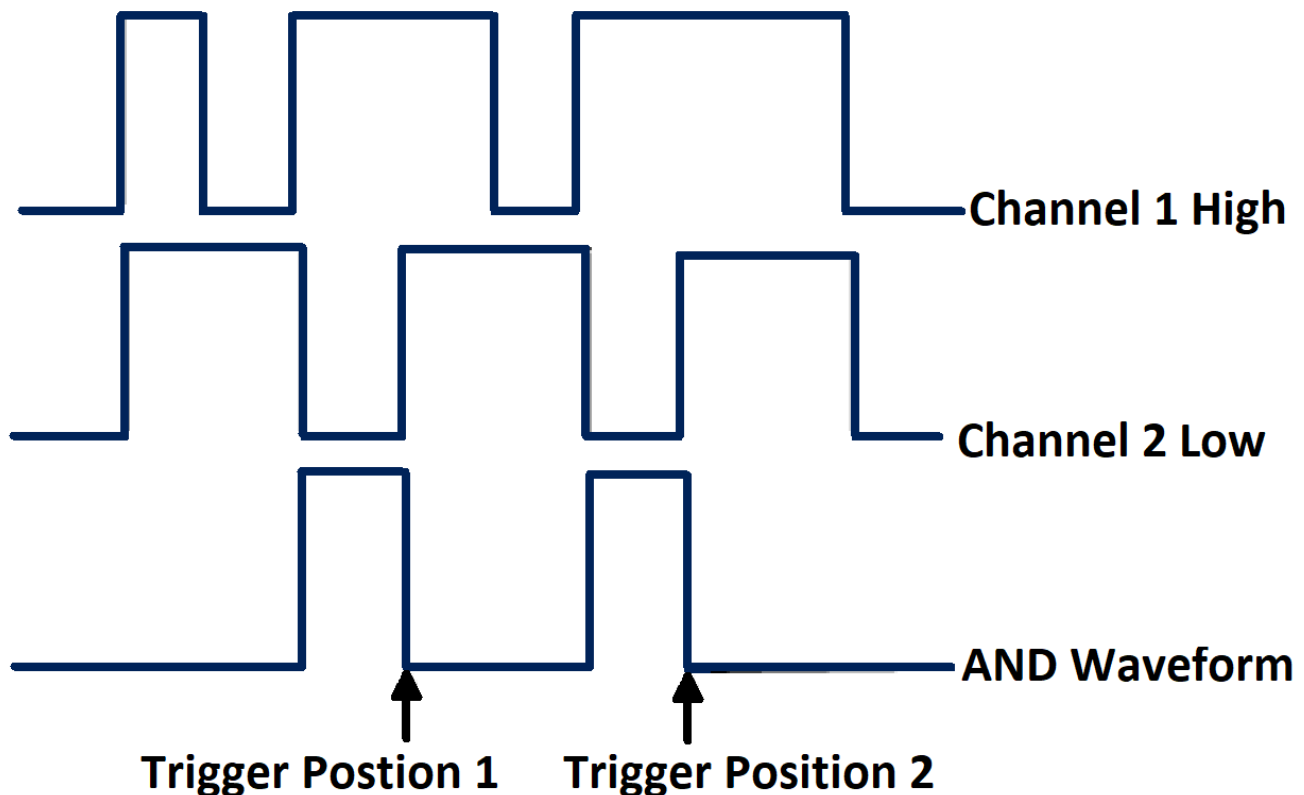

Figure 6.25 Pattern Trigger

To setup a pattern trigger:

1. Press the Setup key to enter the **Trigger** menu.
2. Press the **Type** softkey, then use the Universal Knob to select **Pattern**.
3. Press the **Source** softkey, then use the Universal Knob to select CH1 or CH2 as the trigger source.
4. Press the **Don't care** softkey to assign **Don't care**, **High** or **Low** to the channel.
 - **Low**: Sets the pattern to low on the selected channel. A low is a voltage level that is less than the channel's trigger level or threshold level.
 - **High** sets the pattern to high on the selected channel. A high is a voltage level that is greater than the channel's trigger level or threshold level.
 - **Don't care** sets the pattern to don't care on the selected channel. Any channel set to don't care is ignored and is not used as part of the pattern.
 - If all channels in the pattern are set to **Don't care**, the oscilloscope will not trigger.

Note:

Adjust the trigger level for the selected analog channel by turning the Trigger Level knob while high or low are selected. Invalid doesn't need to set trigger level.

5. Press the **Next Page** softkey to enter the second page of the pattern trigger menu.
6. Press the **Logic** softkey and then turn the Universal Knob to select the desired logic combination **AND, OR, NAND** or **NOR**.
7. Press the **Time** softkey, then use the Universal Knob to select the desired time value.
8. Press the **Holdoff Close** softkey to enable/disable the Holdoff function
 - Use the Universal Knob to set the desired value.

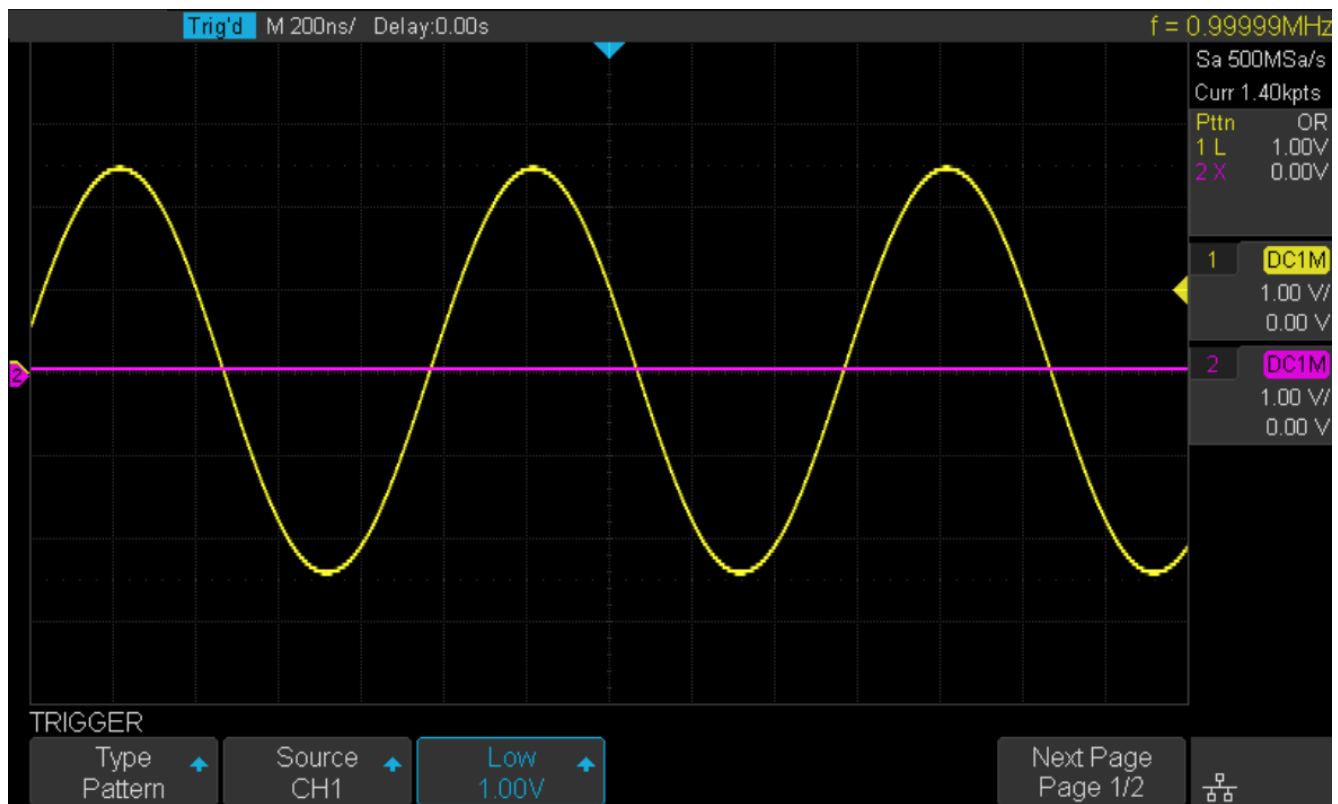

Figure 6.26 Pattern Trigger Example

Note:

Holdoff can be set in pattern trigger, see the sections [Trigger Holdoff](#) for details.

Serial Trigger and Decode

The oscilloscope provides I2C, SPI, UART, CAN and LIN serial trigger and decode. This chapter introduces the method of triggering and decoding these serial signals in details.

7.1 I2C Trigger and Serial Decode

7.1.1 Setup for I2C Signals

To set the I2C (Inter-IC bus) signal first, connect the serial data signal (SDA) and serial clock signal (SCK) to oscilloscope, then specify the threshold voltage of each input signal.

1. Touch **Decode** key to enter the **Decode** menu.
2. Touch **Decode** and select the desired slot (**Decode1** or **Decode2**).
3. Touch **Protocol** and then select **I2C** by turning the Universal Knob.
4. Touch **Signal** to enter the **Signal** menu.
5. Set the **SCL** (I2C's clock signal):
 - Touch **SCL** to select the channel that is connected to the I2C clock signal.
 - Touch first **Threshold** softkey, then use the Universal Knob to set the I2C clock signal's threshold voltage level .
 - The threshold voltage level is for decoding, and it will be regarded as the trigger voltage level when the trigger type is set to serial.
6. Set **SDA** (I2C's data signal):
 - Touch **SDA** to select the channel that is connected to the I2C data signal.
 - Touch second **Threshold** softkey, then use the Universal Knob to set the I2C clock signal's threshold voltage level .
 - The threshold voltage level is for decoding, and it will be regarded as the trigger voltage level when the trigger type is set to serial.

Note:

SDA should keep stable during the whole high clock cycle, otherwise it will be interpreted as a start or stop condition (data transitioning while the clock is high)

-
7. Touch  to return previous menu.

7.1.2 I2C Trigger

The I2C trigger has nine trigger conditions: (**Start, Stop, Restart, No Ack, EEPROM, 7 Addr&Data, 10 Addr&Data and Data Length**)

- **Start Condition:** The oscilloscope will be triggered when the SDA signal transitions from high to low while the SCL clock is high. If it is chosen as the condition of trigger (including frame triggers), a restart will be treated as a “Start condition”.
- **Stop Condition:** The oscilloscope will be triggered when SDA transitions from low to high while the SCL is high.

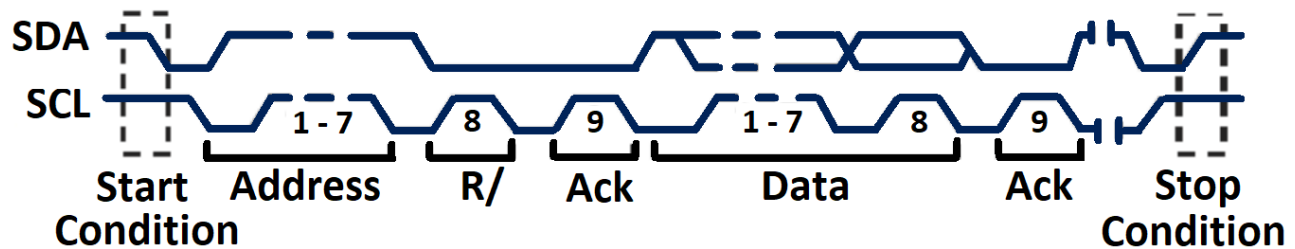

Figure 7.1 Start and Stop Conditions

- **Restart:** The oscilloscope will be triggered when another “Start condition” occurs before a “Stop condition”.
- **No Ack:** The oscilloscope will be triggered when SDA data is high during any SCL’s ACK bit.
- **EEPROM:** The trigger searches for EEPROM control byte (the value is 1010xxx) on the SDA bus where there is a Read bit and an ACK bit behind EEPROM.
 - Use the **Limit Range** to set the qualifier.
 - Use the **Data1** to set the data’s value.

Note:

If EEPROM’s data is greater than Data1, the oscilloscope will be triggered at the edge of ACK bit behind Data byte. It’s unnecessary that the Data byte must follow the EEPROM.

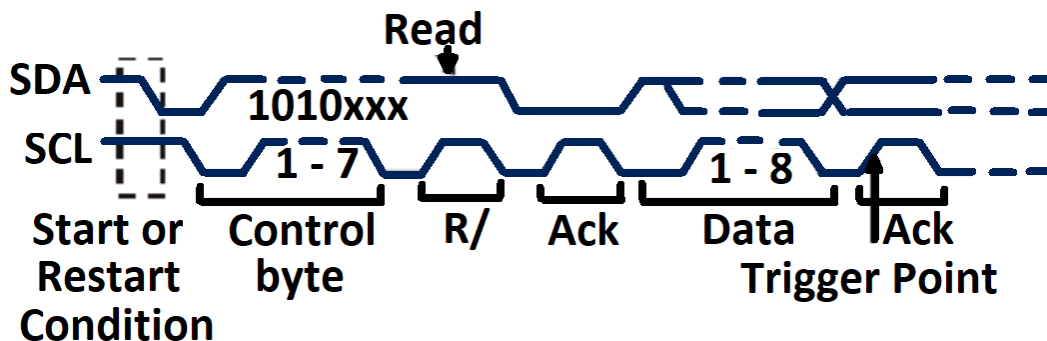

Figure 7.2 Trigger Point

- **7 address & Data:** The oscilloscope will be triggered when the following conditions are satisfied:
 - The address’s length must be 7 bits and the address’s value must be the same as the set value.
 - Data1’s or Data2’s value is set to the same value of the signal’s data.
 - Both Data1’s and Data2’s value are set and the signal has two consecutive data values, the first is value is Data1 and the second data value is Data2.

Note:

If the data's value is 0xXX, any data value will be matched.

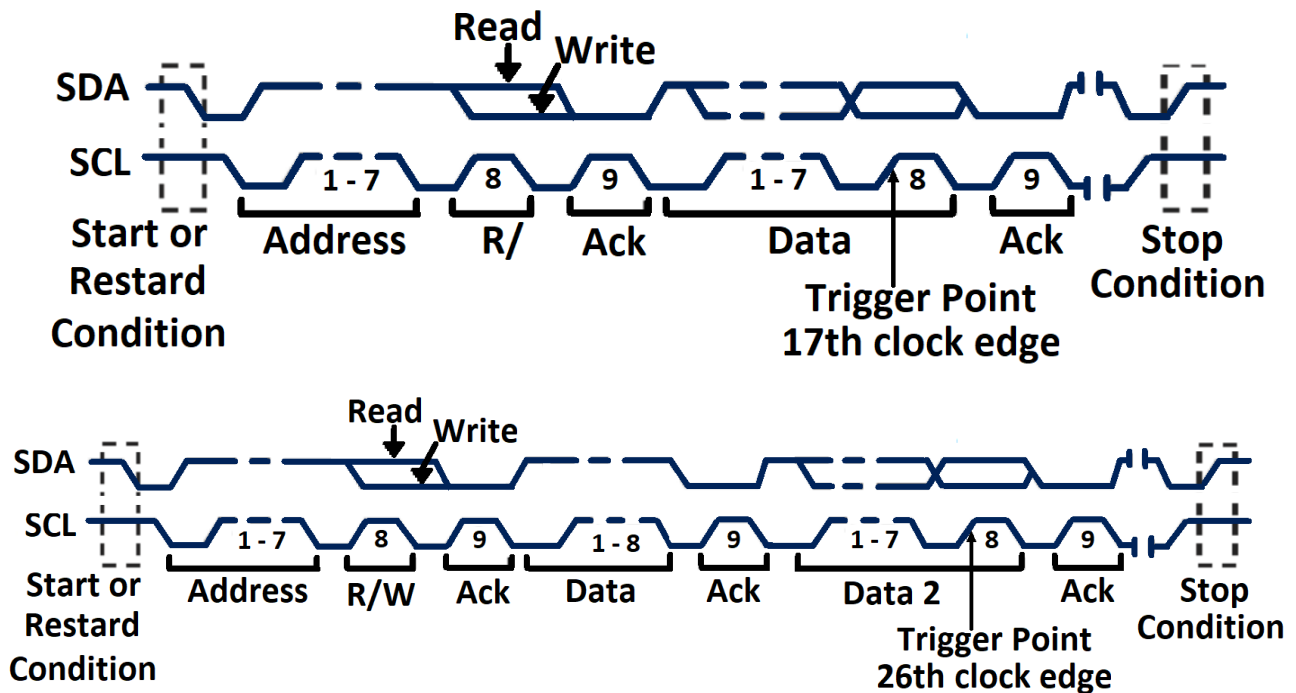

Figure 7.3 7 Address & Data

- **10 address & Data:** The oscilloscope will be triggered when the following conditions are satisfied:
 - The address's length must be 10 bits and the address's value must be the same as the set value.
 - Data1's or Data2's value is set to the same value of the signal's data.
 - Both Data1's and Data2's value are set and the signal has two consecutive data values, the first is value is Data1 and the second data value is Data2.

Note:

If the data's value is 0xXX, any data value will be matched.

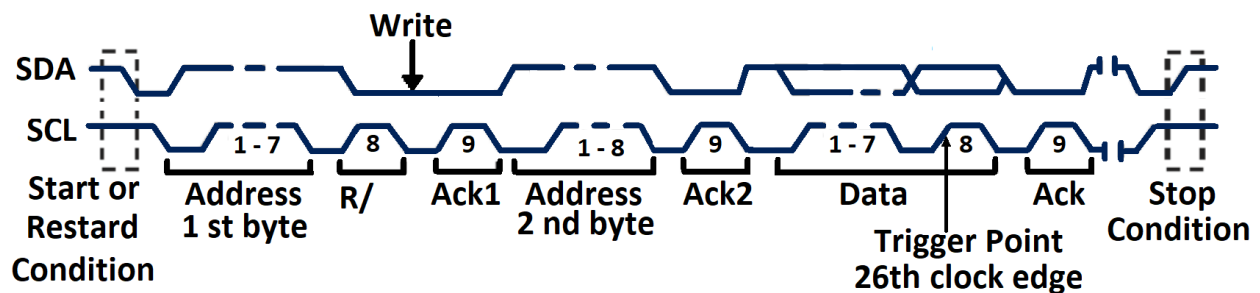

Figure 7.4 10 Address & Data

- **Data Length:** When SDA data's length is equal to the value of Byte Length and address's length is the same as set value, the oscilloscope will be triggered. Byte length is in the range of 1 to 12 bits.

Operation Step

1. Touch Setup key to enter the **Trigger** menu.
2. Touch **Type** and select **Serial**.
3. Touch **Protocol** and select **I2C**.
4. Touch **Trigger Setting** softkey.
5. Touch **Condition** and turn the Universal Knob to select the trigger condition:

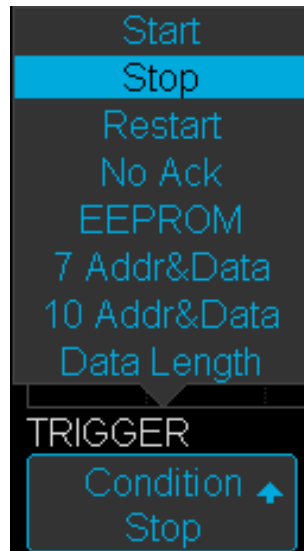

Figure 7.5 Condition Options

- If EEPROM is selected :
 - Touch **Limit Range** to set the qualifier (=, < or >).
 - Touch **Data1** and set its value by turning the Universal Knob/
- If 7 Addr & Data or 10 Addr & Data is selected:
 - Touch **Addr** and turn the Universal Knob to select the 7- bit or 10- bit device address.
 - Touch **Data1** or **Data2** and set the value.
 - Touch **R/W bit** and select write-frame or read-frame to trigger the oscilloscope.

Note:

If the device's address is 7-bit, the value of address is in range of 0x00 to 0x7F. If device's address is 10-bit, the value of address is in range of 0x00 to 0x3FF.

- If **Data Length** is selected:
 - Touch **Address** to set the SDA address length 7bit or 10 bit.
 - Touch **Byte Length** and set the byte length by Universal Knob. The range of the Byte Length is 1 to 12.

7.1.3 I2C Serial Decode

Once the setup for I2C signal and trigger has been completed, the decoding operation must be setup.

1. Touch Decode followed by the **Decode** softkey.
 - Select one of the options from the Decode1 and Decode2.
2. Touch **Display** and select **On** to display the result of decoding.
3. Touch **Next Page** to view page 2/2 of the **Decode** menu.
4. Touch **Format** to change the character encoding format of the decoding's result.
5. Touch **List** to enter the **List** menu.
6. Touch **Display** and choose the Decode option selected in step 2.
7. Touch **Lines** and set the number of lines by Universal Knob.
 - The range of the lines is 1 to 7.
8. Press the  to return to the previous menu.
9. Touch **Scroll** and turn the Universal Knob to view all frames.

Interpreting I2C Decode

The frames of decoding result:

- The address value is displayed at the beginning of a frame. The write address is displayed in green, and the read address is displayed in yellow.
- W/R bit is represented by (W) and (R), following the address value.
- The data value is displayed in white.
- "~A" after a data or address bits indicates no acknowledgement. For example, DB~A.
- A red dot indicates there is not enough space on the display to show the complete content of a frame.

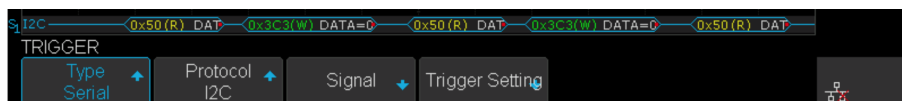

Figure 7.6 I2C Decode Bus Display

The lists of decoding result:

- **Time:** The horizontal displacement between current frame and trigger position.
- **Address:** The address of a frame.
- **R/W:** The type of a frame (write or read).
- **Data:** The value of data.

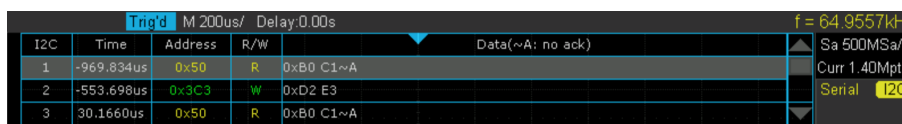

Figure 7.7 Decode List Display

7.2 SPI Trigger and Serial Decode

7.2.1 Setup for SPI Signals

Setting the SPI (Serial Peripheral Interface) signal includes two steps: Connecting the CLK, MISO, MISO and CS signal to oscilloscope, specifying the parameters of each input signal.

1. Touch Decode key to enter the **Decode** menu.
2. Touch **Decode** and select the desired slot (**Decode1** or **Decode2**).
3. Touch **Protocol** softkey, then use the Universal Knob to select SPI.
4. Touch **Signal** to enter the **Signal** menu.



Figure 7.8 Signal Menu

5. Set CLK (clock signal):
 - Touch **CLK** to enter CLK menu.
 - Touch **CLK** to select the channel that is connected to the SPI clock signal.
 - Touch **Threshold** to set the SPI clock signal's threshold voltage level by Universal Knob.
 - The threshold voltage level is for decoding, and it will be regard as the trigger voltage level when set the trigger type to serial.
 - Touch **Edge Select** to set the oscilloscope will samples at clock signal's rising edge or falling edge.
 - Touch  to return previous menu.



Figure 7.9 CLK Menu



6. Set MISO:
 - Touch **MISO** to enter the **MISO** menu.
 - Touch **MISO** to select the channel that is connected to the SPI MISO signal.
 - Touch **Threshold** softkey, then use the Universal Knob to set the SPI MISO signal's threshold voltage level.
 - The threshold voltage level is for decoding, and it will be regard as the trigger voltage level when set the trigger type to serial.
 - Touch  to return to the previous menu.



Figure 7.10 MISO Menu

7. Set MOSI:

- Press the **MOSI** to enter the MOSI menu.
- Touch **MOSI** to select the channel that is connected to the SPI MOSI signal.
- Press the **Threshold** softkey, then use the Universal Knob to set the SPI MOSI signal's threshold voltage level.
 - The threshold voltage level is for decoding, and it will be regarded as the trigger voltage level when the trigger type is set serial.
- Touch  to return to the previous menu.

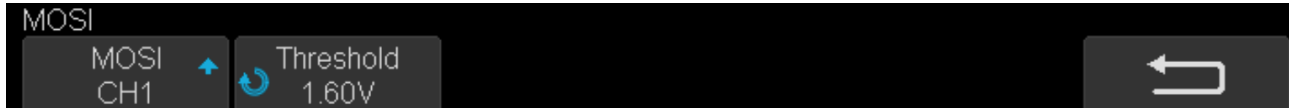



Figure 7.11 MOSI Menu

8. Set CS:

- Touch **CS** to enter the MOSI menu.
- Touch **CS Type** to select the chip select type.
- Modify the CD value.
- Touch  to return to the previous menu.

Function Menu	Settings	Description
CS Type	~CS	Low voltage level of CS signal is available
	CS	High voltage level of CS signal is available
	CLK Timeout	If the time between two edges of the clock signal is less than (or equal to) the value of timeout, the signal between the two edges is treated as a frame. The range of clock timeout is 100 ns - 5 ms. This setting is suitable for case where the CS signal is not connected, or the number of oscilloscope channels is insufficient (such as 2-channel oscilloscopes).

Table 7.1 CS Type Parameters

Example

Connect the data, CLK and ~CS signals of a SPI bus respectively to C1, C2, and C3. Data width = 8-bit, Bit order = MSB, CS polarity = CS, and 12 data bytes are transmitted in one frame.

In the SPI trigger signal menu, set the source and threshold of CLK, MISO and CS signals, then copy the trigger settings to decoding. Adjust the time base, so that the falling edge of the CS signal is shown in the display:

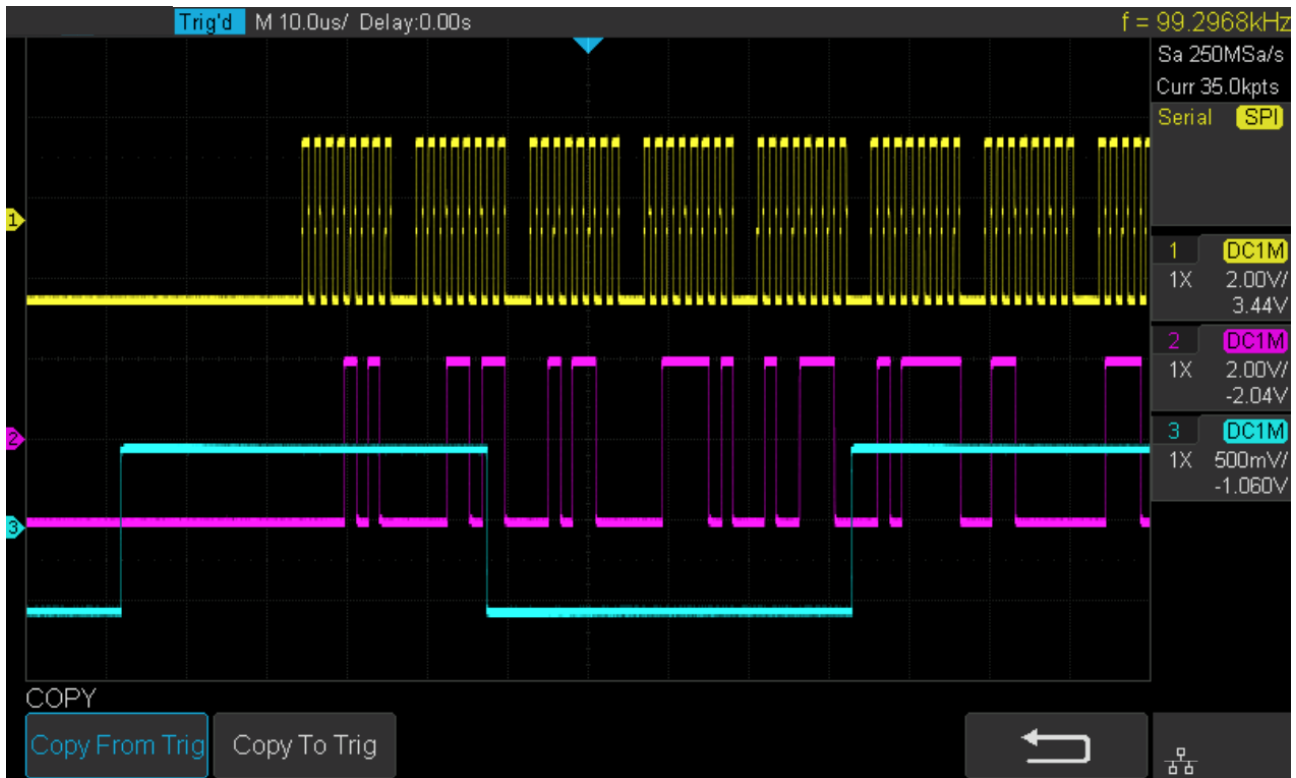

Figure 7.12 Example

When the CS type is set to Clock Timeout, the clock idle time between frames is T3, the clock period is T1, then set the timeout to a value between T1 and T3

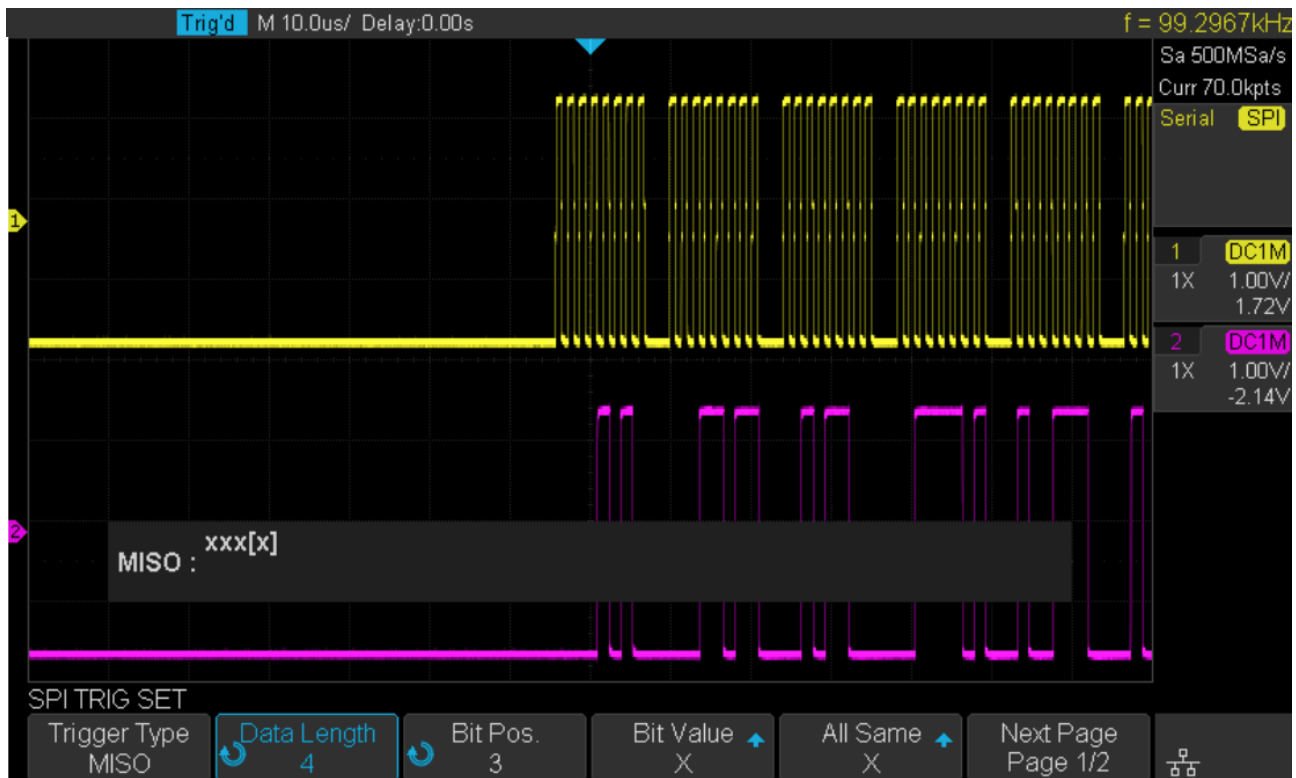

Figure 7.13 Example 2

If the data width is set to be greater than 8 bits (such as 16 bits), the clock idle time between 8-bit data packets T2, and then set the timeout time to a value between $T1/2+T2$ and $T3$.

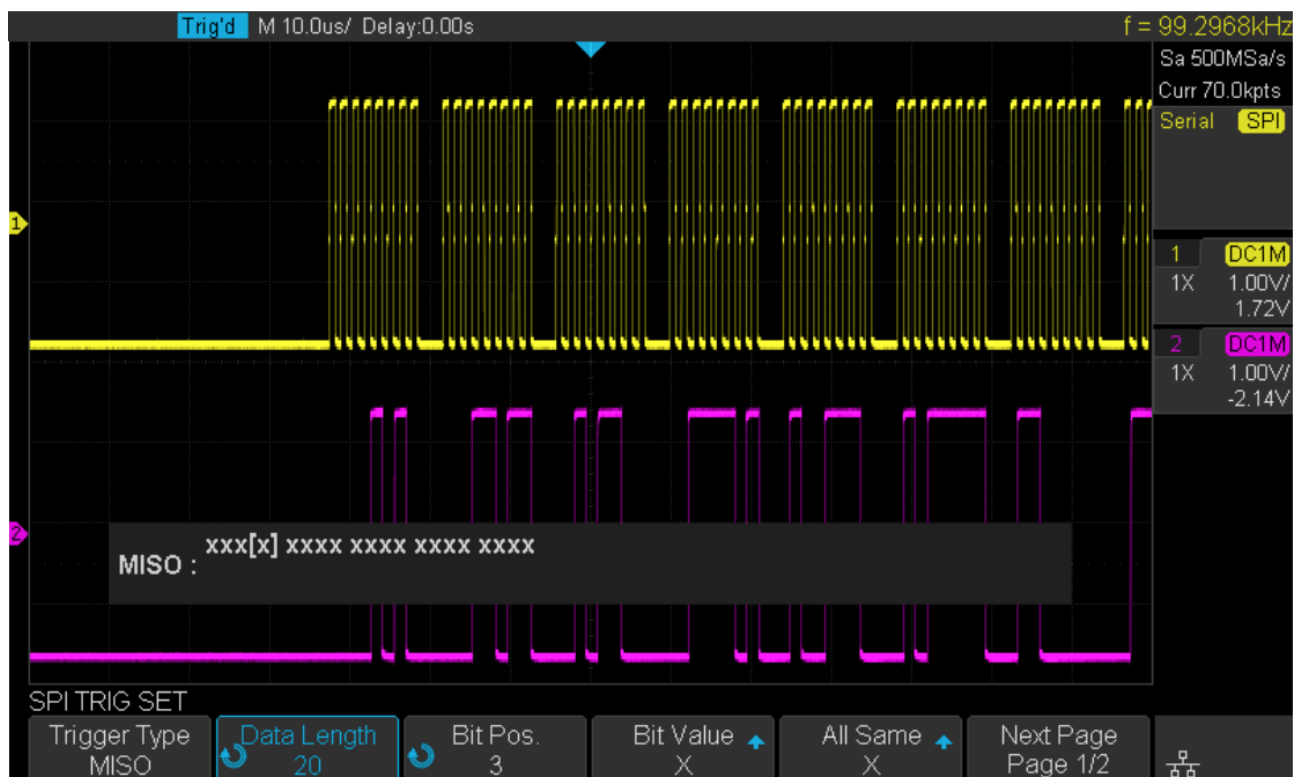

Figure 7.14 Example 3

7.2.2 SPI Trigger

This section provides a brief introduction for the operation of the SPI trigger.

1. Touch **Setup** button to enter the **TRIGGER** function menu.
2. Touch **Type** and select **Serial**.
3. Touch **Protocol** and select **SPI**.
4. Touch **Trigger Setting** softkey.



Figure 7.15 SPI Trigger Setup Menu

5. Touch **Trigger Type** to select the trigger condition.

Function Menu	Settings	Explanation
Trigger Type	MISO	Master-In, Slave-Out
	MOSI	Master-Out, Slave-In

Table 7.2 SPI Trigger Type

6. Touch Data Length softkey, and turn the Universal Knob to set the length of a data. The range of data length is 4 to 96 bits.
7. Set the value of the trigger data.
 - Set the value of a bit:
 - a. Touch **Bit Roll** to select a bit in data.
 - b. Touch **Bit Value** to set the value of the selected bit.
 - Set the value of all bits:
 - a. Touch **All Same** to set the value of all bits.

Function Menu	Settings	Explanation
Bit Value	0	High voltage level
	1	Low voltage level
	X	Don't care the voltage level

Table 7.3 SPI Bit Value

8. Touch **Next Page** softkey.
9. Touch **Bit Order** to set the bit order (MSB or LSB).

7.2.3 SPI Serial Decode

Once the setup of SPI signal and trigger is complete, the SPI signals can be decoded. Operation steps as follows:

1. Touch **Decode** → **Decode**. Select one of the options from the **Decode1** and **Decode2**.
2. Touch **Display** and select **On** to display the result of decoding.
3. Touch **List** to enter the **LIST** function menu.
4. Touch **Display** and choose the same options as the first step.
5. Touch Lines and set the number of lines by **Universal Knob**. The range of the lines is 1 to 7.
6. Touch **Format** to change the character encoding format of the decoder's result.
7. Touch **Scroll** and turn the **Universal Knob** to view all frames.

Interpreting SPI Decode

The frames of decoding result:

- The data values are displayed in frames and are shown in white. Support 4 96 bit data display.
- *MISO* — the decoding result of “Master-In, Slave-Out” line.
- *MOSI* — the decoding result of “Master-Out, Slave-In” line.
-  Indicates there is not enough space on the display to show the complete content of a frame, and some content is hidden.



Figure 7.16 SPI Decode Bus Display

The lists of decoding result:

- *Time* — the horizontal displacement between current frame and trigger position.
- *MISO* — the decoding result of “Master-In, Slave-Out” line.
- *MOSI* — the decoding result of “Master-Out, Slave-In” line.

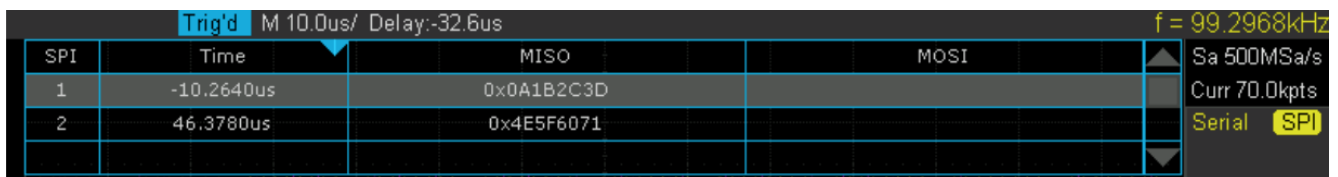



Figure 7.17 SPI Decode List Display

7.3 UART Trigger and Serial Decode

7.3.1 Setup for UART Signals

1. Touch **Decode** key to enter the **DECODE** function menu.
2. Touch **Decode** and select the desired slot (Decode1 or Decode2).
3. Touch **Protocol** and then select **UART** by turning **Universal Knob**.
4. Touch **Signal** to enter the **SIGNAL** menu as below shows.
5. Set RX:
 - a. Touch **RX** to select the channel that is connected to the RX signal.
 - b. Touch first **Threshold** key to set the RX signal's threshold voltage level by **Universal Knob**. The threshold voltage level is for decoding, and it will be regard as the trigger voltage level when set the trigger type to serial.
6. Set TX:
 - a. Touch TX to select the channel that is connected to the TX signal.
 - b. Touch second Threshold key to set the TX signal's threshold voltage level by Universal Knob. The threshold voltage level is for decoding, and it will be regard as the trigger voltage level when set the trigger type to serial.
7. Touch  to return previous menu.
8. Touch **Configure** to enter **BUS CONFIG** menu.

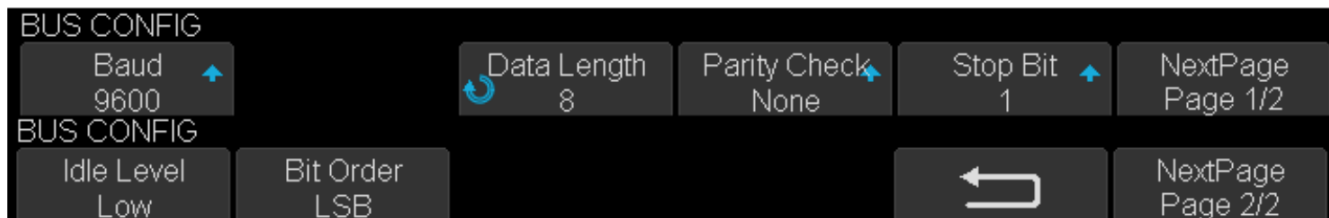

Figure 7.18 Bus Config Menu

9. Touch **Baud** to set baud rate.
 - The baud rate can be set as predefined value.
 - If the desired baud rate is not listed, press the **Baud** and select custom option, press the **Custom** and turn the **Universal Knob** to set the desired baud rate.
10. Touch **Data Length** and set byte bits (5-8) by **Universal Knob**.
11. Touch **Parity Check** to set the type of parity check (**Even**, **Odd**, **Mark**, **Space** or **None**).
12. Touch **Stop Bit** to set the length of stop bit (1, 1.5 or 2 bits).
13. Touch **Next Page** softkey.
14. Touch **Bit Order** to select the bit order (**LSB** or **MSB**).
15. Touch **Idle Level** to set the idle level (**LOW** or **HIGH**).

7.3.2 UART Trigger

This section includes an introduction and description for the operation of the UART trigger.

1. Touch **Setup** key to enter the **TRIGGER** function menu.
2. Touch **Type** and select **Serial**.
3. Touch **Protocol** and select **UART**.
4. Touch **Trigger Setting** to enter **UART TRIG SET** menu.



Figure 7.19 UART Trig Set Menu

5. Touch **Source Type** to select the source of trigger (RX or TX).
6. Touch **Condition** and set up the desired trigger condition:
 - **Start** — the oscilloscope will be triggered at the position of start bit.
 - **Stop** — the oscilloscope will be triggered at the position of stop bits.
 - **Data** — the oscilloscope will be triggered when found a byte which is equal to (greater or less than) the specified data.
 - a. Touch **Compare Type** and choose an equality qualifier (>, < or =).
 - b. Touch **Value** to set data's value. Data's value is in range of 0x00 to 0xff.
 - **ERROR** — if the parity check has been set, and the bit of parity check is error, the oscilloscope will be triggered.

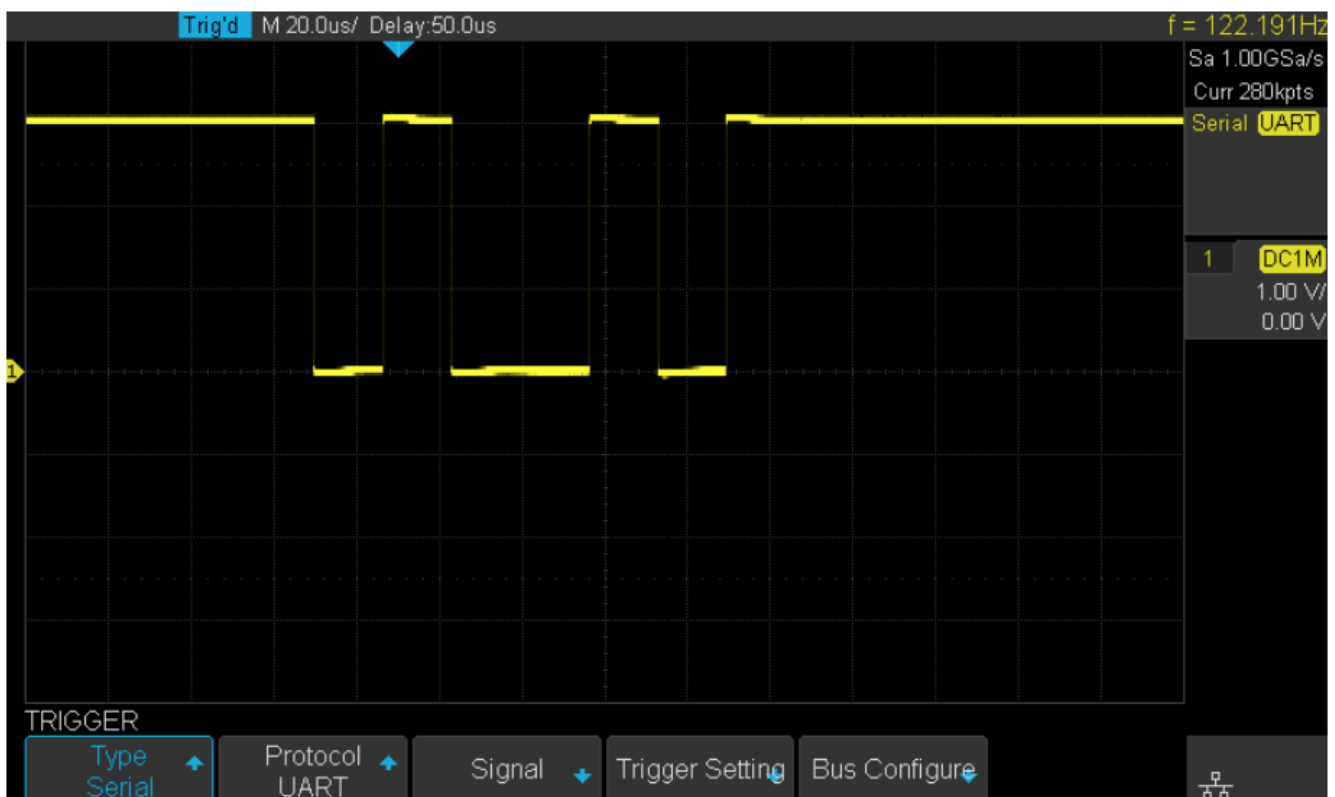

Figure 7.20 UART Trigger

7.3.3 UART Serial Decode

Upon completing the setup of UART signal and trigger, the UART signals can be decoded. Operation steps as follows:

1. Press **Decode** → **Decode**. Select one of the options from the **Decode1** and Decode2.
2. Touch **Display** and select **On** to display the result of decoding.
3. Touch **List** to enter the **LIST** function menu.
4. Touch **Display** key and choose the same options as the first step.
5. Touch **Lines** and set the number of lines by **Universal Knob**. The range of the lines is 1 to 7.
6. Touch **Format** softkey to change the character encoding format of the decoding's result.
7. Turn the **Universal Knob** to view all frames.

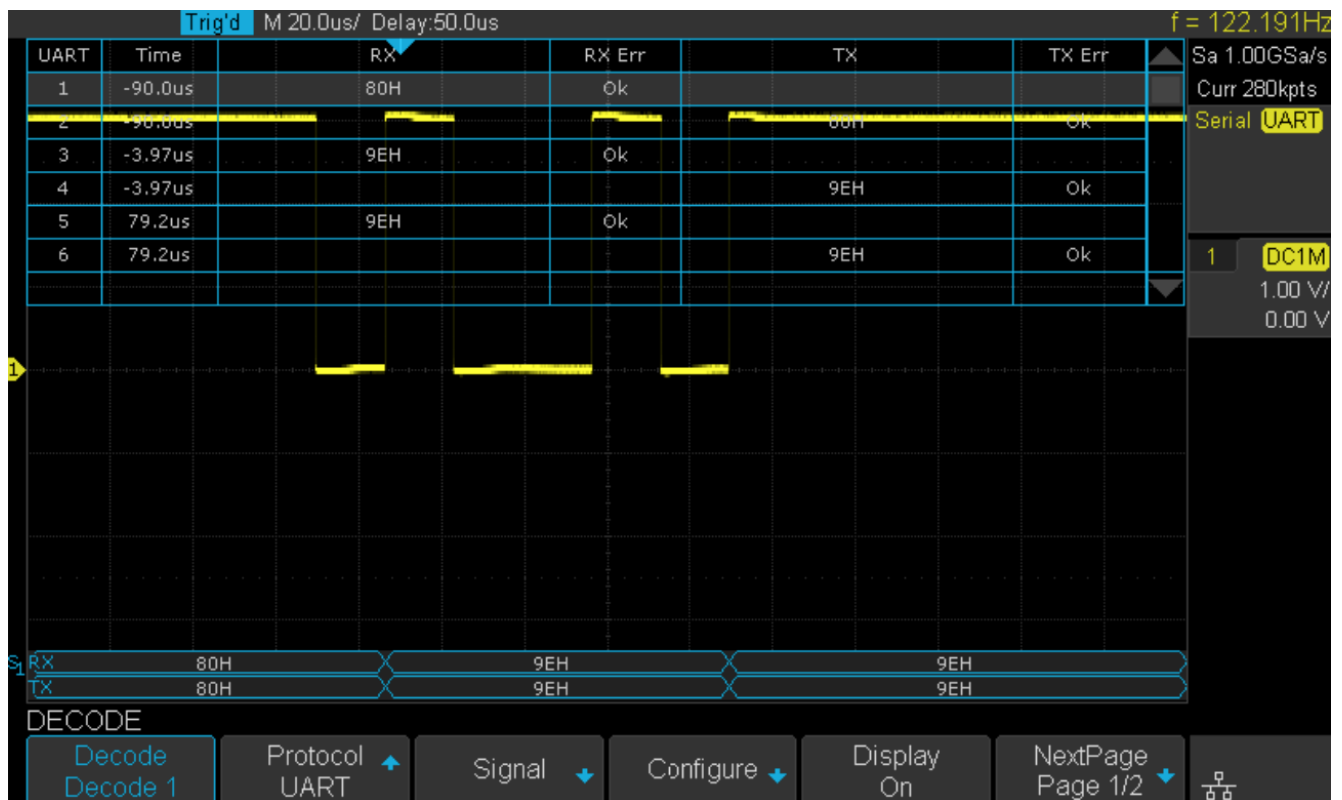



Figure 7.21 UART Decode

Interpreting UART Decode

The frames of decoding result:

- RX — the decoding result of the data received.
- TX — the decoding result of the data transmitted.
-  Indicates there is not enough space on the display to show the complete content of a frame, and some content is hidden.

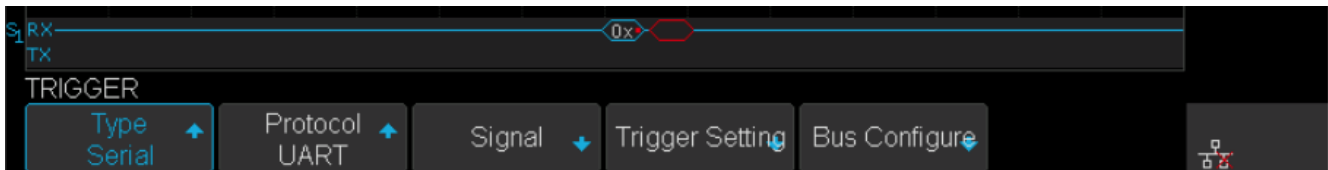

Figure 7.22 UART Decode Bus Display

The lists of decoding result:

- Time — the horizontal displacement between current frame and trigger position.
- RX — the receiving channel.
- TX — the transmitting channel.
- RX Err — Parity error or unknown error in the data received.
- TX Err — Parity error or unknown error in the data transmitted.

UART	Time	RX	RX Err	TX	TX Err
1	-90.0us	80H	Ok		
2	-90.0us	9EH	Ok		
3	-3.97us	9EH	Ok		
4	-3.97us	9EH	Ok		
5	79.2us	9EH	Ok		
6	79.2us	9EH	Ok		

Figure 7.23 UART Decode List Display

7.4 CAN Trigger and Serial Decode

Placed in order of **Setup for CAN Signals**, **CAN Trigger**, **CAN Serial Decode** to trigger and decode the signals.

7.4.1 Setup for CAN Signals

1. Touch **Decode** key to enter the **DECODE** function menu.
2. Touch **Decode** and select the desired slot (Decode1 or Decode2).
3. Touch **Protocol** and then select **CAN** by turning Universal Knob.
4. Touch **Signal** to enter the **SIGNAL** menu as shown in figure ??.



Figure 7.24 CAN Signal Menu

- a. Touch **Source** to select the channel that is connected to the CAN signal.
 - b. Touch **Threshold** key to set the CAN signal's threshold voltage level by **Universal Knob**. The threshold voltage level is for decoding, and it will be regard as the trigger voltage level when set the trigger type to serial.
5. Touch **Configure** to enter the **BUS CONFIG** menu.
 6. Touch **Baud** to set baud rate by rotating the **Universal Knob**.
 - The baud rate can be set as predefined value (from 5kb/s to 1Mb/s) or custom value (from 5kb/s to 1Mb/s).
 - If the desired baud rate is not listed, press **Baud** and select the **custom** option, press the **Custom** and turn the **Universal Knob** to set the desired baud rate.

7.4.2 CAN Trigger

This section provides a brief introduction and description for the operation of the CAN trigger.

Trigger Conditions

- Start — the oscilloscope will be triggered at the start bit of a frame.
- Remote — the oscilloscope will be triggered by a remote frame with specified ID.
- ID — the oscilloscope will be triggered by a remote or data frame that have specified ID.
- ID+DATA — the oscilloscope will be triggered by data frame that have specified ID and data.
- Error — the oscilloscope will be triggered by an error frame.

Operation Steps

1. Touch **Setup** to enter the **TRIGGER** function menu.
2. Touch **Type** and select **Serial**.
3. Touch **Protocol** and select **CAN**.
4. Touch **Trigger Setting** to enter the **CAN TRIG SET** menu.
5. Touch **Condition** and select the trigger condition by turning the **Universal Knob**:
 - If you select the **REMOTE** and **ID** condition:
 - a. Touch **ID Bits** to set the length of ID (11bits or 29 bits).
 - b. Touch **Curr ID Byte** and turn the **Universal Knob** to select the byte that you want to set.
 - c. Touch **ID** and set the ID's value by turning the **Universal Knob**. (Tips: In order to make is convenient for the operator to set the parameters, ID b is split into several bytes. For example, if the ID's length is 11 bits, it will be split into two bytes, a byte includes 8 bits. If "1st byte" is selected, only the 8 least significant bits can be changed.)
 - If you select the **ID+DATA** condition:
 - a. Touch **ID** bits to select the ID's length (11 or 29 bits).
 - b. Touch **Curr ID Byte** and turn the **Universal Knob** to select the byte that you want to modify.
 - c. Touch **ID** and set the ID's value by turning the **Universal Knob**.
 - d. Touch **Data** and set the value of the first byte by turning the **Universal Knob**.

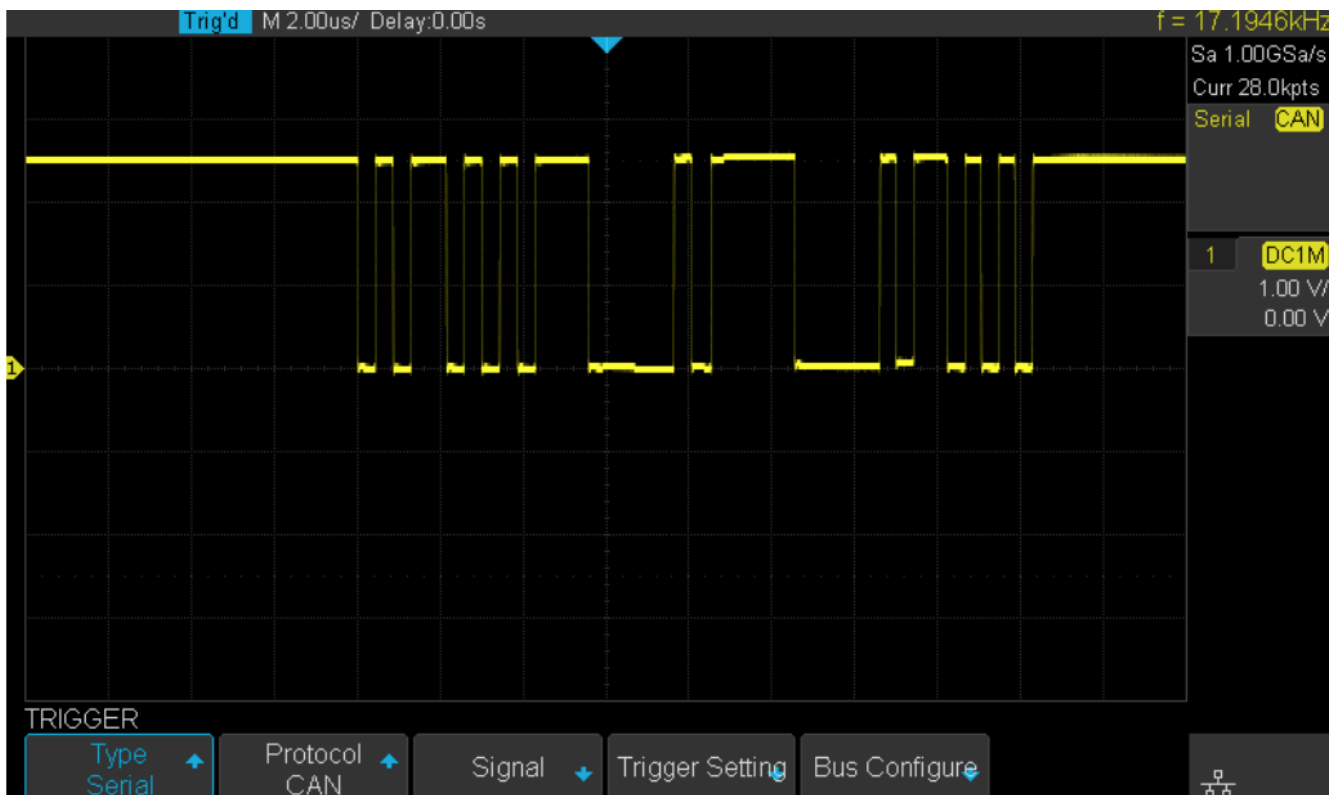

Figure 7.25 CAN Trigger

7.4.1 CAN Serial Decode

Upon completing the setup of can signal and trigger, the CAN signals can be decoded.

1. Press **Decode** → **Decode**. Select one of the options from the Decode1 and Decode2.
2. Touch **Display** and select **On** to display the result of decoding.
3. Touch **List** to enter the **LIST** function menu.
4. Touch **Display** and choose the same options as the first step.
5. Touch **Lines** and set the number of lines by **Universal Knob**. The range of the lines is 1 to 7.
6. Touch **Format** softkey to change the character encoding format of the decoder's result.
7. Touch **Scroll** and turn the **Universal Knob** to view all frames.

Interpreting CAN Decode

The frame of decoding result:

- Arbitration field is displayed in frame
- Control field is displayed in frame
- Data field is displayed in frame
- CRC field is displayed in frame
-  Indicates there is not enough space on the display to show complete content of a frame and some content is hidden.

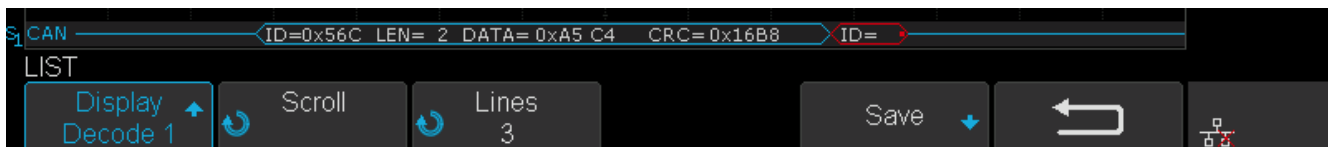

Figure 7.26 CAN Decode Bus Display

The list of decoding result:

- Time — the horizontal displacement between current frame and trigger position.
- Type — the type of frames, “D” represents data frame, “R” represents remote frame.
- ID — the id of frames, the oscilloscope can automatically detect the length of frame's id (11 bits or 27 bits).
- Length — the length of data field.
- Data — the value of data field.
- CRC — the value of CRC (Cyclic Redundancy Check) field.
- ACK — Acknowledgment bit.

CAN	Time	Type	ID	Length	Data	CRC	ACK
1	-18.9655ms	D	0x56C	2	0xA5 C4	0x16B8	yes
2	-18.2711ms						no
3	-4.55200us	D	0x56C	2	0xA5 C4	0x16B8	yes

Figure 7.27 CAN Decode List Display

7.5 LIN Trigger and Serial Decode

7.5.1 Setup for LIN Signals

There are two steps of setting the LIN signal, connecting the signal to oscilloscope, specifying the parameters of each input signal.

1. Touch **Decode** button to enter the **DECODE** function menu.
2. Touch **Decode** and select the desired slot (Decode1 or Decode2).
3. Touch **Protocol** and then select **LIN** by turning Universal Knob.
4. Touch **Signal** to enter the **SIGNAL** menu as shown in figure 7.22.



Figure 7.28 CAN Signal Menu

5. Touch **Source** to select the channel that is connected to the LIN signal.
6. Touch **Threshold** and set the LIN signal's threshold voltage level by **Universal Knob**. The threshold voltage level is for decoding, and it will be regard as the trigger voltage level when set the trigger type to serial.
7. Touch  to return previous menu.
8. Touch **Configure** to enter the **BUS CONFIG** menu.
9. Touch **Baud** to set baud rate.
 - The baud rate can be set as predefined value.
 - If the desired baud rate is not listed, select **custom** option, press the Custom and turn the **Universal Knob** to set the desired baud rate.

7.5.2 LIN Trigger

This section provides a brief introduction and description for the operation of the LIN trigger.

Trigger Condition

- *Break* — the oscilloscope will be triggered at the position of break field's break delimiter.
- *ID* (Frame ID) — the oscilloscope will be triggered at the position of identifier field's stop bit, if the value of a frame's ID is equal to specified value. (Note: If the data's value is 0xXX, any data value will be matched)
- *ID + Data* (Frame ID and Data) — the oscilloscope triggers when a frame with an ID and data equal to the selected values is detected. Use the **Universal Knob** to select the value for the ID, Data1 and Data2.
 - a. The ID's value is the same as set value.
 - b. If you have set either Data1's or Data2's value, and the signal has a data is the same as that value. If you have set both Data1's and Data2's value, the signal should has two consecutive data, the first data's value is Data1, second data value is Data2.

Note:

If the data's value is 0xXX, any data value will be matched

- *Data Error* —the oscilloscope will be triggered when errors (such as ID check error, checksum error, sync byte field error) are detected.

Operation Steps

- Touch **Setup** key to enter the **TRIGGER** function menu.
- Touch **Type** and select **Serial**.
- Touch **Protocol** and select **I2C**.
- Touch **Trigger Setting** to enter **LIN TRIG SET** menu.
- Touch **Condition** and select the trigger condition by **Universal Knob**:
 - If you select **ID** condition:
 - Touch **ID** and set its value by turning the **Universal Knob**.
 - If you select **ID+DATA** condition:
 - Touch **ID** and set its value by turning the **Universal Knob**.
 - Touch **DATA1** and set its value by turning the Universal Knob.
 - Touch **DATA2** and set its value by turning the Universal Knob.

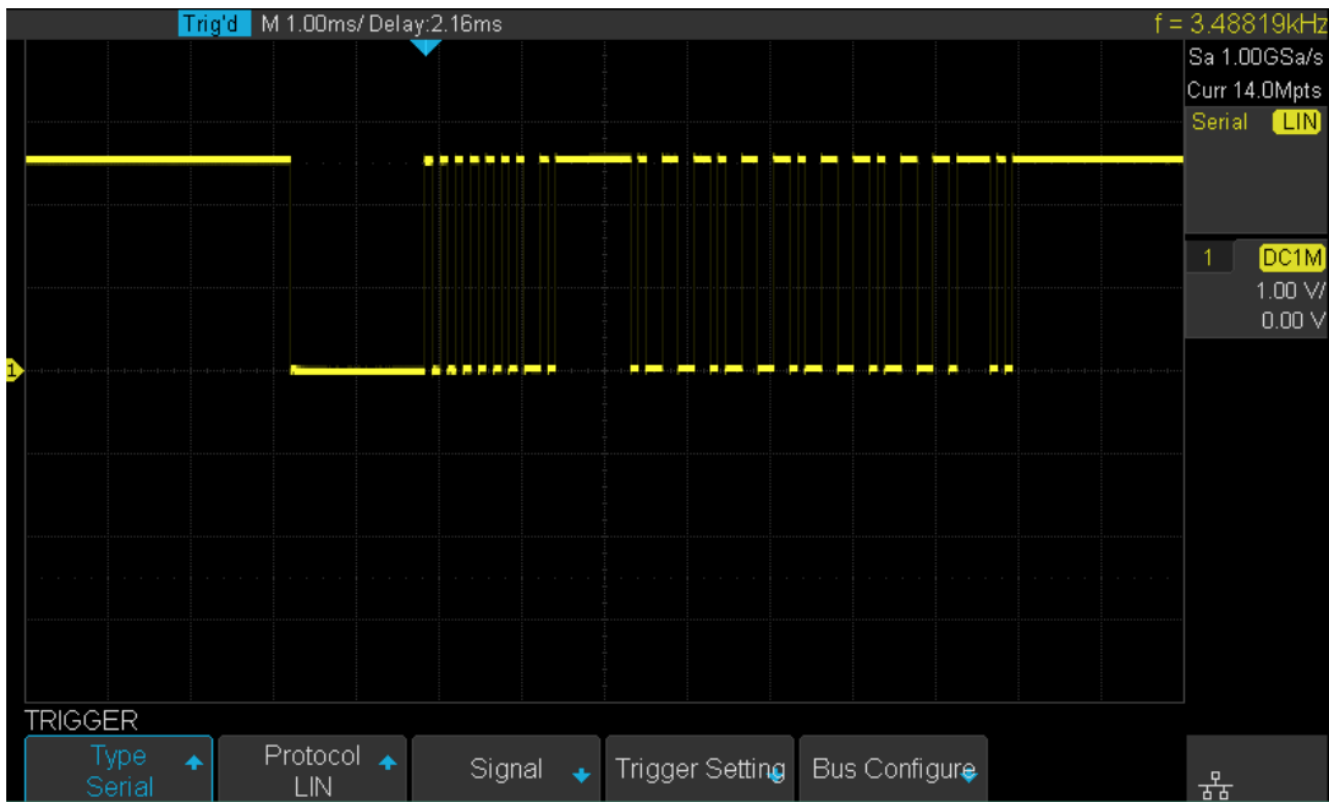



Figure 7.29 LIN Trigger

7.5.1 Interpreting LIN Decode

The frame of decoding result:

- Protected Identifier Field is displayed in frame
- Data Length is displayed in frame
- Data Field is displayed in frame.
- Checksum Field is displayed in frame.
-  Indicates there is not enough space on the display to show complete content of a frame and some content is hidden.

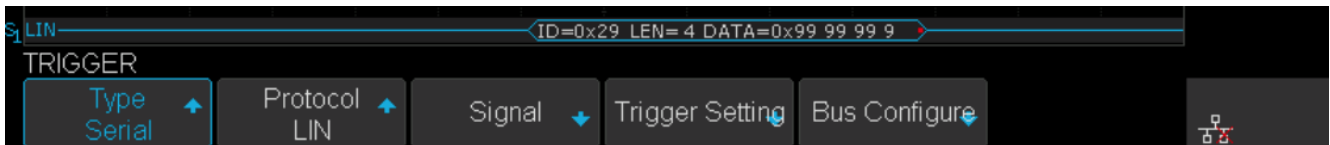

Figure 7.30 LIN Decode Bus Display

The list of decoding result:

- Time — the horizontal displacement between current frame and trigger position.
- ID — the value of frame's Protected Identifier Field.
- Data Length — the length of Data Field.
- ID Parity — the two check bits of Protected Identifier Field.
- Data — the value of Data Field.
- Checksum — the value of Checksum Field.

LIN	Time	ID	Data Length	ID Parity	Data	Checksum
1	-1.79606ms	0x29	4	0x03	0x99 99 99 99	0xAF

Figure 7.31 LIN Decode List Display

Reference Waveform

The oscilloscope can save analog channel or math waveforms to the reference waveform locations in the oscilloscope. Then, a reference waveform can be displayed and compared against other waveforms. All reference waveforms can be displayed at a time.

8.1 Save REF Waveform to Internal Memory

Do the following steps to save the REF waveform to internal memory:

1. Press the **REF** button on the front to enter the REF WAVE function menu. Note that when the time horizontal format is in X-Y mode, REF function cannot be enabled.
2. Press the **Source** softkey; then, turn the **Universal Knob** to select the source of reference channel. The source includes analog channel and math waveforms.
3. Press the **Location** softkey; then, turn the **Universal Knob** to select the position to save the REF waveform. The source includes analog channel and math waveforms.
4. Press the **Save** softkey to save the channel or math waveform to the appointed location. The vertical scale information and the vertical offset of the waveform will be saved at the same time. It will pop out the message “**Store Data Success**” when the waveform has been saved successfully.

Note:

The REF waveforms are non-volatile. The REF waveform can still be saved after restarts or default operation.

8.2 Display REF Waveform

To the following steps to display REF waveform:

1. Press the **REF** button on the front to enter the REF WAVE function menu.
2. Press the **Location** softkey; then, turn the **Universal Knob** to select the REF waveform that you want to display.
3. Press the **Display** softkey to select **On** to display the REF waveform on the screen. Only saved location can be displayed. The oscilloscope can display all four reference waveforms at a time.

8.3 Adjust REF Waveform

1. Refer to the **Display REF Waveform** section above to display the desired reference waveform.
2. Press the **Scale** and Position softkey and turn the **Universal Knob** to adjust the vertical scale and position of the reference waveform. The vertical scale and position information display at the middle of the screen. The initial values display at the middle of the screen is the setup that when the reference waveform been saved.

The initial values displayed in the middle of the screen is the setup of the reference saved waveform.

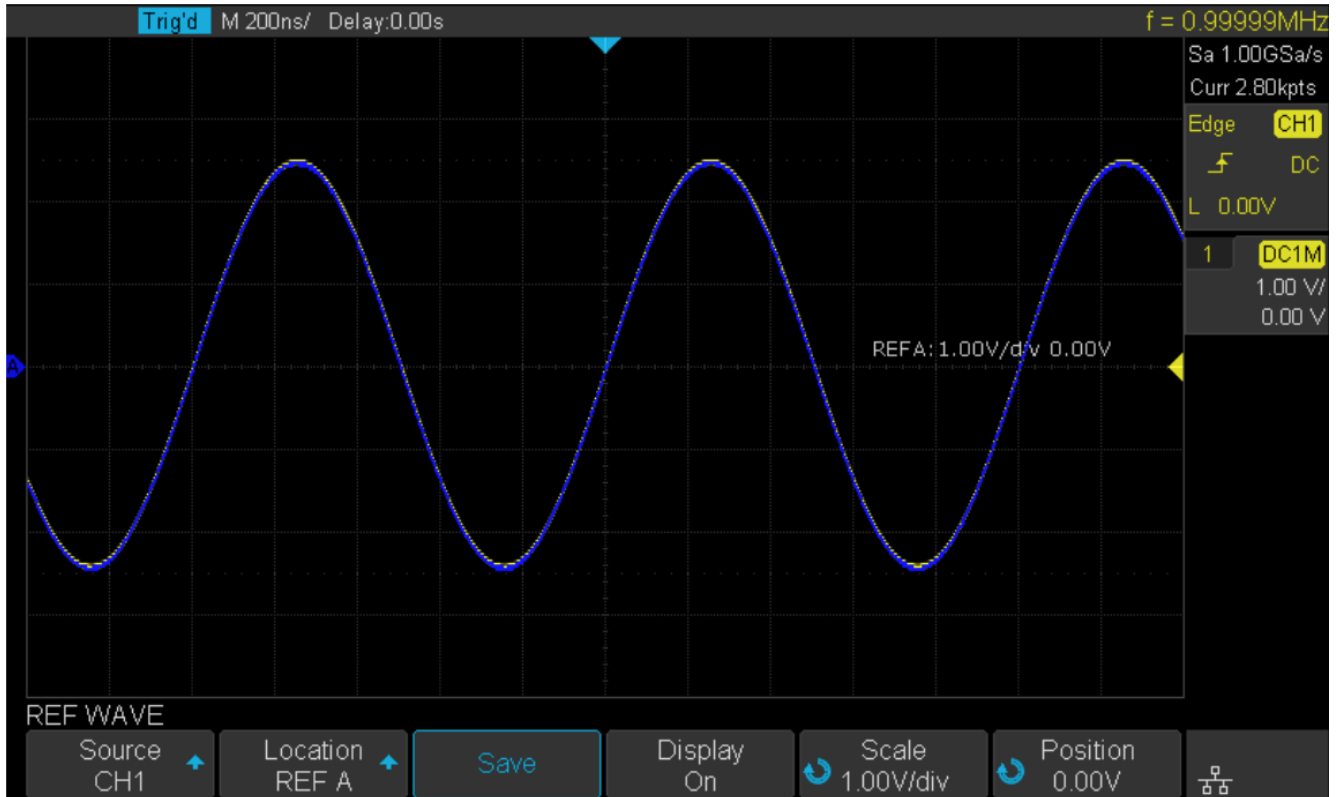

Figure 8.1 Reference Waveform

8.4 Clear Ref Waveform

The oscilloscope does not have the “Clear” option under the REF WAVE function menu.

To clear the appointed reference waveform, you can save a new reference waveform to the same location to cover it.

Or follow the **Save/Recall** → **Recall** → type and select **Security Erase** to clear the stored waveform.

Math

The oscilloscope supports many math operations between analog channels including addition (+), subtraction (-), multiplication (*), division (/), FFT, differential (d/dt), integral ($\int dt$), square root ($\sqrt{\quad}$). The resulting math waveform is displayed in white and labeled with "M". You can use cursors to measure it.

Note:

If the analog channel or the math function is cut off (waveforms do not display on the screen completely), the resulting math will also be cut off.

9.1 Units for Math Waveforms

Use the channel function menu to set the unit of each channel to "V" or "A".

The oscilloscope math operation includes units as below:

Math	Operation Unit
Addition (+) or subtraction (-)	V, A
multiplication (*)	V^2 , A^2 or W
division (/)	None, $V * A^{-1}$ or $V^{-1} * A$
FFT	dBVrms, Vrms, dBm, dBArms, Arms
differential (d/dt)	$V * S^{-1}$ or $A * S^{-1}$
integral (dt)	VS or AS (V * second or A * second)
square root ($\sqrt{\quad}$)	$V^{1/2}$ or $A^{1/2}$

Table 9.1 Math Operations Units

9.2 Math Operators

The oscilloscope supports math count operation (Addition, subtraction, multiplication, division), FFT (Fourier transform) operation, and math function operation (differential, integral, square root).

9.2.1 Addition or Subtraction

Math operators perform arithmetic operations add or subtract operation on any two analog input channels. When you select addition or subtraction, the **Source A** and **Source B** values are added or subtracted point by point, and the result is displayed.

1. Press the **Math** key on the front panel to enter the MATH function menu.
2. Press the **Source A** and **Source B** softkey respectively, and then turn the **Universal Knob** to select the source to do math operation. Addition or Subtraction can be applied between analog channels.
3. Press the **Operation** softkey and then turn the universal to select + or - to make addition or subtraction operation. The resulting math waveform is displayed in white and labeled with "M".

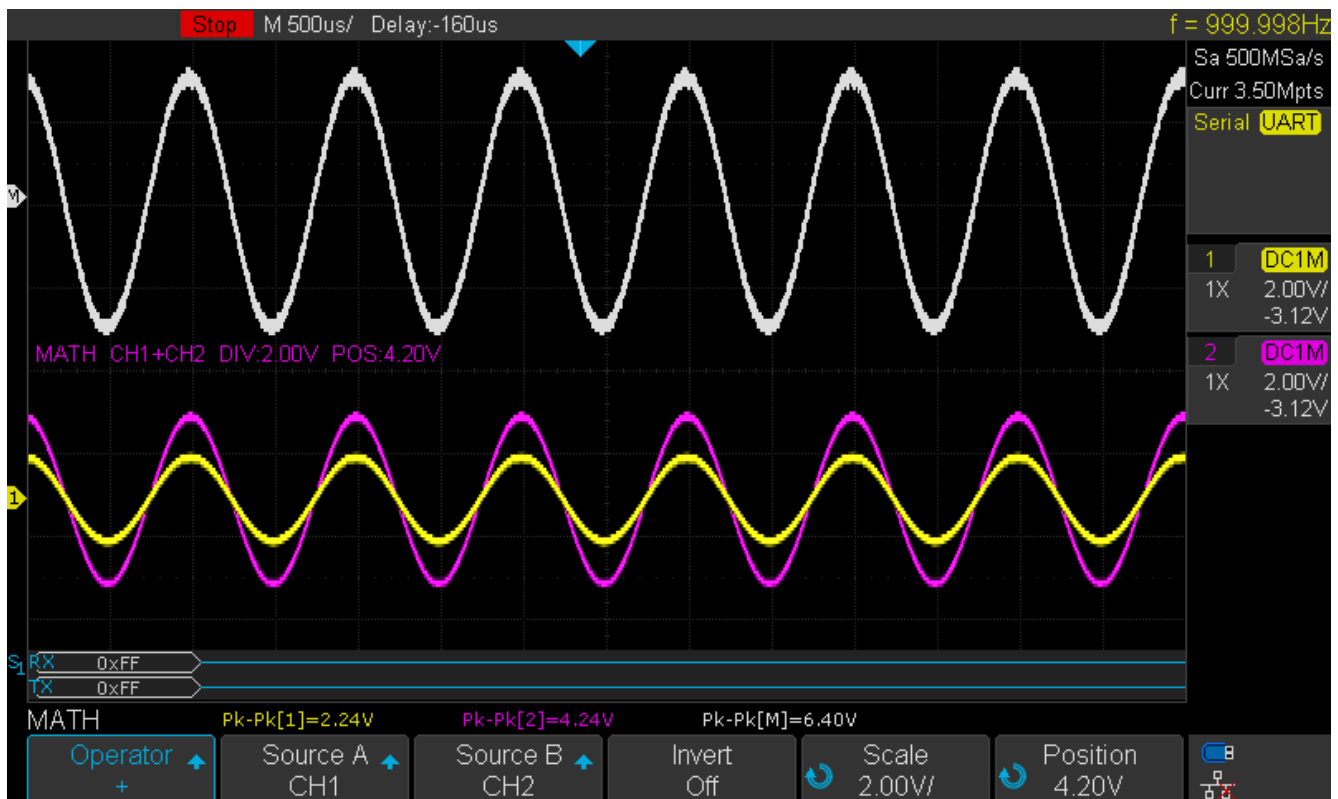

Figure 9.1 CH 1 + CH 2

4. To invert the math waveform, press the **Invert** button and set the option to **On** to invert the display of the math waveform.

9.2.2 Multiplication and Division

Math operators perform arithmetic operations add or subtract operation on any two analog input channels. When you select multiplication or division, the **Source A** and **Source B** values are added or subtracted point by point, and the result is displayed.

1. Press the **Math** key on the front panel to enter the MATH function menu.
2. Press the **Source A** and **Source B** softkey respectively, and then turn the **Universal Knob** to select the source to do math operation. Addition or Subtraction can be applied between analog channels.
3. Press the **Operation** softkey and then turn the universal to select * or / to make addition or subtraction operation. The resulting math waveform is displayed in white and labeled with "M".

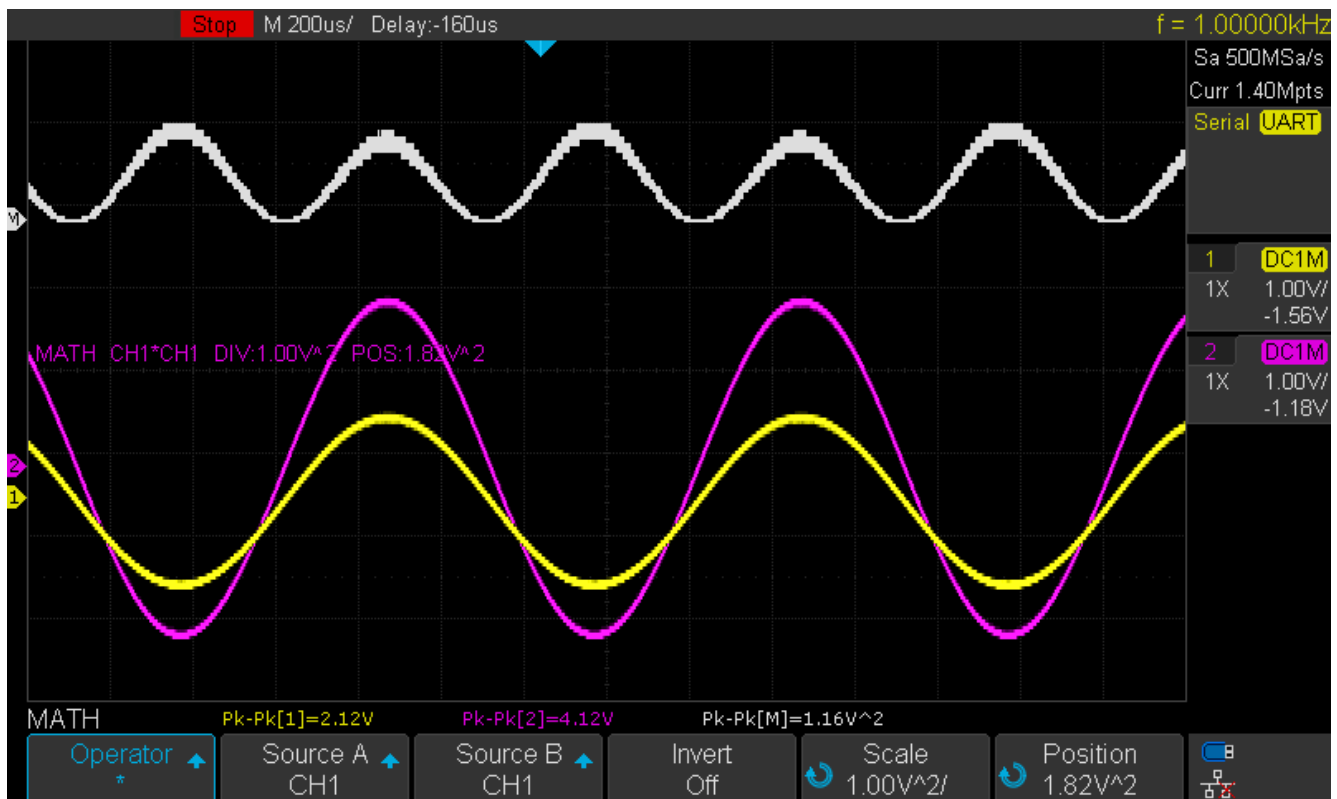

Figure 9.2 CH 1 * CH 2

4. To invert the math waveform, press the **Invert** button and set the option to **On** to invert the display of the math waveform.

9.2.3 FFT Operation

FFT is used to compute the fast Fourier transform using analog input channels. FFT takes the digitized time record of the specified source and transforms it to the frequency domain. When the FFT function is selected, the FFT spectrum is plotted on the oscilloscope display as magnitude in dBV versus frequency. The readout for the horizontal axis changes from time to frequency (Hertz) and the vertical readout changes from V to dB.

FFT operation can facilitate the following works:

- Measure harmonic components and distortion in the device under test
- Measure the characteristics of the noise in DC power
- Analyze vibration

To display a FFT waveform

1. Press the **Math** key on the front panel to open the MATH function menu.
2. Press the **Operator** softkey and then turn the **Universal Knob** to select **FFT**. The resulting math waveform is displayed in white and labeled with "M".

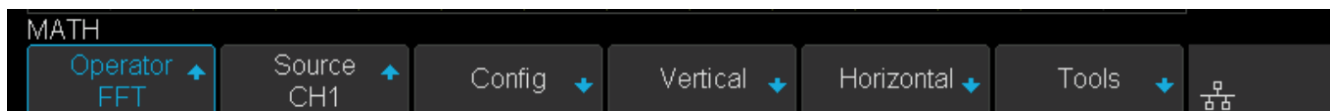

Figure 9.3 FFT Menu

3. Press the **Source** softkey, and then turn the **Universal Knob** to select the source to do FFT operation. Analog channels can be used as the source.
4. Press the **Config** softkey to enter CONFIG menu.

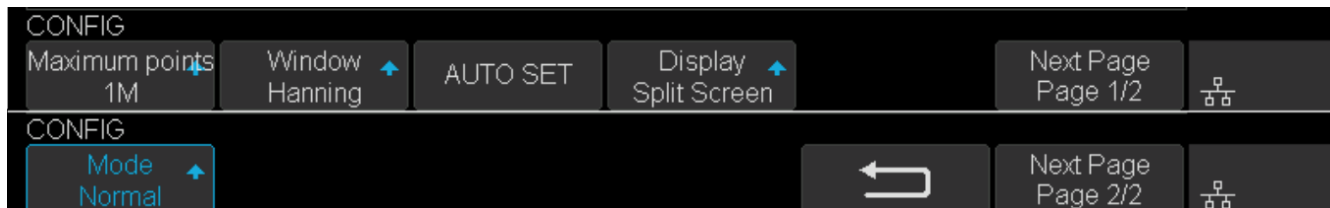

Figure 9.4 FFT Config Menu

- Press the **Maximum points** softkey, and then turn the **Universal Knob** to select the Maximum points.
- Press the **Window** softkey, and then turn the **Universal Knob** to select an appropriate window. Spectral leakage can be considerably decreased when a window function is used. The oscilloscope provides five windows (Rectangle, Blackman, Hanning, Hamming and Flattop) which have different characteristics and are applicable to measure different waveforms. Select the window function according to different waveforms and their characteristics. Refer to table 9.2 to make an appropriate option according to the input signal.

Window	Applications and Characteristics
Rectangle	These are normally used when the signal is transient (completely contained in the time-domain window) or known to have a fundamental frequency component that is an integer multiple of the fundamental frequency of the window. Signals other than these types will show varying amounts of spectral leakage and scallop loss, which can be corrected by selecting another type of window.
Hanning	These reduce leakage and improve amplitude accuracy. However, frequency resolution is also reduced.
Hamming	These reduce leakage and improve amplitude accuracy. However, frequency resolution is also reduced.
Flat Top	This window provides excellent amplitude accuracy with moderate reduction of leakage, but with reduced frequency resolution.
Blackman	It reduces the leakage to a minimum, but with reduced frequency resolution.

Table 9.2 FFT Window

- Press the **Auto set** softkey to automatically set the appropriate parameters for the FFT measurement.
 - Press the **Display** softkey to select **Split**, **Full Screen** or **Exclusive** display mode.
 - Split:* Time domain waveform and frequency domain waveform are displayed separately. The time domain waveform is on the upper half screen, while the frequency domain waveform is located within the lower half of the display. In Split mode, if Zoom is enabled, the zoom waveform and the frequency domain waveform are displayed on the lower half screen together.
 - Full Screen:* Time-domain waveform and frequency-domain waveform are displayed together.
 - Exclusive:* Only the frequency-domain waveform is displayed.
 - Press the **Mode** softkey to select **Normal**, **Max-Hold** or **Average**. When you select Average, it is necessary to set the average times.
5. Press the **Vertical** softkey to enter VERTICAL menu.



Figure 9.5 Vertical Menu

- Press the **Scale** softkey, and then turn the **Universal Knob** to select the desired vertical FFT scale
 - Press the **Ref Level** softkey, and then turn the **Universal Knob** to select the desired vertical FFT offset.
 - Press the **Unit** softkey to select the unit of vertical axis. The units of the vertical axis can be dBVrms, dBm, Vrms or dBArms, Arms, which use a logarithmic scale or a linear scale to display vertical amplitude respectively.
 - Press the **Ext Lode** softkey and then turn the **Universal Knob** to select the external load value.
5. Press the **Horizontal** softkey to enter HORIZONTAL menu.



Figure 9.6 Horizontal Menu

- Press the **Center** softkey, and then turn the **Universal Knob** to select the desired center frequency.
- Press the **Hz/div** softkey, and then turn the **Universal Knob** to select the desired resolution frequency.

6. Press the **Tools** softkey to enter TOOLS menu. Press the **Type** softkey to select the type of tools. The type of the tools can be **Peaks**, **Markers**, or **Off**. *Peaks*: Automatically mark the peak of the current FFT waveform according to the search configuration.

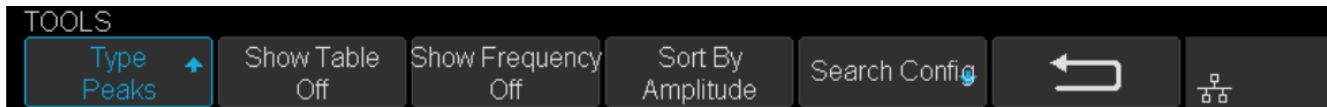

Figure 9.7 FFT Peaks Menu

- Press the **Show Table** softkey to display a table of peak, and press Show Frequency softkey to display the frequency value of the peak. Press the **Sort By** softkey continuously to set the table sorting by Amplitude or Frequency.
- Press the **Search Config** softkey to set search configuration.



Figure 9.8 Search Config Menu

- a. Press the **Threshold** softkey and turn the **Universal Knob** to set the minimum peak amplitude. Only peaks larger than the peak limit can be judged as peaks.
- b. Press the **Excursion** softkey and turn the **Universal Knob** to set the difference between the peak value and the minimum Amplitude on both sides. Only when the difference is greater than the peak value of peak offset can the peak value be determined.

Markers: Customize the marker locations on the FFT waveform based on search configuration.

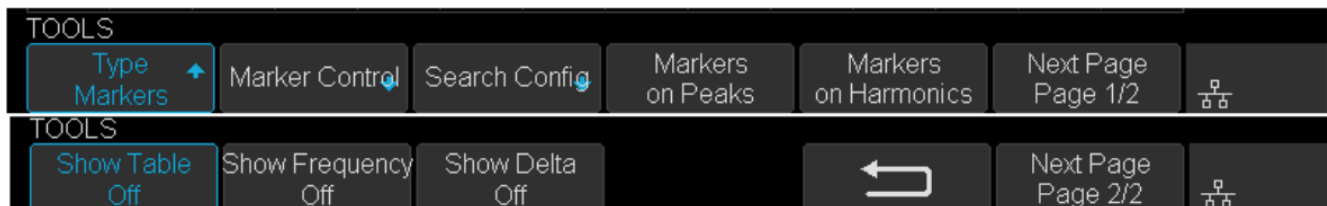

Figure 9.9 FFT Markers Menu

- Press Markers Control softkey to enter MARKER Menu.

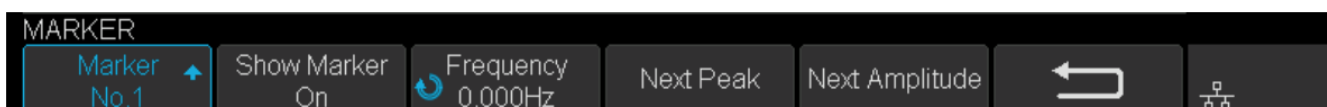

Figure 9.10 Marker Control Menu

- a. Press the **Marker** softkey continuously to select the marker number from NO.1 NO.8.
 - b. Press the **Show Marker** softkey continuously to turn on or off the selected mark.
 - c. Press the **Frequency** softkey to set the frequency value of the selected marker.
 - d. Press the **Next Peak** softkey to move the selected mark to the next peak. And press the **Next Amplitude** softkey to move the selected marker to the next peak with lower amplitude.(Up to 10 peaks are supported)
- Press the **Search Config** softkey to enter the SEARCH menu. Similar to the **search configuration** for peak markers.

- Press the **Markers on Peaks** softkey to set the markers on peaks, and press the **Markers on harmonics** softkey to set the markers on harmonics.
- Press the **Show Table** softkey to show the amplitude of the markers; press the **Show Frequency** softkey to show the frequency value of the markers, and press the **Show Delta** softkey to show the delta amplitude between markers.

Figure 9.11 shows the FFT waveform displayed on the split screen and the peak tool is turned on:

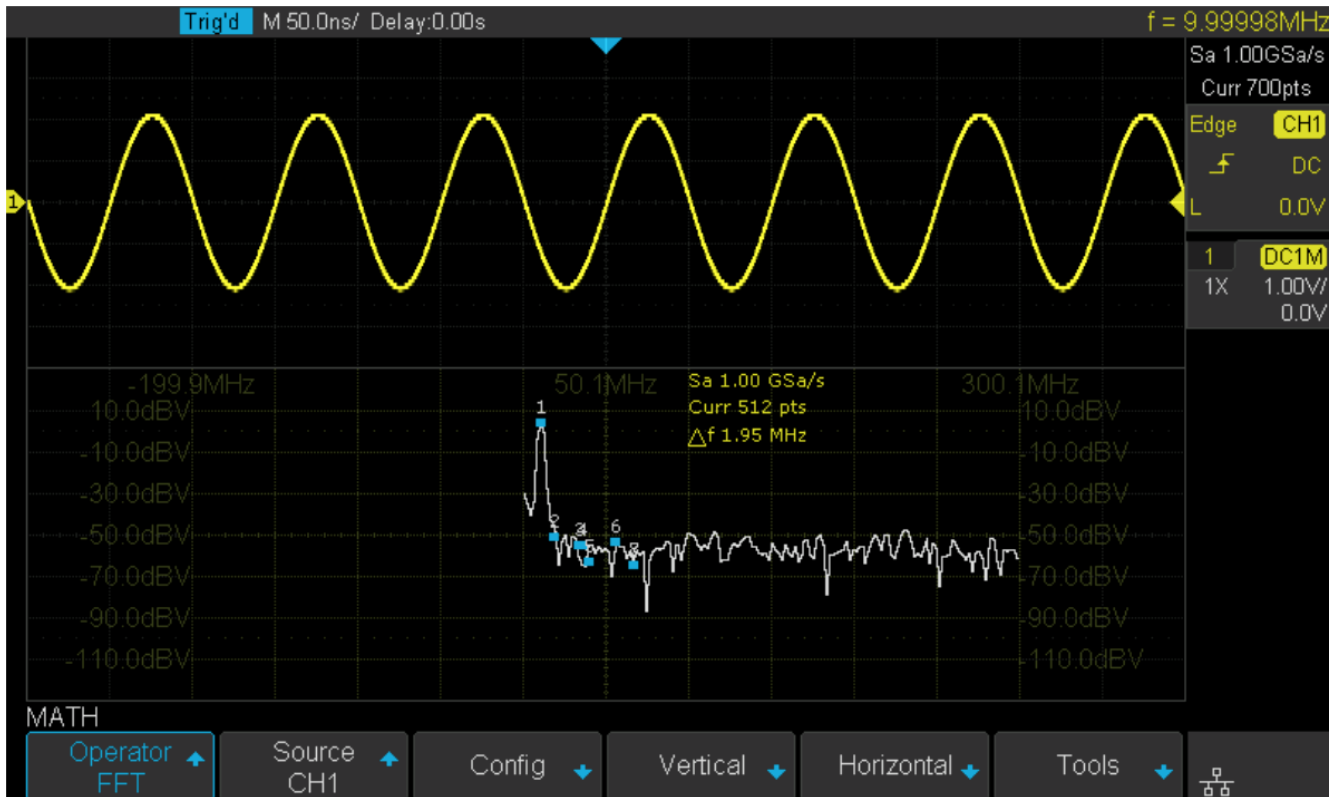

Figure 9.11 FFT Waveform

Note:

- Signals with DC components or deviation would cause error or deviation of the FFT waveform components. To reduce the DC components, set the Channel **Coupling** to AC.
- To reduce the random noise and aliasing frequency components of repetitive or single pulse, set the **Acquisition** of the oscilloscope to Average.

Measure FFT Waveform

To make cursor measurements, press the **Cursors** key, and then press the **Mode** softkey to select **On** to turn the cursors. Use the X1 and X2 cursors to measure frequency values and the difference between two frequency values (ΔX). Use the Y1 and Y2 cursors to measure amplitude in dB and difference in amplitude (ΔY). You can find the frequency value at the first occurrence of the waveform maximum by using the X at Max Y measurement.

Note:

Refer to the **Cursors** section for a description on using cursors.

9.3 Math Function Operation

The oscilloscope supports math function operation including differential (d/dt), integral ($\int dt$) and square root ($\sqrt{\quad}$).

9.3.1 Differentiate

$$di = \frac{y(i + \Delta t) - y(i - \Delta t)}{2\Delta t}$$

d/dt (differentiate) calculates the discrete time derivative of the selected source. Where:

- d = differential waveform
- y = channel 1, 2, 3, or 4 data points
- i = data point index
- Δt = point- to- point time difference

The **dx** option under d/dt math function operation menu shows the point- to- point time difference, and it ranges from 0.02div to 0.40div. “div” indicates the number of the pixel points that each division has. The oscilloscope has 50 pixel points per division. Take 0.2div as an example: $0.2 * 50 = 10$. It means to calculate the ten point's discrete time derivative of the selected source, and the Δt is the ten point's point-to-point time difference.

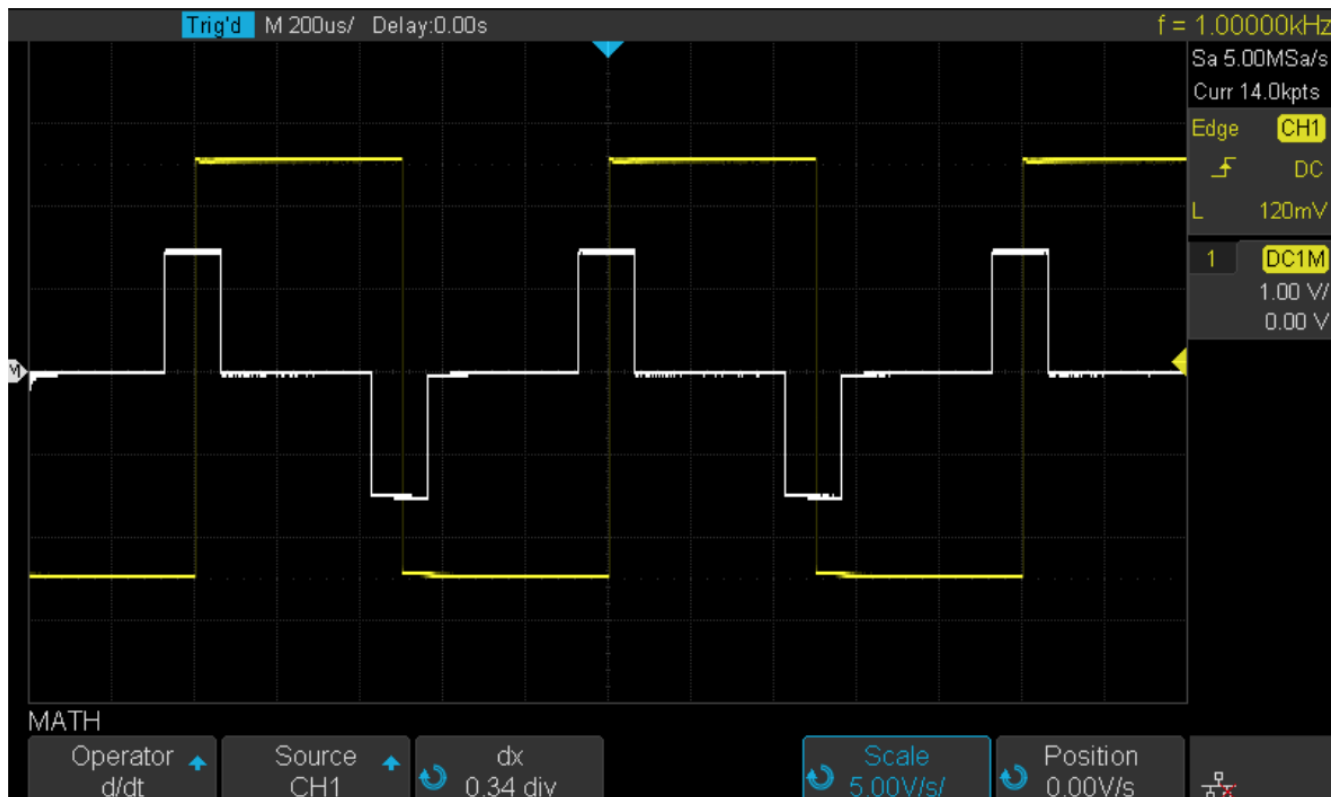

Figure 9.12 Difference Function Operation

You can use differentiate to measure the instantaneous slope of a waveform. For example, the slew rate of an operational amplifier may be measured using the differentiate function

Note:

Because differentiation is very sensitive to noise, it is helpful to set acquisition mode to Average.

9.3.2 Integrate

dt (integrate) calculates the integral of the selected source. You can use integrate to calculate the energy of a pulse in volt-seconds or measure the area under a waveform.

dt plots the integral of the source using the "Trapezoidal Rule". The equation is:

$$I_n = c_0 + \Delta t + \sum_{i=0}^n y_i$$

Where:

- I = integrated waveform
- Δt = point- to- point time difference
- y = channel 1, 2, 3, or 4 data points
- c_0 = arbitrary constant
- i = data point index

The integrate operator provides an **Offset** softkey that lets you enter a DC offset correction factor for the input signal. Small DC offset in the integrate function input (or even small oscilloscope calibration errors) can cause the integrate function output to "ramp" up or down. This DC offset correction lets you level the integrate waveform.

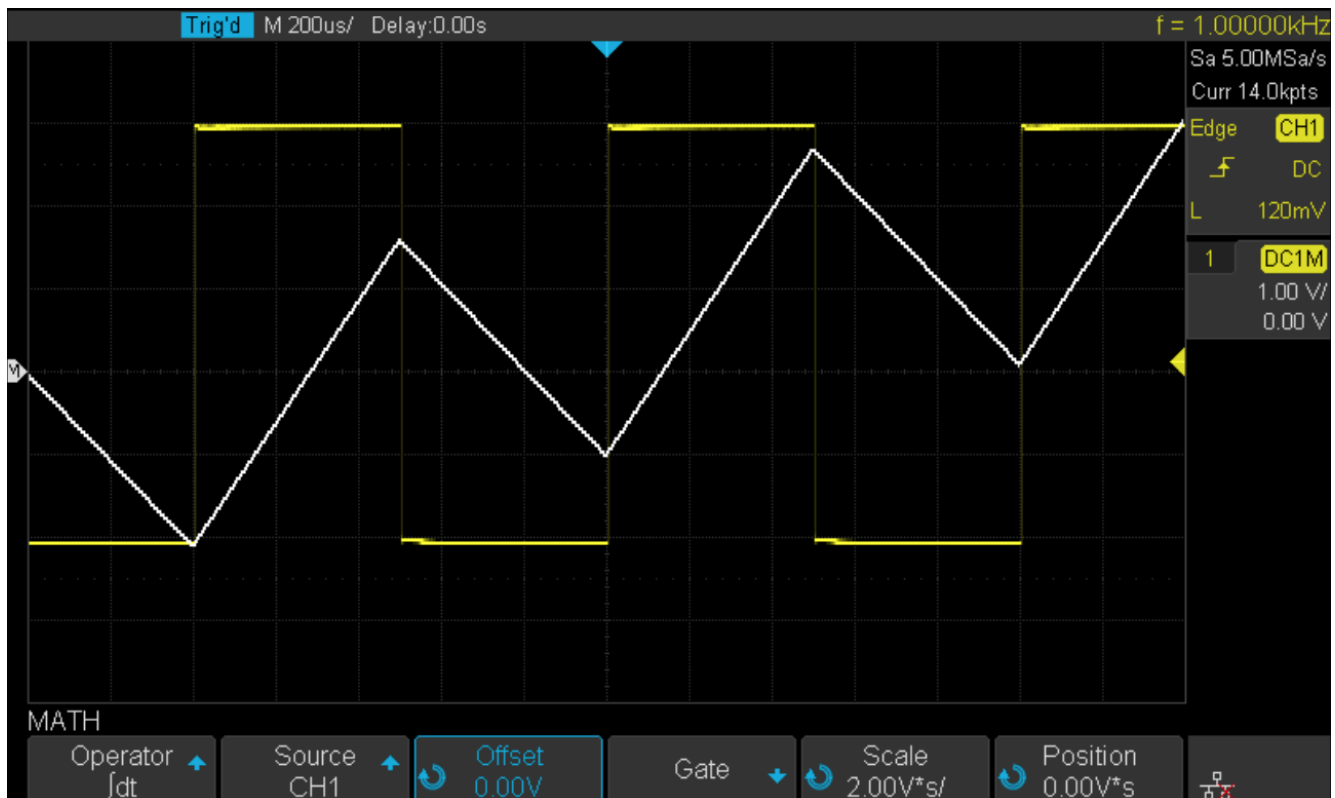

Figure 9.13 Integral with Offset

9.3.3 Square Root

Square root ($\sqrt{\quad}$) calculates the square root of the selected source. Where the transform is undefined for a particular input, holes (zero values) appear in the function output.

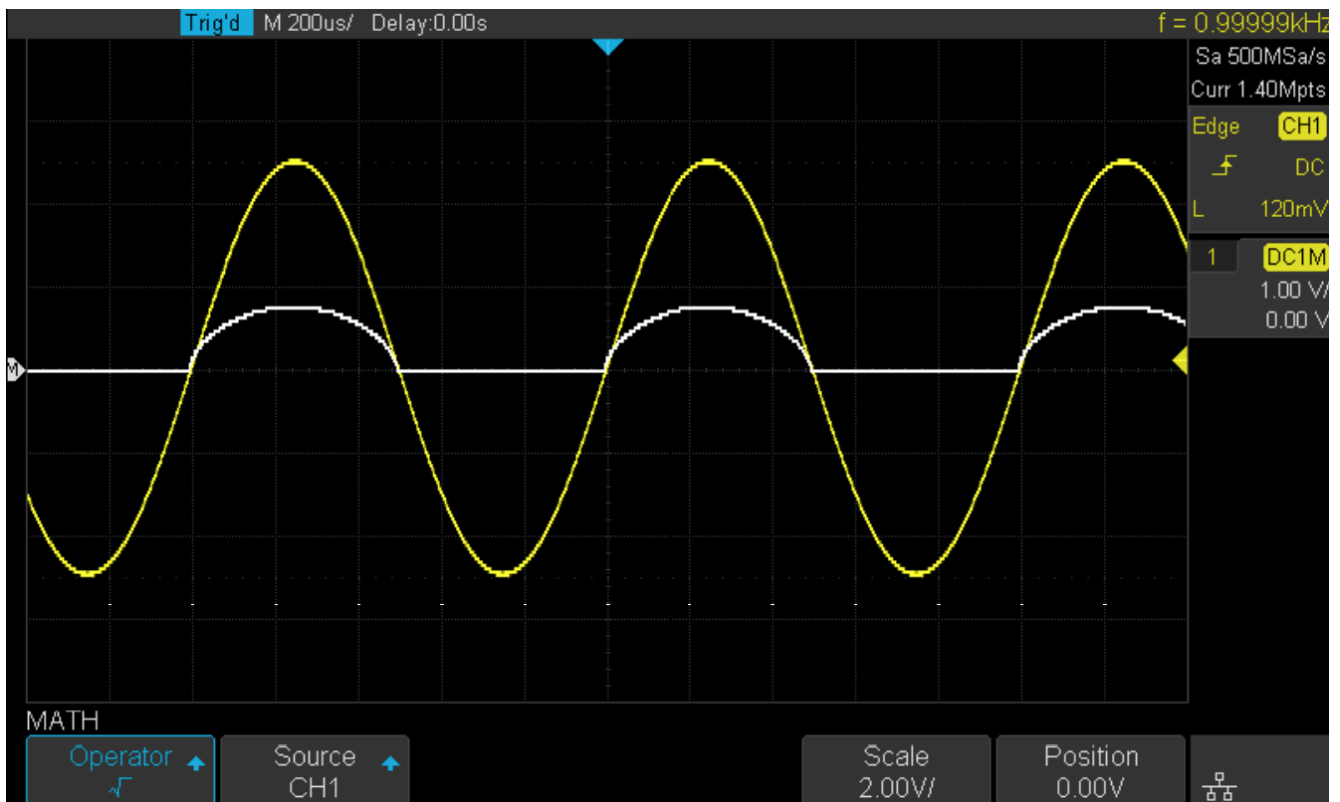

Figure 9.14 Square Root

Cursors

Cursors are horizontal and vertical markers that indicate X-axis values and Y-axis values on a selected waveform source. Cursors can be used to make custom voltage and time measurements on the oscilloscope signals.

10.1 X Cursors

X cursors are vertical dashed lines that adjust horizontally and can be used to measure time (when the source is FFT waveform, X cursors measure frequency).

X1 cursor is the left (default position) vertical dotted line; it can be moved to any place of the screen.

X2 cursor is the right (default position) vertical dotted line; it can be moved to any place of the screen.

Use the **Universal Knob** to set the X1 and X2 cursor values. The values are displayed in the cursors box along with the difference between X1 and X2 (T) and 1/T. (See figure 10.1)

When cursor type is set to X2-X1, use **Universal Knob** to move the X1 and X2 cursors together. The value under the menu option is the difference between the X1 and X2 cursors.

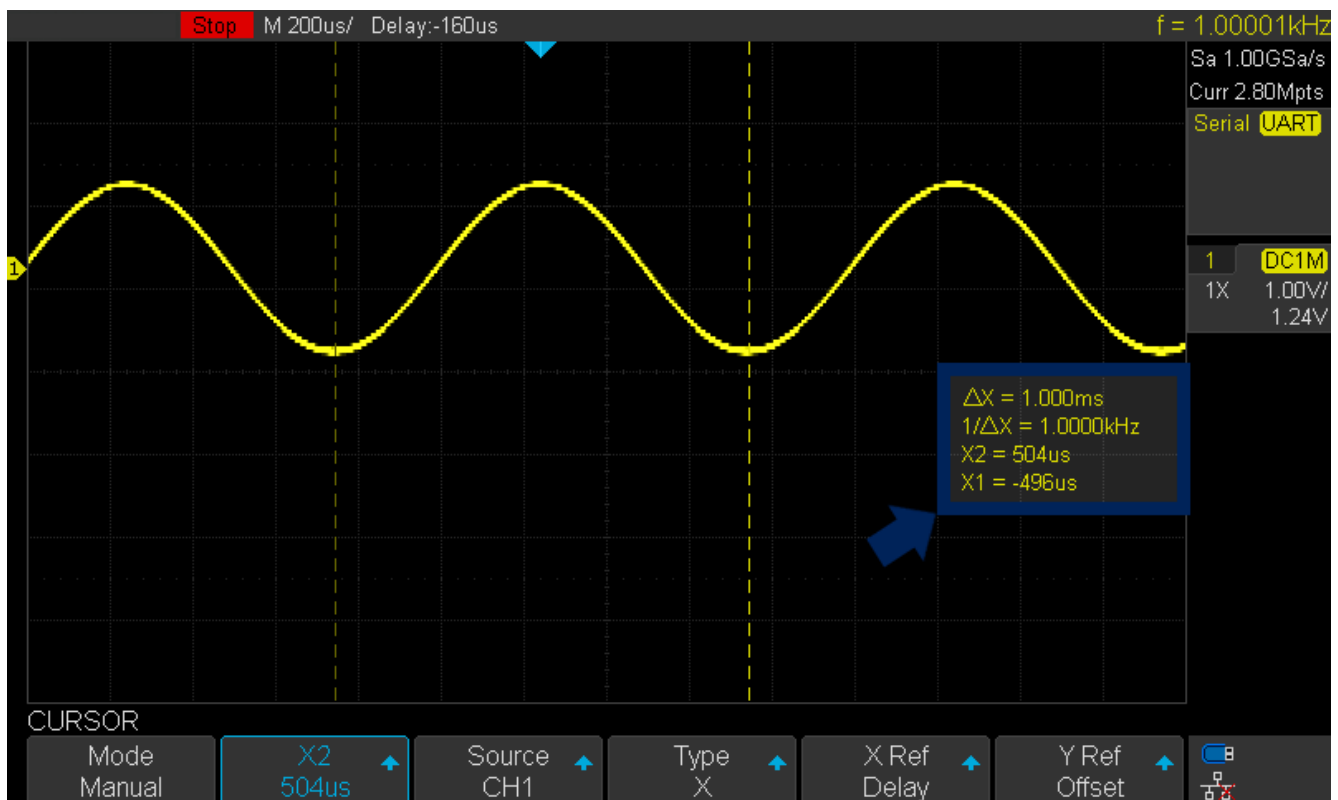

Figure 10.1 X Cursors Box

10.2 Y Cursors

Y cursors are horizontal dotted lines that adjust vertically and can be used to measure voltage (V) or current (A). When the cursors source is the math function, the unit will match the math function.

Y1 cursor is the top (default position) horizontal dotted line; it can be moved to any vertical place of the screen.

Y2 cursor is the down (default position) horizontal dotted line; it can be moved to any vertical place of the screen.

Use the **Universal Knob** to set the Y1 and Y2 cursor values and the values are displayed in the cursors box along with the difference between Y1 and Y2 (Y). (See figure 10.2)

When set cursor type to Y2-Y1, use Universal Knob will move the Y1 and Y2 cursors together. The value under the menu option is the difference between the Y1 and Y2 cursors.

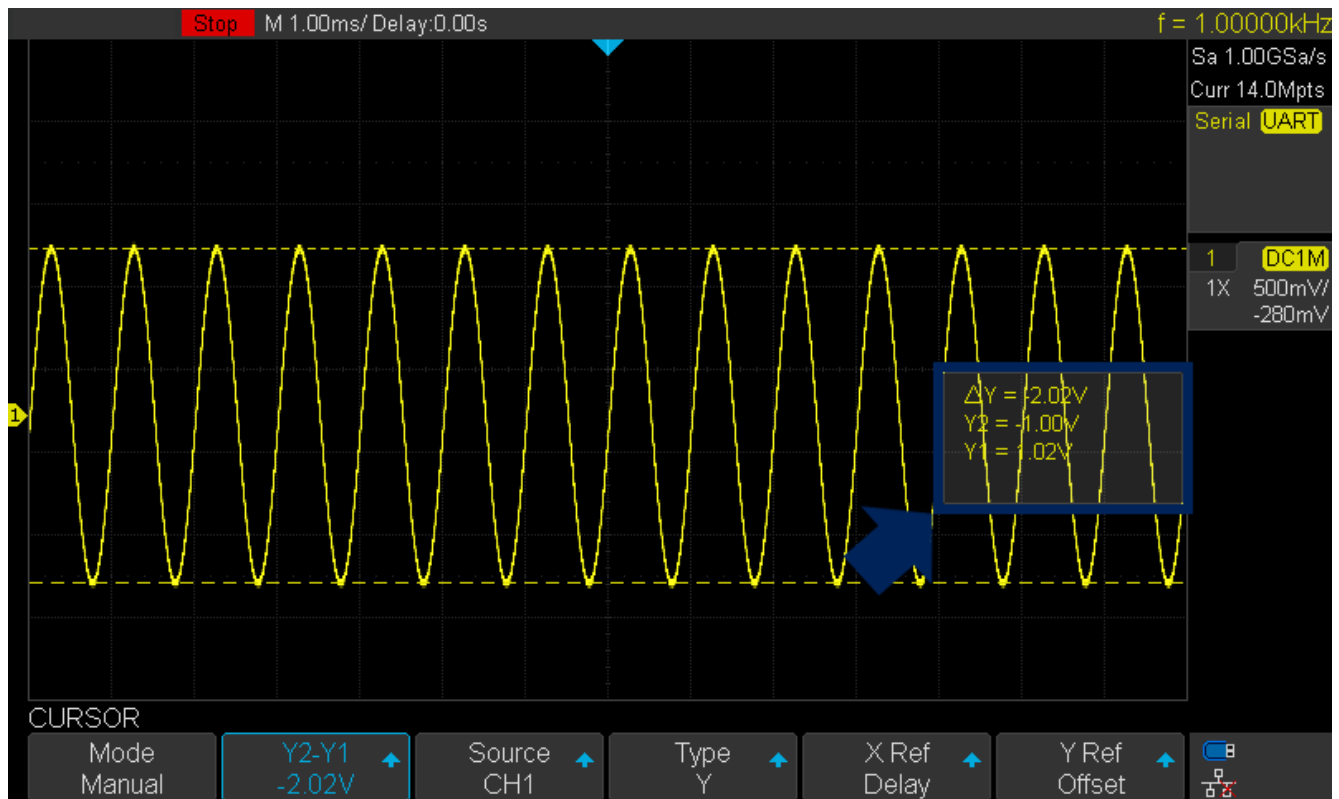

Figure 10.2 Y Cursors Box

10.3 Make Cursor Measurements

1. Press the **Cursors** key on the front panel to enter the CURSOR function menu.
2. Press the **Mode** softkey and set the cursors mode to Manual or Track.
3. Press the **Source** softkey, and then use the **Universal Knob** to select the desired source. Only analog channels, math waveforms and reference waveforms that are displayed are available for cursors.
4. Press the **X Ref** and **Y Ref** softkey to set the reference of X cursors and Y cursors.
 - **Position:** when the horizontal/vertical scale is changed, the X/Y cursors remain fixed to the grid position on the display.
 - **Delay/Offset:** when the horizontal/vertical is changed, the value of X/Y cursors remain fixed.
5. To make cursor measurements:
 - To measure the horizontal time, use the **Universal Knob** to move the X1 and X2 cursors to desired place. If necessary, set the cursor type to X2-X1, move X1 and X2 cursors together.
 - To measure vertical voltage or current, use the **Universal Knob** to move the Y1 and Y2 cursors to desired place. If necessary, set the cursor type to "Y2-Y1", move Y1 and Y2 cursors together.
 - To adjust the transparency of the cursors message box, press the **Display/Persist** softkey and go to the second page, press the **Transparence** (20% to 80%) softkey and then turn the **Universal Knob** to adjust the transparence to the desired value.

Cursor examples:

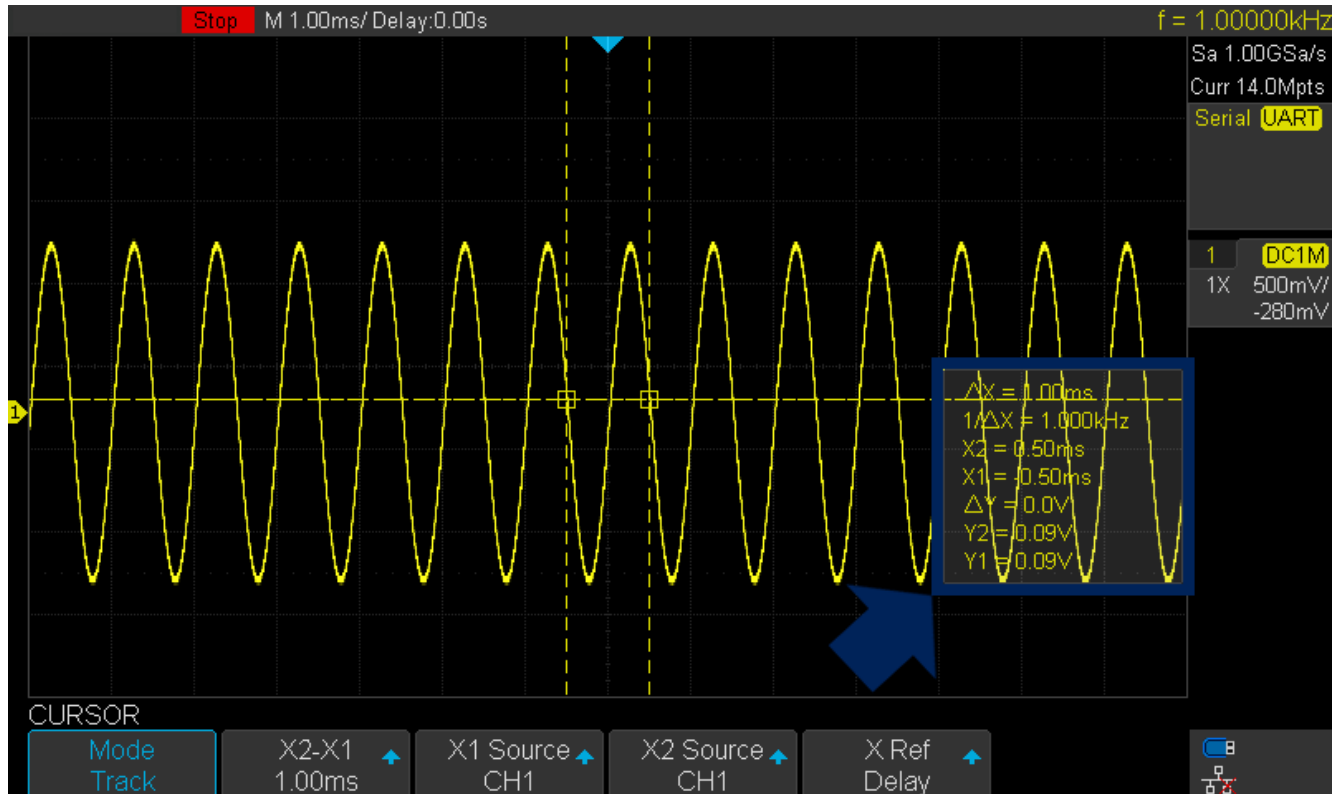

Figure 10.3 Cursor Track Mode

Measure

The oscilloscope provides measurements of 36 waveform parameters and the statistics. It contains voltage, time, and delay parameters.

Voltage and time parameters are under Type option. The results of the last four selected measurements are displayed at the bottom of the screen and above the menu. Delay parameters are under **All Measure** submenu. Set the Delay option to On to display all the delay parameters.

11.1 Type of Measurement

11.1.1 Voltage Measurements

Voltage measurements include 15 kinds of voltage parameters measurements.

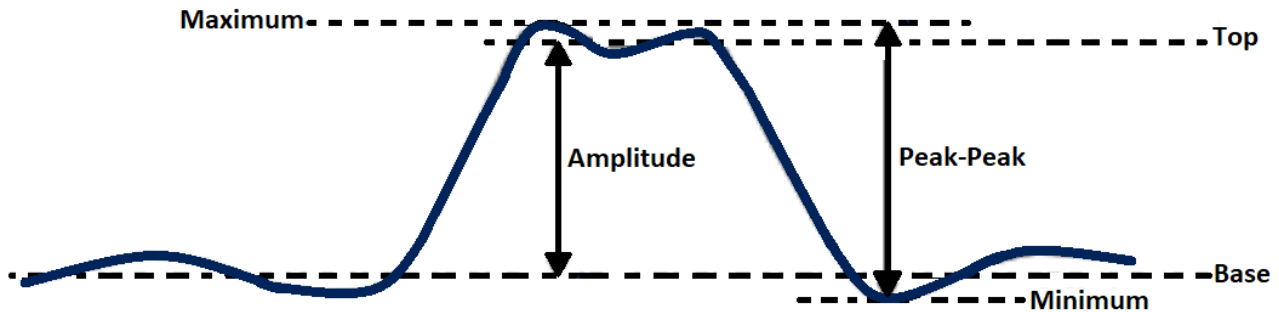

Figure 11.1 Voltage Measurements

1. Peak-Peak: Difference between maximum and minimum data values.
2. Maximum: Highest value in input waveform.
3. Minimum: Lowest value in input waveform.
4. Amplitude: Difference between top and base in a bimodal signal, or between max and min in a unimodal signal.
5. Top: Value of most probable higher state in a bimodal waveform.
6. Base: Value of most probable lower state in a bimodal waveform.
7. Mean: Average of all data values
8. Cycle mean: Average of data values in the first cycle.
9. Stdev: Standard deviation of all data values
10. Cycle Stdev: Standard deviation of all data values in the first cycle
11. Rms: Root mean square of all data values.
12. Cycle RMS: Root mean square of all data values in the first cycle.

13. Overshoot: Overshoot is distortion that follows a major edge transition expressed as a percentage of Amplitude. ROV means rising edge overshoot and FOV means falling edge overshoot.

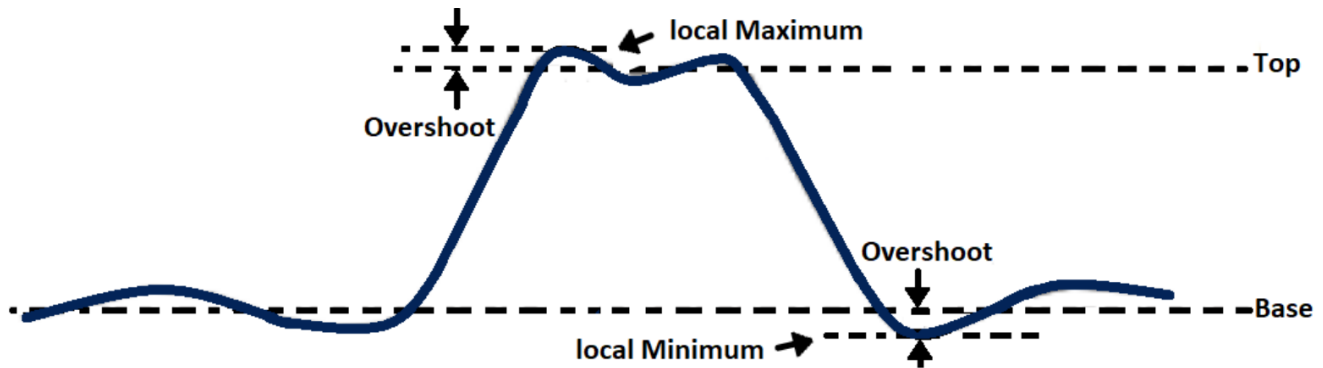

Figure 11.2 Overshoot

$$\text{Rising edge overshoot} = \frac{\text{local Maximum} - D \text{ Top}}{\text{Amplitude}} \times 100$$

$$\text{Falling edge overshoot} = \frac{\text{Base} - D \text{ local Minimum}}{\text{Amplitude}} \times 100$$

14. Preshoot: Preshoot is distortion that precedes a major edge transition expressed as a percentage of Amplitude. The X cursors show which edge is being measured (edge closest to the trigger reference point).

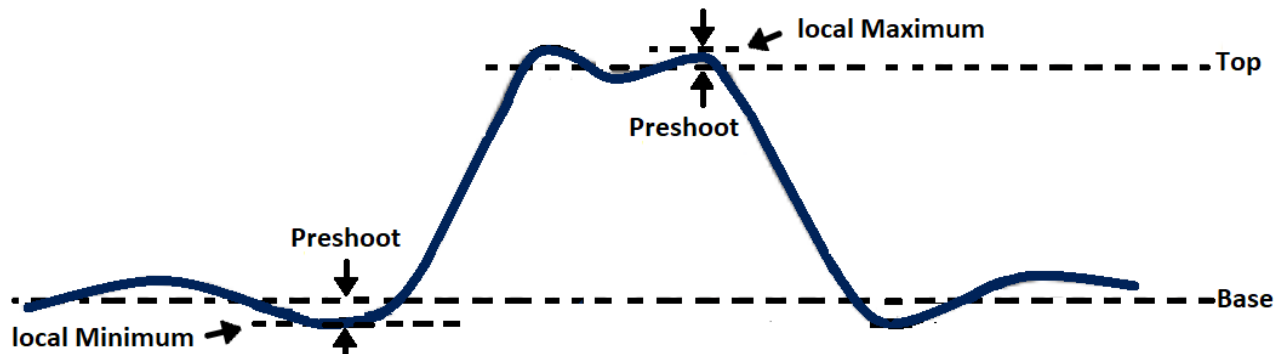

Figure 11.3 Preshoot

$$\text{Rising edge preshoot} = \frac{\text{local Minimum} - D \text{ Top}}{\text{Amplitude}} \times 100$$

$$\text{Falling edge preshoot} = \frac{\text{Base} - D \text{ local Maximum}}{\text{Amplitude}} \times 100$$

15. Level@X: The voltage value between the trigger point and the vertical position of the channel

11.1.2 Time Measurements

Time measurements includes 11 types of time parameter measurements.

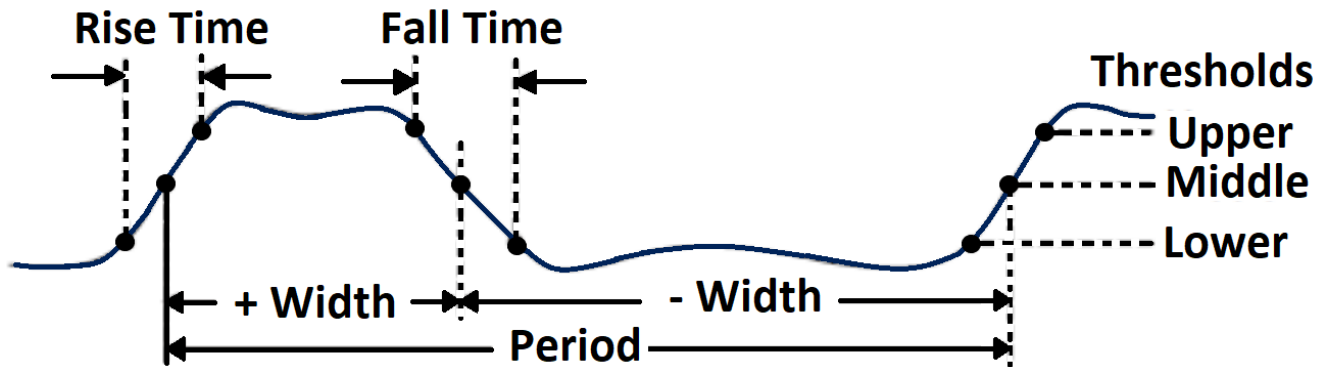

Figure 11.4 Time Measurements

1. Period: Period for every cycle in waveform at the 50% level, and positive slope.
2. Frequency: Frequency for every cycle in waveform at the 50% level ,and positive slope
3. + Width: Width measured at 50% level and positive slope.
- Width: Width measured at 50% level and negative slope.
4. Rise Time: Duration of rising edge from 10-90%.
5. Fall Time: Duration of falling edge from 90-10%.
6. BWid: Time from the first rising edge to the last falling edge, or the first falling edge to the last rising edge at the 50% crossing.
7. + Duty: Ratio of positive width to period.
- Duty: Ratio of negative width to period.
8. Delay Time from the trigger to the first transition at the 50% crossing.
9. T@LTime from trigger of each transition at a specific level and slope, include: Current, Max, Min, Mean, and Std-dev.

11.1.3 Delay Measurements

Delay measurements measure the time different between arbitrary two channels, including 10 types of delay measurements.

1. Phase: Calculate the phase difference between two edges.
2. FRFR: Time between the first rising edges of the two channels.
3. FRFF: Time from the first rising edge of channel A to the first falling edge of channel B.
4. FFFR: Time from the first falling edge of channel A to the first rising edge of channel B.
5. FFFF: Time from the first falling edge of channel A to the first falling edge of channel B.
6. FRLR: Time from the first rising edge of channel A to the last rising edge of channel B.
7. FRLF: Time from the first rising edge of channel A to the last falling edge of channel B.
8. FFLR: Time from the first falling edge of channel A to the last rising edge of channel B.

9. **F_{FLF}**: Time from the first falling edge of channel A to the last falling edge of channel B.
10. **Skew**: Time of source A edge minus time of nearest source B edge.

11.2 Automatic Measurement

Perform the steps below and select voltage or time parameters to make automatic measurement.

1. Press the **Measure** key on the front panel to enter the MEASURE function menu. At the same, the frequency and period are enabled with the current trigger channel, the statistics also was enabled.
2. Press the **Source** softkey, and then use the **Universal Knob** to select the desired channel. Only analog channels that are displayed are available for measurements.
3. To select and display measurement parameters. Press the **Type** softkey, and then turn the **Universal Knob** to select the desired measurement parameter.
4. Press the **Universal Knob** to add the measurement parameter, the parameters and value will be shown above the menu, and the statistics status will update.
5. To turn off the statistic function, press the **Statistics** softkey to select **Off**.

The measurement display area can display 4 measurement parameters at most, and the measurements will arrange according to the selecting order. If a fifth measurement is added, the first measurement will be deleted.



Figure 11.5 Measurement Type

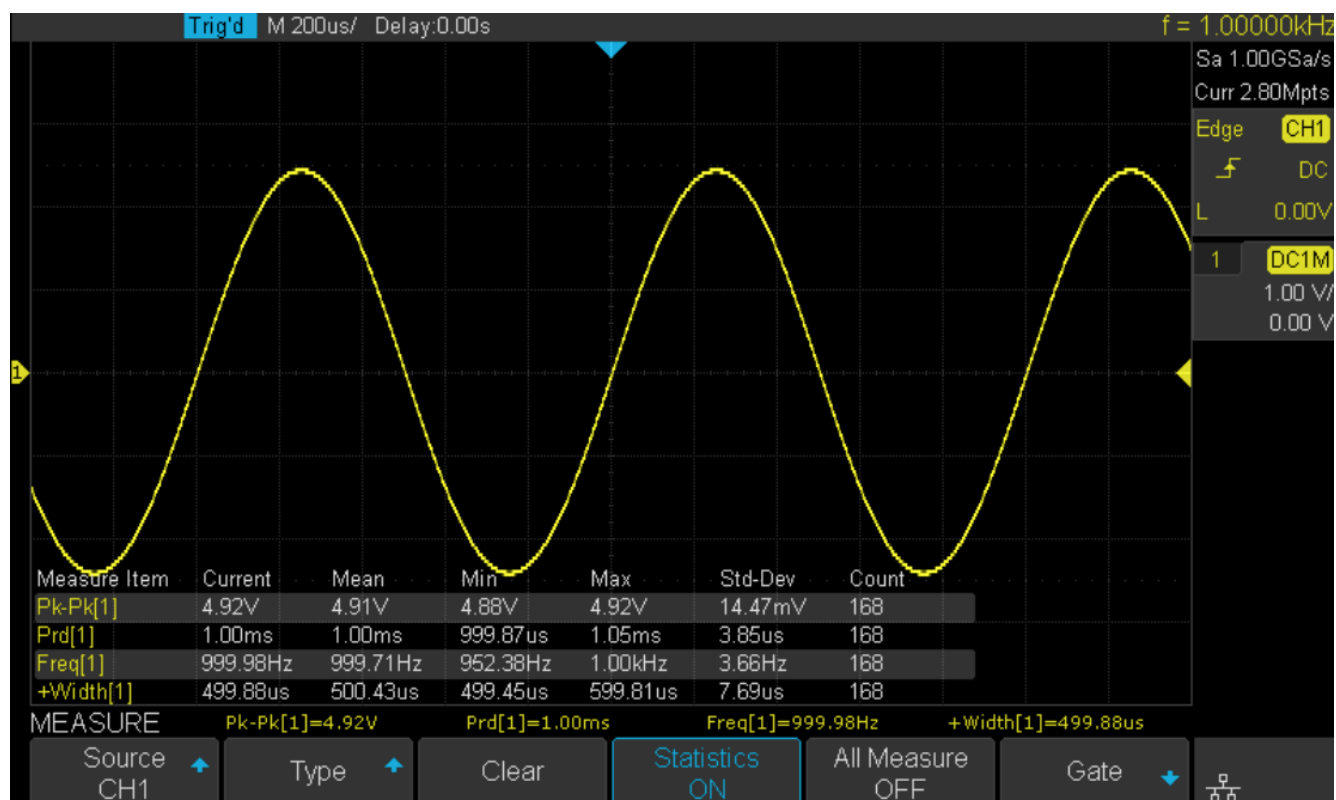

Figure 11.6 New Measurement

Note:

If the parameter does not match the measure condition, it will display as “****”

11.3 All Measurement

All measurement could measure all the voltage, time and delay parameters of the current measurement source and display the results on the screen.

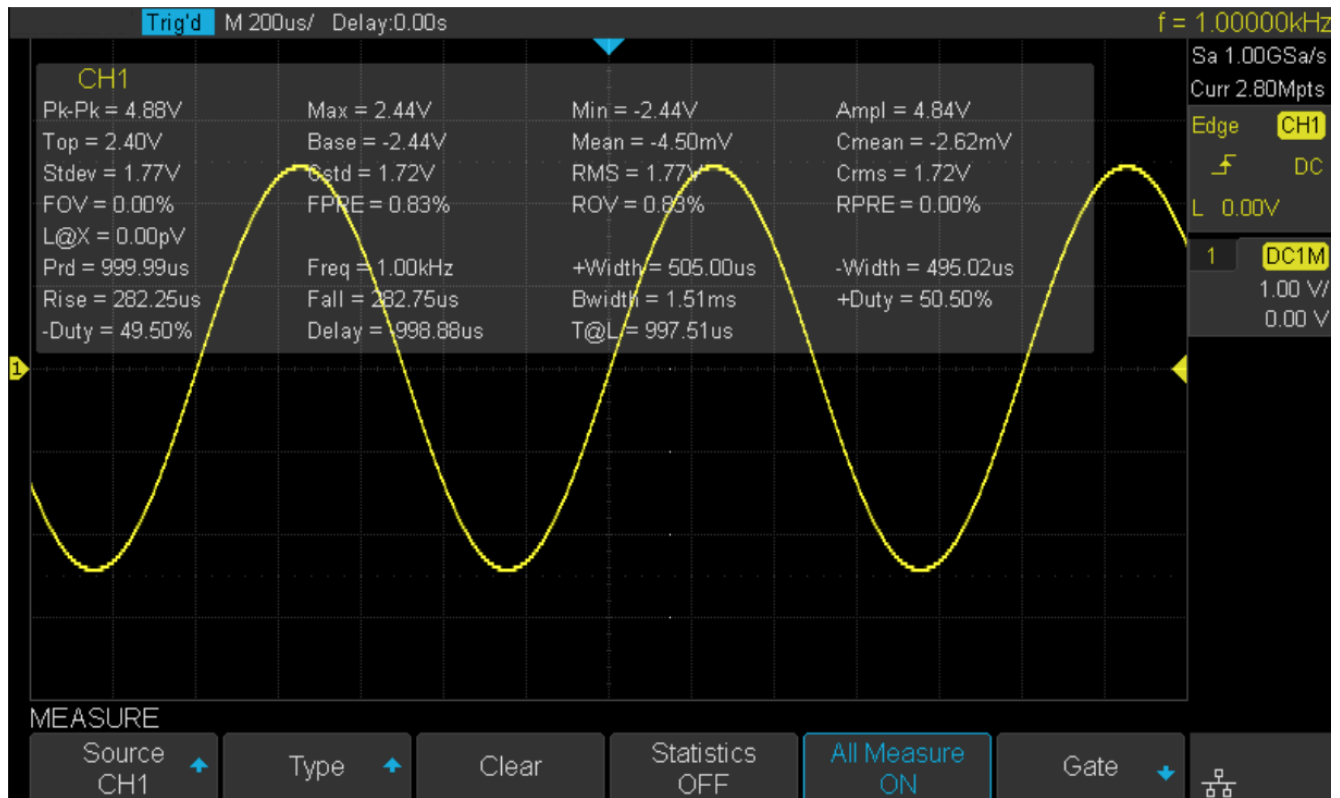

Figure 11.7 All Parameters

To display all parameters:

1. Press the **Measure** key on the front panel to enter the MEASURE function menu.
2. Press the **All Measure** softkey to select On.
3. Press the **Source** softkey to select the measure source.

11.4 Gate Measurement

The 2194 supports gate measurements and performs the selected measurement within the upper and lower limits of the gate. Setting the gate will affect the measurement of all voltage, time, and delay parameters.

1. Press **Measure** → **Gate** → **On** to open the gate measurement.
2. Press the **Gate A** softkey to move the position of gate A by the **Universal Knob**.
3. Press the **Gate B** softkey to move the position of gate B by the **Universal Knob**.
4. Press the **Gate A-B** to move the positions of the gate A and B simultaneously by the **Universal Knob**.

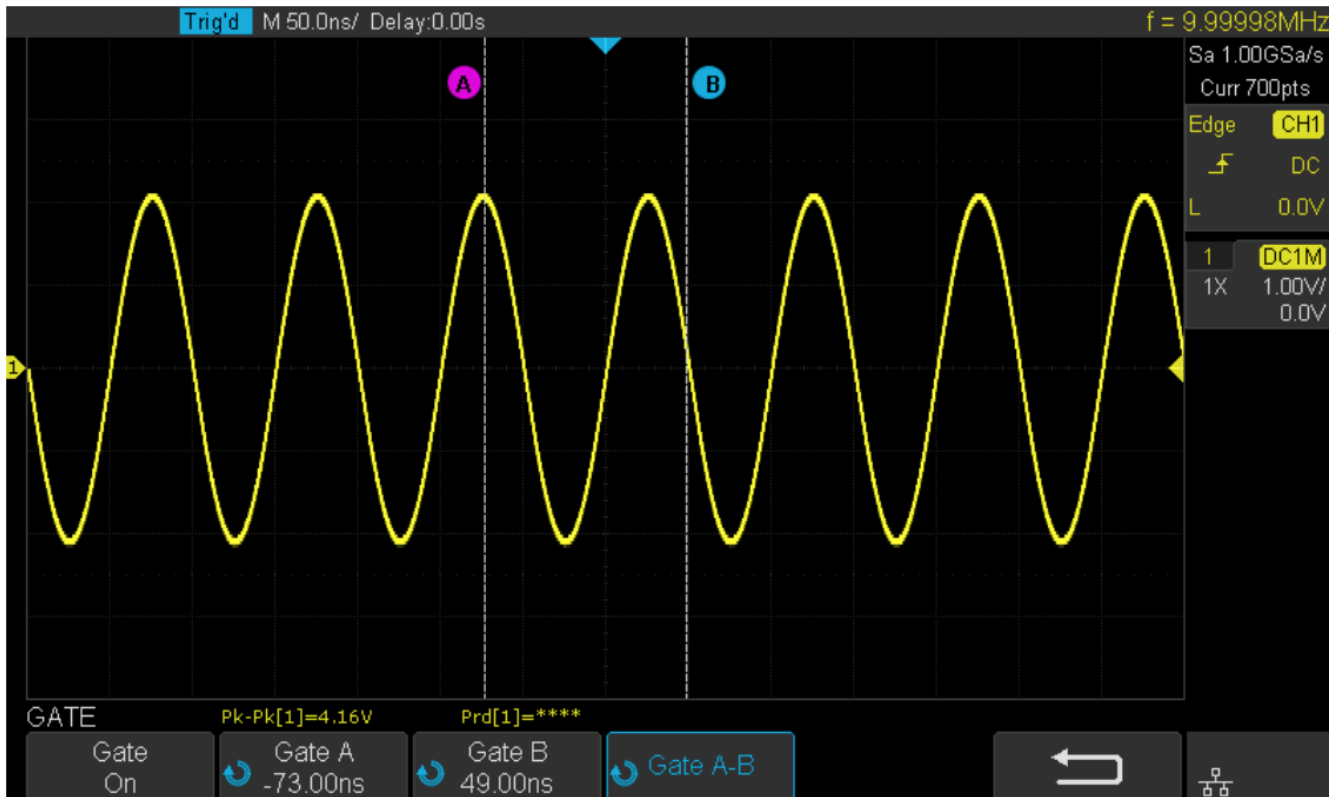

Figure 11.8 Gate Measurement

11.5 Clear Measurement

Press the **Clear** softkey to clear all the measurement parameters that are displaying on the screen.

Display

The display type, color, persistence, grid type, waveform intensity, grid brightness and transparency can be configured.

12.1 Display Type

Press the **Display** key on the front panel, then press the **Type** softkey to select **Vectors** or **Dots** display type.

- **Vectors**: the sample points are connected by lines and displayed. Normally, this mode can provide the most vivid waveform to view the steep edge of the waveform (such as square waveform).
- **Dots**: display the sample points directly. You can directly view each sample point and use the cursor to measure the X and Y values of the sample point.

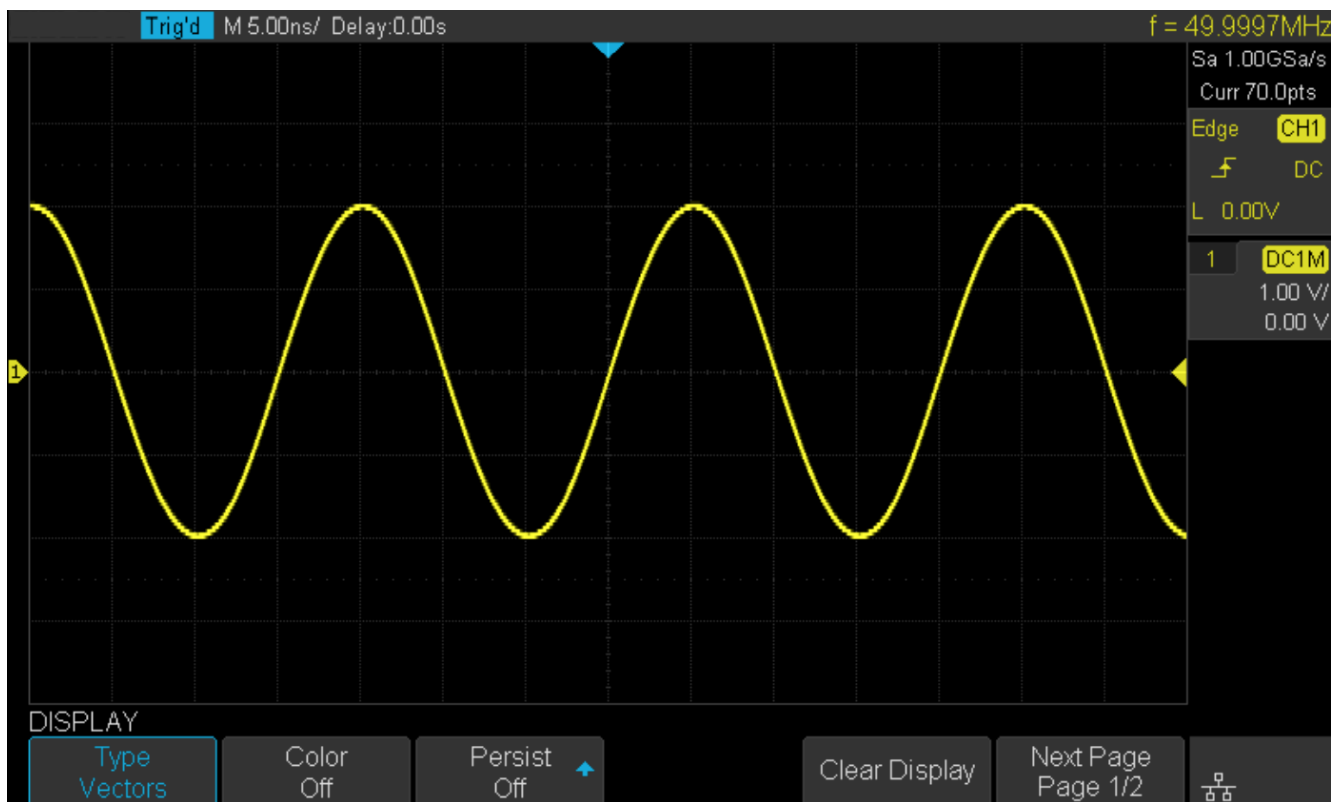

Figure 12.1 Vector Display

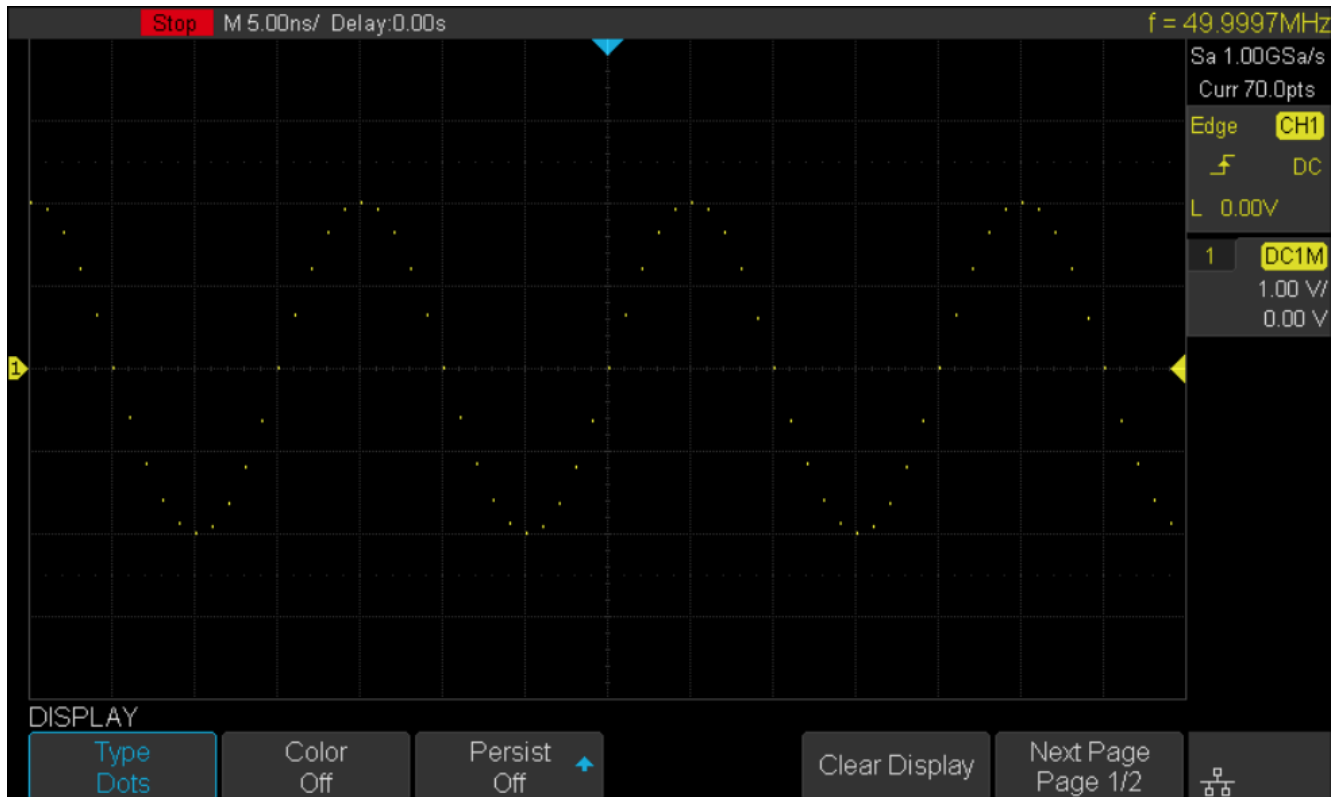

Figure 12.2 Dots Display

12.2 Color Display

Color temperature adopts the change of waveforms' color to reflect the change of the waveforms' appearing probability. The greater the probability that the waveform appears, the warmer the color is; the smaller the waveform appears, the colder the color is.

The picture below shows the change of color from cold to warm. Press the **Display** key on the front panel, and then press the **Color** softkey and set the option to On to turn on the color temperature function. You can compare the waveform's color with the picture below to just the probability that the waveform appears.

Cold Color
→
 Warm Color

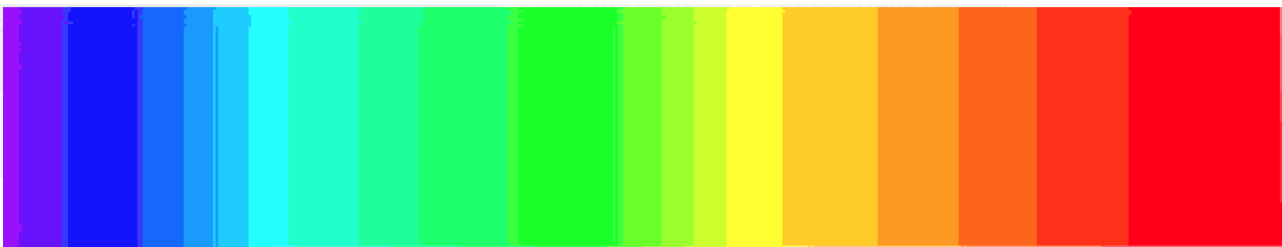

Figure 12.3 Color Temperature

12.3 Persistence

With persistence, the oscilloscope updates the display with new acquisitions, but does not immediately erase the results of previous acquisitions. All previous acquisitions are displayed with reduced intensity. New acquisitions are shown in their normal color with normal intensity.

To set and clear persistence:

1. Press the **Display/Persist** key on the front panel to enter the DISPLAY function menu.
2. Press the **Persist** softkey; then turn the **Universal Knob** to select the desired option.
 - **Off** — Turn off persistence.
 - **Variable persistence time** - Select different persistence time, the results of previous acquisitions are erased after a certain amount of time. (1 second, 5 seconds, 10 seconds, 30 seconds)
 - **Infinite** — Select “Infinite” Results of previous acquisitions are never erased. Use infinite persistence to measure noise and jitter, to see the worst- case extremes of varying waveforms, to look for timing violations, or to capture events that occur infrequently.



Figure 12.4 Persist Set to Infinite

- When **Persist** is **On**, to erase the results of previous acquisitions from the display, press the **Clear Persist** softkey. The oscilloscope will start to accumulate acquisitions again.
- To return to the normal display mode, turn off persist and the previous acquisitions will be clear at once.

12.4 Clear Display

Press the **Display** key on the front panel to enter the DISPLAY function menu; press the **Clear Display** softkey to clear all the waveforms displaying on the screen and acquire and display new waveforms.

12.5 Grid Type

To select a grid type:

1. Press the **Display/Persist** key on the front panel to enter the DISPLAY function menu.
2. Press the **Next Page** softkey to go to the second page of the Display function menu.
3. Press the **Grid** softkey; and then turn the **Universal Knob** to select the desired grid type. Press the Grid softkey continually can also select the grid type.

There are 3 kinds of grid types that are available. Select the grid type according to your really demand.



Display 14X8 grid type



Display 2X2 grid type



Display without grid

12.6 Intensity

To adjust waveform intensity:

1. Press the **Display/Persist** button on the front panel to enter the DISPLAY function menu.
2. Press the **Next Page** softkey to go to the second page of the Display function menu.
3. Press the **Intensity** softkey; and then turn the **Universal Knob** to select the desired value. The default value is 50%, and the range is from 0% to 100%.

Increasing the intensity lets you see the maximum amount of noise and infrequently occurring events. Reducing the intensity can expose more detail in complex signals as shown in the following figures.

Note:

Waveform intensity adjustment affects analog channel waveforms only (not math waveforms, reference waveforms, digital waveforms, etc.).

12.7 Grid Brightness

To adjust the grid brightness:

1. Press the **Display** button on the front panel to enter the DISPLAY function menu.
2. Press the **Next Page** softkey to go to the second page of the Display function menu.
3. Press the **Graticule** softkey; and then turn the **Universal Knob** to select the desired value. The default value is 40%, and the range is from 0% to 100%.

12.8 Transparency

Transparence can be used to adjust the transparence of the message box of cursor, measure, Pass/Fail and all pop-up menus to an appropriate value to observe the date more conveniently.

Under Cursor or Measure or any other menu operation, if want to change the transparence of the message box, do the following steps:

1. Press the **Display** button on the front panel to enter the DISPLAY function menu.
2. Press the **Next Page** softkey to go to the second page of the Display function menu.
3. Press the **Transparence** softkey; and then turn the **Universal Knob** to select the desired value. The default value is 80%, and the range is from 20% to 80%.

Save and Recall

Oscilloscope setups, waveforms, pictures, and CSV files can be saved to internal oscilloscope memory or to a USB storage device. The saved setups, waveforms can be recalled later. The oscilloscope provides a USB Host interface on the front panel to connect an USB device for external storage.

13.1 Save Type

The oscilloscope supports setups, waveforms, pictures and CSV files storage. The default save type is setups.

1. **Setups**

It's the default storage type of the oscilloscope. It saves the settings of the oscilloscope in internal or external memory in "*.SET" format. At most 20 setting files (from No.1No.20) can be stored in internal memory. The stored settings can be recalled.

2. **Reference**

The oscilloscope saves the waveform data in external memory in "*.REF" format. The data of the channel is you select channel. At recall, the data will be displayed on the screen by REFA or REFB.

3. **BMP**

The oscilloscope saves the screen image in external memory in "*.bmp" format. You can specify the file name and saving directory under the same directory using the same file name. The recall of image is not supported.

4. **JPG**

The oscilloscope saves the screen image in external memory in "*.jpg" format. You can specify the file name and saving directory under the same directory using the same file name. The recall of image is not supported.

5. **PNG**

The oscilloscope saves the screen image in external memory in "*.png" format. You can specify the file name and saving directory under the same directory using the same file name. The recall of image is not supported.

6. **Binary**

The oscilloscope saves the waveform data in external memory in "*.BIN" format. The data of all the channels turned on can be saved in the same file. The recall of binary is not supported.

7. **CSV**

The oscilloscope saves the waveform data in external memory in "*.CSV" format. The stored files contain the waveform data of the displayed analog channels and the main setting information of the oscilloscope. The recall of CSV file is not supported.

Set the save type to CSV, and set the Para Save option to On or Off to turn on or of the parameters storage function.

8. **Matlab**

The oscilloscope saves the waveform data in external memory in "*.DAT" format. The data of all the channels turned on can be saved in the same file. The recall of Matlab file is not supported.

9. **To Default Key**

The oscilloscope saves the factory config and user set config. Then you can select the default function is the factory config or user set config.

10. **Bin2CSV Tool**

Download the tool and run it after decompressing on PC. The bin file of waveform data can be converted into a visual CSV file.

13.2 Internal Save and Recall

Internal save and recall support Setups in **Save/Recall**. In the following part, the save and recall method and procedures are introduced.

Save the specified oscilloscope setting in internal memory.

1. Connect the signal to the oscilloscope and obtain stable display.
2. Press **Save/Recall** key on the front panel to enter the SAVE/RECALL function menu.
3. Press the **Save** softkey to enter the SAVE function menu.
4. Press the **Type** softkey and then turn the **Universal Knob** to select **Setups**; and then press the knob to confirm.
5. Press the **Save To** softkey to select **Internal** to save the current setup of the oscilloscope to the internal memory.
6. Press the **Setup** softkey button; and then turn the **Universal Knob** to select the location to save. The internal memory can save as many as 20 setup files, from No.1No.20.
7. Press the **Press To Save** softkey to save the current setup to the appointed location. After a few seconds, it will pop-up the message "**Saved to internal file NO.1!**"

Load the specified type of file in internal memory.

To recall the setup after having finished the steps above, please do the following steps:

1. Press the **Recall** softkey enter the RECALLING function menu.
2. Press **Type** softkey and then turn the **Universal Knob** to select Setups; and then press the knob to confirm.
3. Press the **Recall** from softkey to select Internal.
4. Press **Setup** softkey button; and then turn the **Universal Knob** to select the location to recall. The internal memory can recall as many as 20 setup files, from No.1No.20.
5. Press the **Press To Recall** softkey to recall the current setup form the appointed location. After a few seconds, it will pop-up the message "**Recalled file successfully!**"

Note:

If need to delete a setup file in the memory, please save a new setup to the same location to overwrite it.

13.3 External Save and Recall

Before using external storage and recall, a USB flash device must be connected correctly. External storage supports all the types of files in save, but picture and CSV are not supported when recalling.

Save the specified type of file in the external USB flash device.

1. Press the **Save/Recall** key on the front panel to enter the SAVE/RECALL function menu.
2. Press the **Save** softkey to enter the SAVE menu.
3. Press the **Type** softkey to select **Setup** and then press the knob to confirm.
4. Press the **Press To Save** softkey to enter the SAVE/RECALL file system.

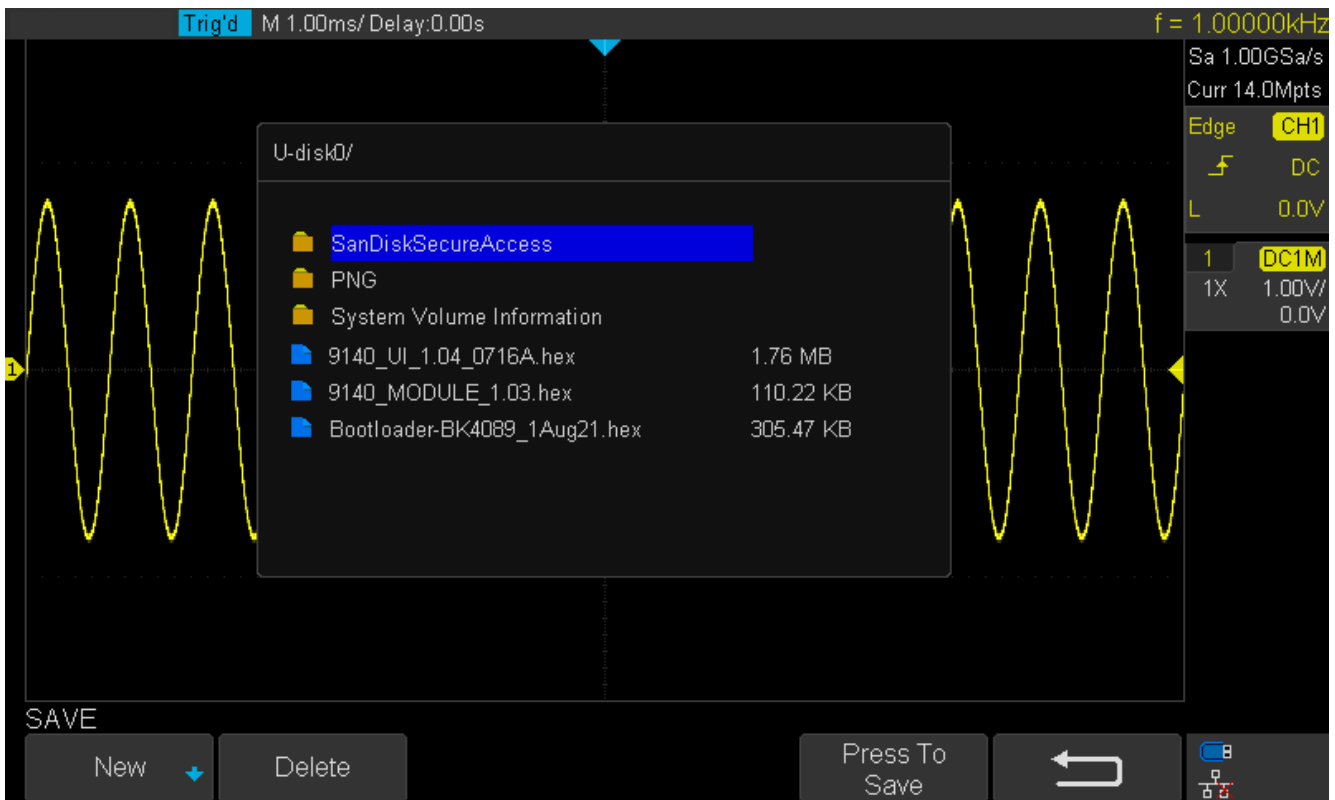

Figure 13.1 SAVE/RECALL File System

5. Use the **Universal Knob** to select the desired location. File can be stored under the root directory or in a certain folder under the root directory of the USB storage device.

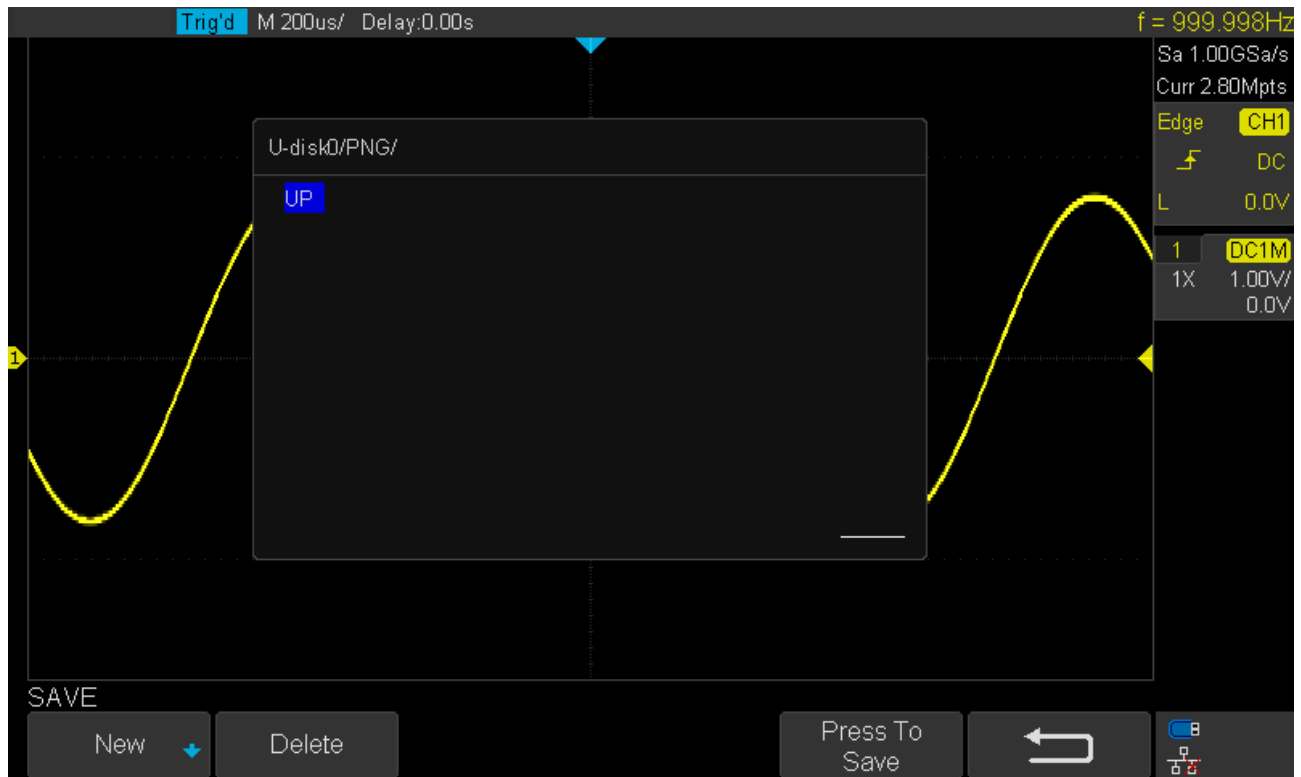

Figure 13.2 Select Save Location

- After the save position is selected, press the **New** softkey to turn on the interface as shown in the figure below. Refer to the descriptions in “**To Create a new file or fold**” to create a new file name.

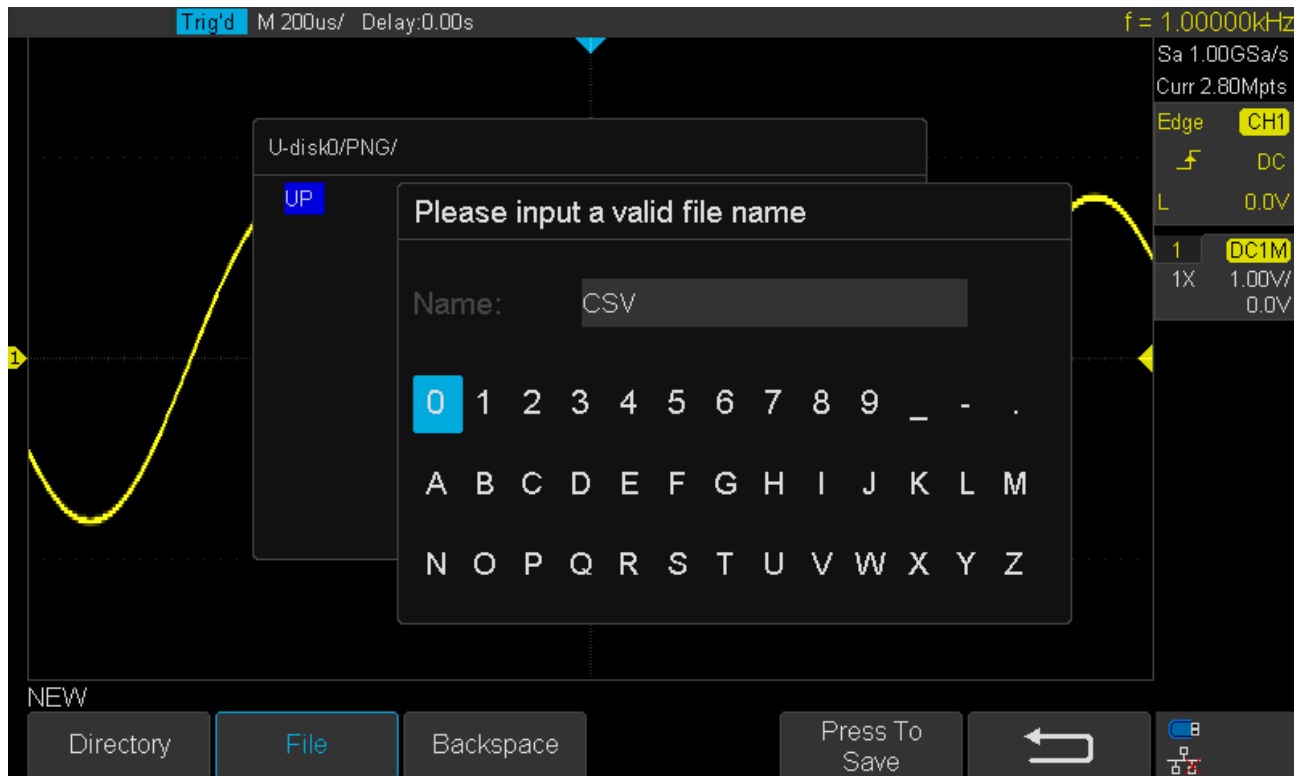

Figure 13.3 File Name

- Press the **Press To Save** softkey to save the current setup to the external USB storage device.

Load the specified type of file in the external USB storage device.

1. Press the **Save/Recall** key on the front panel to enter the SAVE/RECALL function menu.
2. Press the **Recall** softkey to enter the RECALL menu.
3. Press the **Type** softkey to select **Setup** or **Waveform**.
4. Press the **Recall** from softkey to select External.
5. Press the **Press To Recall** softkey to enter the SAVE/RECALL file system.
6. Turn the **Universal Knob** to select the file to be recalled, press the **Press To Recall** softkey to recall the waveform or setup.

13.4 Disk Management

Disk management aim at the save and recall operations after the oscilloscope is connected with a USB storage device. Before using an external disk, make sure that the USB storage device is connected correctly.

13.4.1 Create a New File or Folder

This operation is only valid in external storage. The oscilloscope supports English input method. The file name or folder name can contain letters, numbers, underscores and spaces.

Example Create a file or folder named “CSV”

1. Press the **Save/Recall** key on the front to enter the SAVE/RECALL function menu.
2. Press the **Save** softkey, and then turn the Universal Knob to select one of the type (if select Setups, please set the Save To option to External).
3. Press the **Press to Save** softkey to enter the SAVE/RECAL file system.
4. Press the **New** softkey to open the interface shown as the picture below. It divides into two parts: name input area and keyboard area.



Figure 13.4 Input Keyboard

5. To delete the name in the name input area, press the **Backspace** softkey continuously to delete the character one by one.

13.4.2 Delete a File or Folder

This operation is only valid in external storage.

1. Press the **Save/Recall** key on the front to enter the SAVE/RECALL function menu.
2. Press the **Save** softkey, and then turn the Universal Knob to select one of the type (if select Setups, please set the Save To option to External).
3. Press the **Press to Save** or **Press to Recall** softkey to enter the SAVE/RECAL file system.
4. Turn the **Universal Knob** to select the file or folder to be deleted, and then press the **Delete** softkey. Then the file or folder will be deleted.

13.4.3 Rename a File or Folder

This operation is only valid with external storage (U disk storage), and only files of the corresponding type format can be renamed.

1. Press the **Save/Recall** key on the front to enter the SAVE/RECALL function menu.
2. Press the **Save** softkey, and then turn the **Universal Knob** to select one of the type (if select Setups, please set the **Save To** option to **External**).
3. Press the **Press To Save** or **Press To Recall** softkey to enter the SAVE/RECAL file system.
4. Turn the **Universal Knob** to select the file or folder to be rename, and then press the **Rename** softkey. For details, see the instructions in "Create a New File or Folder."

System Settings

This function module supports the oscilloscope's system-related function, such as system status, language, sound and some other advanced setting, such as do self-cal, update and remote interface configure.

14.1 View System Status

To view the system status:

1. Press the **Utility** key on the front to enter the UTILITY function menu.
2. Press the **System Status** softkey to view the system status of the oscilloscope. The system status includes the information below:
 - *Startup Times*: record the boot-strap times of the oscilloscope.
 - *Software Version*: list the current software version of the oscilloscope.
 - *Uboot-OS Version*: list the current Uboot and OS version of the oscilloscope
 - *FPGA Version*: list the current fpga version of the oscilloscope.
 - *Hardware Version*: list the current hardware version of the oscilloscope.
 - *Product Type*: display the product type of the oscilloscope.
 - *Serial NO.*: list the serial number of the oscilloscope.

```
Startup Times:
    482
Software Version:
    6.1.32
Uboot-OS Version:
    7.0
FPGA Version:
    2019-04-08
Hardware Version:
    00-02
Product Type:
    BK 2194
Serial No.:
    SDSMM123456QQQ
```

Press 'Single' key to exit.

Figure 14.1 System Status

3. Press the **Single** key on the front panel to exit.

14.2 Self Cal

The self-calibration program can quickly make the oscilloscope reach the best working state to get the most precise measurement values. You can perform self-calibration at any time especially when the change of the environment temperature is up to more than 5 °C. make sure that the oscilloscope has been warmed up or operated for more than 30 minutes before the self-calibration.

To perform a self-calibration :

1. Disconnect all the input channels.
2. Press the **Utility** key on the front panel, and then press the **Do Self Cal** softkey, and the oscilloscope will pop-out the message shown in figure ??.

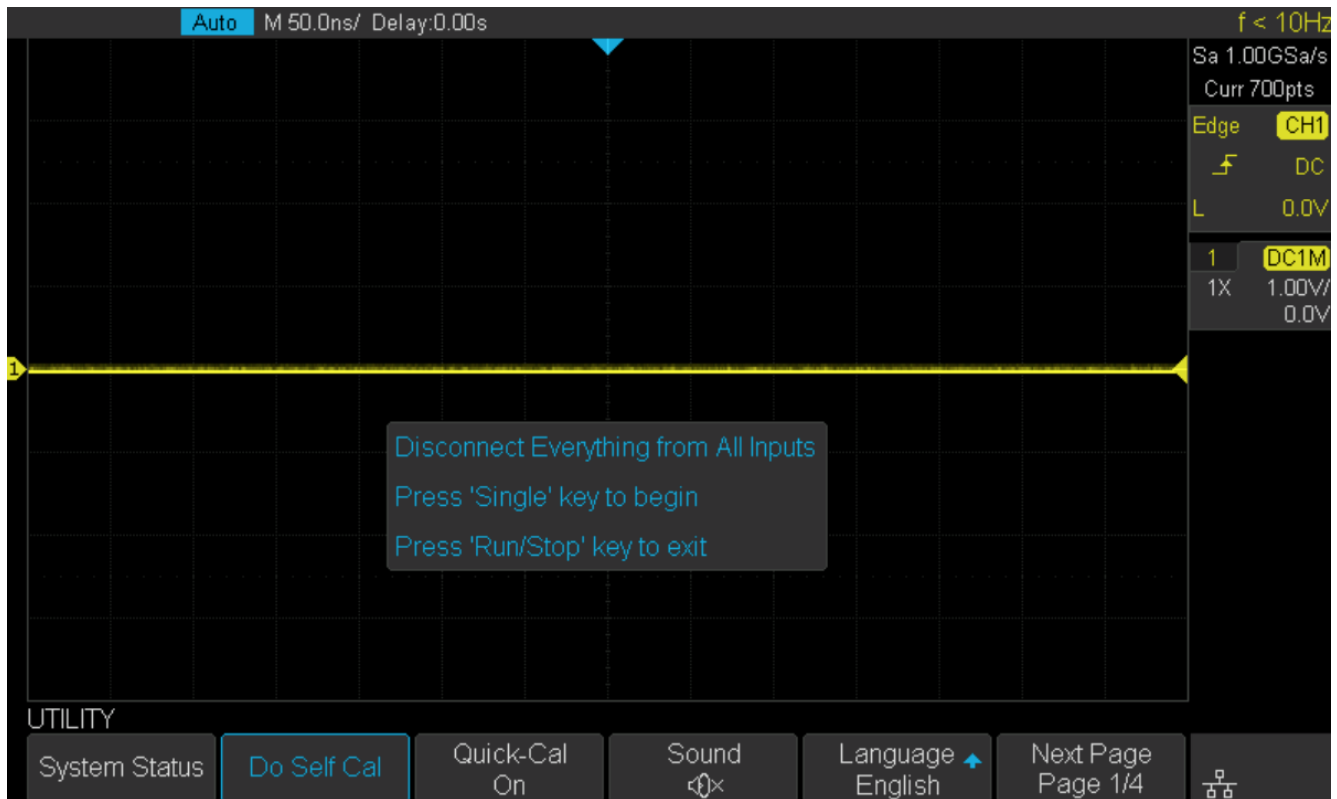

Figure 14.2 Self Cal

3. Press the **Single** key on the front panel to perform the self-calibration program. During the calibration, most of the keys are disabled.
4. When the self-calibration program is finished, it will pop-out the message “**press Run/Stop key to exit**”. Press the **Run/Stop** button on the front panel to exit the calibration interface.



14.3 Quick-Cal

Quick calibration can correct the measurement deviation caused by temperature, so that you can get more accurate measurements.

If the ambient temperature of your current operating oscilloscope is unstable, press **Utility** → **Quick-Cal** softkey to select **On** to enable quick calibration.

14.4 Sound

When the sound is enabled, you can hear the sound of the beeper when you press a function key or a menu softkey or when the prompt message pops up.

Press the **Utility** key on the front panel to enter the UTILITY function menu; then press **Sound** softkey to select  or  to turn on or off the sound.

14.5 Language

The oscilloscope supports multiple language menu, Chinese/English help and prompt messages.

1. Press **Utility** key on the front panel to enter the UTILITY Function menu.
2. Press the **Language** softkey; and then turn the **Universal Knob** to select the desired language. Then push down the knob to select the language.

The languages that currently available are Simplified Chinese, Traditional Chinese, English, French, German, Spanish, Russian, Italian, and Portuguese.

14.6 Pass/Fail Test

One way to verify a waveform's compliance to a particular set of parameters is to use pass/fail testing. A pass/fail defines a region of the oscilloscope's display in which the waveform must remain in order to comply with chosen parameters. Compliance to the mask is verified point-by-point across the display.

The test results can be displayed on the screen as well as be declared through the system sound or the pulse signal output from the [TRIG OUT] connector at the rear panel. Pass/Fail test operates on displayed analog channels; it does not operate on channels that are not displayed.

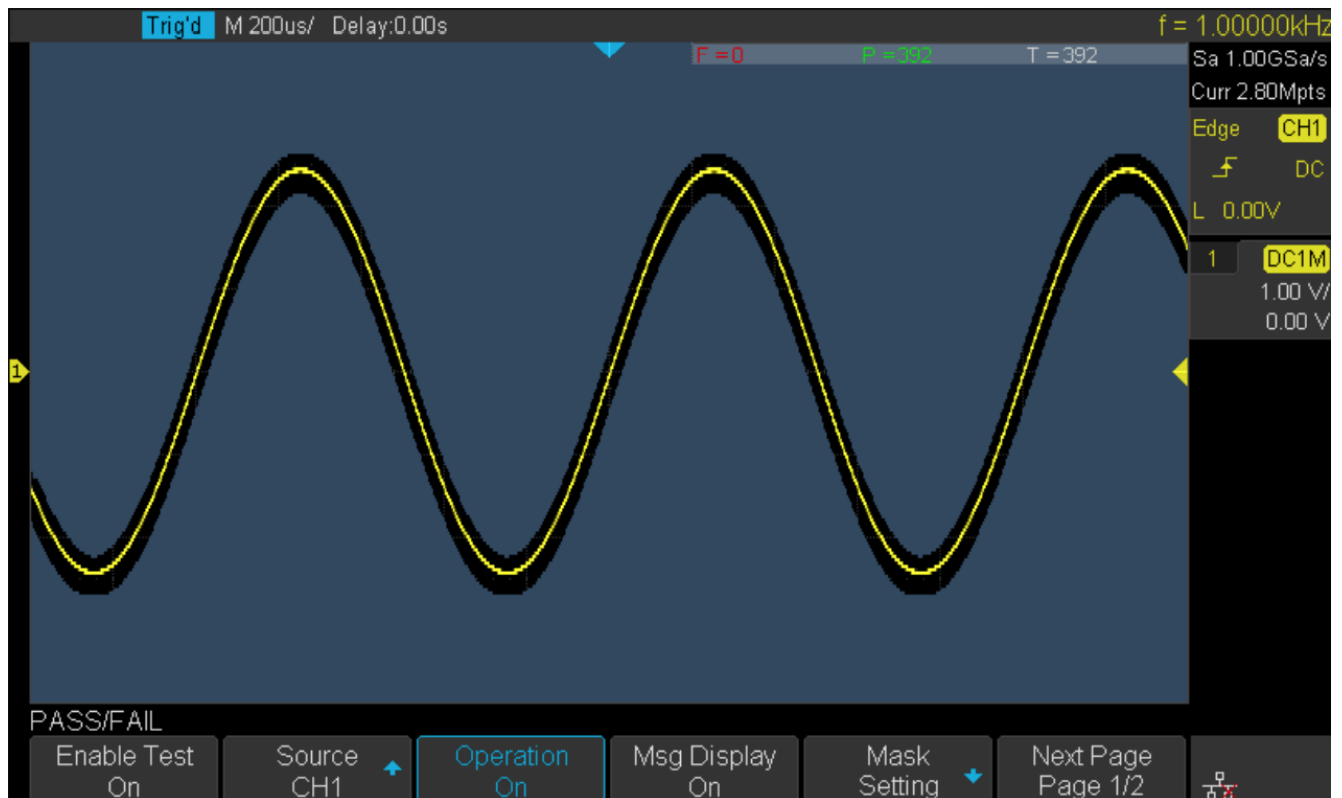





Figure 14.3 Pass Fail Test

14.6.1 Set and Perform a Pass/Fail Test

To set and perform pass/fail test:

1. Press the **Utility** key on the front panel to enter the UTILITY function menu.
2. Press the **Next Page** softkey to go to the second page of the UTILITY function menu.
3. Press the **Pass/Fail** softkey to enter the PASS/FAIL function menu.
4. Press the **Enable Test** softkey to select On to enable the pass/ fail test.
5. Press the **Source** softkey to select the desired channel.
6. Press the **Mask Setting** softkey to enter the MASK function menu.
7. Press the **X Mask** or **Y Mask** softkey; and then turn the **Universal Knob** to select the desired value. The range is from 0.02div to 4div.
8. Press the **Create Mask** softkey to create the mask. Whenever the **Create Mask** softkey is pressed the old mask is erased and a new mask is created.
9. Press the **UP** softkey to return to the PASS/FAIL function menu.
10. Press the **Msg Display** to select **On** or **Off** to turn on or off the message display. When On is selected, the test result will be displayed in the upper-right message box of the screen.

The screenshot shows a dark grey rectangular box with three pieces of information: 'F = 271' in red text, 'P = 304' in green text, and 'T = 615' in white text.

- \underline{F} : the frame number of the channel waveform that fails to match the mask.
 - \underline{P} : the frame number of the channel waveform that matches the mask.
 - \underline{T} : the frame number of the channel waveform that have been acquired. It is the total of **Pass** and **Fail**.
11. Press the **Next Page** softkey to go to the second page of the PASS/FAIL function menu.
 12. Press the **Stop On Fail** softkey to select **On** or **Off** to turn on or off the function.
 - **On**: when failed waveforms are detected, the oscilloscope will stop the test and enter the STOP state. At this point, the results of the test remain the same on the screen (if display is turned on) and only one pulse is output from the **[TRIG OUT]** connector (if enabled) at the rear panel.
 - **Off**: the oscilloscope will continue with the test even though failed waveforms are detected. The test results on the screen will update continuously and a pulse will be output from the **[Trigger Out]** connector at the rear panel each time a failed waveform is detected.
 13. Press the **Output** softkey to select turn on or off the sound.
 -  : When the failed waveforms are detected, the beeper sounds.
 -  : The beeper will not sound even if the failed waveforms are detected,
 14. Press the Next Page softkey to return to the first page of the PASS/FAIL function menu.
 15. Press the Operate softkey to perform the test.
 -  : Current state is stop; press the softkey to start the pass/fail test.
 -  : Current state is running; press the softkey to stop the pass/fail test.

14.6.2 Save and Recall Test Mask

The current test mask can be saved to the internal Flash memory or external USB flash device. the file format of the test mask file is "*.msk".

Save Test Mask to Internal Memory

1. Press the **Utility** key on the front panel to enter the UTILITY function menu.
2. Press the **Next Page** softkey to go to the second page of the UTILITY function menu.
3. Press the **Pass/Fail** softkey to enter the PASS/FAIL function menu.
4. Press the **Enable Test** softkey to select **On** to enable the pass/ fail test.
5. Press the **Source** softkey to select the desired channel.
6. Press the **Mask Setting** softkey to enter the MASK function menu.
7. Press the **X Mask** or **Y Mask** softkey; and then turn the **Universal Knob** to select the desired value.
8. Press the **Location** softkey to select Internal
9. Press the **Save** softkey to save the mask to internal memory.
10. A few second later, it will pop-out the message "**Save to file Pass/Fail_mask_data.msk!**"

Note:

The internal memory can only saver one test mask; save a new test mask will cover the old one.

Recall Test Mask from Internal Memory

1. Press the **Utility** key on the front panel to enter the UTILITY function menu.
2. Press the **Next Page** softkey to go to the second page of the UTILITY function menu.
3. Press the **Pass/Fail** softkey to enter the PASS/FAIL function menu.
4. Press the **Enable Test** softkey to select **On** to enable the pass/ fail test.
5. Press the **Mask Setting** softkey to enter the MASK function menu.
6. Press the **Location** softkey to select **Internal**.
7. Press the **Load** softkey to recall the saved interval memory.
8. A few second later, it will pop-out the message "**Recalled the Successfully!**" and the saved mask will be displayed on the screen.

Save Test Mask to External Memory

To save the test mask to external memory:

1. Press the **Utility** key on the front panel to enter the UTILITY function menu.
2. Press the **Next Page** softkey to go to the second page of the UTILITY function menu.
3. Press the **Pass/Fail** softkey to enter the PASS/FAIL function menu.
4. Press the **Enable Test** softkey to select On to enable the pass/ fail test.
5. Press the **Source** softkey to select the desired channel.
6. Press the **Mask Setting** softkey to enter the MASK function menu.
7. Press the **X Mask** or **Y Mask** softkey; and then turn the **Universal Knob** to select the desired value.
8. Press the **Location** softkey to select **External**.
9. Press the **Save** softkey to enter the file SAVE/RECALL system.
10. Save the test mask file refer to the “**Save to file XXX.msk**” chapter.

Recall Test Mask from External Memory

To save the test mask f external memory:

1. Press the **Utility** key on the front panel to enter the UTILITY function menu.
2. Press the **Next Page** softkey to go to the second page of the UTILITY function menu.
3. Press the **Pass/Fail** softkey to enter the PASS/FAIL function menu.
4. Press the **Enable Test** softkey to select **On** to enable the pass/ fail test.
5. Press the **Mask Setting** softkey to enter the MASK function menu.
6. Press the **Location** softkey to select **External**.
7. Press the **Load** softkey to enter the file SAVE/RECALL system.
8. Select the desired test mask file with a RGU postfix using the **Universal Knob**; and then press the **Load** softkey.

14.7 IO Set

The oscilloscope provides the following input output interfaces: USB, LAN, and Auc Output.

14.7.1 LAN

To set the oscilloscope to communicate with PC via LAN:

1. Connect the oscilloscope to your local area network using the network cable.
2. Press the **Utility** button on the front panel to enter the UTILITY function menu.
3. Press the **IO Set** softkey to enter the I/O SET function menu.
4. Press the **Net Interface LAN** softkey to select LAN.
5. Press the **IP Set** softkey to enter the IP setting interface, see figure 14.4.
6. Press the DHCP softkey to turn on or turn off the DHCP.

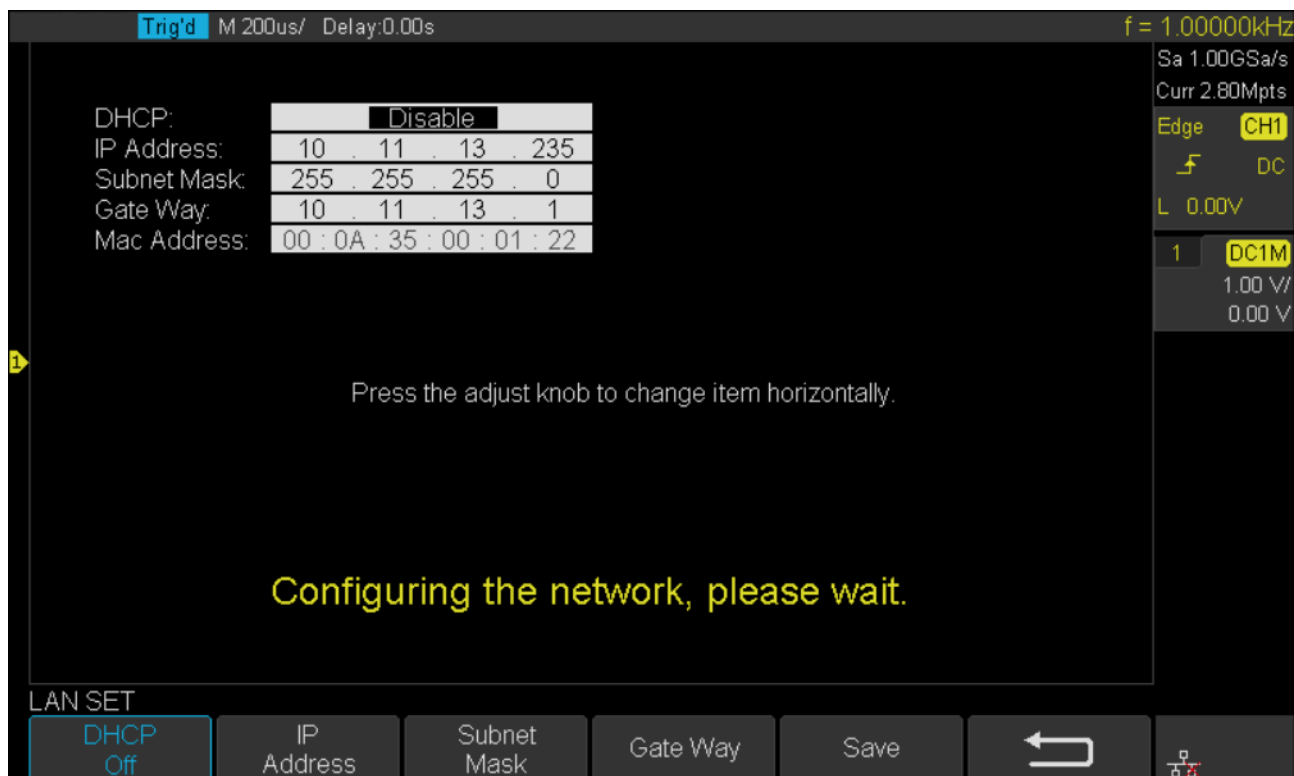

Figure 14.4 IP Set

- On: the DHCP server in the current network will assign the network parameters (such as the IP address) for the oscilloscope.
- Off: you can set the IP address, subnet mask, gate way manually.
 - Turn the **Universal Knob** to select the desired value.
 - Push the **Universal Knob** to change item horizontally.
 - Press the **Save** softkey to save the current setting.

14.7.2 USB Device

To set the oscilloscope to communicate with a PC via USB:

1. Install the USBTMC device driver on PC. Suggest you install NI Vista.
2. Connect the oscilloscope with PC using a standard USB cable
3. Press the **Utility** key on the front panel to enter the UTILITY function menu.
4. Press the **IO Set** softkey to enter the I/O SET function menu.
5. Press the **USB Device** softkey to select **USBTMC**.

14.8 Update Firmware and Configuration

The firmware and configuration can be updated directly via USB flash driver.

To update the firmware:

1. Insert the USB flash driver which with the firmware and the configure files inside into the USB host interface on the front panel of the oscilloscope.
2. Press the **Utility** key on the front panel to enter the UTILITY function menu.
3. Press the **Next Page** softkey to go to the second page of the UTILITY function menu.
4. Press the **Next Page** softkey to go to the third page of the UTILITY function menu.
5. Press the **Update** softkey to enter the UPDATE function menu.
6. Press the **Firmware** softkey to open the file manager.
7. Turn the **Universal Knob** to select the update file which should be with an ADS postfix; and then press the **Press to Update** softkey to start update the firmware. The process needs about 7 minutes. And during the update, do not remove power to the oscilloscope, otherwise the oscilloscope may be permanently damaged and may not restart again.
8. After finish the update, the screen will pop-out the message "**Firmware decompressed. Please restart and wait...**".
9. Restart the oscilloscope to finish the firmware update.

To update the configuration:

1. Insert the USB flash driver which with the firmware and the configure files inside into the USB host interface on the front panel of the oscilloscope.
2. Press the **Utility** key on the front panel to enter the UTILITY function menu.
3. Press the **Next Page** softkey to go to the second page of the UTILITY function menu.
4. Press the **Next Page** softkey to go to the third page of the UTILITY function menu.
5. Press the **Update** softkey to enter the UPDATE function menu.
6. Press the **Configure** softkey to open the file manager.
7. Turn the **Universal Knob** to select the update file (*.CFG file extension) and then press the **Press to Update** softkey to start update the firmware. The process needs about 30 seconds.

8. After finish the update, the screen will pop-out the message “**Firmware decompressed. Please restart and wait...**”
9. Restart the oscilloscope to finish the configuration update.

14.9 Do Self-Test

Self-test includes a screen test, keyboard test, and LED test.

14.9.1 Screen Test

1. Press the **Utility** key on the front panel to enter the UTILITY function menu.
2. Press the **Next Page** softkey to go to the second page of the UTILITY function menu.
3. Press the **Next Page** softkey to go to the third page of the UTILITY function.
4. Press the **Do-Self-Test** softkey to enter the SELFTEST function menu.
5. Press the **Screen Test** softkey to enter the screen test interface, as shown in figure [14.5](#)

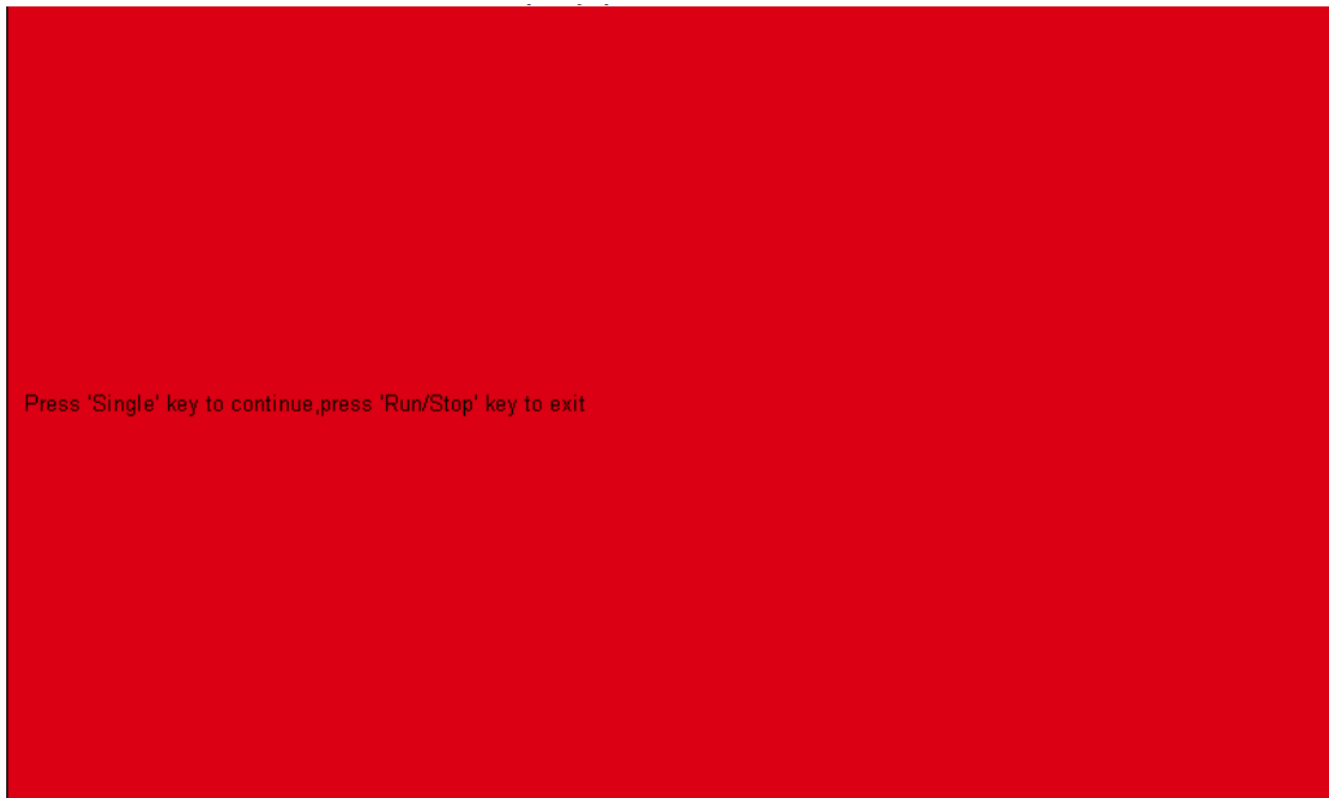

Figure 14.5 Screen Test

6. Press the **Single** key on the front panel continually as it says in the picture above. The screen displays green, blue and red again. It is easy to check chromatic aberration, stain and scratch of the screen under the condition.
7. Press the **Run/Stop** key on the front panel to exit the screen test program.

14.9.2 Keyboard Test

Keyboard test is used to test the keys and knobs. **To perform a keyboard test:**

1. Press the **Utility** key on the front panel to enter the UTILITY function menu.
2. Press the **Next Page** softkey to go to the second page of the UTILITY function menu.
3. Press the **Next Page** softkey to go to the third page of the UTILITY function menu.
4. Press the **Do Self-Test** softkey to enter the SELFTEST function menu.
5. Press the **Keyboard Test** softkey to enter the keyboard test interface, as the picture shown below.

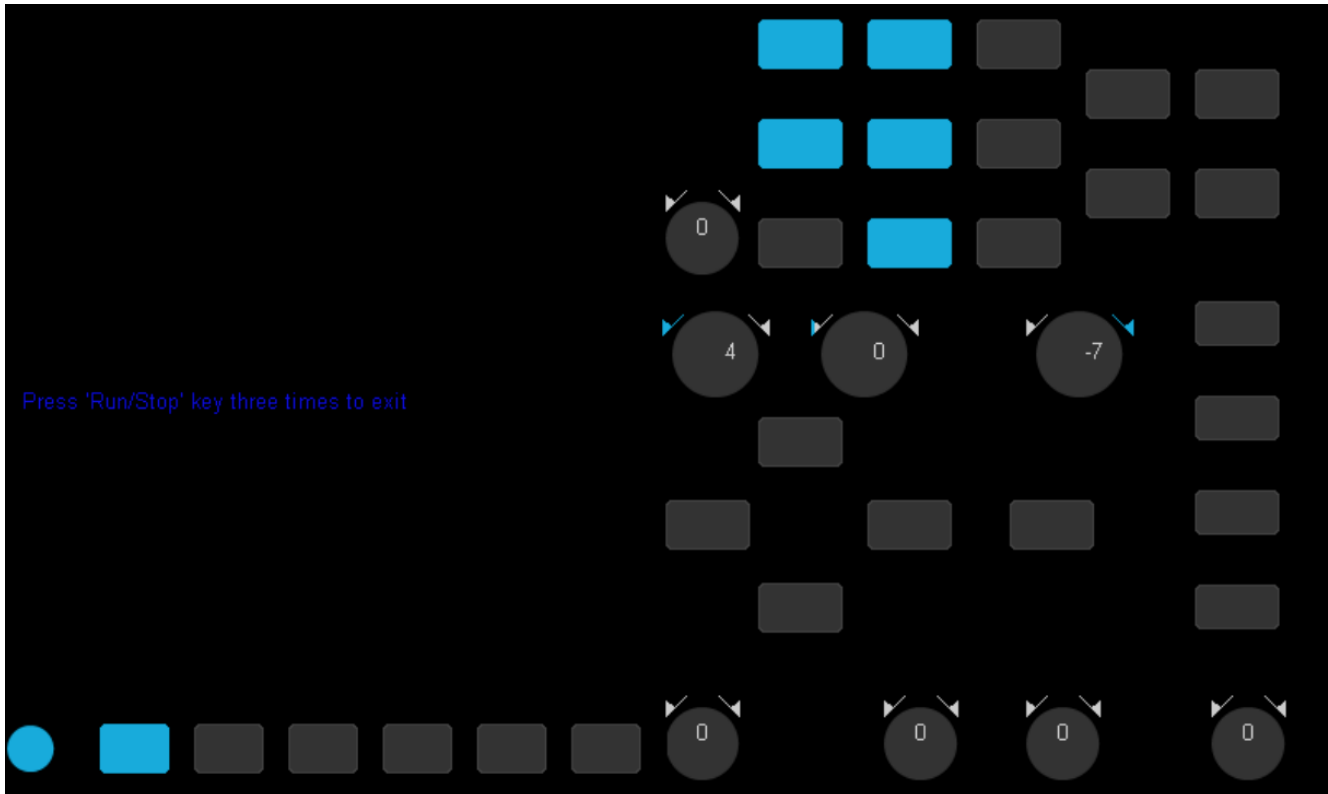

Figure 14.6 Keyboard Test

6. To perform the knobs and the buttons test.
 - *Knobs test:* The default value is 0. Turn left to increase the value while turn right to decrease; push the knob to set the value to 0. Test every knob randomly.
 - *Keys test:* The first time to press the key to light it up, and a second press to die out. Test every button randomly.
7. Press the Run/Stop button 3 times to exit the keyboard test program.

14.9.3 LED Test

LED test is used to test the LEDs.

1. Press the **Utility** key on the front panel to enter the UTILITY function menu.
2. Press the **Next Page** softkey to go to the second page of the UTILITY function menu.
3. Press the **Next Page** softkey to go to the third page of the UTILITY function menu.
4. Press the **Do Self-Test** softkey to enter the SELFTEST function menu.
5. Press the **LED Test** softkey to enter the keyboard test interface, as the picture shown below.



Figure 14.7 LED Test

6. According to the prompting information displaying on the screen, press the **Single** key continually to light the button lights one by one. The first time to press the **Single** key, the **Run/Stop** key displays red, and the second press the **Run/Stop** key displays green. Then the other button lights will be lighted one by one. At last all the lights will be lighted at the same time.
7. Press the **Run/Stop** key to exit the LED test program

14.10 Screen Saver

When the oscilloscope enters the idle state and holds for a certain period of time, the screen saver program will be enabled.

To set the screen saver time:

1. Press the **Utility** key on the front panel to enter the UTILITY function menu.
2. Press the **Next Page** softkey to go to the second page of the UTILITY function menu.
3. Press the **Next Page** softkey to go to the third page of the UTILITY function menu.
4. Press the **Screen Saver** softkey; and then turn the **Universal Knob** to select the desired screen saver time. The screen saver time can be set to **1min, 5min, 10min, 30min, and 1hour**. Also you can select **Off** to turn off the screen saver function

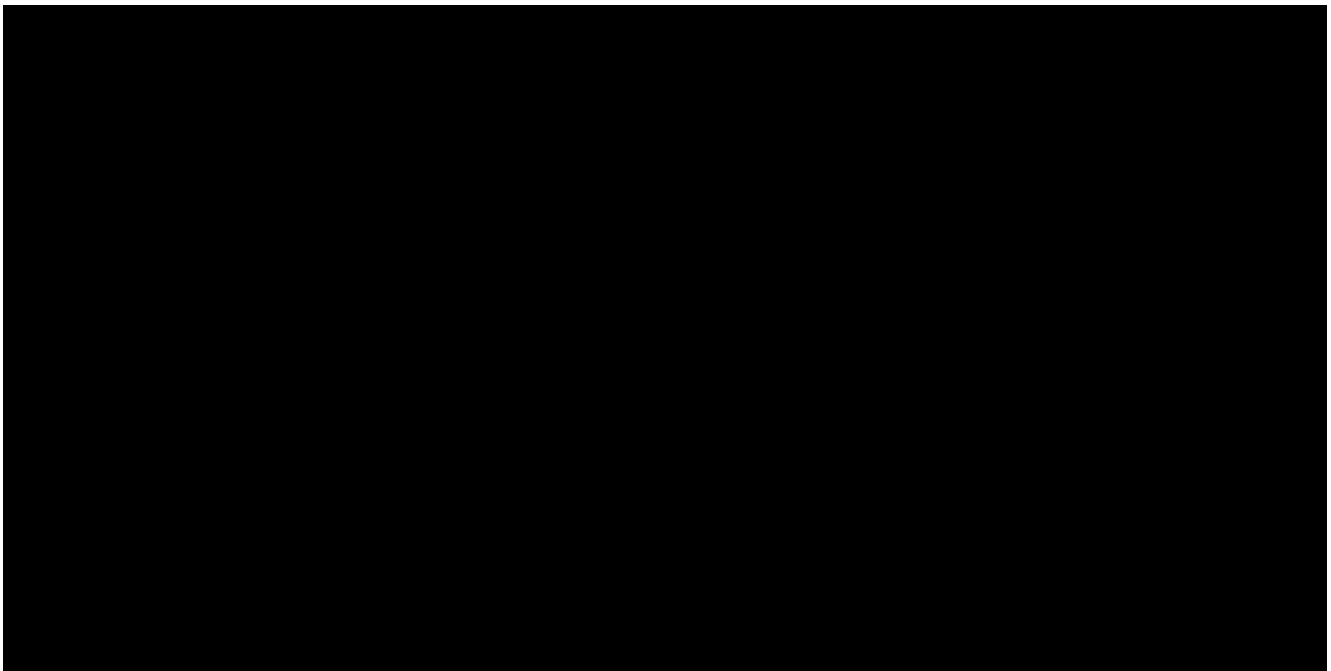

Figure 14.8 Screen Saver Interface

5. Press any button on the front to exit the screen saver program.

14.11 Reference Position

The reference position setting determines the physical point that the oscilloscope uses during vertical and horizontal scale changes. In some situations, it is more convenient to use a fixed position on the display.

1. Press the **Utility** key on the front panel and then press the **Reference Pos.** softkey to enter the Reference POS menu.
2. Press the **Vertical** softkey to select **Fixed Offset** or **Fixed Position**.
 - *Fixed Position*: when the vertical gain is changed, the oscilloscope will keep the vertical offset level indicator stationary.
 - *Fixed offset*: when the vertical gain is changed, the oscilloscope will have the vertical offset level indicator move with the actual voltage level.
3. Press the **Horizontal** softkey to select **Fixed Delay** or **Fixed Position**.
 - *Fixed Position*: when the timebase is changed, the oscilloscope will keep the horizontal offset indicator stationary.
 - *Fixed Delay*: when the timebase is changed, the oscilloscope will have the horizontal offset indicator move with the trigger point.

14.12 Power On Line

To set the power on line:

1. Press the **Utility** key on the front panel.
2. Press the **Power On Line** softkey to select **Enable** or **Disable**.
 - *Enable*: when the oscilloscope is energized, the oscilloscope will start automatically by itself.
 - *Disable*: when the oscilloscope is energized; then; press the power key at the lower-left corner of the front panel to start the oscilloscope.

Search

The 2194 provides a search function. This function can search for the events that users specify in the acquired data, the results are displayed with white triangle symbol. In the YT mode or the Roll mode with the acquisition in stop, the maximum search events number is 700. In the Roll mode with acquisition in run, the maximum search events number is unlimited. The waveform can be zoomed when search function is enabled.

15.1 Setting

1. Press the **Search** key on the front panel to enter the SEARCH function menu.
2. Press the **Mode** softkey and then use the **Universal Knob** to select the desired search type. the 2194 provides five search types: Edge, Slope, Pulse, Interval, Runt.



Figure 15.1 Search Menu

3. Press the **Setting** softkey to enter the SETTING function menu. The setting menu is different according to every search type. The details show as the following table.

Search Mode	Setting Menu Description
Edge	Slope includes Rising, Falling, Either.
Slope	Slope includes Rising, Falling Limit Range includes four types: \leq , \geq , $[-,-]$ and $-]$ $[-,$ Users can select the desired type and then input the time value.
Pulse	Polarity includes Positive and Negative Limit Range includes four types: \leq , \geq , $[-,-]$ and $-]$ $[-,$ Users can select the desired type and then input the time value.
Interval	Slope includes Rising, Falling Limit Range includes four types: \leq , \geq , $[-,-]$ and $-]$ $[-,$ Users can select the desired type and then input the time value.
Runt	Polarity includes Positive and Negative Limit Range includes four types: \leq , \geq , $[-,-]$ and $-]$ $[-,$ Users can select the desired type and then input the time value

Table 15.1 Search Modes

4. Press **Copy** softkey to enter COPY function menu.
 - *Copy from Trig*: copy the trigger setup for the selected search type to the search setup.
 - *Copy to Trig*: copy the setup for the selected search type to the same trigger type
 - *Cancel Copy*: undo a copy.
5. Press **Thresholds** softkey to enter THRESHOLDS function menu, then, to set channel search thresholds.

15.2 Results

When the acquisition is started, "EVENT NUM: 7" means total events number.

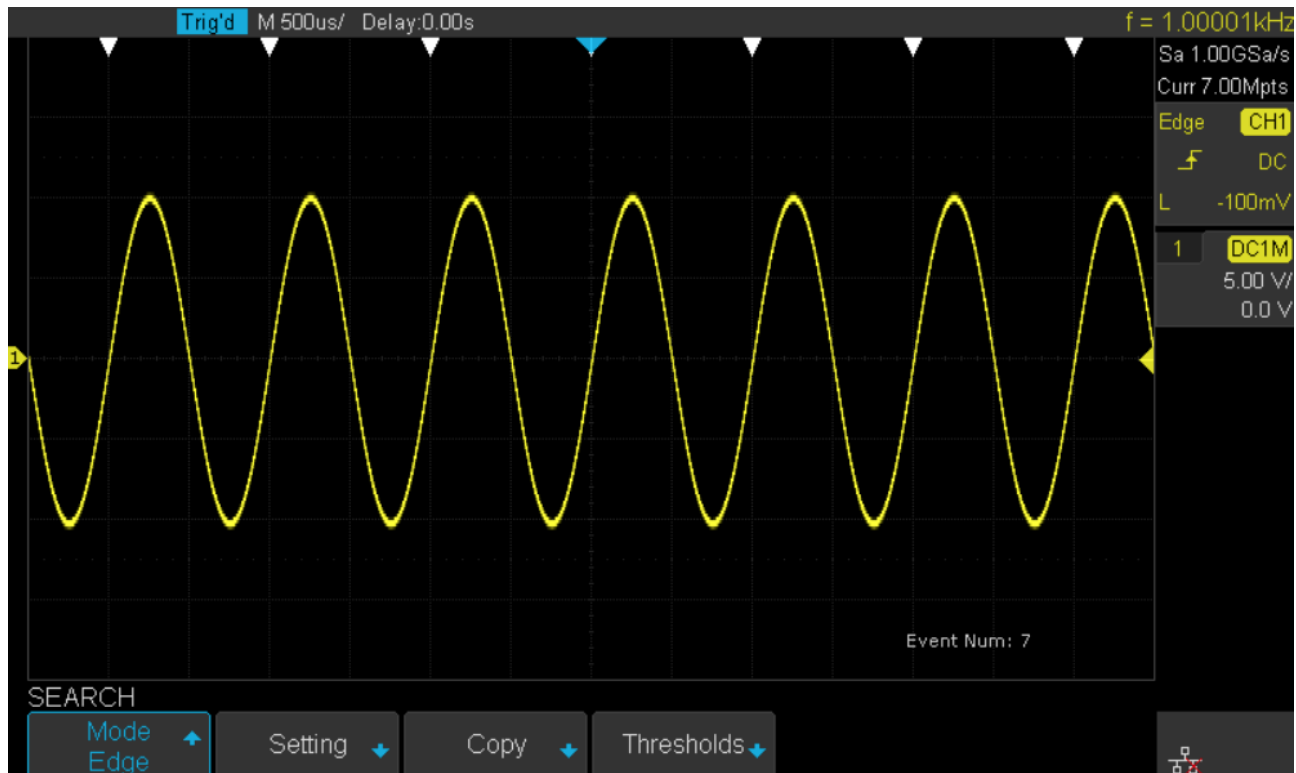

Figure 15.2 Search in Run

When the acquisition is stop, "EVENT NUM: 4/7" means current event number/total events number, the current event is the closest event to the middle of the screen.

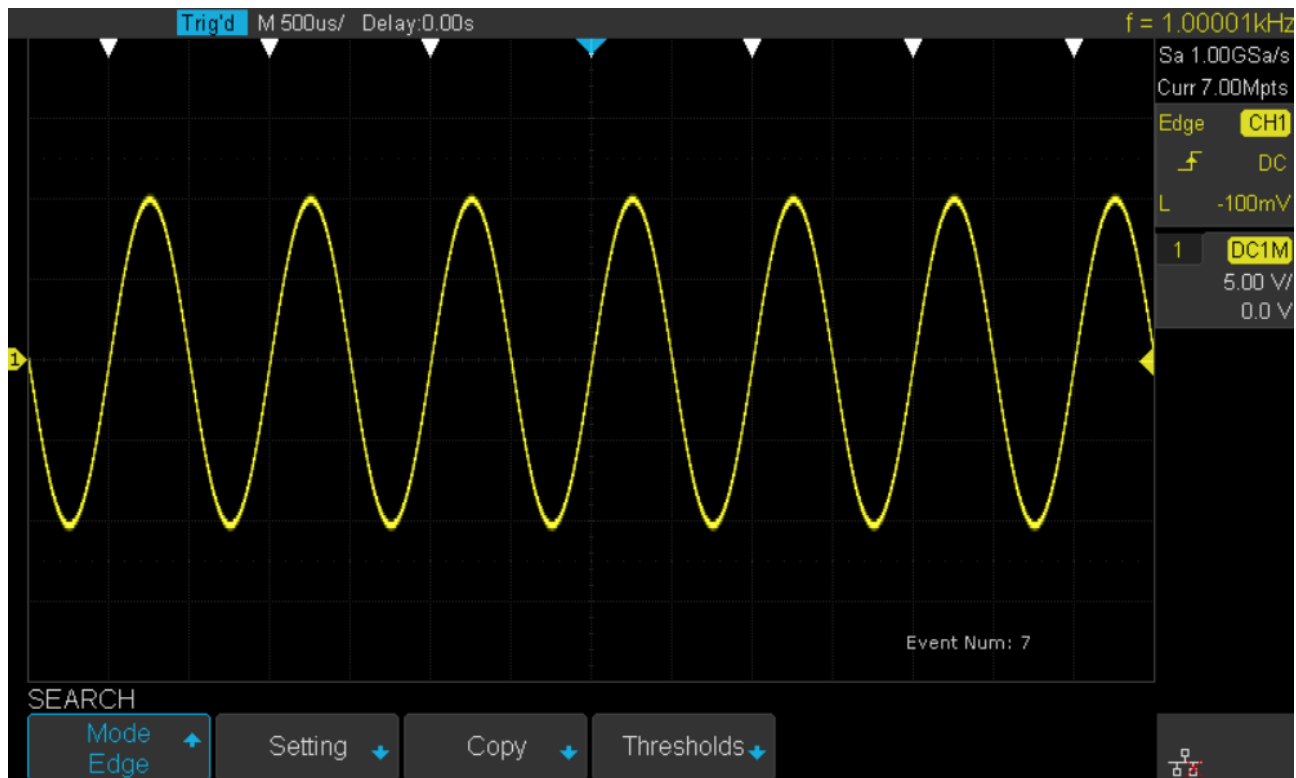





Figure 15.3 Search in Run

Navigate

The 2194 provides three navigate types: Search Event, Time , History Frame.

16.1 Time Navigate

1. Press the **Navigate** key on the front panel to enter the NAVIGATE function menu.
2. Press the **Type** softkey In the NAVIGATE function menu, then select Time.
3. There are two ways to navigate time.
 - a. Press the **Time** softkey, then, turn the **Universal Knob** to select the desired value or press the **Universal Knob** then enter the value by the pop keyboard.
 - b. Press the **navigation** keys  on the front panel to play backward, stop, or play forward in time.
You can press the  or  keys multiple times to speed up the playback. There are three speed levels: Low Speed, Medium Speed, and High Speed.

16.2 History Frame Navigate

When the History function is enabled, you can use the navigation controls to play through the acquired frames.

1. Press the **Navigate** key on the front panel to enter the NAVIGATE function menu.
2. Press the **Type** in the Navigate Menu, then select **History Frame**.
3. Press the **Frame Num** softkey, then there are two ways to navigate history frames.
 - a. Turn the **Universal Knob** to select the desired number or press the **Universal Knob** then enter the number by the pop keyboard.
 - b. Press the **navigation** keys  on the front panel to play backward, stop, or play forward

16.3 Search Event Navigate

When the Search function is enabled and acquisitions are stopped, you can use the navigation controls to go to found search events

1. Press the **Navigate** key on the front panel to enter the NAVIGATE function menu.
2. Press the **Type** in the NAVIGATE function menu, then select **Search Event**.
3. There are two ways to navigate search events.
 - a. Press **Event Num** softkey, then, turn the **Universal Knob** to select the desired value or press the **Universal Knob** then enter the value by the pop keyboard.
 - b. Press the **Navigate** keys  on the front panel to go to the previous or next search event.

History

The history function can record the waveforms of the input channels before press the **Run/Stop** button. In run state, the oscilloscope records input waveform continually; when the memory is full (reach the maximal frame), the new frames will cover the old frames and keep the latest frames. To use the History function, the HORIZONTAL **Format** must be set to **YT**. To record and replay waveform:

1. Press the **History** button on the front panel to enable the History function.
 - When in run state, the waveform will enter the stop state.
 - When in stop state, and then enable the History function, the oscilloscope will keep the stop state.
 - Press **History** or **Stop** button to turn off History function.
2. Press the **List** softkey to turn on or off the list display. The list records the timestamp of every frame. It is accurate to microseconds.

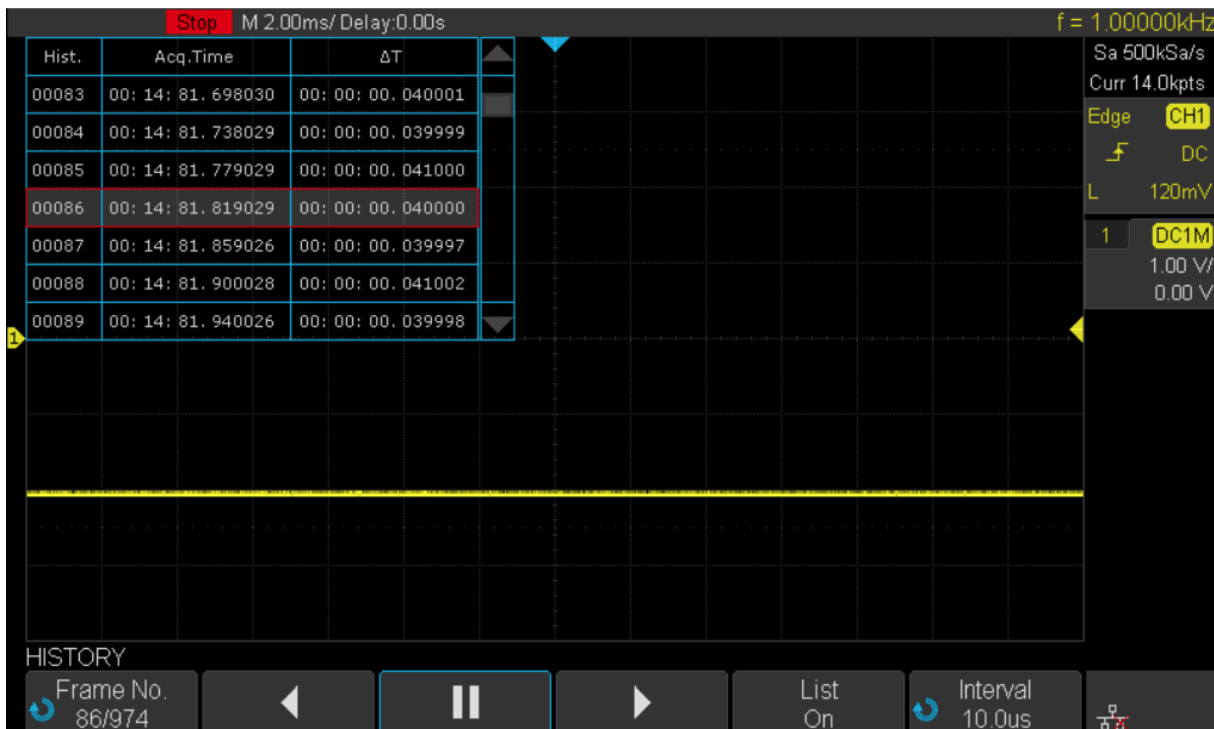





Figure 17.1 History

3. Press the **Frame** softkey; then turn the **Universal Knob** to select the frame to display.
 - The format of the **Frame** is A/B; A is the frames number that displaying on the screen and B is the maximal frame number you can set.
 - The maximal frame number is determined by the current sampling point (**Curr** value) and sampling rate
 - When press the **Run/Stop** button or enable the history function, you may not get the maximal frames, because the memory is not filled. So if you want to get the maximal frames, please wait for enough time for acquisition.
4. Press the  softkey to replay the waveform from the current frame to 1.
5. Press the  softkey to stop replay.
6. Press the  softkey to replay the waveform from the current frame to the last frame.

Factory Setup

Press **Save/Recall** function key, then press **Save** menu select **To Default Key** set the type to **Factory Setup**. Then press the **Default** button on the front to set the oscilloscope to the leave factory setup. Another way is press **Save/Recall** function key, then press **Recall** menu select **Factory Default** to recall.

Troubleshooting

The commonly encountered failures and their solutions are listed below. When you encounter those problems, please solve them following the corresponding steps. If the problem remains still, please contact BK Precision.

The screen is still dark (no display) after power on

1. Check whether the power is correctly connected.
2. Check whether the power switch is really on.
3. Check whether the fuse is burned out. If the fuse needs to be changed, please use the specified fuse.
4. Restart the instrument after finishing the above inspections.
5. If it still does not work correctly, please contact BK Precision.

The signal is sampled but no waveform of the signal is displayed

1. Check whether the probe is correctly connected to the signal connecting wire.
2. Check whether the signal connecting wire is correctly connected to the BNC (namely channel connector).
3. Check whether the probe is correctly connected to the item to be tested.
4. Check whether there are signals generated from the item to be tested (you can connect the probe compensation signal to the problematic channel to determine which has problem, the channel or the item to be tested).
5. Resample the signal.

The tested voltage amplitude is greater or lower than the actual value

Check whether the attenuation coefficient of the channel complies with the attenuation ratio of the probe.

Note:

This problem usually occurs when probe is used.

There is waveform display but not stable

1. Check the trigger signal source: check whether the **Source** item at the trigger panel complies with the signal channel actually used.
2. Check the trigger type: general signals should use "Edge" trigger and video signal should use "Video" trigger. Only when the proper trigger type is used, can the waveform be displayed stably.
3. Change the trigger holdoff setting.

No display after pressing Run/Stop

Check whether the mode at the trigger panel (TRIGGER) is on “Normal” or “Single” and whether the trigger level exceeds the waveform range. If yes, set the trigger level to the middle or set the mode to “Auto”.

Note:

Using AUTO could automatically finish the above setting.

The display of waveform is ladder-like

1. The horizontal time base might be too low. Increase the horizontal time base to increase the horizontal resolution and improve the display.
2. If the display **Type** is “Vectors”, the lines between the sample points may cause ladder-like display. Set **Type** to “Dots” to solve the problem.

Fail to connect PC through USB

Check the **IO Setting** in **Utility** to make sure whether the setting in **USB Device** matches the device currently connected. If needed, restart the oscilloscope.

The USB storage device cannot be recognized

1. Check whether the USB storage device can work normally.
2. Make sure whether the USB interface can work normally.
3. Make sure that the USB storage device being used is flash storage type. This oscilloscope does not support hardware storage type.
4. Restart the instrument and then insert the USB storage device to check it.
5. If the USB storage device still cannot be used normally, please contact BK Precision.

Service Information

Warranty Service: Please go to the support and service section on our website at bkprecision.com to obtain an RMA #. Return the product in the original packaging with proof of purchase to the address below. Clearly state on the RMA the performance problem and return any leads, probes, connectors and accessories that you are using with the device.

Non-Warranty Service: Please go to the support and service section on our website at bkprecision.com to obtain an RMA #. Return the product in the original packaging to the address below. Clearly state on the RMA the performance problem and return any leads, probes, connectors and accessories that you are using with the device. Customers not on an open account must include payment in the form of a money order or credit card. For the most current repair charges please refer to the service and support section on our website.

Return all merchandise to B&K Precision Corp. with prepaid shipping. The flat-rate repair charge for Non-Warranty Service does not include return shipping. Return shipping to locations in North America is included for Warranty Service. For overnight shipments and non-North American shipping fees please contact B&K Precision Corp.

Include with the returned instrument your complete return shipping address, contact name, phone number and description of problem.

B&K Precision Corp.
22820 Savi Ranch Parkway
Yorba Linda, CA 92887
bkprecision.com
714-921-9095

LIMITED THREE-YEAR WARRANTY

B&K Precision Corp. warrants to the original purchaser that its products and the component parts thereof, will be free from defects in workmanship and materials for a period of **three years** from date of purchase.

B&K Precision Corp. will, without charge, repair or replace, at its option, defective product or component parts. Returned product must be accompanied by proof of the purchase date in the form of a sales receipt.

To help us better serve you, please complete the warranty registration for your new instrument via our website www.bk-precision.com

Exclusions: This warranty does not apply in the event of misuse or abuse of the product or as a result of unauthorized alterations or repairs. The warranty is void if the serial number is altered, defaced or removed.

B&K Precision Corp. shall not be liable for any consequential damages, including without limitation damages resulting from loss of use. Some states do not allow limitations of incidental or consequential damages. So the above limitation or exclusion may not apply to you.

This warranty gives you specific rights and you may have other rights, which vary from state-to-state.

B&K Precision Corp.
22820 Savi Ranch Parkway
Yorba Linda, CA 92887
www.bkprecision.com
714-921-9095