

Yamato

Constant Temperature Water Bath

Model

BK300/400/500/610/710

Instruction Manual

- First Edition -

- Thank you for purchasing " Constant Temperature Water Bath, BK Series" of Yamato Scientific Co., Ltd.
- To use this unit properly, read this "Instruction Manual" thoroughly before using this unit. Keep this instruction manual around this unit for referring at anytime.

⚠WARNING!

Carefully read and thoroughly understand the important warning items described in this manual before using this unit.

**Yamato Scientific America Inc.
Santa Clara, CA**

◆ Cautions in Using with Safety	1
• Explanation	1
• Table of Illustrated Symbols	2
• Fundamental Matters of “WARNING!” and “CAUTION!”	3
◆ Before Using this unit	4
• Requirements for Installation	4
◆ Description and Function of Each Part	7
• Main Unit	7
• Control Panel	8
• Characters of Thermo Controller	9
• Operation Mode and Function List	10
• Operation Mode, Function Setting Key, and Characters	12
• Setting of Overheating Prevention Device	13
• Fixed Temperature Operation	14
• Quick Auto Stop Operation	15
• Auto Stop Operation	16
• Auto Start Operation	18
• Other Functions	20
◆ Handling Precautions	21
◆ Maintenance Method	23
• Daily Inspection and Maintenance	23
◆ Long storage and disposal	24
• When not using this unit for long term / When disposing	24
◆ In the Event of Failure	25
• Error Display	25
◆ After Service and Warranty	27
◆ Specification	28
◆ Wiring Diagram	29
◆ Replacement Parts Table	30
◆ Reference	31
• List of Dangerous Substances	31

Explanation

MEANING OF ILLUSTRATED SYMBOLS

Illustrated Symbols

Various symbols are used in this safety manual in order to use the unit without danger of injury and damage of the unit. A list of problems caused by ignoring the warnings and improper handling is divided as shown below. Be sure that you understand the warnings and cautions in this manual before operating the unit.

 **WARNING!** If the warning is ignored, there is the danger of a problem that may cause a serious accident or even fatality.

 **CAUTION!** If the caution is ignored, there is the danger of a problem that may cause injury/damage to property or the unit itself.

Meaning of Symbols



This symbol indicates items that urge the warning (including the caution). A detailed warning message is shown adjacent to the symbol.



This symbol indicates items that are strictly prohibited. A detailed message is shown adjacent to the symbol with specific actions not to perform.



This symbol indicates items that should be always performed. A detailed message with instructions is shown adjacent to the symbol.

Table of Illustrated Symbols

Warning



Warning, generally

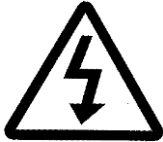

Warning, high voltage



Warning, high temperature



Warning, drive train



Warning, explosive

Caution



Caution, generally



Caution, electrical shock



Caution, scald



Caution, no road heating



Caution, not to drench



Caution, water only



Caution, deadly poison

Prohibit



Prohibit, generally



Prohibit, inflammable



Prohibit, to disassemble



Prohibit, to touch

Compulsion



Compulsion, generally



Compulsion, connect to the grounding terminal



Compulsion, install on a flat surface



Compulsion, disconnect the power plug



Compulsion, periodical inspection

Cautions in Using with Safety

Fundamental Matters of “WARNING!” and “CAUTION!”

WARNING!

Do not use this unit in an area where there is flammable or explosive gas

Never use this unit in an area where there is flammable or explosive gas. This unit is not explosion-proof. An arc may be generated when the power switch is turned on or off, and fire/explosion may result. (Refer to page31 “List of Dangerous Substances”.)

Always ground this unit

Always ground this unit on the power equipment side in order to avoid electrical shock due to a power surge.

If a problem occurs

If smoke or strange odor should come out of this unit for some reason, turn off the power key right away, and then turn off the circuit breaker and the main power. Immediately contact a service technician for inspection. If this procedure is not followed, fire or electrical shock may result. Never perform repair work yourself, since it is dangerous and not recommended.

Do not use the power cord if it is bundled or tangled

Do not use the power cord if it is bundled or tangled. If it is used in this manner, it can overheat and fire may be caused.

Do not process, bend, wring, or stretch the power cord forcibly

Do not process, bend, wring, or stretch the power cord forcibly. Fire or electrical shock may result.

Substances that can not be used

Never use explosive substances, flammable substances and substances that include explosive or flammable ingredients in this unit. Explosion or fire may occur.

Do not disassemble or modify this unit

Do not disassemble or modify this unit. Fire or electrical shock or failure may be caused.

Do not touch high-temperature parts

The inside of the body or the door may become hot during and just after operation. It may cause burns.

CAUTION!

During a thunder storm

During a thunderstorm, turn off the power key immediately, then turn off the circuit breaker and the main power. If this procedure is not followed, fire or electrical shock may be caused.

Requirements for Installation

WARNING!

1. Always ground this unit



- Connect the power plug to a receptacle with grounding connectors.



- Do not forget to ground this unit, to protect you and the unit from electrical shock in case of power surge. Choose a receptacle with grounding connectors as often as possible.
- Do not connect the grounding wire to a gas pipe, or by means of a lightning rod or telephone line. A fire or electrical shock will occur.
- Though BK400/500 model is the 115V single phase model, these two models have the large electric capacity. Be sure to prepare the power switchboard with the specific ground earth or specific receptacle.
- BK610/710 model is the 220V single phase mode. Be sure to connect this model to the specific power switchboard or receptacle for 220V.

2. Choose a proper place for installation



- Do not install this unit in a place where:
 - ◆ Rough or dirty surface.
 - ◆ Flammable gas or corrosive gas is generated.
 - ◆ Ambient temperature exceeds 35°C.
 - ◆ Ambient temperature fluctuates violently.
 - ◆ There is direct sunlight.
 - ◆ There is excessive humidity and dust.
 - ◆ There is a constant vibration.



- Install this unit on a stable place with the space as shown below. This unit should be installed horizontally by using adjusters on the four corners.

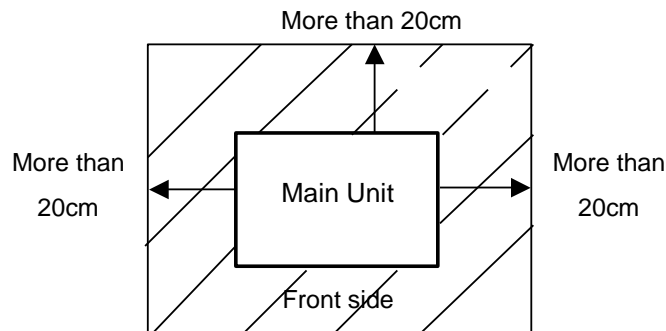

Requirements for Installation

3. Do not use this unit in an area where there is flammable or explosive gas



- Never use this unit in an area where there is flammable or explosive gas. This unit is not explosion-proof. An arc may be generated when the power switch is turned ON or OFF, and fire/explosion may result.

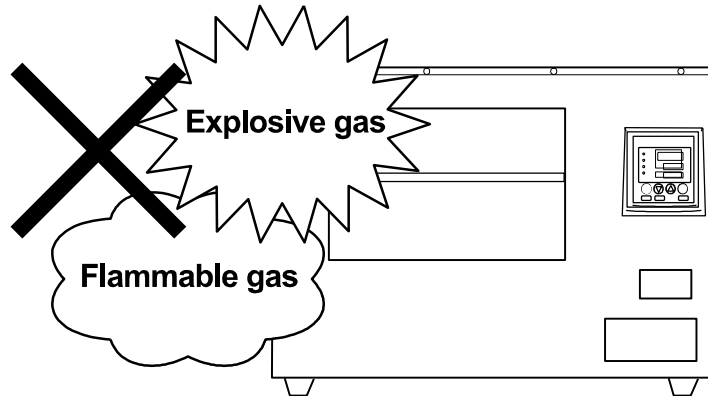

4. Do not modify



- Modification of this unit is strictly prohibited. This could cause a failure.

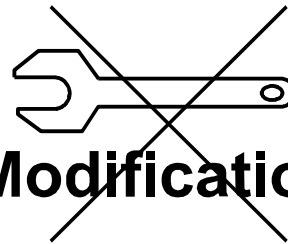
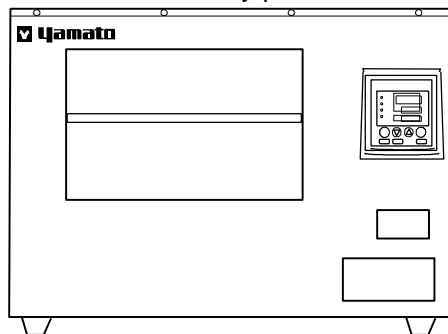

5. Installation on horizontal surface



- Set this unit to the flattest place. Not setting this unit with its 4 legs covered with rubber contacted to the setting place surface evenly could cause the vibration or noise, or cause the unexpected trouble or malfunction.

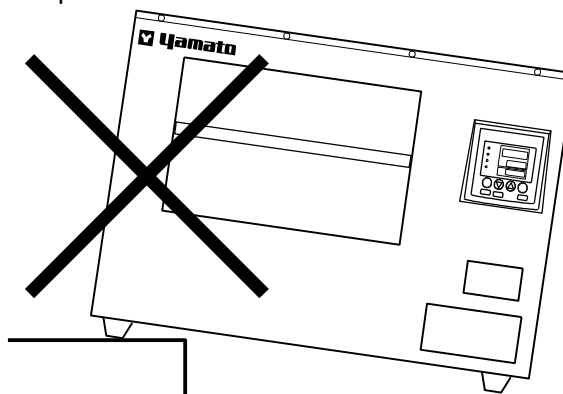

Requirements for Installation

CAUTION!

6. Choose a correct power distribution board or receptacle



- Choose a correct power distribution board or receptacle that meets the unit's rated electric capacity.

Electric capacity:	BK300: AC115 V, 11.5A
	BK400: AC115 V, 20A
	BK500: AC115 V, 21.5A
	BK610: AC220 V (Single phase), 16A
	BK710: AC220 V (Single phase), 20.5A

NOTE)

There could be the case that the unit does not run even after turning ON the power. Inspect whether the voltage of the main power is lowered than the specified value, or whether other device(s) uses the same power line of this unit. If the phenomena might be found, change the power line of this unit to the other power line.

7. Before/after installing



- It may cause injure to a person if this unit falls down or moves by the earthquake and the impact. etc..To prevent, take measures that the unit cannot fall down, and not install to busy place.

8. Handling of power code



- Do not entangle the power cord. This will cause overheating and possibly a fire.
- Do not bend or twist the power cord, or apply excessive tension to it. This may cause a fire and electrical shock.
- Do not lay the power cord under a desk or chair, and do not allow it to be pinched in order to prevent it from being damaged and to avoid a fire or electrical shock.
- Keep the power cord away from any heating equipment such as a room heater. The cord's insulation may melt and cause a fire or electrical shock.



- If the power cord becomes damaged (wiring exposed, breakage, etc.), immediately turn off the power at the rear of this unit and shut off the main supply power. Then contact your nearest dealer for replacement of the power cord. Leaving it may cause a fire or electrical shock.
- Connect the power plug to the outlet which is supplied appropriate power and voltage.

Description and Function of Each Part

Main Unit

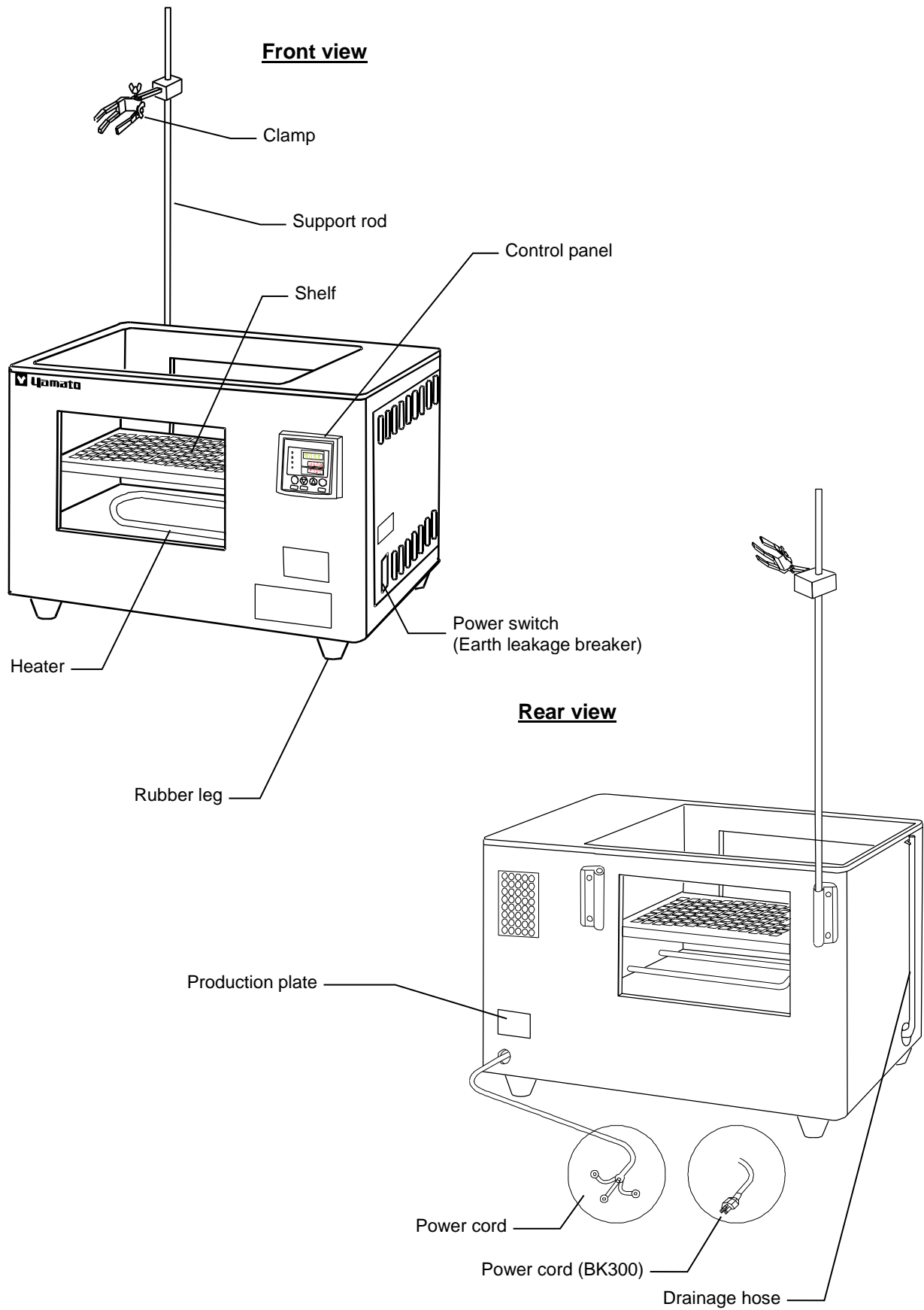

Description and Function of Each Part



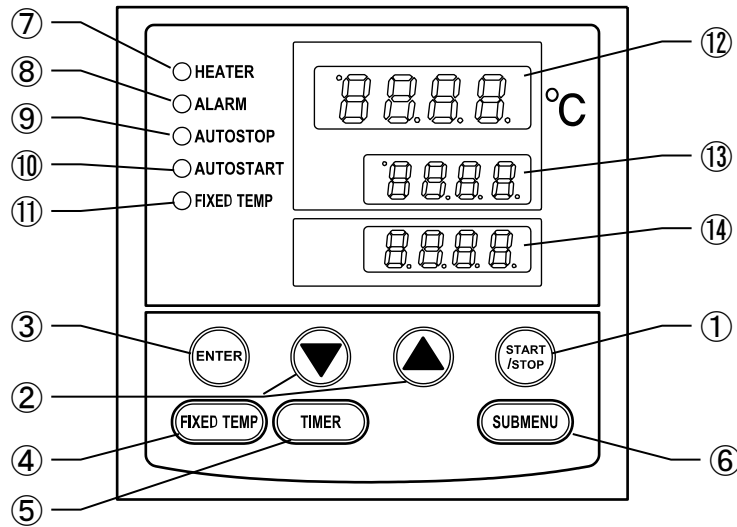





Control Panel

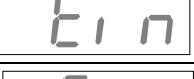

①	START/STOP Key :	Starts/stops the operation.
②	▲▼ Key :	Uses for rising UP/lowering DOWN the setting value.
③	ENTER Key :	Settles the inputted value.
④	FIXED TEMP Key :	Chooses the fixed temperature operation.
⑤	TIMER Key :	Chooses the timer operation (Quick Auto Stop/Auto Stop/Auto Start).
⑥	SUBMENU Key :	Uses for setting the overheating prevention temperature, calibration offset temperature, and key lock function.
⑦	HEATER Lamp :	Lights while the heater works.
⑧	ALARM Lamp :	Lights up when an error occurs. (Buzzer sounds simultaneously.)
⑨	AUTO STOP Lamp :	Blinks while setting quick auto stop timer or auto stop timer. Lights while quick auto stop timer or auto stop timer is running.
⑩	AUTO START Lamp :	Blinks while setting auto start timer. Lights while auto start timer is running.
⑪	FIXED TEMP Lamp :	Blinks while setting fixed temperature operation. Lights while fixed temperature operation is running.
⑫	Measurement Temperature Display :	Displays the measured temperature, setting character, alarm information.
⑬	Setting Temperature Display :	Displays the setting temperature, setting value for timer mode, remaining time.
⑭	Overheating Prevention Temperature Display :	Displays the setting temperature for overheating prevention device.

Description and Function of Each Part

Characters of Thermo Controller

Character	Identifier	Name	Purpose
	FiX	Fixed Temperature Setting Mode	Used for starting the fixed temperature operation.
	Sv	Temperature Setting	Used for setting the temperature.
	AStP	Timer Setting Mode Display	Represents the setting of quick auto stop or auto stop operation.
	AStr	Timer Setting Mode Display	Represents the setting of auto start operation.
	tim	Time Setting	Used for setting the time.
	End	Time Up	Displays when the timer operation is completed.
	cAL	Calibration Offset Setting	Used for inputting the calibration offset temperature. (Refer to Page 20 "Use calibration offset function".)
	oH	Overheating Prevention Setting	Used for setting temperature for overheating prevention device. (Refer to Page 13 "Setting of Overheating Prevention Device".)
	LocK	Key Lock	Locks the keys on control panel to protect from unnecessary operation. (Refer to Page 20 "Use lock function".)

* Also refer to Page 12 "Operation Mode, Function Setting Key, and Characters".

Operation Mode and Function List

All the operation mode of this unit is as follows;

No.	Name	Description	Page
1.	Fixed Temperature Operation	Pressing the FIXED TEMP key enters into the fixed temperature operation setting mode. Pressing it again enters into the temperature setting mode. The "▲▼" are used to set temperature. Pressing the START/STOP key starts or stops operation.	14
2.	Quick Auto Stop Operation	This operation is used to specify the period up to automatic stop during operation. The period up to operation stop can be set by pressing the TIMER key during fixed temperature operation. The "▲▼" are used to set the time. Pressing the START key starts the quick auto stop operation, activates the timer function and stops the operation automatically after specified period.	15
3.	Auto Stop Operation	This operation is used to specify the automatic stop time in the fixed temperature operation. Pressing the TIMER key displays "AS t p". The setting temperature "SV" can be set by pressing the ENTER key. The operation time "tim" can be set by pressing it again. Pressing the START/STOP key starts the auto stop operation.	16
4.	Auto Start Operation	This operation is used to specify the period up to automatic start after power on. Pressing the TIMER key displays "AS t r". The setting temperature "SV" can be set by pressing the ENTER key. The operation time "tim" can be set by pressing it again. Pressing the START/STOP key starts the auto start operation.	18

NOTE) This unit is impossible to be changed the mode during the operation. If the mode requires to be changed, stop the operation.

Operation Mode and Function List

The operation function of this unit is as follows;

No.	Name		Description	Page
1.	Overheating prevention function	Auto overheating prevention function	This function is set to be automatically activated (auto reset) when the temperature exceeds the setting temperature by 12°C.	13
		Overheating prevention device	Though the device shares power source, display, and key input with the controller, it has independent temperature measurement circuit, CPU, sensor and output circuit. Overheating prevention temperature can be set using the operation panel. The unit stops operation when the device is activated. The unit starts operation again when the POWER switch is pressed again (manual reset).	
2.	Calibration offset function		This calibration offset function is for calibrating the difference occurred between the required in- furnace temperature and control temperature (sensor temperature) of the controller. This unit can be calibrated toward either plus side or minus side of the whole temperature range.	20
3.	Overheating prevention temperature calibration function		The temperature of overheating prevention device is automatically corrected when the temperature of controller is collected.	-
4.	Recovery at power failure		The unit starts operation with the same condition as just before power failure if it occurs during operation. Press the START/STOP key to start the unit again.	-
5.	Setting value locking		This function locks the established operation status. It can be set and cancelled with the SUBMENU key.	20

Operation Mode, Function Setting Key, and Characters

The operation mode setting and function setting use the key operation and characters show in the following figure.

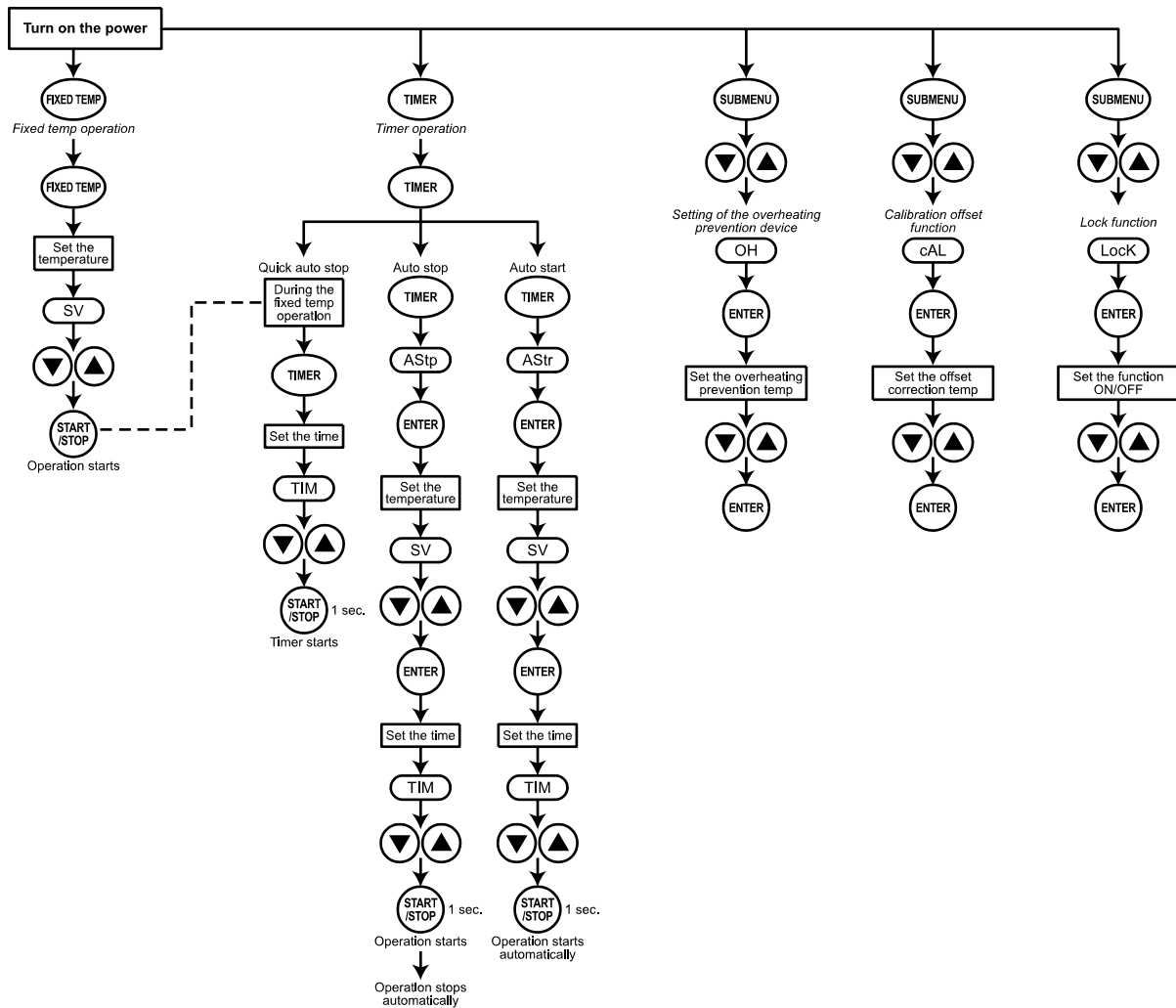

Setting of Overheating Prevention Device

The unit has the overheating prevention device (manual reset) that consists of independent temperature measurement circuit, CPU, sensor and output circuit (it shares power source, display, and key input with the controller) in addition to the automatic overheating prevention function (auto reset) in the controller.

Setting range/function

The unit has failsafe functions against overheating. One of them is built in the controller and previously set at factory shipment so to be automatically activated when the temperature exceeds the setting temperature of temperature controller by 6°C, where the heater repeats on and off.

The other is united with the controller, which can be set by operating the keys on the controller.

The setting range of latter is from 0°C to 130°C.

In case the temperature in furnace exceeds the setting temperature of controller to reach to that of overheating prevention device, the circuit is shut off and "Er19" is displayed with blinking on the screen of controller with buzzer sound.

If the device is once activated, "Er19" continues to be displayed until the power is newly turned on.

Temperature setting procedure

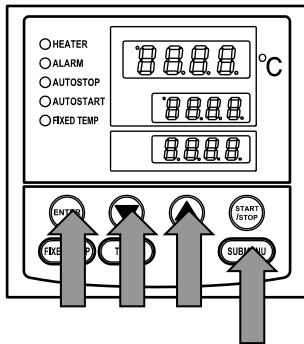

1. Turn on the power (turn on the breaker in front)

- The default value is displayed for about four seconds after turning on the power. The screen then displays the initial setting. The current temperature in furnace, operation mode character and setting temperature of overheating prevention device are displayed on respective screens.

2. Set the temperature for overheating prevention

- Press the SUBMENU key.
- Press the "▼▲" several times to select the setting character of overheating prevention temperature "OH".
- Press the ENTER key. The current setting temperature is displayed with blinking on the setting temperature screen.

Note: To prevent improper operation, set the value 10°C or more over the setting temperature of controller.

- Select the value using the "▼▲" and then press the ENTER key. This completes the setting.

Notes:



- The standard setting temperature of device is "the maximum setting temperature of unit plus 10°C" or "setting temperature plus 10°C". If the unit performs improper operation, increase it 5°C more.
- The setting range of overheating prevention device is from 0°C to 130°C. Improper setting of temperature may cause inoperative of unit, malfunction of device, e.g. it is activated during increasing in temperature in furnace, or unexpected accidents such as fire disaster. To prevent such matters, set a proper value. **The temperature is set at 90°C beyond these setting values. In this case, follow the instruction ③ of Section 2 above.**
- In some case, the overheating prevention device is possible to be activated by mistake when its yield temperature is set to around room temperature.
- The purpose of overheating prevention device is to protect the unit from overheating. It does not intend to protect the samples, or to protect them from the accident caused by the use of explosive or inflammability.

Fixed Temperature Operation

Fixed temperature operation procedure

1. Turn on the power (turn on the breaker in front)

- ❖ The default value is displayed for about four seconds after turning on the power. The screen then displays the initial setting. The current temperature in furnace, operation mode character and setting temperature of overheating prevention device are displayed on respective screens.

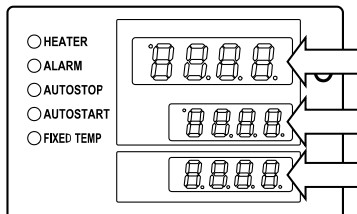

Measurement temperature screen:

Displays the current temperature in furnace.

Setting temperature screen:

Displays the operation mode character. (Refer to Page エラー! ブックマーク)

Overheating prevention screen:

Displays the setting temperature of overheating prevention device

2. Select the operation mode

- Press the FIXED TEMP key to display "FIX", which indicates the fixed temperature operation, on the center display screen.

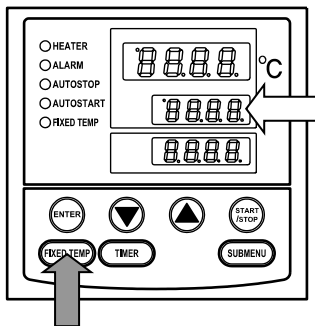

3. Set the temperature

- Press the FIXED TEMP key again.
- The setting temperature screen displays the character "SV" which indicates the temperature setting. Also it displays the current setting temperature with blinking. The FIXED TEMP lamp blinks, too.
- Set the temperature by pressing the "▼▲".

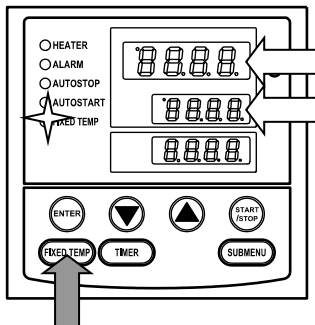

4. Start operation

- Press the orange START/STOP key for about one second. The unit starts operation and the blinking FIXED TEMP lamp lights on.

5. Stop operation

- Press the orange START/STOP key for about one second. The unit stops operation and the FIXED TEMP lamp lights off. The screen returns to the initial setting screen.

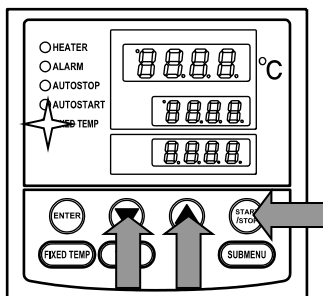

To correct or check setting...

Press the FIXED TEMP key again to correct or check the setting.

Changing the setting temperature during operation is also possible by pressing the FIXED TEMP key.

Quick Auto Stop Operation

Quick auto stop operation procedure

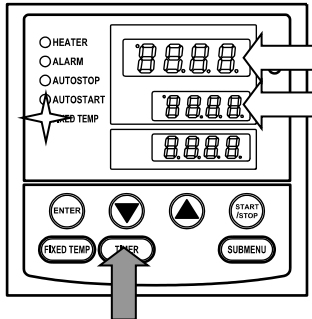

This operation is used to specify the period up to automatic stop, i.e., sets the auto stop timer during operation.

1. Set the time up to stop during fixed temperature operation

- Check that the FIXED TEMP lamp lights on and that the unit is under operation.
- Press the TIMER key.
- The measurement temperature display screen displays the character "tim", which indicates the timer setting. The setting temperature display screen displays the current setting time with blinking.
- Select the time by pressing the "▼▲".

Timer function:

- The maximum setting time is "999 hours and 50 minutes".
- The time can be set in increments of a minute under 99 hours and 59 minutes.
- It can be set in increment of ten minutes over 100 hours.
- The "▼▲" can change the setting time quickly when it is pressed continuously. Press them discontinuously when fine adjustment is needed.

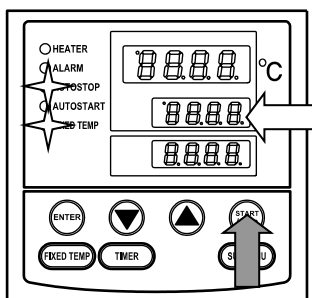

2. Start timer operation

- Press the START/STOP key for one second after deciding the time.
- Timer operation starts with the FIXED TEMP and AUTO STOP lamps lighting on.
- The timer is activated at the point when the START/STOP key is pressed.

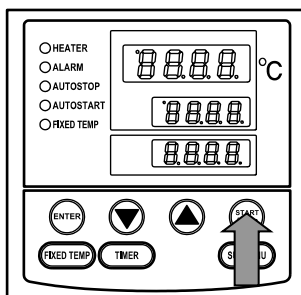

3. Stop/terminate timer operation

- The operation stops automatically at setting time.
- Buzzer continues to sound for about five minutes at operation stop.
- The setting temperature screen displays the character "End", which indicates termination of operation, with the FIXED TEMP and AUTO STOP lamps lighting on. Press the START/STOP key to terminate the timer operation mode. The screen returns to the initial setting screen.

To correct or check setting...

Changing the setting temperature during operation is possible by pressing the FIXED TEMP key. Press the ENTER key after changing the setting.

Changing the setting temperature during operation is available by pressing the FIXED TEMP key. Press the ENTER key after changing the setting.

Press the ▼ key to display the setting temperature, operation mode and residual time on the setting temperature screen.

Auto Stop Operation

Auto stop operation procedure

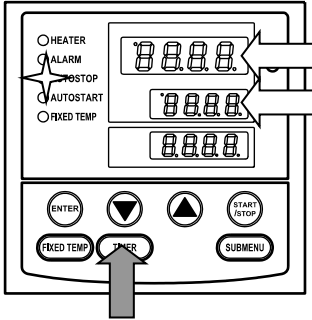

This operation is used to specify the automatic stop time in the fixed temperature operation.

1. Set stop time

- ① Press the TIMER key on the initial screen.
Press the TIMER key again. The setting temperature display screen displays the character "AstP", which indicates the auto stop operation, with blinking.
- ② Press the ENTER key.
The measurement temperature screen displays the character "SV", which indicates the temperature setting. The setting temperature screen displays the current setting temperature with blinking. The AUTO STOP lamp blinks, too.
- ③ Set the temperature using the "▼▲".
- ④ Press the ENTER key again.
The measurement temperature display screen displays the character "tim", which indicates the timer setting. The setting temperature display screen displays the current setting time with blinking.
- ⑤ Set the time using the "▼▲".

Timer function:

- The maximum setting time is "999 hours and 50 minutes".
- The time can be set in increments of a minute under 99 hours and 59 minutes.
- It can be set in increment of ten minutes over 100 hours.
- The "▼▲" can change the setting time quickly when it is pressed continuously. Press them discontinuously when fine adjustment is needed.

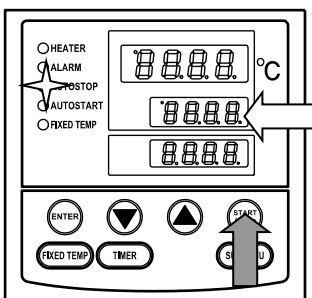

2. Start timer operation

- Press the START/STOP key for one second after deciding the time.
- Timer operation starts with the AUTO STOP lamp lighting on.
- The timer is activated at the point when the temperature in furnace (measurement temperature) reaches to the setting temperature.

Auto Stop Operation

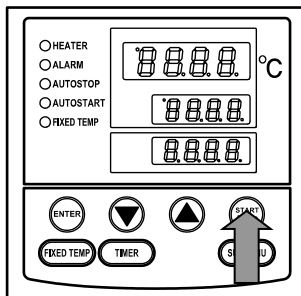

3. Stop/terminate timer operation

- The operation stops automatically at setting time.
- Buzzer continues to sound for about five minutes at operation stop.
- The setting temperature screen displays the character "End", which indicates termination of operation, with the FIXED TEMP and AUTO STOP lamps lighting on. Press the START/STOP key to terminate the timer operation mode. The screen returns to the initial setting screen.

To correct or check setting...

Changing the setting temperature or time during operation is possible by pressing the TIMER key. Use the "▼▲" to change the setting value. Press the ENTER key respectively after changing the setting.

Press the "▼" to display the setting temperature, operation mode and residual time on the setting temperature screen.

Auto Start Operation

Auto start operation procedure

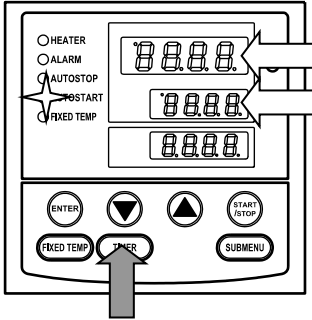

This operation is used to specify the period up to automatic start after power on.

1. Set start time

- ① Press the TIMER key on the initial screen.
Press the TIMER key again. The setting temperature display screen displays the character "Astr", which indicates the auto start operation, with blinking.
- ② Press the ENTER key.
The measurement temperature screen displays the character "SV", which indicates the temperature setting. The setting temperature screen displays the current setting temperature with blinking. The AUTO START lamp blinks, too.
- ③ Set the temperature using the "▼▲".
- ④ Press the ENTER key again.
The measurement temperature display screen displays the character "tim", which indicates the timer setting. The setting temperature display screen displays the current setting time with blinking.
- ⑤ Set the time using the "▼▲".

Timer function:

- The maximum setting time is "999 hours and 50 minutes".
- The time can be set in increments of a minute under 99 hours and 59 minutes.
- It can be set in increment of ten minutes over 100 hours.
- The "▼▲" can change the setting time quickly when it is pressed continuously. Press them discontinuously when fine adjustment is needed.

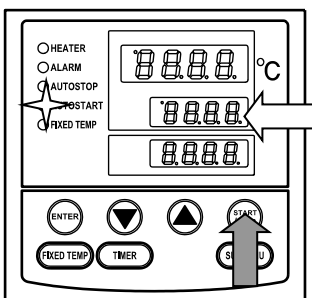

2. Start timer operation

- Press the START/STOP key for one second after deciding the time.
- Timer operation starts with the AUTO START lamp lighting on.

Auto Start Operation

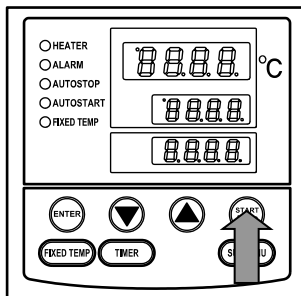

3. Stop/terminate timer operation

- The operation starts automatically at setting time.
- Press the START/STOP key for one second to stop or terminate operation. The screen returns to the initial setting screen.

To correct or check setting...

Changing the setting temperature or time during operation is possible by pressing the TIMER key. Use the "▼▲" to change the setting value. Press the ENTER key respectively after changing the setting. They are not changeable after the unit starts operation. In this case, stop the operation by pressing the START/STOP key, then set the value again.

Press the "▼" to display the setting temperature, operation mode and residual time on the setting temperature screen.

Other Functions

Use calibration offset function

Calibration offset is a function which corrects the difference between the temperature in furnace and that of controller (sensor temperature) if arises. The function parallel corrects the difference either to the plus or minus side within the whole temperature range of unit. The function can be set or cancelled by the SUBMENU key.

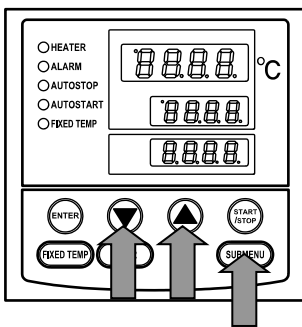
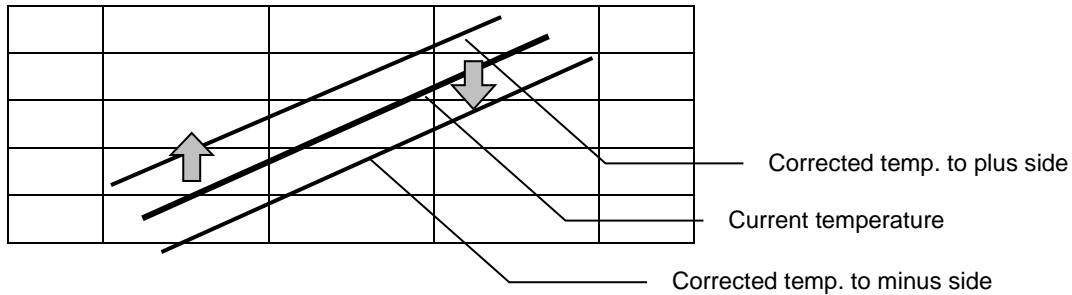

- ① Start operation with the target setting temperature. Check the temperature in furnace (temperature of sample) with a thermograph after it is stabilized.
 - ② Check the difference between the setting temperature and that in furnace (temperature of sample).
 - ③ Press the SUBMENU key. Select the character "cAL", which indicates the calibration offset, using the "▲▼", and then press the ENTER key.
 - ④ Input the difference using the "▲▼" and then press the ENTER key. This completes the setting.
- ❖ The setting range of offset correction temperature is +99°C to plus side and -99°C to minus side respectively.
When it is set to the minus side, the temperature on the measurement temperature display screen falls by the setting temperature, while the temperature on furnace rises.
When it is set to the plus side, the temperature on the measurement temperature display screen rises by the setting temperature, while the temperature on furnace falls.
 - ❖ The unit has two-point correction function, which performs offset between low-temperature zone and high-temperature zone. Please consult our local branch office when carrying out validation of temperature controller.

Use lock function

This function locks the operation status previously set. The function can be set or cancelled by the SUBMENU key.

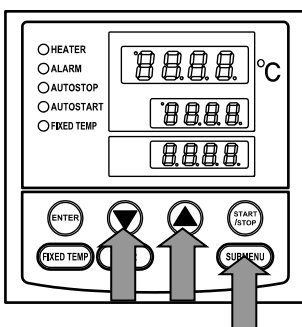

- ① Press the SUBMENU key. Select the character "Lock", which indicates the lock of setting value, using the "▲▼", and then press the ENTER key.
 - ② The setting temperature screen displays "oFF". The setting value is locked when it is turned to "o n" using the "▲".
 - ③ Press the SUBMENU key again to cancel the lock. Select the character "Lock", which indicates the lock of setting value, using the "▲▼", and then press the ENTER key. Select "oFF" with the "▼" and then press the ENTER key to cancel the function.
- ❖ All keys other than the START/STOP and SUBMENU keys are lock when the lock function is on.

WARNING!

If a problem occurs

-  If smoke or strange odor should come out of this unit for some reason, turn off the power key right away, and then turn off the circuit breaker and the main power. Immediately contact a service technician for inspection. If this procedure is not followed, fire or electrical shock may result. Never perform repair work yourself, since it is dangerous and not recommended.

Substances that cannot be used

-  Never use explosive substances, flammable substances and substances that include explosive or flammable ingredients in this unit. Explosion or fire may occur. (Refer to page31 "List of Dangerous Substances".)

CAUTION!

Do not step on this unit

-  Do not step on this unit. It will cause injury if this unit fall down or break.

Do not put anything on this unit

-  Do not put anything on this unit. It will cause injury if fall.

During a thunder storm

-  During a thunderstorm, turn off the power key immediately, then turn off the circuit breaker and the main power. If this procedure is not followed, fire or electrical shock may be caused.

Clean this unit with enough

-  Though this unit is cleaned beforehand, clean it with enough after leaving for a long period or when using it for the first time.

Water to be applied

-  Do not use the water including other liquids. The recommended water to be applied is, if possible, either ion exchange water or distilled water, and purify the water sometimes. When applying the ground water or tap water, a fur or dirt might be accumulated, and also might affect (descend) the heater efficiency or heater life. Purify water as required.

Water supply

-  When supplying water, pay attention not to spill water from the water bath or spread over the water bath. Should be spread a water over the operation panel, wipe it off completely. Failure to do so could cause the electric leakage or electric shock.

Countermeasure for stop operation during night or long-term stop

-  In case of stopping operation during night or long-term, toggle the power switch (earth leakage breaker) to "OFF".

CAUTION!

Unattended continuous operation



In case of performing unattended continuous operation, pay attention to the auto supplying water device (non-operation device, Level Controller (OBF10 Model) product code: 221570) for not heating with empty status.

Pay attention not to heat empty bath. (Overheating prevention device performance)



Do not operate this unit with empty water bath or with its heater spilled the water from. The heater might be red hot, the heater life descends seriously. What is worse, it could cause a fire. Be sure to check the water amount of the water bath before the operation, and supply water as required.

This unit has the overheating prevention device in itself, and goes off the electricity in case of occurring the heating of empty bath. Please contact to Yamato Science Service Office if the heating of empty bath is occurred.

Return after power failure



When power is supplied after a power failure, the device automatically starts operation again with the same state as just before the power failure. It is danger that the device starts unattached operation after a power failure. We recommend for you to turn off the switch of this unit if a power failure occurs during operation.

Daily Inspection and Maintenance

For the safety use of this unit, please perform the daily inspection and maintenance without fail. Using the city water to this unit might attach dirt. Do inspect and maintain this point while performing daily inspection and maintenance.

WARNING!

- Disconnect the power cable from the power source when doing an inspection or maintenance unless needed.
- Perform the daily inspection and maintenance after returning the temperature of this unit to the normal one. (Be sure to check the water in the test bath is cooled down.)
- Do not disassemble this unit.

CAUTION!

- Use a well-drained soft cloth to wipe dirt on this unit. Do not use benzene, thinner or cleanser for wiping. Do not scrub this unit. Deformation, deterioration or color change may result in.

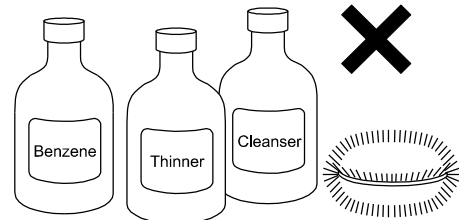

Monthly maintenance

- Check the earth leakage breaker function.
 1. Connect the power cord.
 2. Turn the breaker on.
 3. Push the red test switch by a ballpoint pen etc.
 4. If there is no problem, the earth leakage breaker will be turned off.

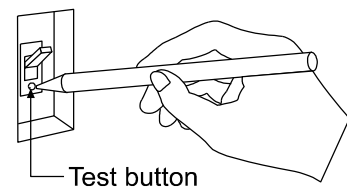

Water bath maintenance

- The density of the water in the water bath is concentrated gradually, and dirt might be attached and accumulated. If a fur or dirt is attached or accumulated, dip the water out of the water bath, and clean it completely.

Hose replacement

- For using this unit with stability, replace the hose once per two year as a guide. Please ask Yamato Scientific to the hose replacement.

For any questions, contact the dealer who you purchased this unit from, or the nearest sales division in our company.

When not using this unit for long term / When disposing

CAUTION!

When not using this unit for long term...

- Turn off the power and disconnect the power cord.

WARNING!

When disposing...

- Keep out of reach of children.
- Remove the door.
- Treat as large trash.

Environmental protection should be considered

We request you to disassemble this unit as possible and recycle the reusable parts considering to the environmental protection. The feature components of this unit and materials used are listed below.

Component Name	Material
Exterior Parts	
Outer covering	Steel plate
Bath	Stainless steel SUS304
Inspection window	Semi-tempered glass
Pole support	Aluminum die cast
Production plates	Polyethylene (PET) resin film
Operation unit frame, Corner	Alkylbenzenesulfied (ABS) resin
Fancy rubber, Rubber board	Chloroprene rubber
Electrical Parts	
Switch, Relays	Resin, Copper, Other composites
Board	Glass fiber, Other composites
Pipe heater	Copper
Power cord	Composites with synthetic rubber, Copper, Nickel
Parts for Piping	
Hoses	Ethylene Propylene Rubber (EPR)
Drain hose	Cone hose
Hose clamp	66 Nylon
Drain cap	Juracon
Options	
Connector	Aluminum die cast
Flask clipper	Aluminum die cast
Pole	SUS304

Error Display

This unit has an automatic diagnosis function built in the controller and safety devices independent of the controller. The table below shows the cause and the solution method when the safety device operates.

Error Code:

When an abnormal condition occurs, an error code appears and the alarm lamp lights in the controller, the buzzer sounds simultaneously. Record the error code and turn off the power of device immediately.

Safety Device	Notify	Cause/Solution
Sensor trouble detection	“ALARM” lamp lights on, “Er.01” appears	<ul style="list-style-type: none"> Temperature sensor is broken or disconnected. Make a call for service.
SSR short-circuit detection	“ALARM” lamp lights on, “Er.02” appears	<ul style="list-style-type: none"> Triac is in short-circuit Make a call for service.
Heater disconnecting detection	“ALARM” lamp lights on, “Er.03” appears	<ul style="list-style-type: none"> Heater is disconnected. Make a call for service.
Memory error	“ALARM” lamp lights on, “Er.15” appears	<ul style="list-style-type: none"> Failure in internal memory. Make a call for service.
Internal communication error	“ALARM” lamp lights on, “Er.17” appears	<ul style="list-style-type: none"> Failure in internal communication or temperature inputting circuit. Make a call for service.
Overheating	“ALARM” lamp lights on, “Er.19” appears	<ul style="list-style-type: none"> Overheating prevention device is in operation. Reset the power supply, and then adjust the setting temperature of the overheating protection device. If the state does not recover, make a call for service.
Measurement temperature error	“ALARM” lamp lights on, “----” appears	<ul style="list-style-type: none"> Measurement value is out of display range. Make a call for service.

Trouble Shooting

Condition	Possible Causes
The device does not start when turning on the power switch.	<ul style="list-style-type: none">• Power source is turned off.• Power failure.
Alarm lamp lights on.	<ul style="list-style-type: none">• Setting value of overheating prevention is lower than that of in-bath temperature.
Temperature does not rise.	<ul style="list-style-type: none">• The setting temperature is lower than that of in-bath temperature.

When power failure occurs...

- When power is supplied after a power failure, the device automatically starts operation again with the same state as just before the power failure. It is danger that the device starts unattached operation after a power failure.
- We recommend for you to turn off the switch of device if a power failure occurs during operation.

In the case if the error other than listed above occurred, turn off the power switch and primary power source immediately. Contact the shop of your purchase or nearest Yamato Scientific Service Office.

In Case of Request for Repair

If the failure occurs, stop the operation, turn OFF the power switch, and unplug the power plug. Please contact the sales agency that this unit was purchased, or the Yamato Scientific's sales office.

< Check following items before contact >

- ◆ Model Name of Product
 - ◆ Production Number
 - ◆ Purchase Date
 - ◆ About Trouble (in detail as possible)
- } See the production plate attached to this unit.

Minimum Retention Period of Performance Parts for Repair

The minimum retention period of performance parts for repair of this unit is 7 years after discontinuance of this unit.

The "performance part for repair" is the part that is required to maintain this unit.

Specification

	BK300	BK400	BK500	BK610	BK710
Operating temperature range	Ambient temp + 5 to 80°C				
Temperature adjustment accuracy	±0.02~±0.07°C				
Temperature distribution accuracy	±0.1°C				
Time required to reach highest temperature	Approx. 120min.	Approx. 110min.	Approx. 165min.	Approx. 160min.	Approx. 200min.
In-bath material	Stainless steel SUS304, Glass				
Temperature control system	PID control by microcomputer				
Sensor	Platinum resistance bulb (Pt 100Ω)				
Temperature setting system	Digital setting				
Temperature display system	Digital display				
Overheating prevention setting system	Digital setting				
Overheating prevention sensor	K-thermocouple (W-sensor with Pt 100Ω)				
Heater	Copper pipe heater (Nickel plated)				
	1.3KW	2.2KW	2.4KW	3.5KW	4.5KW
Stirrer	Magnet pump				
	6W	30W	30W	60W	
Timer	1 minute to 99 hours 59 minutes, and 100 hours to 999 hours Digital setting, Auto start and auto stop function				
Safety device	Earth leakage breaker, Overheating prevention device, Self-diagnostic functions (heater disconnection, TRIAC short circuit, overheat prevention)				
Internal dimensions (WxDxH mm)	300x300x300	400x350x300	500x400x350	548x500x400	640x500x450
External dimensions (WxDxH mm)	490x360x367	590x410x367	690x460x417	738x560x467	830x560x517
Inspection window dimensions	240x215	340x215	440x265	340x215	440x265
In-bath capacity	Approx. 27L	Approx. 42L	Approx. 70L	Approx. 109L	Approx. 144L
Drain hose size	φ15×20				
Power supply (50/60Hz)	115V AC			220V AC single phase	
	11.5A	20A	21A	16A	20.5A
Weight	Approx. 19Kg	Approx. 25Kg	Approx. 30Kg	Approx. 36Kg	Approx. 46Kg
Accessories	Shelf:1, Clamp:2, Stand:1, Clamp folder:2, Instruction manual				

Optional Accessories	Product code			
	Rack for vessels	Lid	Viscosity meter support	Cooling pipe
BK300	221195	221192	221189	221182
BK400	221196	221193	221183	
BK500	221197	221194	221184	
BK610	-	200000	-	-
BK710	-		-	-

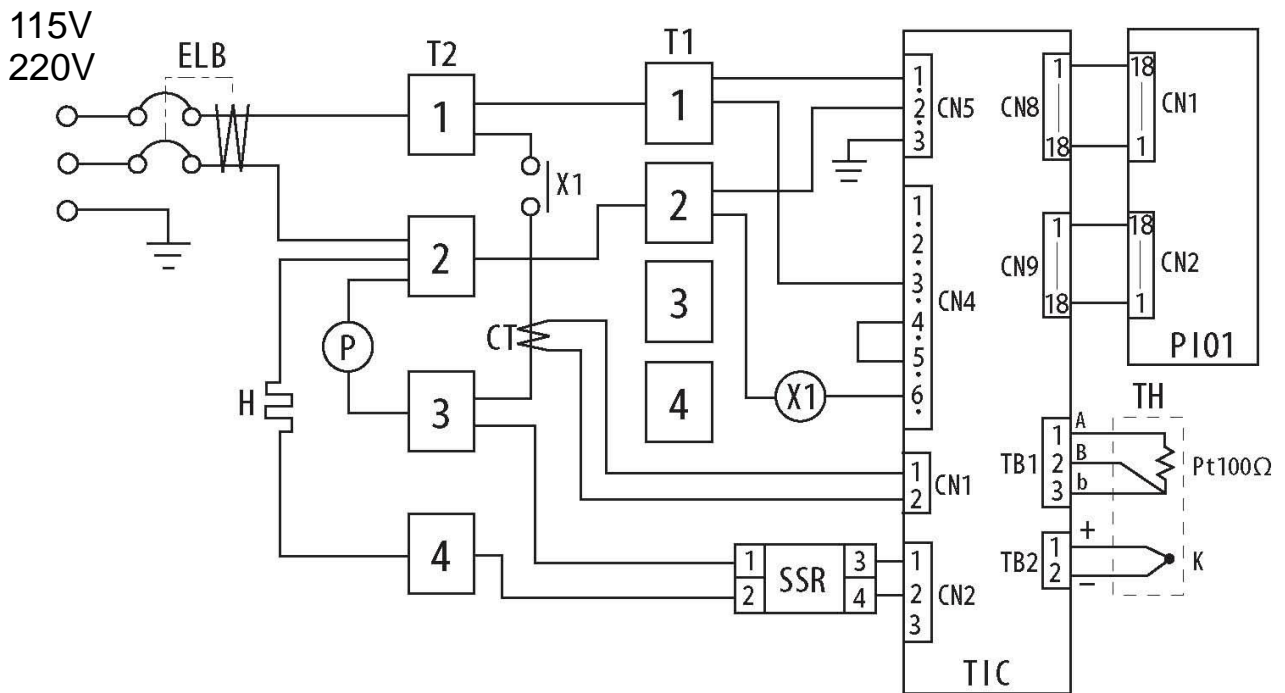

Symbol	Part name
ELB	Earth leakage breaker
T1,T2	Terminal blocks
TIC	Motherboard
PIO1	Display circuit board
X1	Relay
CT	Current transformer
SSR	Solid state relay
H	Heater
TH	Double sensor
P	Circulation pump
TF	Transformer

Replacement Parts Table

Common Use Parts

Part Name	Code No.	Specification	Manufacturer
W-sensor	1160030047	K-thermocouple φ4.8L×125L PT1/8	Yamato Scientific
VS type thermoregulator board	1020000052	VS-3, PIO, PLANAR, Two tough cards	Yamato Scientific
Current transform cell	2170010005	CTL-6-S-H	URD
Terminal block	LT00004736	ATK-20-4P	TOGI

BK300

Pipe heater		NMNi1-a3 115V 1.3KW	Yamato Scientific
Magnet pump		MD-10A 115V	Iwaki
Relay	LT00005140	AHE1274 100V	Matsushita
SSR	2160000035	TRS5225	Toho Denshi
Earth leakage breaker	DN104	BJS153	Matsushita

BK400

Pipe heater		NMNi1-a3 115V 2.2KW	Yamato Scientific
Magnet pump		MD-20R-N 115V	Iwaki
Relay	LT00005140	AHE1274 100V	Matsushita
SSR	2160000036	TRS1225	Toho Denshi
Earth leakage breaker	2060050003	BJS303	Matsushita

BK500

Pipe heater		NMNi1-a3 115V 2.4KW	Yamato Scientific
Magnet pump		MD-30R-N 115V	Iwaki
Relay	LT00005140	AHE1274 100V	Matsushita
SSR	2160000036	TRS1225	Toho Denshi
Earth leakage breaker	2060050003	BJS303	Matsushita

BK610

Pipe heater	BK610-40020	NMNi1-a3 200V 3.5KW	Yamato Scientific
Magnet pump	2150070003	MD-40R-200N 220V	Iwaki
Relay	2050000059	AHE1275 200V	Matsushita
SSR	2160000036	TRS1225	Toho Denshi
Earth leakage breaker	2060050002	BJS203	Matsushita

BK710

Pipe heater	BK710-40020	NMNi1-a3 200V 4.5KW	Yamato Scientific
Magnet pump	2150070003	MD-40R-200N 220V	Iwaki
Relay	2050000059	AHE1275 200V	Matsushita
SSR	2160000036	TRS1225	Toho Denshi
Earth leakage breaker	2060050003	BJS303	Matsushita

List of Dangerous Substances



Never use explosive substances, flammable substances and substances that include explosive or flammable ingredients in this unit.

EXPLOSIVE

EXPLOSIVE:	Ethylene glycol dinitrate (nitro glycol), Glycerin trinitrate (nitroglycerine), Cellulose nitrate (nitrocellulose), and other explosive nitrate esters
	Trinitrobenzene, Trinitrotoluene, Trinitrophenol (picric acid), and other explosive nitro compounds
	Acetyl hidroperoxide (peracetic acid), Methyl ethyl ketone peroxide, Benzyl peroxide, and other organic peroxides

FLAMMABLE

IGNITING:	Lithium (metal), Potassium (metal), Sodium (metal), Yellow phosphorus, Phosphorus sulfide, Red phosphorus, Celluloid compounds, Calcium carbide, Lime phosphate, Magnesium (powder), Aluminum (powder), Powder of metals other than magnesium and aluminum, Sodium hydrosulfite
OXIDIZING:	Potassium chlorate, Sodium chlorate, Ammonium chlorate, and other chlorate
	Potassium perchlorate, Sodium perchlorate, Ammonium perchlorate, and other perchlorate
	Potassium peroxide, Sodium peroxide, Barium peroxide, and other inorganic peroxide
	Potassium nitrate, Sodium nitrate, Ammonium nitrate, and other nitrate
	Sodium chlorite and other chlorites
	Calcium hypochlorite and other hypochlorites
INFLAMMABLE LIQUID:	Ethyl ether, Gasoline, Acetaldehyde, Propylene chloride, Carbon disulfide, and other flammable substances having a flash point of lower than -30°C
	Normal hexane, ethylene oxide, acetone, benzene, methyl ethyl ketone, and other flammable substances having a flash point of -30°C or higher but lower than 0°C
	Methanol, Ethanol, Xylene, Pentyl acetate (amyl acetate), and other flammable substances having a flash point of 0°C or higher but lower than 30°C
	Kerosene, Light oil (gas oil), Oil of turpentine, Isopentyl alcohol (isoamyl alcohol), Acetic acid, and other flammable substances having a flash point of 30°C or higher but lower than 65°C
FLAMMABLE GAS:	Hydrogen, Acetylene, Ethylene, Methane, Propane, Butane, and other flammable substances which assume a gaseous state at 15°C and 1 atm

(Source: Appendix Table 1 of Article 6 of the Industrial Safety and Health Order in Japan)

Responsibility

Please follow the instructions in this document when using this unit. Yamato Scientific has no responsibility for the accidents or breakdown of device if it is used with a failure to comply. Never conduct what this document forbids. Unexpected accidents or breakdown may result in.

Note

- ◆ The contents of this document may be changed in future without notice.
- ◆ Any books with missing pages or disorderly binding may be replaced.

Instruction Manual for
Constant Temperature Water Bath
Model BK300/400/500/610/710

First Edition July 12, 2016
Revised February 10, 2017

Yamato Scientific America, Inc.

925 Walsh Avenue, Santa Clara,
CA 95050, U.S.A

<http://www.yamato-usa.com>

Toll Free: 1-800-2-YAMATO(1-800-292-6286)