

INSTRUCTION MANUAL

BK PRECISION

1520

20 MHz, TRIGGERED SWEEP

Dual-Trace Oscilloscope

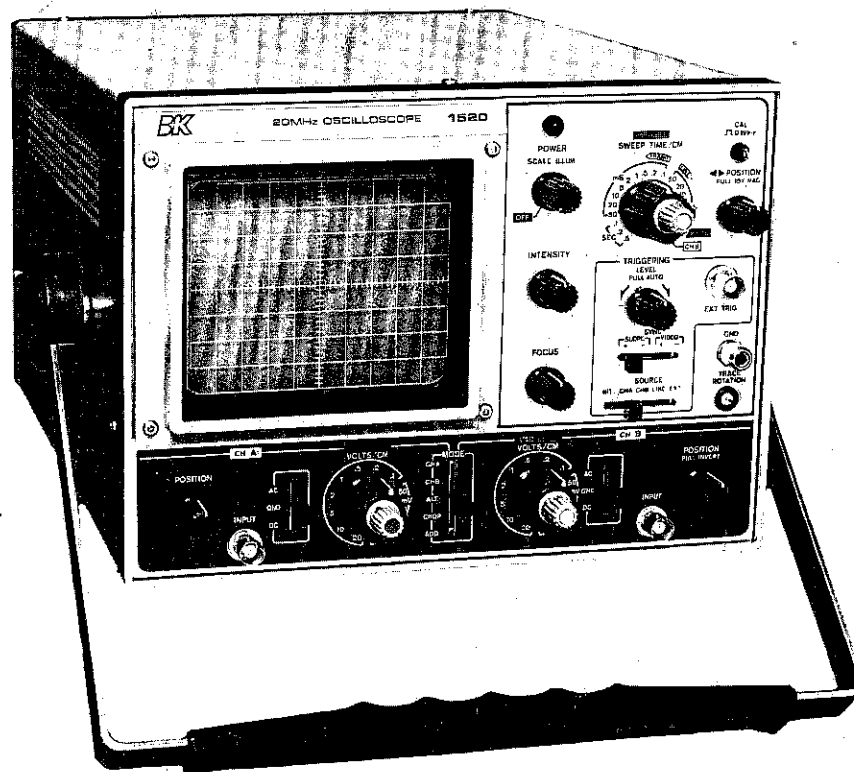

BK PRECISION

**DYNASCAN
CORPORATION**

INSTRUCTION MANUAL
FOR
B & K-PRECISION
MODEL 1520
20 MHz, TRIGGERED SWEEP
DUAL-TRACE OSCILLOSCOPE

B+K PRECISION DYNASCAN
CORPORATION

6460 West Cortland Street
Chicago, Illinois 60635

TABLE OF CONTENTS

	Page
INTRODUCTION	4
FEATURES	4
SPECIFICATIONS	6
OPERATOR'S CONTROLS, INDICATORS AND FACILITIES	9
OPTIONAL ACCESSORIES	11
OPERATING INSTRUCTIONS	
Initial Starting Procedure	12
Waveform Observation	12
Triggering	13
Calibrated Voltage Measurement	15
Differential Voltage Measurement	16
Calibrated Time Measurement	17
External Horizontal Input (X-Y Operation)	18
Z-Axis Input	18
DUAL-TRACE APPLICATIONS	
Introduction	19
Frequency Divider Waveforms	19
Divide-by-8 Circuit Waveforms	19
Propagation Time Measurement	20
Digital Circuit Time Relationships	20
Distortion Measurement	21
Delay Line Tests	22
Improving the Ratio of Desired-to-Undesired Signals	22
VIDEO PRODUCT SERVICING APPLICATIONS	
General	23
Composite Video Waveform Analysis	23
VITS (Vertical Interval Test Signal and VIR (Vertical Interval Reference)	24
Television Alignment	26
Vectorscope Operation	27

TABLE OF CONTENTS

	Page
CB RADIO APPLICATIONS	
Introduction	29
Transmitter Modulation	29
Other CB Measurements	29
COMMUNICATIONS RADIO APPLICATIONS	31
STEREO AMPLIFIER SERVICING	31
AMPLIFIER PHASE SHIFT MEASUREMENTS	31
FREQUENCY MEASUREMENT	33
SQUARE WAVE TESTING OF AMPLIFIERS	33
MAINTENANCE AND CALIBRATION	
Removing the Case	35
Fuse Replacement	35
120/240 Volt Conversion	35
Basic Troubleshooting Checklist	36
Periodic Adjustments	36
Calibration Check	38
Calibration Adjustments	38
WARRANTY SERVICE INSTRUCTIONS	40
ONE YEAR LIMITED WARRANTY	40

INTRODUCTION

The **B & K-PRECISION** Model 1520 Dual-Trace Oscilloscope is a high-performance, laboratory-quality instrument. Its performance, versatility, and operational features are designed to meet the needs of engineers and other advanced technologists in electronic research and design laboratories, test and analysis centers, and well-equipped service shops. The instrument is built for the professional who understands how to use scopes, with many operating conditions selected manually rather than automatically to permit greater versatility. For example, in dual-trace operation the sweep can be triggered by the CH A, CH B, LINE, or EXT signal, as manually selected by the user.

Performance features include DC to 20 MHz bandwidth (-3 dB) with smooth rolloff above 20 MHz to allow operation beyond 30 MHz, high sensitivity (5 mV/cm), and calibration precision. Matched, dual vertical inputs permit

simultaneous viewing of two waveforms. Chop or alternate sweep operation is manually selected. Add and subtract capability is also provided so that the sum or difference of two waveforms can be displayed as a single trace. The Channel B vertical input can be switched to become the horizontal input during X-Y operation; sensitivity of the horizontal axis equals that of the vertical axis.

For video applications such as video tape recorders, CATV and MATV networks, and television receivers, a built-in sync separator permits viewing of composite video waveforms. Vectorscope operation is provided for analyzing color circuits.

Features like 10X magnification, electrical trace rotation (adjustable from the front panel), a slotted bezel for mounting a standard oscilloscope camera and the crisp, clean, modern styling will also be found.

FEATURES

DUAL TRACE

Two input waveforms can be viewed either singly or simultaneously, as desired. Individual vertical sensitivity and positioning controls are provided for completely independent adjustment of the two signal amplitudes. Choice of ALternate sweep or 200 kHz CHOP mode for dual-trace operation.

FULLY SOLID STATE

Only the cathode ray tube uses a filament.

20 MHz BANDWIDTH

DC to 20 MHz bandwidth and 17.5 nS rise time assure distortion-free, high-resolution presentation at high frequencies. Smooth roll-off makes scope usable well above 20 MHz. Distortion-free display of signals up to 20 MHz on full area of the CRT screen.

HIGH SENSITIVITY (5 mV/div.)

Permits the low-capacitance, high-impedance, 10:1 attenuation probes to be used for virtually all measurements, thus assuring minimum circuit loading.

DIGITAL LOGIC APPLICATIONS

Design, analysis and troubleshooting of mini-computers, microprocessors, computer terminals, electronic organs, calculators, and most digital logic circuitry using TTL, CMOS, and most ECL logic.

VIDEO APPLICATIONS

Development, testing, and servicing of video equipment including VTRs (video tape recorders), CATV (cable television), MATV (master television antenna networks), and television receivers. A built-in sync separator circuit is

included specifically for viewing composite video signals. Vertical sync pulses are automatically selected at sweep speeds appropriate for viewing television frames, and horizontal sync pulses are automatically selected at sweep speeds appropriate for viewing television lines.

RADIO APPLICATIONS

Development, manufacturing, and servicing of CB radios and communications radios to 30 MHz. Direct RF and IF measurements, AM and SSB modulation patterns, digital data transmission.

12 CALIBRATED VOLTAGE SCALES

Accurate measurement of instantaneous voltages on 12 different attenuator ranges for both Channel A and Channel B (5 mV/div. to 20 V/div.).

TRIGGERED SWEEP

Fully adjustable trigger threshold allows the desired portion of the waveforms to be used for triggering. When AUTO sweep is selected, sweep is generated with or without input signal.

5 SYNC SOURCES

Choice of INTERNAL, CH A, CH B, LINE, or EXTERNAL sync. Each source has choice of + or - slope, or + or - polarity video sync pulse.

19 CALIBRATED SWEEP SPEEDS

Accurate time measurements on 19 different ranges.

Sweep speed range of 0.5 μ S/div. to 0.5 S/div. provides every speed necessary for viewing waveforms from DC to 20 MHz.

**10X
MAGNIFICATION**

A ten times (10X) magnification of the horizontal sweep allows close-up examination of any portion of the waveform. In addition, the 10X magnification provides a maximum sweep speed of 50 nS/div.

**CALIBRATION
SOURCE**

A built-in, calibrated, 0.1-volt peak-to-peak square wave permits checking and recalibration of the vertical amplifiers without additional equipment.

**SUM AND
DIFFERENCE
CAPABILITY**

Permits algebraically adding or subtracting Channel A and Channel B and display as a single trace. Useful for differential voltage and distortion measurements.

X-Y OPERATION

Channel B input can be applied as horizontal deflection (X axis) while Channel A input provides vertical deflection (Y axis). Horizontal axis sensitivity is 5 mV/div.

**Z-AXIS
INPUT**

Intensity modulation capability included for time or frequency markers, compatible with 5V p-p solid state logic circuits.

**ELECTRICAL
TRACE ROTATION**

Trace rotation is electrically adjustable from the front panel.

**REGULATED POWER
SUPPLY**

All voltages are regulated, including the high voltage for the CRT, assuring that brightness and sensitivity are unaffected by line voltage variations.

**BRIGHT
PHOSPHOR**

Bright blue P31 phosphor, usually found only in more expensive oscilloscopes.

LARGE SCREEN

The 130 mm (approx. 5.1 inches) diameter cathode ray tube gives easy-to-read presentation on an 8 x 10 cm rectangular viewing area.

**ILLUMINATED
SCALE**

Fully variable illumination for the scale. Vertical and horizontal markers on the scale make voltage and time measurements easy to read.

SPECIFICATIONS

VERTICAL AMPLIFIERS (CH A and CH B)

Deflection Factor	5 mV/cm to 20 V/cm, $\pm 5\%$, in 12 ranges — with vernier for fine adjustment.
Frequency Response	DC: DC to 20 MHz (-3 dB). AC: 2 Hz to 20 MHz (-3 dB).
Risetime	17.5 nanoseconds or less.
Overshoot	3% or less (at 100 kHz square wave).
Input Impedance	1 megohm, $\pm 2\%$, shunted by 27 pF (± 3 pF).
Max. Input Voltage	300 V (DC + AC peak) or 600 V p-p.
Operating Modes	Channel A only. Channel B only. Chop (dual trace). Alternate (dual trace). Add: Single-trace algebraic <i>sum</i> of Channels A and B. (Single-trace algebraic <i>difference</i> of Channels A and B when Channel B signal is inverted).
Chop Frequency	200 kHz ($\pm 20\%$).
Channel Separation	Better than 70 dB @ 1 kHz.
Channel B Polarity	Normal or inverted.
Maximum Undistorted Amplitude	More than 8 cm, DC to 20 MHz.

SWEEP CIRCUITS (Common to CH A and CH B)

Sweep System	Triggered and automatic. In automatic mode, sweep is obtained without input signal.
Sweep Time	0.5 μ S/cm to 0.5 S/cm (5%) in 19 ranges, in 1-2-5 sequence. Each overlapping range provides for fine adjustment.
Magnifier	X10, $\pm 5\%$.
Linearity	3% or less distortion, 0.5 S/cm to 2 μ S/cm ranges; 5% or less for 1 μ S/cm and 0.5 μ S/cm ranges, 10% or less for X10 magnification.

TRIGGERING

Source	INTernal Channel A trigger in CH A mode. Channel B trigger in CH B mode. Channel A trigger in DUAL and ADD modes. CH A. Channel A trigger regardless of mode. CH B. Channel B trigger regardless of mode. LINE. Power line frequency (60 Hz in USA). EXTernal. Normal, automatic. In automatic mode, the sweep triggers automatically without an input signal.
Type	
Slope	Positive or negative, continuously variable level control; pull for adjustable level AUTO.
Video Sync	Vertical and horizontal sync separator circuit provided so that any portion of composite video waveform can be synchronized and expanded for viewing. LINE (horizontal sync pulses) and FRAME (vertical sync pulses) selected automatically by SWEEP TIME/CM switch.
Sensitivity	

Trigger Type	Bandwidth	Minimum Sync Voltage	
		INT	EXT
NOR	50 Hz — 15 MHz	0.5 cm	0.5 V p-p
	20 Hz — 20 MHz	1.0 cm	1.0 V p-p
AUTO	50 Hz — 15 MHz	0.5 cm	0.5 V p-p
	20 Hz — 20 MHz	1.0 cm	1.0 V p-p
VIDEO	Video Signal	1.0 cm	1.0 V p-p

Maximum External Trigger 50 V (DC + AC peak).

HORIZONTAL AMPLIFIER (Horizontal input thru CH B input)

Deflection Factor	5 mV/cm to 20 V/cm $\pm 5\%$.
Frequency Response	DC: DC to 2 MHz (-3 dB). AC: 2 Hz to 2 MHz (-3 dB).
Input Impedance	1 megohm, $\pm 2\%$, shunted by 27 pF (± 3 pF).
Input Protection	300 V (DC + AC peak) or 600 V p-p.
X-Y Operation	With SWEEP TIME/CM switch in CH B position, the CH A input becomes the Y-axis input (vertical) and the CH B input becomes the X-axis input (horizontal). The CH B position control become the horizontal position control.
X-Y Phase Difference	3° or less at 70 kHz.

CALIBRATION VOLTAGE

1 kHz square wave of 0.1 V p-p ($\pm 3\%$).

INTENSITY MODULATION

Input Voltage	Less than 5 V p-p, TTL compatible. Positive voltage increase brightness, zero voltage decreases brightness.
Bandwidth	DC - 5 MHz.
Input Impedance	15 Kohms $\pm 20\%$.
Maximum Input Voltage	50 V (DC + AC peak).

POWER REQUIREMENTS

AC	100/120/220/240 V, $\pm 10\%$; 50/60 Hz; 47 watts.
----	---

MISCELLANEOUS

Trace Rotation	Electrical, adjustable from front panel.
Scale	8 x 10 division; 1 division = 1 cm. Variable illumination.
CRT	130 mm diameter (approx 5").
Acceleration Voltage	2 kV.
Mechanical Features	Combination carrying handle/tilt stand.
Dimensions, Case (WxHxD)	25.8 x 18.8 x 35.3 cm. (10-1/8 x 7-3/8 x 13-7/8").
Dimensions, Maximum (WxHxD)	29.9 x 20.4 x 38.5 cm. (11 3/4 x 8 x 15-1/8").

Weight 9 kg (20 lb.).

PROBES (TWO REQUIRED)

Model Nos.	PR-36, PR-37.
Attenuation	Combination 10:1 and direct.
Input Impedance	10.1 = 10 Megohms, 18 pF. Direct = 1 Megohm, 120 pF (PR-37 = 40 pF).
Connector	BNC male.
Frequency Response	PR-36 = 50 MHz. PR-37 = 100 MHz.

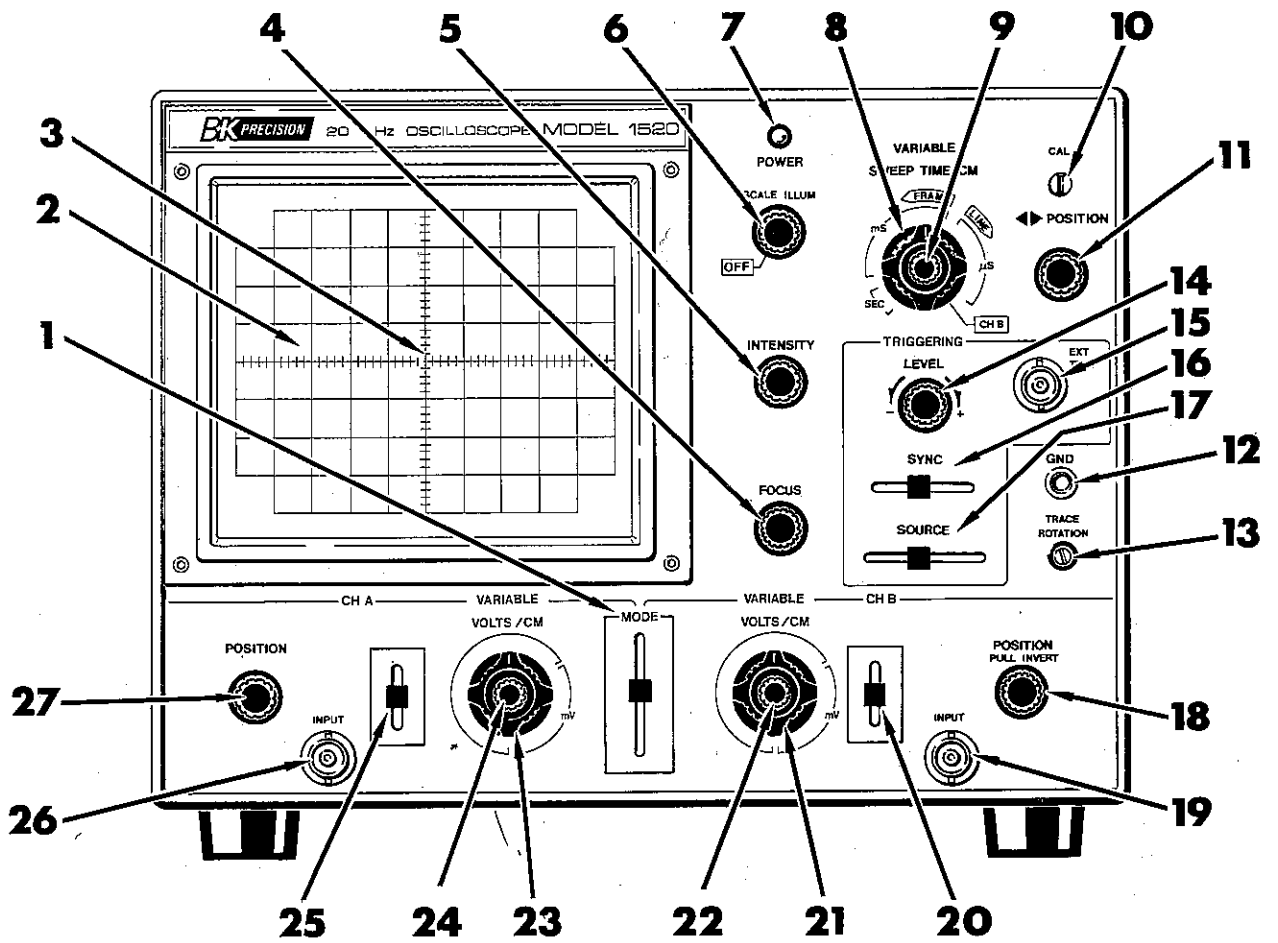



Fig. 1. Front panel controls and indicators.

OPERATOR'S CONTROLS, INDICATORS AND FACILITIES

(See Fig. 1)

GENERAL CONTROLS (1 - 13)

- 1. MODE Switch.** Five-position lever switch; selects the basic operating modes of the oscilloscope.
 - CH A** Only the input signal to Channel A is displayed as a single trace.
 - CH B** Only the input signal to Channel B is displayed as a single trace.
 - ALT** Dual-trace operation, in which sweep alternately displays Channel A, then Channel B, input signal. Recommended for sweep times of .5 mS/cm to .5 μ S/cm.
 - CHOP** Dual-trace operation in which sweep is chopped at approximate 200 kHz rate and switched between Channel A and Channel B traces. Recommended for sweep times of .5 S/cm to 1 mS/cm.
 - ADD** The waveforms from Channel A and Channel B inputs are added and the sum is displayed as a single trace. When the Channel B POSITION control is pulled (PULL INVERT), the waveform from Channel B is subtracted from the Channel A waveform and the difference is displayed as a single trace.
- 2. Cathode Ray Tube (CRT).** This is the screen on which the waveforms are viewed.
- 3. Scale.** This 8 x 10 cm graticule provides calibration marks for voltage (vertical) and time (horizontal) measurements. Illumination of the scale is fully adjustable.
- 4. FOCUS Control.**
- 5. INTENSITY Control.** Adjusts brightness of trace.
- 6. POWER ILLUM Control.** Fully counterclockwise rotation of this control (OFF position) turns off oscilloscope. Clockwise rotation turns on oscilloscope. Further clockwise rotation of the control increases the illumination level of the scale.
- 7. Pilot Light.** Glows when oscilloscope is turned on.
- 8. SWEEP TIME/CM Switch.** Horizontal coarse sweep time selector. Selects calibrated sweep times of 0.5 μ S/cm (microsecond per centimeter) to 0.5 S/cm in 19 steps when VARIABLE control (9) is set to the CAL position (fully clockwise). In the CH B position, this switch disables the internal sweep generator and permits the CH B input to provide horizontal deflection (X-Y operation). The Channel A input signal produces vertical deflection (Y axis) and the Channel B input signal produces horizontal deflection (X axis).
- 9. Sweep Speed VARIABLE Control.** Fine sweep time adjustment. In the extreme clockwise (CAL) position the sweep time is calibrated.

- 10. CAL  0.1 V p-p Terminal.** Provides calibrated 1 kHz, 0.1 volt peak-to-peak square wave input signal. This is used for calibration of the vertical amplifier attenuators and to check the frequency compensation adjustment of the probes used with the oscilloscope.
- 11.  POSITION Control.** Rotation adjusts horizontal position of traces (both traces when operated in the dual trace mode). Push-pull switch selects 10X magnification when pulled out (PULL 10X MAG); normal when pushed in.
- 12. GND Terminal/Binding Post.** Earth and chassis ground.
- 13. TRACE ROTATION Control.** Electrically rotates trace to horizontal position.

TRIGGERING CONTROLS (14-17)

- 14. LEVEL Control.** Sync level adjustment determines points on waveform slope where sweep starts; (-) equals most negative point of triggering and (+) equals most positive point of triggering. Push-pull switch selects automatic triggering when pulled out (PULL AUTO). When automatic triggering, a sweep is generated even without an input signal.
- 15. EXT TRIG Jack.** Input terminal for external trigger signal.
- 16. SYNC Switch.** Four-position lever switch with the following positions:
 - SLOPE.** The SLOPE positions are used for viewing all waveforms except television composite video signals.
 - (+) Sweep is triggered on positive-going slope of waveform.
 - (-) Sweep is triggered on negative-going slope of waveform.
 - VIDEO.** In the VIDEO positions, the sync pulses of a composite video signal are used to trigger the sweep; the vertical sync pulses (frame) are automatically selected for sweep times of 0.5 S/cm to 0.1 mS/cm, and horizontal sync pulses (line) are automatically selected for sweep times of 50 μ S/cm to .5 μ S/cm.
 - (+) Sweep is triggered on positive-going sync pulse.
 - (-) Sweep is triggered on negative-going sync pulse.
- 17. SOURCE Switch.** Five-position lever switch selects triggering source for sweep.
 - INT** In CH B mode, Channel B signal becomes trigger. In CH A, ALT, CHOP, and ADD mode, Channel A signal becomes trigger.
 - CH A** Channel A signal becomes trigger in all modes.
 - CH B** Channel B signal becomes trigger in all modes.

- LINE Line voltage (60 Hz in USA) becomes trigger.
- EXT Signal applied at EXT TRIG jack becomes trigger.

CHANNEL B CONTROLS (18-22)

- 18. **POSITION Control.** Vertical position adjustment for Channel B trace. Becomes horizontal position adjustment when SWEEP TIME/CM switch (8) is in the CH B position (X-Y operation).
- 19. **INPUT Jack.** Vertical input jack of Channel B. Jack becomes external horizontal input when SWEEP TIME/CM switch (8) is in the CH B position (X-Y operation).
- 20. **Channel B AC-GND-DC Switch.**
 - AC Blocks DC component of input signal.
 - GND Opens signal path and grounds input to vertical amplifier. This provides a zero-signal base line, the position of which can be used as a reference when performing DC measurements.
 - DC Direct input of AC and DC component of input signal.
- 21. **VOLTS/CM Switch.** Vertical attenuator for Channel B which provides step adjustment of vertical sensitivity. Vertical sensitivity is calibrated in 12 steps from 5 mV to 20 volts per cm when VARIABLE control (22) is set to CAL position. This control adjusts horizontal sensitivity when the SWEEP TIME/CM switch (8) is in the CH B position (X-Y operation).
- 22. **VARIABLE Control.** Vertical attenuator adjustment provides fine control of vertical sensitivity. In the extreme clockwise (CAL) position, the vertical attenuator is calibrated. This control becomes the fine horizontal gain control when the SWEEP TIME/CM switch (8) is in the CH B position.

CHANNEL A CONTROLS (23-27)

- 23. **VOLTS/CM Switch.** Vertical attenuator for Channel A which provides coarse adjustment of vertical sensitivity. Vertical sensitivity is calibrated in 12 steps from 5 mV to 20 volts per cm when VARIABLE control (24) is set to the CAL position.
- 24. **VARIABLE Control.** Vertical attenuator adjustment provides fine control of vertical sensitivity. In the extreme clockwise (CAL) position, the vertical attenuator is calibrated.
- 25. **Channel A AC-GND-DC Switch.**
 - AC Blocks DC component of input signal.
 - GND Opens signal path and ground input to vertical amplifier. This provides a zero-signal base line, the position of which can be used as a reference when performing DC measurement.
 - DC Direct input of AC and DC component of input signal.
- 26. **INPUT Jack.** Vertical input jack of Channel A.

- 27. **POSITION Control.** Vertical position adjustment for Channel A trace.

**ADDITIONAL FACILITIES
(Not shown in Fig. 1)**

- 28. **Z AXIS INPUT Jack** (mounted on rear panel). Intensity modulation input.
- 29. Carrying handle/tilt stand. Press in both pivot points to unlock and rotate handle. Will lock at each 22.5° angle of rotation.
- 30. Feet/cord wrap. Feet support oscilloscope in vertical position (face up) and serve as cord wrap for storing power cord.
- 31. Probes (two required).

The B & K-PRECISION Model PR-37 deluxe probe is designed for use with wideband oscilloscopes to 100 MHz. The PR-37 is a slim-body probe of precision lightweight construction. A three-position switch select 10:1 or direct modes, or a reference position that grounds the tip through a 9M resistor. The 52" coaxial cable is extremely flexible. Accessories included with the PR-37 are a spring-loaded retractable tip cover, insulating tip BNC tip adapter, IC tip and an insulated compensation capacitor adjustment tool. The insulating tip is designed for probing dense solid-state circuitry with no danger of shorting nearby components.

The BNC adapter tip converts the probe tip into a push-on BNC fitting, ideal for interface with test points or output jacks. The IC tip guides the probe contact into any pin of a standard DIP, making it almost impossible to short two pins of an IC. The PR-37 is available in both grey and red colors. Probes of different colors are particularly useful with a dual-trace scope for instant identification of the channel to which a probe is connected. The PR-37 and accessories come in convenient zippered vinyl case. Model PR-37G is grey and PR-37R is red.

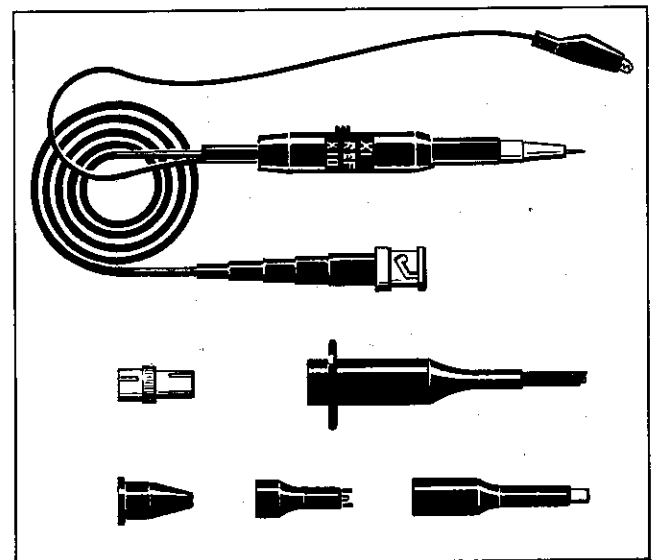

Fig. 2. PR-37 probe.

OPTIONAL ACCESSORIES

The following **B & K-PRECISION** accessories are available to complement your Model 1520 Oscilloscope.

MODEL LC-74 PROTECTIVE COVER

This rugged grained leatherette cover provides convenience and protection when transporting the oscilloscope. A handy pocket provides stowage for probes.

MODEL RM-14 RACK MOUNTING KIT

This kit includes everything needed to mount the oscilloscope in a standard 19" rack, including panel, hardware, and complete instructions.

INSTRUMENT CONNECTING CABLES

The following **B & K-PRECISION** cables, which may be purchased separately, may be useful for connecting your oscilloscope directly to other equipment:

Model CC-41. 36" RG/58U with a BNC connector on each end.

Model CC-42. 36" RG/58U with BNC connector and UHF connector (PL-259).

Model CC-43. 36" RG/58U with BNC connector and banana plugs.

Model CC-44. 36" RG/58U connector and coaxial microphone connector.

Model CC-45. 36" RG/58U with BNC connector and type N connector.

MODEL PR-32 RF DEMODULATOR PROBE

This probe permits display and analysis of the modulation envelope of RF signals to 250 MHz (-6 dB @ 250 MHz). Input impedance is 30 k Ω minimum, shunted by 4.5 pF maximum. Internal shielding protects against stray RF pickup.

OPERATING INSTRUCTIONS

CAUTION

1. Never allow a small spot of high brilliance to remain stationary on the screen for more than a few seconds. The screen may become permanently burned. Reduce intensity or keep the spot in motion by causing it to sweep.
2. Never cover the ventilating holes in the sides of the oscilloscope, as this will increase the operating temperature inside the case.

INITIAL STARTING PROCEDURE

1. Set POWER ILLUM control (6) to OFF position (fully counterclockwise).
2. Connect power cord to a 120-volt, 50/60 Hz outlet. Operation from 100 volts, 220 volts, or 240 volts, 50/60 Hz AC is also possible if the oscilloscope is first set up for such operation. Procedures are given in the MAINTENANCE AND CALIBRATION section of this manual.
3. Set CH A POSITION control (27), CH B POSITION control (18) and ◀ POSITION control (11) to the center of their ranges.
4. Pull TRIGGERING LEVEL control (14) to the AUTO position.
5. Set CH A AC-GND-DC switch (25) and CH B AC-GND-DC switch (20) to the GND positions.
6. Set the MODE switch (1) to the CH B position for single-trace operation or the ALT position for dual-trace operation.
7. Set the SWEEP TIME/CM switch (8) to the .1 mS position.
8. Set SOURCE switch (17) to INT position.
9. Turn on oscilloscope by rotating the POWER ILLUM control (6) clockwise. It will "click" on and pilot light (7) will glow. Turn control clockwise to the desired scale (3) illumination.
10. Wait a few seconds for the cathode ray tube (CRT) to warm up. A trace (two traces if operating in a dual-trace mode) should appear on the face of the CRT.
11. If no trace appears, increase (clockwise) the INTENSITY control (5) setting until the trace is easily observed.
12. Adjust FOCUS control (4) and INTENSITY control (5) for the thinnest, sharpest trace.
13. Readjust POSITION controls (11) (18) and (27) if necessary, to center the traces.

14. Check for proper adjustment of ASTIG control, and DC balance controls as described in the MAINTENANCE AND CALIBRATION portion of this manual. These adjustments require checking only periodically.

The oscilloscope is now ready for making waveform measurements.

WAVEFORM OBSERVATION

Single Trace

Either Channel A or Channel B can be used for single-trace operation. The advantage of using Channel B is that the polarity of the observed waveform can be reversed. For convenience, Channel B is used in the following instructions:

1. Perform the steps of the INITIAL STARTING PROCEDURE with the MODE switch (1) in the CH B position. Then connect the probe cable to the CH B INPUT jack (19).
2. For all except very low-amplitude waveforms, the probes are set for 10:1 attenuation. For very low-amplitude waveforms (below 100 millivolts peak-to-peak), set the probe for DIRECT. The 10:1 setting, with its higher input impedance and lower shunting capacitance, should be used when possible to decrease circuit loading.
3. Set CH B AC-GND-DC switch (20) to AC for measuring only the AC component (this is the normal position for most measurements and must be used if the point being measured includes a large DC component). Use the DC position for measuring both the AC component and the DC reference, and any time a very low frequency waveform (below 2 Hz) is to be observed. The GND position is required only when a zero-signal ground reference is required, such as for DC voltage readings.
4. Connect ground clip of probe to chassis ground of the equipment under test. Connect the tip of the probe to the point in the circuit where the waveform is to be measured.

WARNING

- a. If the equipment under test is a transformerless AC-powered item, use an isolation transfer to prevent dangerous electrical shock.
 - b. The peak-to-peak voltage at the point of measurement should not exceed 600 volts.
5. Set CH B VOLTS/CM switch (21) and the VARIABLE control (22) to a position that gives 2 to 6 divisions of vertical deflection. The display on the screen will probably be unsynchronized. Refer to TRIGGERING procedures below for adjusting synchronization and sweep speed to obtain a stable display showing the desired number of waveforms.

Dual Trace (Refer to Fig. 3)

In observing simultaneous waveforms on Channels A and B, it is necessary that the waveforms be related in frequency or that one of the waveforms be synchronized to the other, although the basic frequencies may be different. Example: checking a frequency divider or multiplier. The reference, or "clock" frequency can be used on Channel A, for example, and the multiple or sub-multiple of this reference frequency will be displayed on Channel B. In this way, when the waveform display of Channel A is synchronized, the display on Channel B also will be in sync with the Channel A display. If two waveforms having no phase or frequency relationships to each other are displayed simultaneously, it will be difficult if not impossible to lock both waveforms in sync for any useful observation.

To display two waveforms simultaneously for observation, use the following procedure.

1. Perform the steps of the INITIAL STARTING PROCEDURE.
2. Connect oscilloscope probe cables to both the CH A and CH B INPUT jacks (19 and 26).

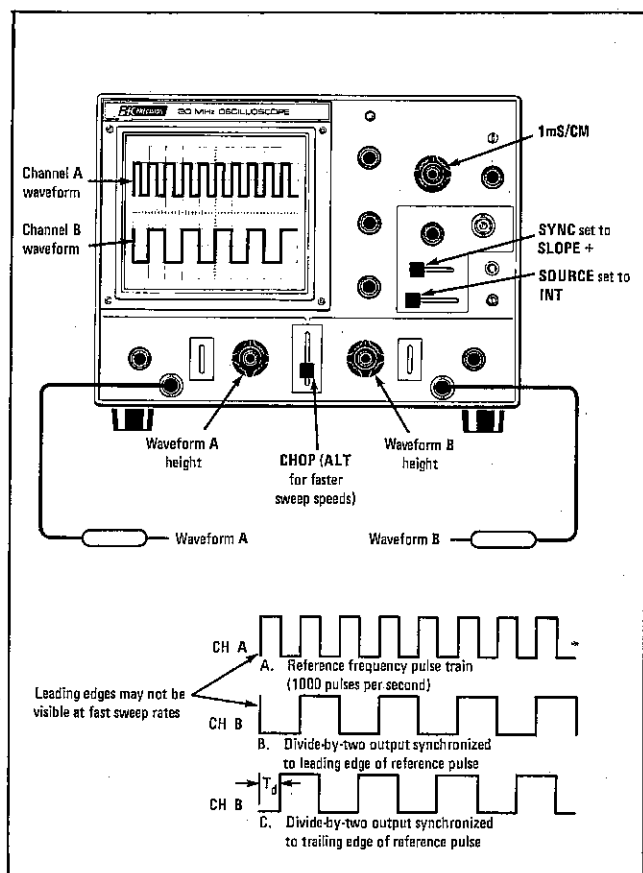

Fig. 3. Dual-trace waveform observation in divide-by-two digital circuit.

3. If the recommended B & K-PRECISION Model PR-37 oscilloscope probes are used, 10:1 attenuation should be used except for waveforms of 100 millivolts peak-to-peak or less. For the lower amplitude waveforms the direct position should be used. Whenever possible, use the high impedance, low capacity 10:1 position to minimize circuit loading.

4. Set MODE switch (1) to the ALT or CHOP position for dual-trace operation. In the ALT position, the sweep alternately displays the Channel A, then Channel B signal for observing high-frequency or high-speed waveforms. In the CHOP position, the sweep is chopped at an approximate 200 kHz rate and switched between the Channel A and Channel B trace for viewing low-frequency or low-speed waveforms. The ALT position is normally used with sweep speeds of .5 mS/cm to .5 μ S/cm and the CHOP position is normally used with sweep speeds of .5 SEC/cm to 1 mS/cm, but you may select ALT or CHOP operation at any sweep speed for special applications.
5. Adjust CH A and CH B POSITION controls (18 and 27) to place the Channel A trace above the Channel B trace, and adjust both traces to a convenient reference mark on the scale.
6. Set both the CH A and CH B AC-GND-DC switch (20 and 25) to the AC position. This is the position used for most measurements and must be used if the points being measured include a large DC component.
7. Connect the ground clips of the probes to the chassis ground of the equipment under test. Connect the tips of the probes to points in the circuit where the waveforms are to be measured.
8. Set the VOLTS/CM switches (21 and 23) and VARIABLE controls (22 and 24) for Channels A and B to a position that gives 2 to 3 divisions of vertical deflection. The displays on the screen will probably be unsynchronized. Refer to TRIGGERING procedures below for adjusting synchronization and sweep speed to obtain a stable display showing the desired number of waveforms.

TRIGGERING

The following steps are concerned with setting controls to obtain a stable, synchronized display. The proper control settings depend upon the type of waveform being observed and other factors. An explanation of the various control settings which affect synchronization of the display is given to help you select the proper settings over a wide range of conditions.

1. SOURCE Switch (17).
Triggered operation is normally used with this oscilloscope. In triggered operation, the sweep remains at rest until triggered by a sync pulse. The SOURCE switch selects the input signal that is to be used to trigger the sweep. This switch offers full versatility in selecting the trigger source.
 - a. INTERNAL position. This is the most commonly used position and provides internal sync, wherein the signal being observed on the CRT screen is also the sweep trigger as follows: When MODE switch (1) is in the CH A position, the Channel A input signal becomes the trigger and when MODE switch is in the CH B position, the Channel B input signal becomes the trigger. In the ALT, CHOP and ADD modes, the Channel A input signal again becomes the sweep trigger. Any signal that produces at least 1 cm vertical deflection develops sufficient trigger signal to synchronize the sweep if other controls are properly set. Therefore, there must be an input signal to Channel A for operation in the ALT, CHOP and ADD modes when using internal sync.

- b. CH A position. In this position, the input signal at the Channel A INPUT jack (26) becomes the trigger regardless of the position of MODE switch (1). This permits single-trace display of the Channel B signal to be synchronized to the Channel A signal if desired, and duplicates the function of the INTERNAL position in the CH A, ALT, CHOP, and ADD modes. Maximum trigger sensitivity at the Channel A INPUT jack is 5 millivolts peak-to-peak.
- c. CH B position. In this position, the input signal at the Channel B INPUT jack (19) becomes the trigger regardless of the position of MODE switch (1). This permits single-trace display in CH A and ADD modes, or dual-trace display in ALT or CHOP modes to be synchronized to the Channel B input signal if desired, in addition to duplicating the function of the INTERNAL position in the CH B mode. Maximum trigger sensitivity at the Channel B INPUT jack is 5 millivolts.
- d. LINE Position. In this position, the AC line voltage powering the oscilloscope (60 Hz in USA) is used as sync triggering. This is useful for observing waveforms that are related to the power line frequency such as power supply ripple, or a common reference for phase shift measurements at various points in line frequency related circuits.
- e. EXTERNAL position. In this position, the input signal at the EXTERNAL TRIGGER jack (15) becomes the trigger. This signal must have a time or frequency relationship to the signal being observed to synchronize the display. Maximum sensitivity is 1 volt or less peak-to-peak and maximum voltage is 50 volts (DC + AC peak). External sync is preferred for waveform observation in many applications. For example, in digital circuits where several time-related waveforms are present, as reference phase when observing phase shift at several points in non-LINE frequency related circuits, and in signal tracing to eliminate triggering readjustment at each point of measurement.

2. SYNC Switch (16).

Set the SYNC switch to the VIDEO positions for viewing television composite video signals. If the video sync pulses at the point being used as the triggering source are of positive polarity, use the VIDEO + position; if of negative polarity, use the VIDEO - position. Vertical sync pulses (FRAME) are automatically selected at sweep speeds of .1 mS/cm and slower, since these sweep speeds are appropriate for viewing vertical frames of video. Horizontal sync pulses (LINE) are automatically selected at sweep speeds of 50 μ S/cm and faster, since these sweep speeds are appropriate for viewing horizontal lines of video.

Set the SYNC switch to the SLOPE positions for viewing all other type waveforms. Use the SLOPE + position to trigger the sweep from the positive-going slope of the trigger source signal, or the SLOPE - position to trigger the sweep from the negative-going slope of the trigger source signal.

3. TRIGGERING LEVEL Control (14).

This control is pushed in for normal triggered sweep operation. When the control is pulled outward (PULL AUTO position), automatic sweep operation is selected. In automatic sweep operation, the sweep generator free-runs to generate a sweep without a trigger signal (this is also called recurrent sweep operation), but automatically switches to triggered sweep operation if an acceptable trigger source signal is present. The PULL AUTO position is handy when first setting up the scope to observe a waveform; it provides sweep for waveform observation until other controls can be properly set. Automatic sweep operation must be used for DC measurements and signals of such low amplitude that they will not trigger the sweep. Typically, signals that produce even $\frac{1}{2}$ cm of vertical deflection are adequate for normal triggered sweep operation.

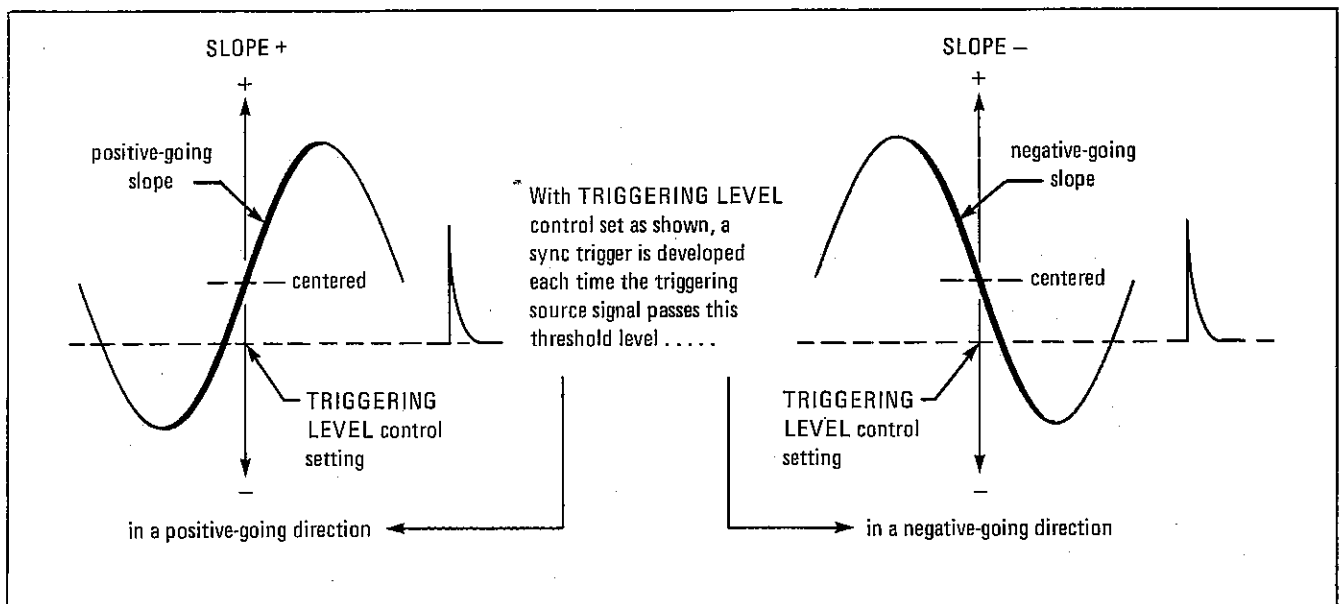

Fig. 4. Triggering slope and level.

Rotation of this control varies the triggering threshold level as illustrated in Fig. 4. In the + direction (clockwise), the triggering threshold shifts to a more positive value, and in the - direction (counterclockwise), the triggering threshold shifts to a more negative value. When the control is centered, the threshold level is set at the approximate average of the signal used as the triggering source. Note that if the TRIGGERING LEVEL control is rotated toward its extreme + or - setting, the threshold level may exceed the peak voltage of the triggering source signal and no sweep will be developed. The + and - rotation of the TRIGGERING LEVEL control adjusts the triggering threshold in both normal and automatic sweep operation. Fig. 4 illustrates SLOPE + and SLOPE - triggering from a sine wave. However, any wave shape will produce a trigger when it passes through the trigger threshold setting. Rotation of the TRIGGERING LEVEL control adjusts the phase at which sweep triggering begins on sine wave signals. For any type triggering signal, it can be used to set an amplitude threshold to prevent triggering by noise or undesired portions of the waveform.

4. Set the SOURCE switch (17) and SYNC switch (16) for the desired triggering source as explained in steps 1 and 2. If unsure, use INT source and SLOPE + sync.
5. Adjust TRIGGERING LEVEL control (14) to obtain a synchronized display without jitter. As a starting point, the control may be pushed in and rotated to any point that will produce a sweep, which is usually somewhere in the center portion of its range. The trace will disappear if there is inadequate signal to trigger the sweep, such as when measuring DC or extremely low amplitude waveforms. If no sweep can be obtained, pull the control out (PULL AUTO) for automatic triggering.
6. Set SWEEP TIME/CM switch (8) and VARIABLE control (9) for the desired number of waveforms. These controls may be set for viewing only a portion of a waveform, but the trace becomes progressively dimmer as a smaller portion is displayed. This is because the sweep speed increases but the sweep repetition rate does not change.
7. After obtaining the desired number of waveforms, as in step 6, it is often desirable to make a final adjustment of the TRIGGERING LEVEL control (14). The control may be adjusted to start the sweep on any desired portion of the waveform.
8. For a close-up view of a portion of the waveform, pull outward on the POSITION control (11). This expands the sweep by a factor of ten (10X magnification) and displays only the center portion of the sweep. To view a portion to the left of center, turn the POSITION control counterclockwise, and to view a portion to the right of center, turn the control clockwise. Push inward on the control to return the sweep to the normal, non-magnified condition.

CALIBRATED VOLTAGE MEASUREMENT (See Fig. 5)

Peak voltages, peak-to-peak voltages, DC voltages and voltages of a specific portion of a complex waveform are easily and accurately measured on the Model 1520 oscilloscope.

1. Adjust controls as previously instructed to display the waveform to be measured.
2. Be sure the CH B vertical VARIABLE control (22) is set fully clockwise to the CAL position.
3. Set CH B VOLTS/CM switch (21) for the maximum vertical deflection possible without exceeding the limits of the vertical scale.
4. Read the amount of vertical deflection (in cm) from the scale. The CH B POSITION control (18) may be readjusted to shift the reference point for easier scale reading if desired. When measuring a DC voltage, adjust the CH B POSITION control (18) to a convenient reference with the CH B AC-GND-DC switch (20) in the GND position, then note the amount the trace is deflected when the switch is placed in the DC position. The trace deflects upward for a positive voltage input and downward for a negative voltage input.
5. Calculate the voltage reading as follows: Multiply the vertical deflection (in cm) by the VOLTS/CM control (21) setting (see example Fig. 5). Remember that the voltage reading displayed on the oscilloscope is only 1/10th the actual voltage being measured when the probe is set for 10:1 attenuation. The actual voltage is displayed when the probe is set for direct measurement.
6. Calibration accuracy of this oscilloscope may be occasionally checked by observing the 0.1-volt peak-to-peak square wave signal available at the CAL 0.1 V p-p terminal (10). This calibration source should

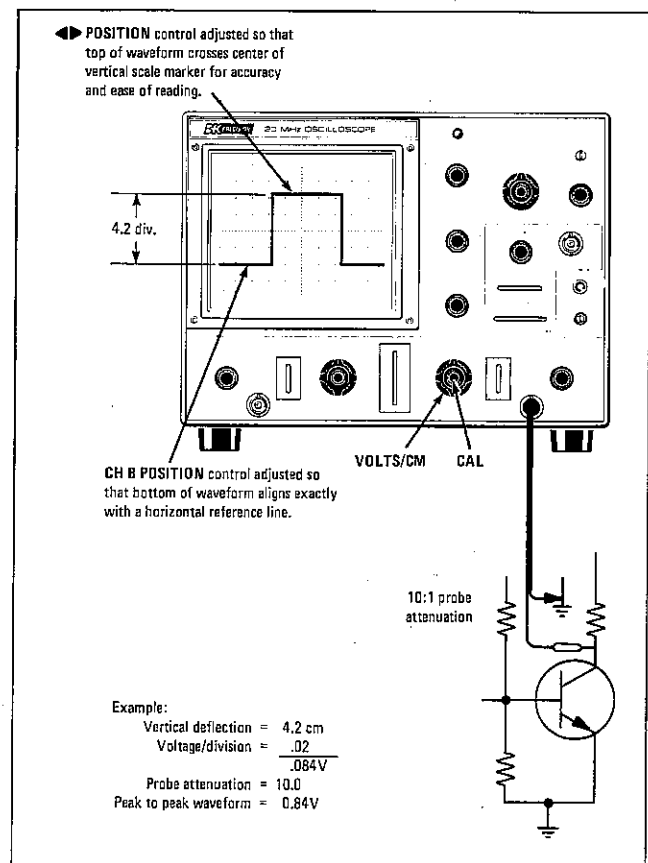

Fig. 5. Typical voltage measurement.

read exactly 0.1 volt peak-to-peak. If a need for recalibration is indicated, see the MAINTENANCE AND CALIBRATION section of the manual for complete procedures.

DIFFERENTIAL VOLTAGE MEASUREMENT (See Fig. 6)

This oscilloscope may be used to observe waveforms and measure voltages between two points in a circuit, neither of which is circuit ground. Such measurements as the inputs to a differential amplifier, the output of a phase splitter or push-pull amplifier, the amount of signal developed across a single section of voltage divider or attenuator, and many others, require this technique.

CAUTION

Never connect the ground clip of an oscilloscope probe to a circuit point other than chassis ground. The ground clip of each probe is an earth ground and will short any circuit point to which it is connected to earth ground. Unless that circuit point is already a ground, the equipment under test could be damaged.

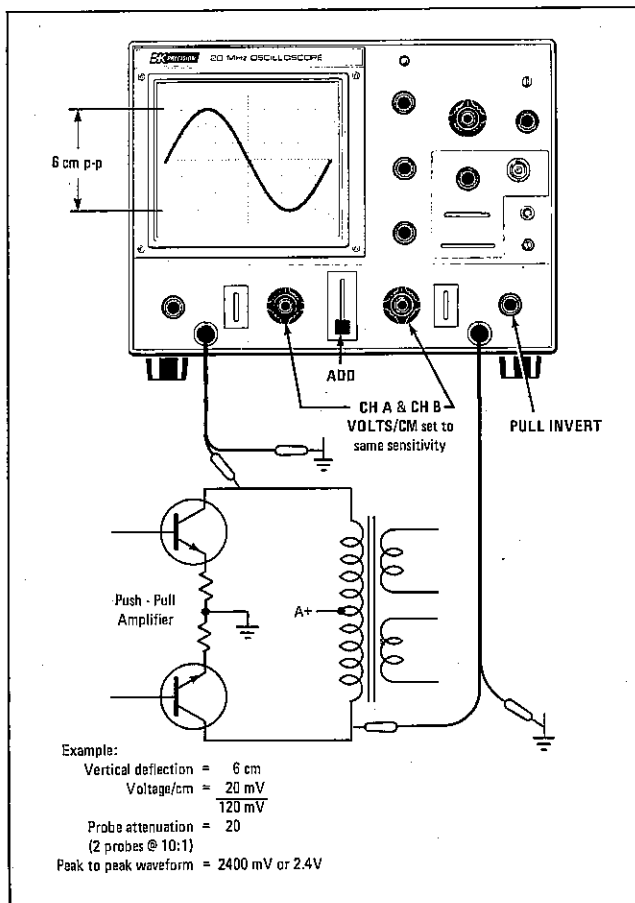

Fig. 6. Typical differential voltage measurement.

1. Adjust controls as previously described under INITIAL STARTING PROCEDURE and WAVEFORM OBSERVATION.

2. Connect a probe cable to both the CH A and CH B INPUT jacks (19 and 26). Make sure both probes are set for the same amount of attenuation, either 10:1 or direct.
3. Connect ground clips of the two probes to the chassis of equipment under test, and connect tips of the probes to the points in the circuit where measurements are to be made. It is usually desirable to connect the CH A probe to a higher potential or higher amplitude point in the circuit and the CH B probe to the lower potential or lower amplitude point in the circuit.
4. Set the MODE switch (1) to the CH A position and the SOURCE switch (17) to the INT position and adjust controls to obtain a synchronized single waveform of 2 to 6 cm vertical height with the CH A VARIABLE control (24) set to CAL.

5. If only the AC component of the waveform is of interest, use the following procedure:
 - a. Set CH A and CH B AC-GND-DC switches (20 and 25) both to the AC position.
 - b. Set CH B VARIABLE control (22) to CAL and the CH B VOLTS/CM switch (21) to the same position as the CH A VOLTS/CM switch (23).
 - c. Set the MODE switch (1) to the ADD position.
 - d. If the Channel A and Channel B signals are in phase, the displayed waveform is the sum of the amplitudes of the two signals. Any imbalance or difference can be checked by pulling outward on the CH B PULL INVERT control (18). The displayed waveform becomes the difference between the two signals.
 - e. If the Channel A and Channel B signals are 180° out of phase, such as the output of a push-pull amplifier, invert the Channel B signal by pulling outward on the CH B PULL INVERT control (18). The displayed waveform becomes the sum of the two signals. Return the Channel B signal to normal polarity by pushing in the CH B PULL INVERT control (18) to display any imbalance or difference between the two signals.
 - f. Readjust the VOLTS/CM switches (21 and 23) as required to obtain as large a waveform as possible without exceeding the limits of the vertical scale, but always keep the CH A and CH B switches set to the same sensitivity.
 - g. Position the waveform as desired with the positioning controls and calculate the peak-to-peak voltage as described in CALIBRATED VOLTAGE MEASUREMENT procedure. Since two probes are used, each with 10:1 attenuation, a multiplier of 20 must be used to obtain the actual voltage value.

6. If a DC voltage, or the DC component of the waveform is of interest, use the following procedure:
 - a. Set CH A AC-GND-DC switch (25) to the DC position.
 - b. Position the CH A VOLTS/CM switch (23) to keep the trace within the limits of the vertical scale. Use the CH A POSITION control (27) to align the

trace with one of the lines on the scale for reference.

- c. Position CH B VOLTS/CM switch (21) to the same position as the CH A VOLTS/CM switch. Set CH A and CH B VARIABLE controls (22 and 24) to CAL.
- d. Set MODE switch (1) to the CH B position and the CH B AC-GND-DC switch (20) to the GND position, and adjust out any DC offset that may be introduced by the CH B POSITION control as follows: Alternately reverse the polarity of Channel B by pulling and pushing the CH B PULL INVERT control (18), adjusting the CH B POSITION control (18) until the trace position does not shift when the polarity is reversed.
- e. Return CH B AC-GND-DC switch (20) to the DC position.
- f. Momentarily return the MODE switch (1) to the CH A position and note the trace position for reference. You may readjust it with the Channel A vertical positioning control, but not the Channel B control. Place the MODE switch in the ADD position and pull the CH B PULL INVERT switch (18). The amount of displacement of the trace from the Channel A reference represents the voltage differential between the two points of measurement.

CALIBRATED TIME MEASUREMENT (See Fig. 7)

Pulse width, waveform periods, circuit delays and all other waveform time durations are easily and accurately measured on this oscilloscope. Calibrated time measurements from .5 second down to .05 microsecond are possible. At low sweep speeds, the entire waveform is not visible at one time. However, the bright spot can be seen moving from left to right across the screen, which makes the beginning and ending points of the measurement easy to spot.

1. Adjust controls as previously described for a stable display of the desired waveform.
2. Be sure the sweep time VARIABLE control (9) is fully clockwise to the CAL position.
3. Set the SWEEP TIME/CM control (8) for the largest possible display of the waveform segment to be measured, usually one cycle.
4. If necessary, readjust the TRIGGERING LEVEL control (14) for the most stable display.
5. Read the amount of horizontal deflection (in cm) between the points of measurement. The ◀ POSITION control (7) may be readjusted to align one of the measurement points with a vertical scale marker for easier reading.
6. Calculate the time duration as follows: Multiply the horizontal deflection (in cm) by the SWEEP TIME/CM switch (8) setting (see example in Fig. 7). Remember, when the 10X magnification is used, the result must be divided by 10 to obtain the actual time duration.
7. Time measurements often require external sync. This is especially true when measuring delays. The sweep is

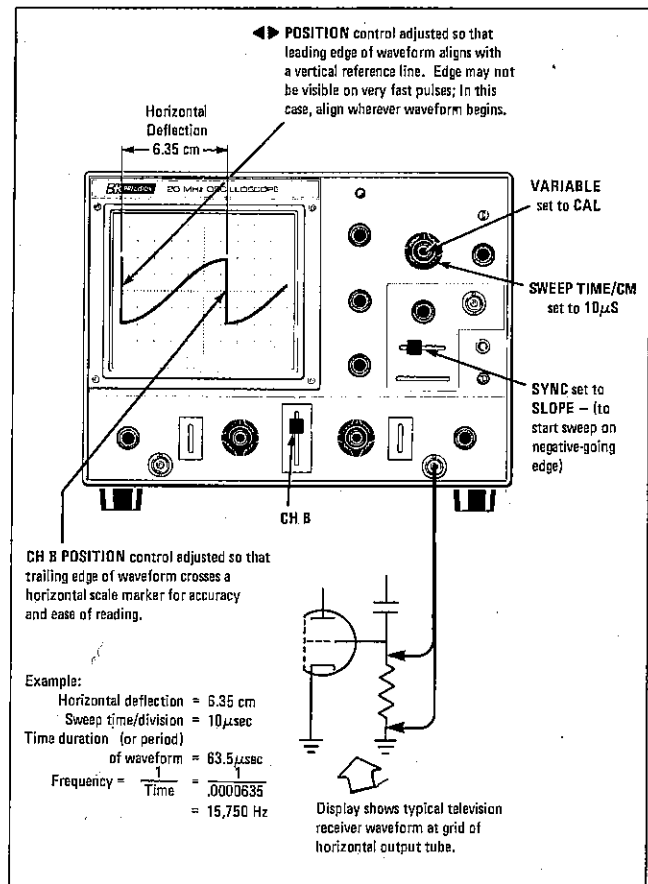

Fig. 7. Typical time measurement.

started by a sync from one circuit and the waveform measured in a subsequent circuit. This allows measurement of the display between the sync pulse and the subsequent waveform. To perform such measurements using external sync, use the following steps:

- a. Set the SOURCE switch (17) to the EXT position.
 - b. Connect a cable from the EXT TRIG jack (15) to the source of sync signal. Use a short shielded cable.
 - c. Set the SYNC switch (16) to the SLOPE (+) or (-) position for the proper polarity for the sync signal.
 - d. Readjust the TRIGGERING LEVEL control (14) if necessary for a stable waveform.
 - e. If measuring a delay, measure the time from the start of the sweep to the start of the waveform.
8. Another excellent method for measuring time delays is with dual-trace operation. Display the input signal on Channel A and the output signal on Channel B. Use CH A sync and calculate the time delay by measuring the horizontal displacement between the same point on the Channel A and Channel B waveforms.

EXTERNAL HORIZONTAL INPUT (X-Y OPERATION)

For some measurements, an external horizontal deflection signal is required. This is also referred to as an X-Y measurement, where the Y input provides vertical deflection and the X input provides horizontal deflection. The

horizontal input may be a sinusoidal wave, such as for phase measurement, or an external sweep voltage, such as for frequency response measurements and sweep generator alignment of RF bandpass circuits. A typical example is illustrated in Fig. 8. With mV/cm sensitivity, any X-axis input of 50 mV or greater is sufficient for satisfactory operation. To use an external horizontal input, use the following procedure:

1. Set the SWEEP TIME/CM switch (8) fully clockwise to the CH B position.
2. Use the Channel A probe for the vertical input and the Channel B probe for the horizontal input.
3. Adjust the amount of horizontal deflection with the CH B VOLTS/CM and VARIABLE controls (21 and 22).
4. The CH B (vertical) POSITION control now serves as the horizontal position control, and the ◀ POSITION control is disabled.

NOTE

Do not use the PULL 10X MAG control during X-Y operation. Use the CH B VARIABLE and VOLTS/CM controls to adjust horizontal gain.

5. All sync controls are disconnected and have no effect.

Z-AXIS INPUT

The trace displayed on the screen may be intensity-modulated (Z-axis input) where frequency or time-scale marks are required. A 5-volt peak-to-peak or greater signal applied to the Z-AXIS INPUT jack (29) on the rear of the oscilloscope will provide alternate brightness and blanking of the trace. Positive voltage input increases brightness. See Fig. 9.

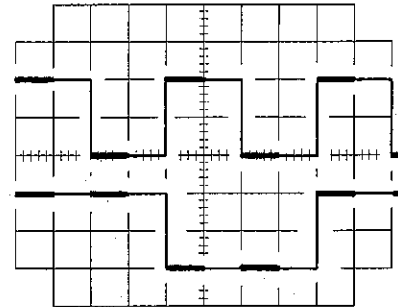

Fig. 9. Oscilloscope display with Z-axis input.

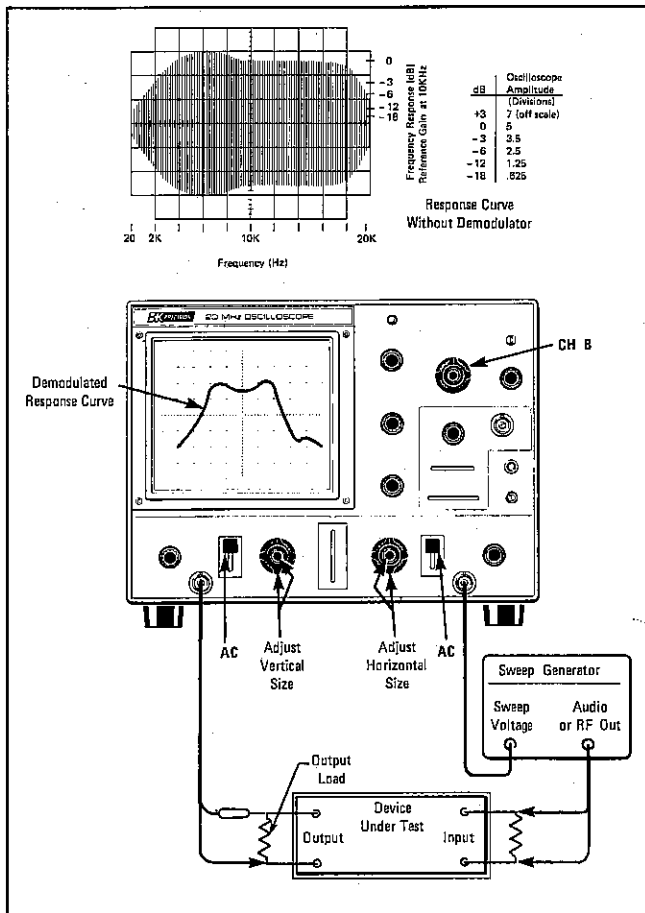

Fig. 8. Typical X-Y operation.

DUAL-TRACE APPLICATIONS

INTRODUCTION

The most obvious and yet the most useful feature of the dual-trace oscilloscope is that it has the capability for viewing simultaneously two waveforms that are frequency- or phase-related, or that have a common synchronizing voltage such as in digital circuitry. Simultaneous viewing of "cause and effect" waveforms is an invaluable aid to the circuit designer or the repairman. Several possible applications of the dual-trace oscilloscope will be reviewed in detail to familiarize the user further in the basic operation of this oscilloscope.

FREQUENCY DIVIDER WAVEFORMS

Fig. 3 illustrates the waveforms involved in a basic divide-by-two circuit. Fig. A indicates the reference or "clock" pulse train. Fig. B and Fig. C indicate the possible outputs of the divide-by-two circuitry. Fig. 3 also indicates the settings of specific oscilloscope controls for viewing these waveforms. In addition to these basic control settings, the TRIGGERING LEVEL control, as well as the Channel A and Channel B vertical position controls should be set as required to produce suitable displays. In the drawing of Fig. 8, the waveform levels of 2 divisions are indicated. If the exact voltage amplitudes of the Channel A and Channel B waveforms are desired, the Channel A and Channel B VARIABLE controls must be placed in the CAL position. The Channel B waveform may be either that indicated in Fig. 3B or 3C. In Fig. 3C the divide-by-two output waveform is shown for the case where the output circuitry responds to a negative-going waveform. In this case, the output waveform is shifted with respect to the leading edge of the reference frequency pulse by a time interval corresponding to the pulse width.

DIVIDE-BY-8 CIRCUIT WAVEFORMS

Fig. 10 indicates waveform relationships for a basic divide-by-eight circuit. The basic oscilloscope settings are identical to those used in Fig. 3. The reference frequency of Fig. 10A is supplied to the Channel B input. Fig. B indicates the ideal time relationships between the input pulses and the output pulse.

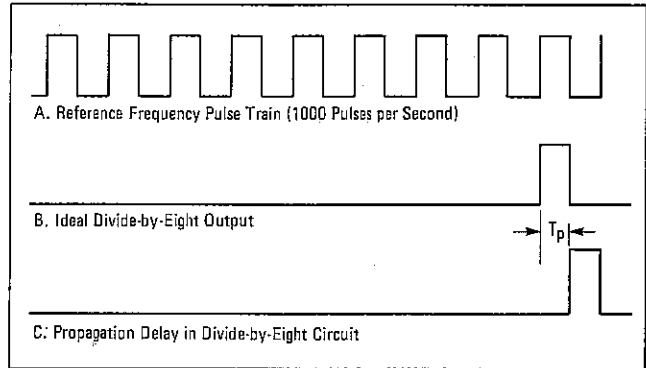

Fig. 10. Waveforms in divide-by-eight circuit.

In an application where the logic circuitry is operating at or near its maximum design frequency, the accumulated rise time effects of the consecutive stages produce a built-in time propagation delay which can be significant in a critical circuit and must be compensated for. Fig. 10C indicates the possible time delay which may be introduced into a frequency divider circuit. By use of the dual trace oscilloscope the input and output waveforms can be superimposed to determine the exact amount of propagation delay that occurs.

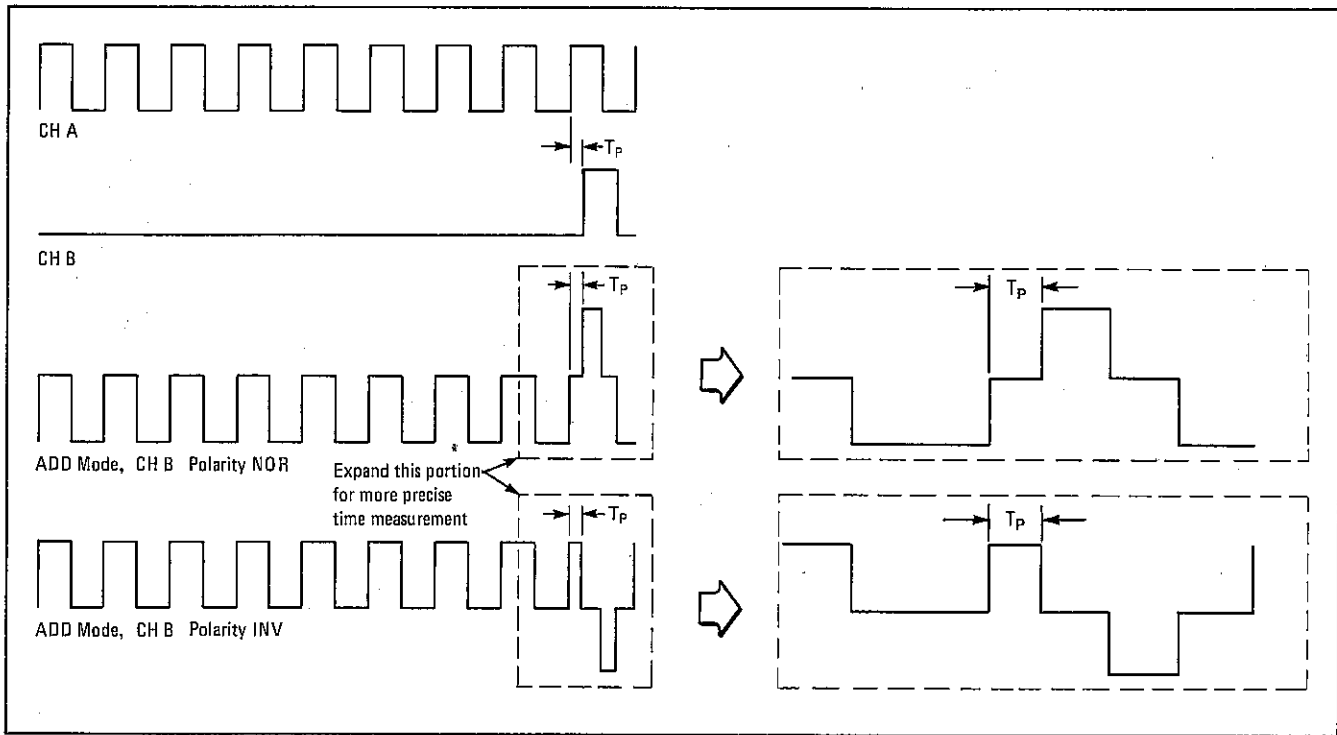

Fig. 11. Using ADD mode for propagation time measurement.

PROPAGATION TIME MEASUREMENT

An example of propagation delay in a divide-by-eight circuit was given in the previous paragraph. Significant propagation delay may occur in any circuit with several consecutive stages. This oscilloscope has features which simplify measurement of propagation delay. Fig. 11 shows the resultant waveforms when the dual-trace presentation is combined into a single-trace presentation by selecting the ADD position of the MODE switch. With CH B PULL INVERT switch in the normal position (pushed in) the two inputs are algebraically added in a single trace display. Similarly, in the inverted position (pull) the two inputs are algebraically subtracted. Either position provides a precise display of the propagation time (T_p). Using the procedures given for calibrated time measurement, T_p can be measured. A more precise measurement can be obtained if the T_p portion of the waveform is expanded horizontally. This may be done by pulling the PULL 10X MAG control. It also may be possible to view the desired portion of the waveform at a faster sweep speed.

DIGITAL CIRCUIT TIME RELATIONSHIPS

A dual-trace oscilloscope is a necessity in designing, manufacturing and servicing digital equipment. It permits easy comparison of time relationships between two waveforms.

In digital equipment, it is common for a large number of circuits to be synchronized, or to have a specific time relationship to each other. Many of the circuits are frequency dividers as previously described, but waveforms

are often time-related in many other combinations. In the dynamic state, some of the waveforms change, depending upon the input or mode of operation. Fig. 12 shows a typical digital circuit and identifies several of the points at which waveform measurements are appropriate. The accompanying Fig. 13 shows the normal waveforms to be expected at each of these points and their timing relationships. The individual waveforms have limited value unless their timing relationship to one or more of the other waveforms is known to be correct. The dual-trace oscilloscope allows this comparison to be made. In typical fashion, waveform No. 3 would be displayed on Channel A and waveforms No. 4 through No. 10 would be successively displayed on Channel B, although other timing comparisons may be desired.

In the family of time-related waveforms shown in Fig. 13, waveform No. 8 or No. 10 is an excellent sync source for viewing all of the waveforms; there is but one triggering pulse per frame. For convenience, external sync using waveform No. 8 or No. 10 as the sync source may be desirable. With external sync, any of the waveforms may be displayed without readjustment of the sync controls. Waveforms No. 4 through No. 7 should not be used as the sync source because they do not contain a triggering pulse at the start of the frame. It would not be necessary to view the entire waveforms as shown in Fig. 13 in all cases. In fact, there are many times when a closer examination of a portion of the waveforms would be appropriate. In such cases, it is recommended that the sync-remain unchanged while the sweep speed or 10X magnification is used to expand the waveform display.

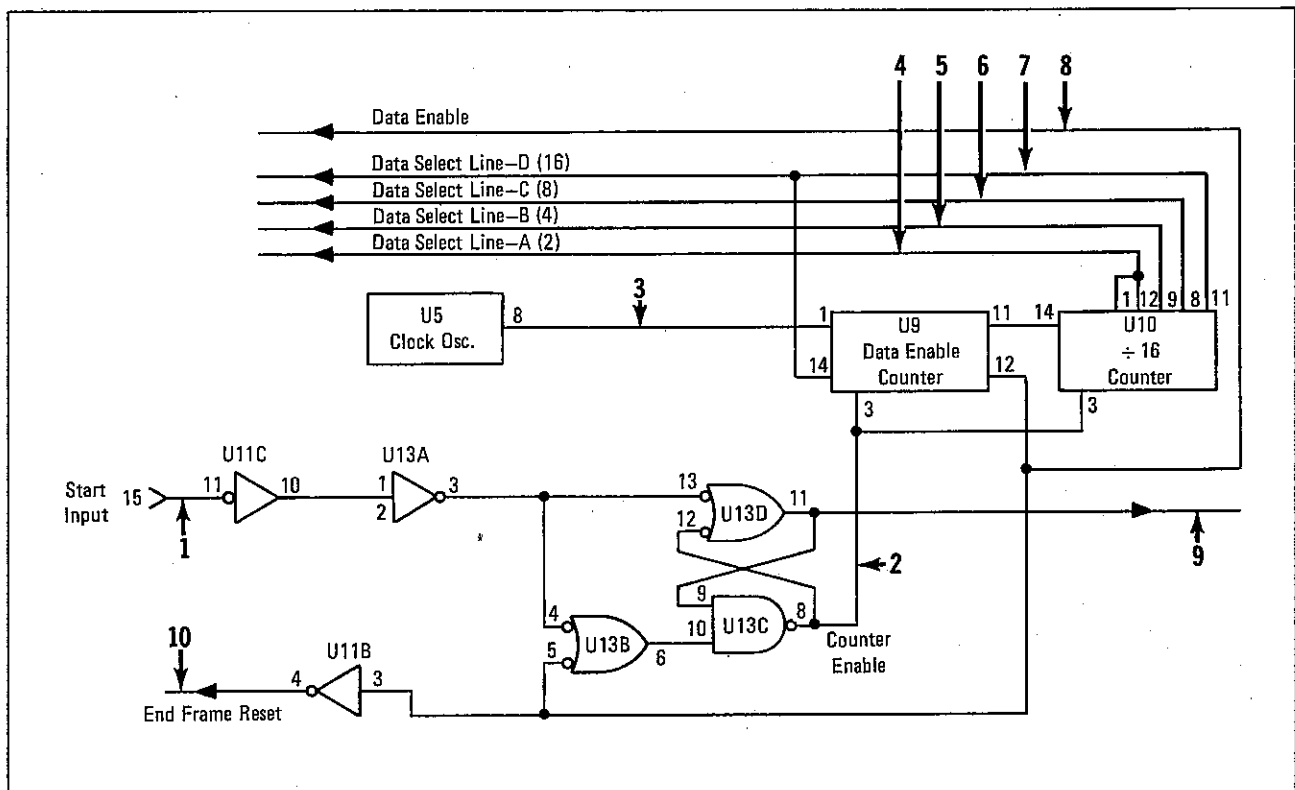

Fig. 12. Typical digital circuit using several time-related waveforms.

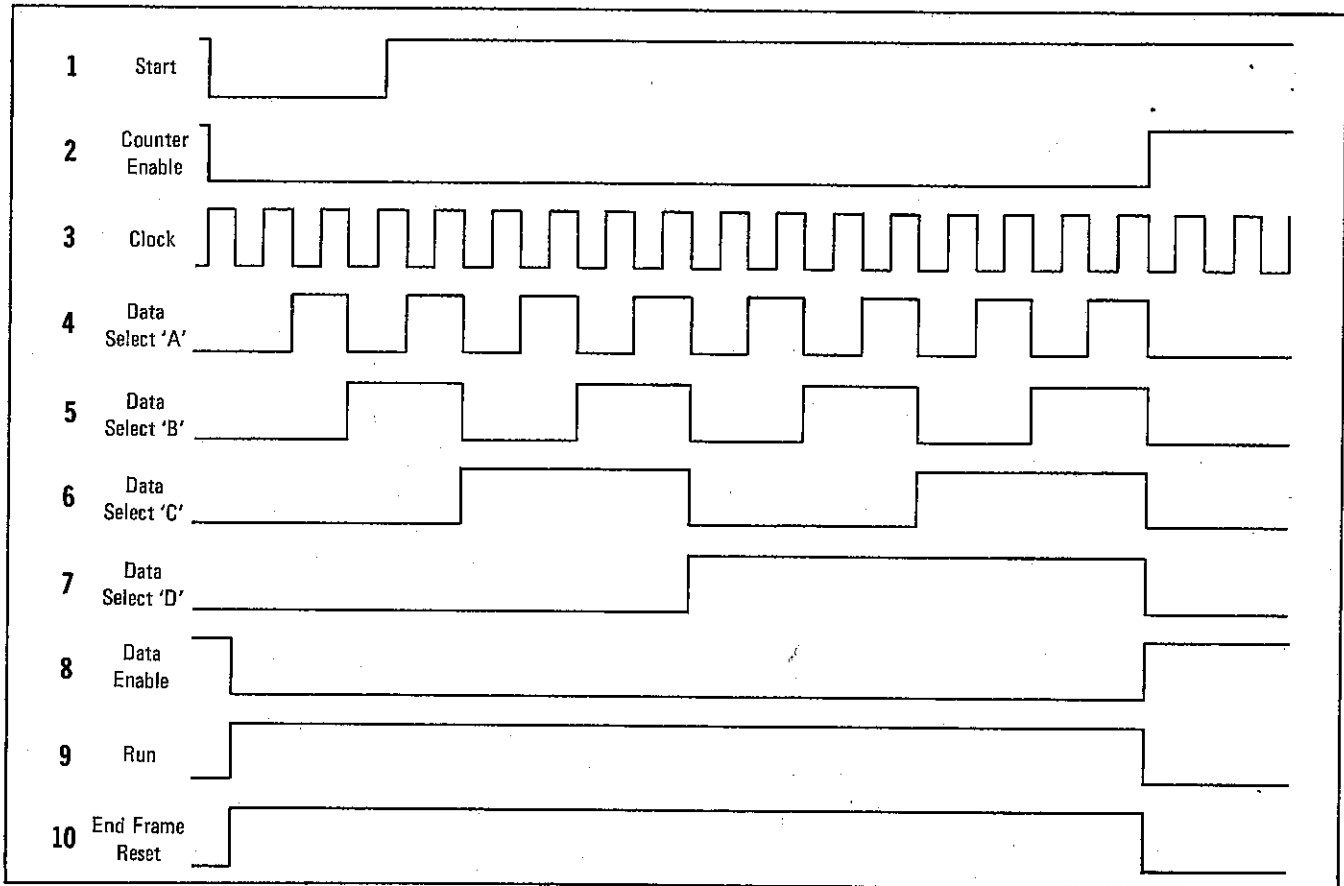

Fig. 13. Family of time-related waveforms from digital circuit in Fig. 12.

DISTORTION MEASUREMENT

An amplifier stage, or an entire amplifier unit, may be tested for distortion with this oscilloscope. This type of measurement is especially valuable when the slope of a waveform must be faithfully reproduced by an amplifier. Fig. 14 shows the testing of such a circuit using a triangular wave, such as is typically encountered in the recovered audio output of a limiting circuit which precedes the modulator of a transmitter. The measurement may be made using any type of signal; merely use the type of signal for testing that is normally applied to the amplifier during normal operation. The procedure for distortion testing follows:

1. Apply the type of signal normally encountered in the amplifier under test.
2. Connect Channel A probe to the input of the amplifier and Channel B probe to the output of the amplifier. It is preferable if the two signals are not inverted in relationship to each other, but inverted signals can be used.
3. Set CH A and CH B AC-GND-DC switches to AC.
4. Set MODE switch to ALT or CHOP, depending upon the sweep speed.
5. Set sync SOURCE switch to INT and adjust controls as described in waveform viewing procedure for synchronized waveforms.

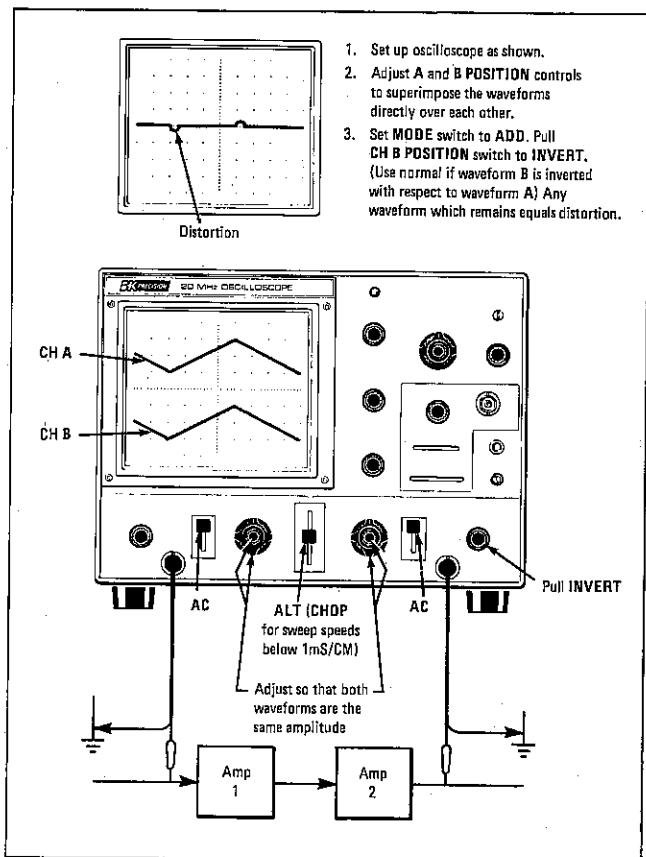

Fig. 14. Distortion measurement.

6. Adjust the CH A and CH B POSITION controls to superimpose the waveforms directly over each other.
7. Adjust the CH A and CH B vertical sensitivity controls (VOLTS/CM and VARIABLE) so that the waveforms are as large as possible without exceeding the limits of the scale, and so that both waveforms are exactly the same height.
8. Now set the MODE switch to the ADD position and pull CH B PULL INVERT switch (if one waveform is inverted in relationship to the other, use normal Channel B polarity). Adjust the fine vertical sensitivity (CH B VARIABLE) slightly for the minimum remaining waveform. Any waveform that remains equals distortion; if the two waveforms are exactly the same amplitude and there is no distortion, the waveforms will cancel and there will be only a straight horizontal line remaining on the screen.

Methods for dynamic testing of amplifiers using square and sine waves are given later in this Instruction Manual.

DELAY LINE TESTS

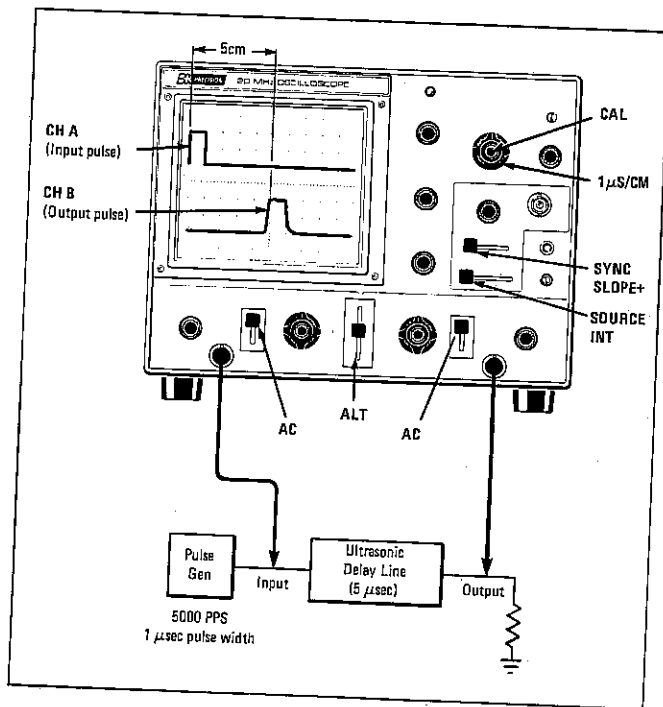

Fig. 15. Delay line measurement.

The dual-trace feature of the oscilloscope also can be used to determine the delay times of transmission-type delay lines as well as ultrasonic-type delay lines. The input pulse can be used to trigger or synchronize the Channel A display and the delay line output can be observed on Channel B. A repetitive type pulse will make it possible to synchronize the displays. The interval between repetitive pulses should be large compared to the delay time to be investigated. In addition to determining delay time, the pulse distortion inherent in the delay line can be determined by examination of the delayed pulse observed on the Channel B waveform display. Fig. 15 demonstrates the typical oscilloscope settings as well as the basic test circuit.

Typical input and output waveforms are shown on the oscilloscope display. Any pulse stretching and ripple can be observed and evaluated. The results of modifying the input and output terminations can be observed directly.

A common application of the delay line checks is found in color television receivers to check the "Y" delay line employed in the video amplifier section. The input waveform and the output waveform are compared for delay time, using the horizontal sync pulse of the composite video signal for reference. The delay is approximately one microsecond. In addition to determining the delay characteristics of the line, the output waveform reveals any distortion that may be introduced from an impedance mismatch or a greatly attenuated output resulting from an open line.

IMPROVING THE RATIO OF DESIRED-TO-UNDESIRED SIGNALS

In some applications, the desired signal may be riding on a large undesired signal component such as 60 Hz. It is possible to minimize or for practical purposes eliminate the undesired component. Fig. 16 indicates the oscilloscope control settings for such an application. The waveform display of Channel A indicates the desired signal and the dotted line indicates the average amplitude variation corresponding to an undesired 60 Hz component. The Channel B display indicates a waveform of equal amplitude and identical phase to the average of the Channel A waveform. With the MODE switch set to ADD and the Channel B signal inverted, and by adjusting the CH B vertical attenuator controls, the 60 Hz component of the Channel A signal can be cancelled by the Channel B input and the desired waveform can be observed without the 60 Hz component.

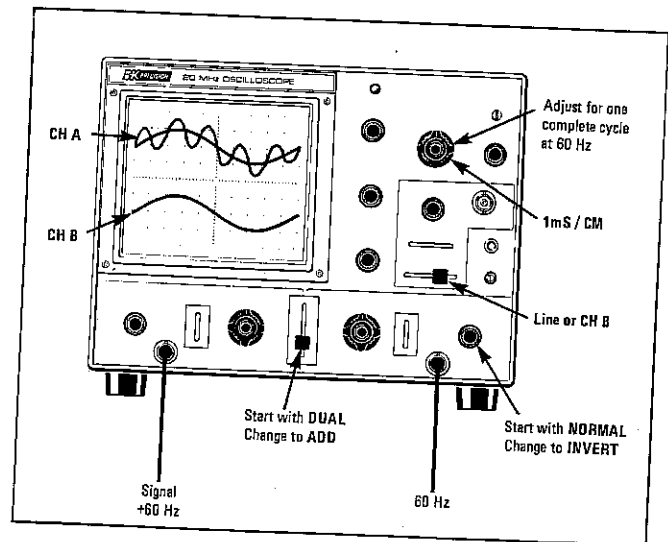

Fig. 16. Improving desired-to-undesired signal ratio.

VIDEO PRODUCT SERVICING APPLICATIONS

GENERAL

A triggered sweep oscilloscope is advantageous in servicing and aligning television receivers, monitors and video record/playback equipment. The Model 1520 oscilloscope includes in addition, several features that were incorporated to make video product servicing easier and more comprehensive. These features include:

- Automatic vertical or horizontal sync pulse selection. The SWEEP TIME/CM control, automatically selects vertical sync at sweep speeds appropriate for viewing frames and horizontal sync at sweep speeds appropriate for viewing lines.
- Built in sync separator circuits for stable triggering on composite video signals, separates vertical and horizontal sync pulses.
- Wide bandwidth with flat in-band response and gradual frequency roll-off for high resolution video and pulse presentation. This makes the oscilloscope especially useful for verifying and adjusting chroma, video, luminance and sync levels.

COMPOSITE VIDEO WAVEFORM ANALYSIS

Probably the most important waveform in television and video servicing is the composite waveform consisting of the video signal, the blanking pedestals and the sync pulses. Fig. 17 shows typical oscilloscope traces when observing composite video signals synchronized with horizontal sync pulses and vertical sync pulses. Composite video signals can be observed at various stages of the television receiver to determine whether circuits are performing normally. Knowledge of waveform makeup, the appearance of a normal waveform, and the causes of various abnormal waveforms help the technician locate and correct many problems. The technician should study such waveforms in a television receiver known to be in good operating condition, noting the waveform at various points in the video amplifier.

To set up the oscilloscope for viewing composite video waveforms, use the following procedure:

1. Turn the television set or video recorder receiver to a local channel. A test tape or a signal generator also can be used for service work.
2. Set the MODE switch to the CH B position.
3. Set the SWEEP TIME/CM switch to the $10\ \mu\text{S}/\text{cm}$ position for observing TV horizontal lines or to the $2\ \text{mS}/\text{cm}$ position for observing TV vertical frames.
4. Set the SYNC switch to the VIDEO+ or VIDEO- position.
5. Set the SOURCE switch to the INT position.
6. Best overall sync performance is obtained when the TRIGGERING LEVEL/PULL AUTO control is pushed in. It may be pulled out initially to provide continuous sweep during set-up.

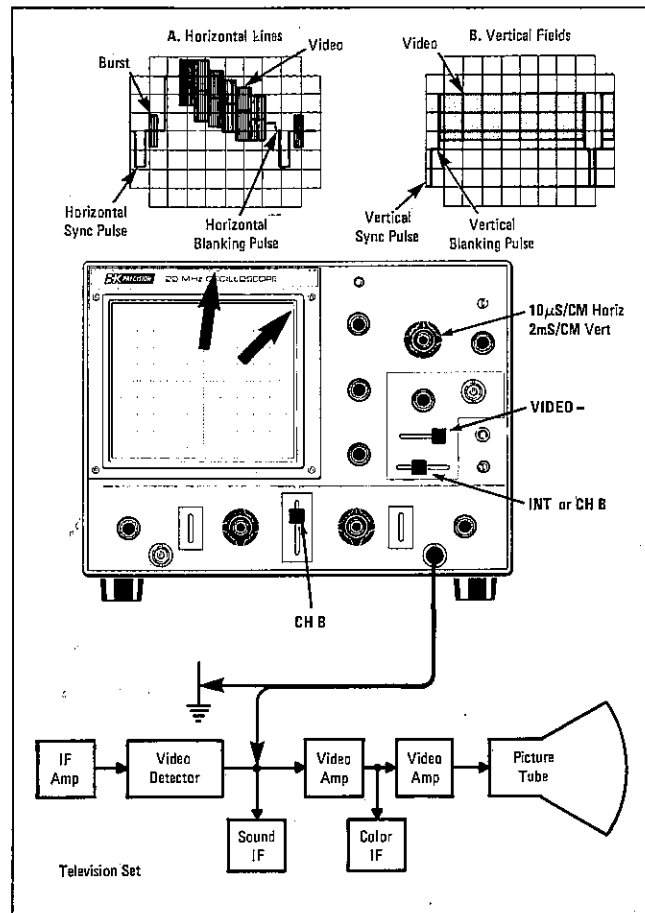

Fig. 17. Set-up for viewing horizontal lines and vertical fields of composite video signal.

7. Set the CH B AC-GND-DC switch to the AC position.
8. Connect the ground clip of the probe to the television set or video recorder chassis. With the probe set for 10:1 attenuation, connect the tip of the probe to the video detector output.
9. Set the CH B VOLTS/CM switch for the largest vertical deflection possible without going off-scale.
10. If necessary, rotate the TRIGGERING LEVEL control to a position that provides a synchronized display.
11. Adjust the sweep time VARIABLE control for two horizontal lines or two vertical frames of composite video display.
12. If the sync and blanking pulses of the displayed video signals are positive, set the SYNC switch to the VIDEO+ position; if the sync and blanking pulses are negative, use the VIDEO- position.
13. Push in the TRIGGERING LEVEL control and rotate to a position that provides a well-synchronized display.

14. Adjust the INTENSITY and FOCUS controls for the desired brightness and best focus.
15. To view a specific portion of the waveform, such as the color burst, pull outward on the ◀ POSITION control for 10X magnification. Rotate the same control left or right to select the desired portion of the waveform to be viewed.
16. Composite video waveforms may be checked at other points in the video circuits by moving the probe tip to those points and changing the VOLTS/CM control setting as required to keep the display within the limits of the scale, and by readjusting the TRIGGERING LEVEL control to maintain stabilization. The polarity of the observed waveform may be reversed when moving from one monitoring point to another; therefore, it may be necessary to switch from VIDEO+ to VIDEO- sync, or vice versa.

VITS (VERTICAL INTERVAL TEST SIGNAL) AND VIR (VERTICAL INTERVAL REFERENCE)

Most network television signals contain built-in test signals (VIR and VITS) that can be very valuable tools in troubleshooting and servicing video equipment. The VITS can localize trouble to the antenna, tuner, IF or video sections and shows when realignment may be required. The VIR signal is being used in some television receivers for automatic color correction.

The VITS and VIR signals are transmitted during the vertical blanking interval. On the television set, they can be seen as a bright white line above the top of the picture, when the vertical linearity or height is adjusted to view the vertical blanking interval. (On TV sets with internal retrace blanking circuits, the blanking circuit must be disabled to see these signals.)

The transmitted VITS and VIR are precision sequences of specific frequencies, amplitudes, and waveshapes. The television networks use the precision signals for adjustment and checking of network transmission equipment, but the technician can use them to evaluate television set performance. The make-up of the VITS varies from one broadcast station to another. Figs. 18 and 19 show typical VITS signals. The VITS normally contain a "multiburst" signal which typically begins with a "flag" of white video, followed by sine wave frequencies of 0.5 MHz, 1.5 MHz, 2 MHz, 3 MHz, 3.6 MHz, (3.58 MHz) and 4.2 MHz. The multiburst may appear on line 17 or 18, and may be repeated on line 279 or 280. As seen on the television screen, field #1 is interlaced with field #2 so that line 17 is followed by line 279 and line 18 is followed by line 280. The VITS and VIR appear at the end of the vertical blanking interval and just before the first line of video. The VIR signal is transmitted on lines 19 of fields #1 and #2 (line 19 of field #2 also is identified as frame line 281).

The multiburst portion of the VITS is the portion that can be most valuable to the technician. All frequencies of the multiburst are transmitted at the same level. By

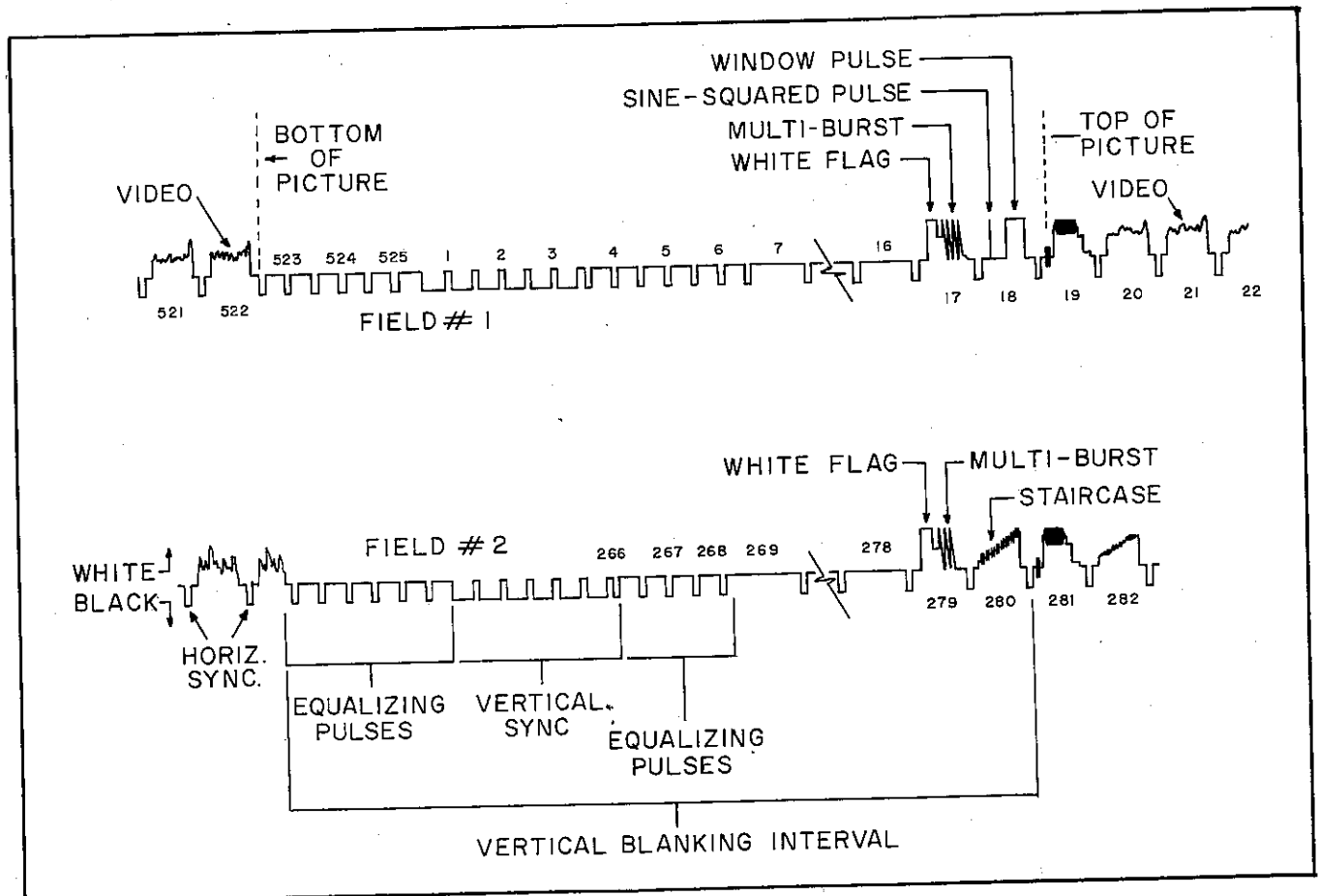

Fig. 18. Vertical blanking interval showing typical VITS and VIR information.

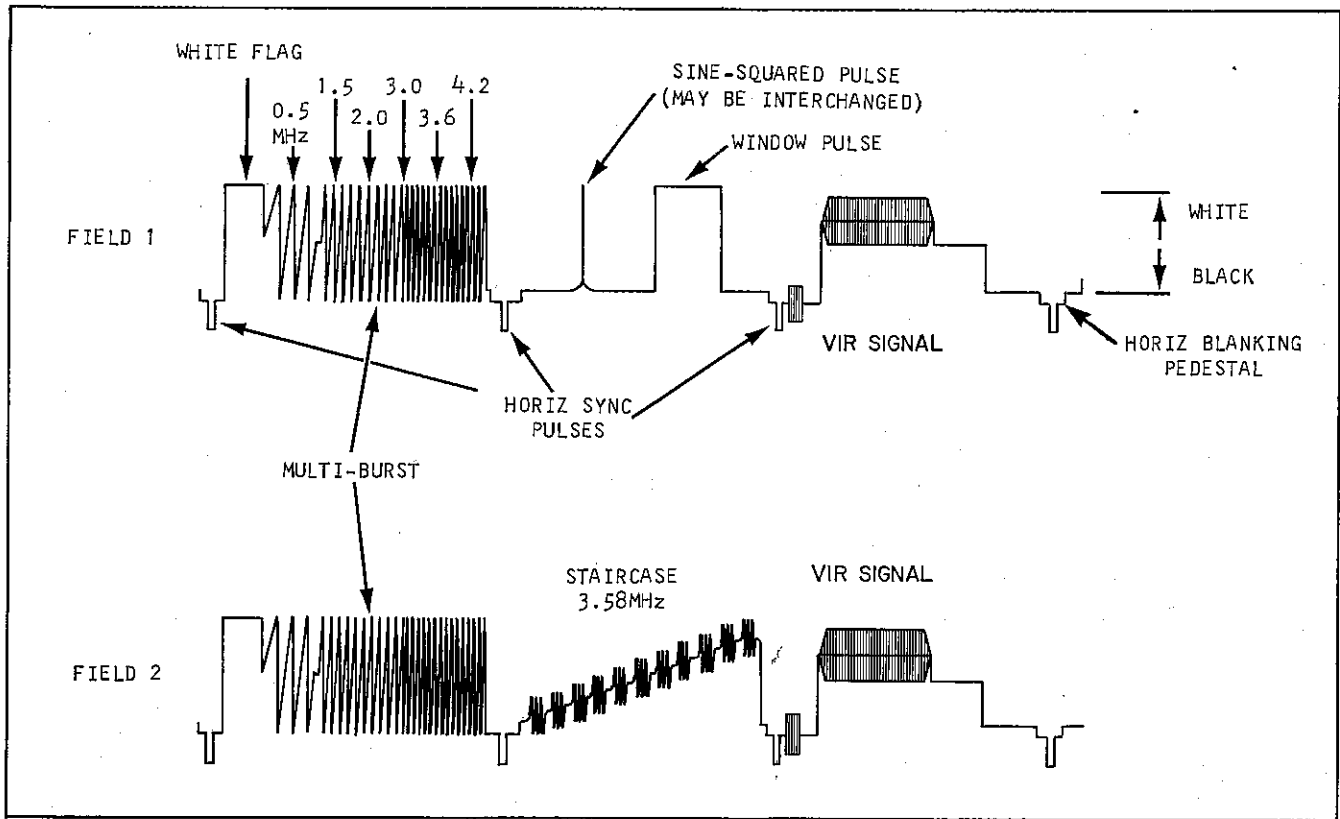

Fig. 19. Typical VITS and VIR signals, fields 1 and 2.

examining the recovered video in the video equipment, the frequency response can be evaluated and used as a servicing aid. Other portions of the VITS, including the sine-squared pulse, window pulse and the staircase of 3.5 MHz bursts at progressively lighter shading, are valuable to the networks, but have less value to the technician.

With dual-trace oscilloscope operation, the signal information on each vertical blanking interval can be viewed separately without trace overlapping, although the information alternates with each field. Fig. 20 indicates the oscilloscope control setting for viewing the alternate vertical blanking intervals.

1. The color television receiver on which the vertical interval information is to be viewed must be set to a station transmitting a color broadcast.
2. The control settings of Fig. 20 are those required to obtain a 2-field vertical display on Channel A.
3. With the oscilloscope and television receiver operating, connect the Channel A probe (set at 10:1) to the video detector test point.
4. If the sync and blanking pulses of the observed video signal are positive, set the SYNC switch to VIDEO+. If the sync and blanking pulses are negative, use the VIDEO- position.
5. Adjust the sweep time VARIABLE control so that two vertical fields are displayed on the oscilloscope screen.
6. Connect the Channel B probe (set to 10:1) to the video detector test point.

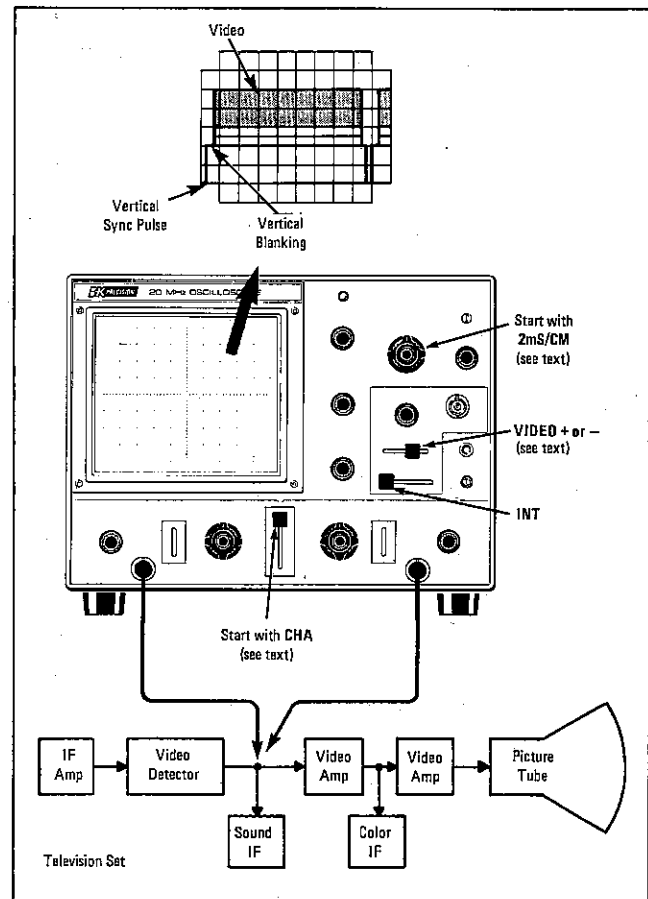

Fig. 20. Initial set-up for viewing field 1 and 2 VITS and VIR information.

7. Set the MODE switch to the ALT position. Identical waveform displays should now be obtained on Channels A and B.
8. Place the sweep time VARIABLE control in the CAL position.
9. Set the SWEEP TIME/CM control to the .1 mS/cm position. This expands the display by increasing the sweep speed. The vertical interval information will appear toward the right hand portion of the expanded waveform displays. The waveform information on each trace may appear as shown in the drawings of Fig. 18. Because there is no provision for synchronizing the oscilloscope display to either of the two fields which comprise a complete vertical frame, it cannot be predicted which field display will appear on the Channel A or Channel B display.

Pull 10X MAG control outward to obtain an additional 10X magnification. Rotate the control in a counterclockwise direction moving the traces to the left until the expanded information appears as shown in Fig. 19.

NOTE

Because of the low repetition rate and the high sweep speed combination, the brightness level of the signal displays will be reduced.

10. Once the Channel A and Channel B displays have been identified as being either field #1 or field #2 vertical interval information, the probe corresponding to the waveform display which is to be used for signal-tracing and trouble-shooting can be used, and the remaining probe should be left at the video detector test point to insure that the sync signal is not interrupted. If the sync signal is interrupted, the waveform displays may reverse because, as previously explained, there is no provision in the oscilloscope to identify either of the two vertical fields which comprise a complete frame.

TELEVISION ALIGNMENT

Alignment of tuners, the video IF strip, and chroma circuits in television receivers and VTRs requires an oscilloscope, such as Model 1520. The additional pieces of test equipment required are sweep generators for video sweep, IF sweep and RF sweep, marker generators, DC bias supplies and a VTVM. The sweep generator method of alignment displays a bandpass response curve on the screen of the oscilloscope of the type always shown in theory books and in the television manufacturer's alignment instructions (typical response curves are shown in Fig. 21).

The ideal instruments for television alignment are this oscilloscope and the B & K-PRECISION Sweep/Marker Generator. The B & K-PRECISION Sweep/Marker Generator provides all necessary sweep ranges, markers and DC bias voltages, all from one instrument. The simplified operating procedure and calibrated accuracy of the instrument results in precision alignment. For complete alignment instructions of each particular television set, follow the manufacturer's instructions.

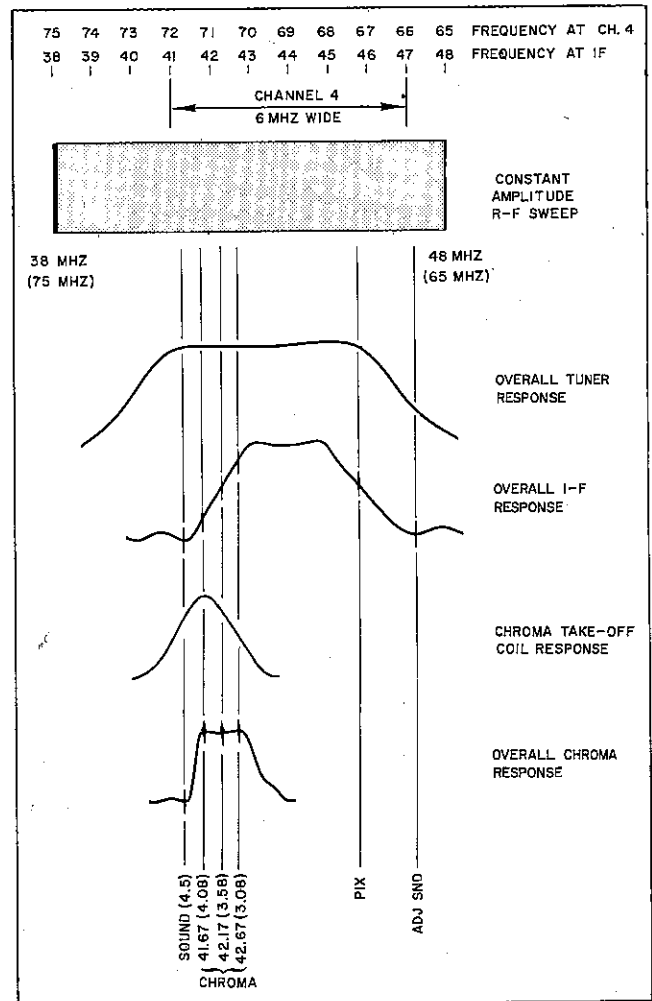

Fig. 21. TV response curves obtained by sweep frequency techniques.

NOTE

For a comprehensive analysis of television alignment, we recommend the instruction manual for the B & K-PRECISION Model 415 Sweep/Marker Generator. This "handbook of television alignment" includes not only the procedures for using the instrument, but all the how and why answers about television alignment in general. Even if you use other sweep generators, this comprehensive manual provides valuable procedures, insights and tips that will make alignment easier and more professional. The many illustrations and easy-to-understand step-by-step approach qualify it as the "how to align" textbook. Copies are available from your B & K-PRECISION distributor or the factory.

VECTORSCOPE OPERATION

Performance testing and adjustment of the color circuits in color television receivers is simplified by using the vectorscope operation of the oscilloscope. The additional equipment needed is a color bar generator. The B & K-PRECISION color bar generators are ideally suited for this.

1. Attach vector overlay to scope. Remove bezel and graticule scale. Replace graticule scale with vector overlay and replace bezel.
2. Connect the color bar generator to the television set and tune in the color bar pattern.
3. Adjust the television set's hue and brilliance controls to mid-range.
4. Set SWEEP TIME/CM control to the CH B position for X-Y operation.
5. Connect probe cables to the CH A and CH B INPUT jacks. Channel A is the vertical input and Channel B is the horizontal input. Connect both probe tips to the driven element of the red gun, usually the grid. If the cathode is the driven element, then connect to the cathode. (The driven element is the element to which the output signal of the color amplifier is applied.)

6. Adjust the CH A (vertical gain) and CH B (horizontal gain) VOLTS/CM and VARIABLE controls to equal settings and to obtain a waveform amplitude that approximately fills the vector overlay with the compressed 45° pattern.
7. For vector presentation, merely move the horizontal probe to the driven element of the blue gun. The color vector pattern is the same type as given by the television set manufacturer. Fig. 21A shows typical displays obtained for sets using 105° systems and 90° systems with either grid drive or cathode drive.

NOTE

If the picture tube uses cathode drive, the burst will appear on the right side of the screen. Just rotate the vector overlay 180° so the BURST label is on the right side. The color bars will then align with the vector overlay.

The vector display provides a very quick measurement of the functions of the demodulators in a color TV set. The serviceman should familiarize himself with the effect of the pattern produced by the color controls. He should observe that the color amplitude control will vary the size of the petals but not their position. The hue

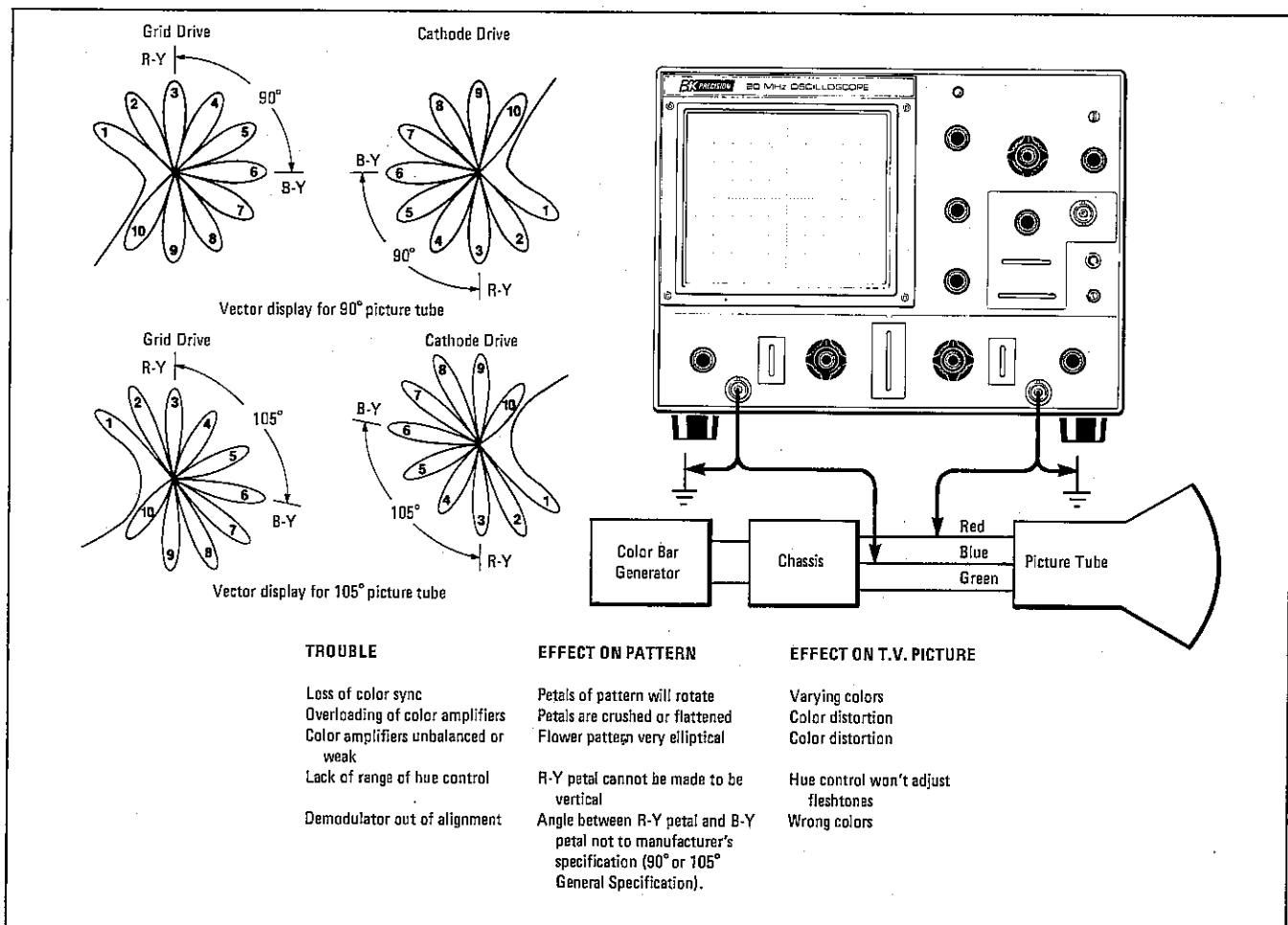

Fig. 21A. Vectorscope operation and patterns.

control changes the position of the petals but not their amplitude. Lastly, 105° sets will have a more elliptical pattern than 90° sets. The table in Fig. 21A lists some common troubles and their effect on the pattern.

The vector display can be used to check the range of the color set's hue control. It should be possible to rotate the R-Y petal about the vertical axis. At the center of the hue control the R-Y petal should be vertical. If it is not, locate the CHROMA reference oscillator. In most sets this oscillator is transformer-coupled to the demodulators.

A slight touch-up of this transformer is all that is necessary to bring the R-Y petal to a vertical position. Do not attempt to make any adjustments on the chroma bandpass amplifiers. This amplifier is aligned by a sweep generator and cannot in general be aligned by just a vector display.

If the set has adjusted demodulators, the vector display can also be used for demodulator alignment. Follow the manufacturer's alignment procedure to locate the proper coils and instead of counting bars simply adjust for the correct angle between R-Y and B-Y.

CB RADIO APPLICATIONS

INTRODUCTION

The Model 1520 oscilloscope is well-suited for testing, adjusting, and servicing 27 MHz Citizens Band transceivers. Its 20 MHz bandwidth allows calibrated voltage readings in all IF and audio circuits, and accurate time measurements in switching circuits. Because of the smooth roll-off characteristics above 20 MHz, direct measurements in 27 MHz RF circuits are also possible, although voltage readings are uncalibrated. The 10 megohms impedance of the probe should not affect circuit operation except in highly sensitive circuits.

It is also important to note that compression of vertical deflection may occur when viewing frequencies above the frequency rating of the oscilloscope. To insure that modulation compression and distortion observations are accurate and not errors introduced by oscilloscope performance, do not exceed four divisions of deflection when observing waveform amplitudes at 27 MHz. To determine exactly the maximum linear oscilloscope deflection at the frequency of interest, monitor an amplitude modulated waveform. Slowly increase the oscilloscope deflection by use of the vertical attenuator and vernier and note the deflection at which compression of the modulation peaks occurs. This is the maximum usable deflection at the frequency under test.

TRANSMITTER MODULATION

The most reliable method of checking transmitter modulation is with an oscilloscope. Fig. 22 shows the typical method of measurement and interpretation of the modulation envelope for AM CB transmitters. Most transceivers include some type of protection against over-modulation, which has no effect until modulation exceeds at least 75%, then progressively compresses any increase in audio amplitude. The effectiveness of this compression-type circuit and the degree of resultant distortion can be measured on the oscilloscope.

Fig. 23 shows how to check SSB modulation. Apply two simultaneous, equal-amplitude audio signals for modulation, such as 500 Hz and 2400 Hz. The audio signals must be free from distortion, noise and transients. The two audio signals should not have a direct harmonic relationship such as 500 Hz and 1500 Hz. The modulation envelope resembles the 100% AM modulation envelope, except the amplitude of the entire waveform varies with the strength of the audio signal. When peak SSB power output is reached, the modulation envelope "flat tops," that is, the instantaneous RF peaks reach the saturation, even with less than peak audio signal applied. This over-modulated condition results in distortion.

The audio modulating signal should be used as the sync trigger to obtain a synchronized display. This can be obtained by selecting EXT source and connecting a cable from the EXT TRIG jack to the audio generator, or connecting a demodulator probe from the EXT TRIG jack to the RF output of the transmitter.

OTHER CB MEASUREMENTS

Some of the additional applications for this oscilloscope in transceivers follow:

- Transmitter carrier signal analysis.
- RF and IF gain measurements (dual-trace display preferred).
- Audio distortion measurements (dual-trace display preferred).
- Audio frequency response check.
- Modulation limiting attack time check (dual-trace display preferred).
- Bandpass filter, notch filter, low-pass or high-pass filter frequency response check, including SSB suppressed carrier filter (sweep generator method preferred).
- Synthesizer circuit analysis and troubleshooting. Dual-trace display preferred for digital phase-locked-loop (PLL) type synthesizer.
- Noise blanker circuit analysis and troubleshooting.
- Signal attenuation measurements.
- Isolating sources of noise, ripple, or transients.
- Signal tracing.

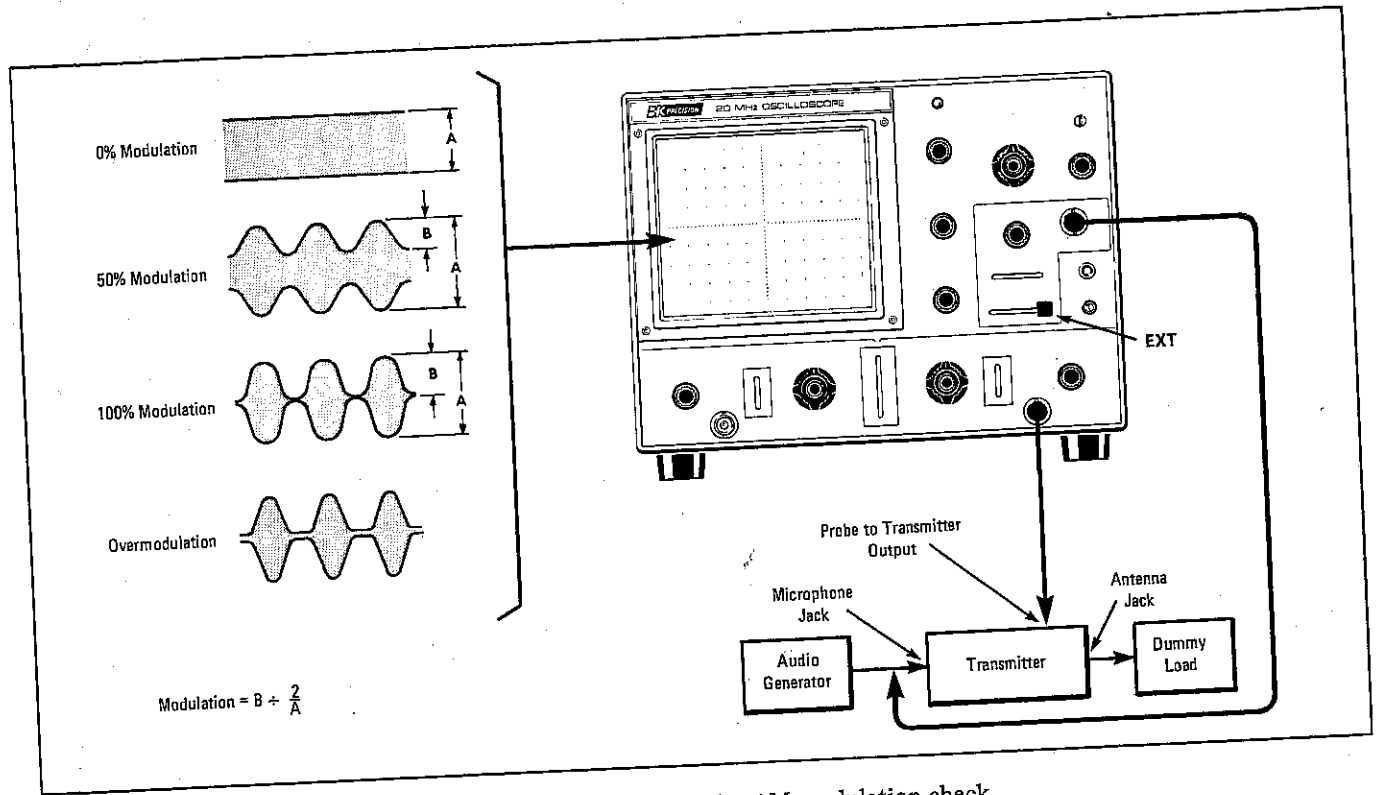

Fig. 22. Typical test set-up for AM modulation check.

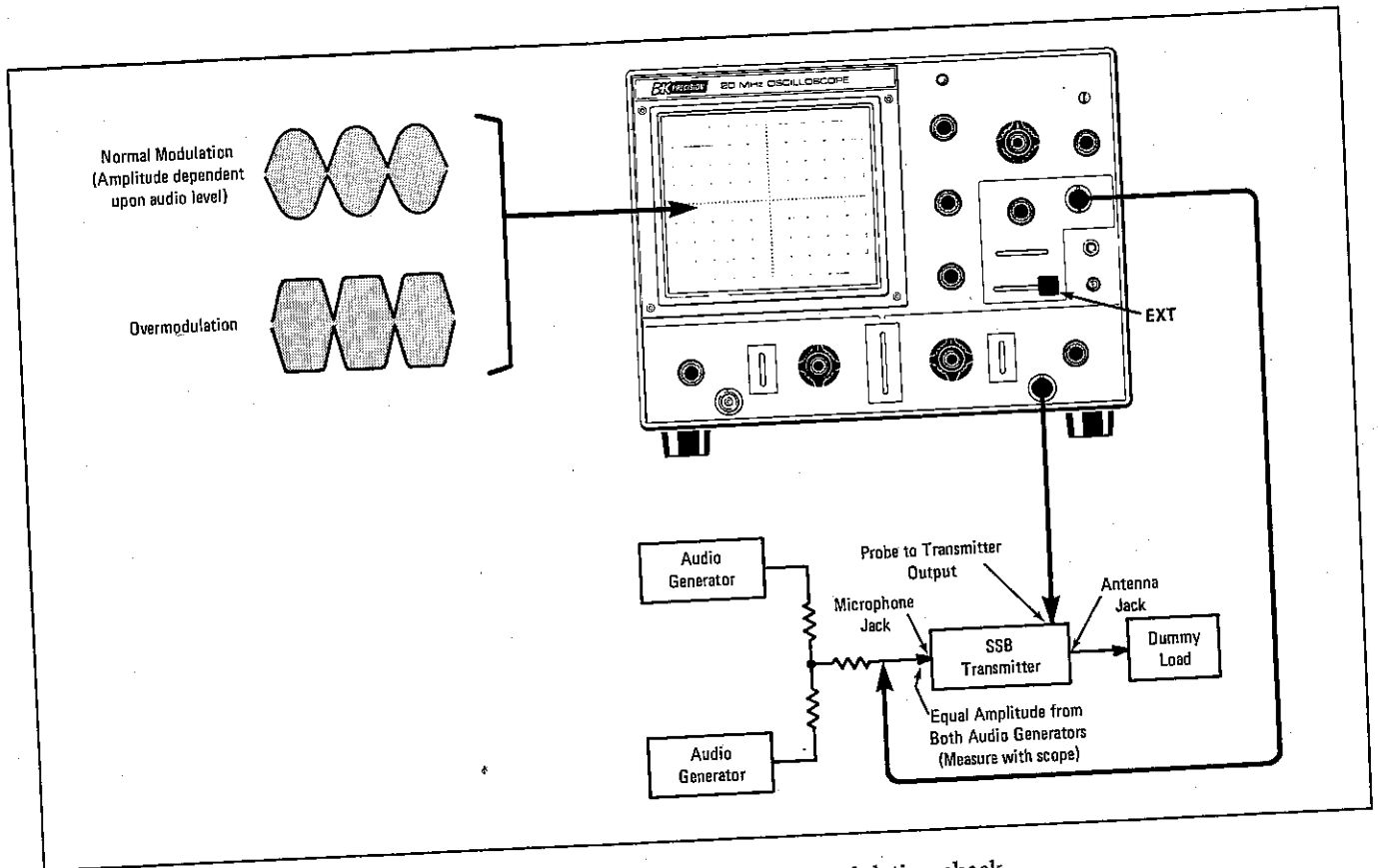

Fig. 23. Typical test set-up for SSB modulation check.

COMMUNICATIONS RADIO APPLICATIONS

This oscilloscope is also excellent for servicing two-way communications transceivers, receivers and transmitters. For radios that operate on carrier frequencies up to at least 30 MHz, the oscilloscope is capable of direct measurement, although voltage readings are uncalibrated. IF signals can be measured without using a demodulator probe. Most of the

checks and measurements described for CB transceivers are applicable to other types of communications equipment. For measurements in circuits above 30 MHz, use a demodulator probe. Only the modulation envelope of amplitude modulated or single sideband modulated RF signals will be displayed.

STEREO AMPLIFIER SERVICING

Another convenient use for dual-channel oscilloscopes is in troubleshooting stereo amplifiers. If identical channel amplifiers are used and the output of one is weak, distorted or otherwise abnormal, the dual-trace oscilloscope can be efficiently used to localize the defective stage. With an identical signal applied to the inputs of both amplifiers, a

side-by-side comparison of both units can be made by progressively sampling identical signal points in both amplifiers. When the defective or malfunctioning stage has been located, the effects of whatever troubleshooting and repair methods are employed can be observed and analyzed immediately.

AMPLIFIER PHASE SHIFT MEASUREMENTS

Phase measurements can be made by several methods using oscilloscopes. Typical applications are in circuits designed to produce a specific phase shift, and measurement of phase shift distortion in audio amplifiers and networks. In all amplifiers, a phase shift is always associated with a change in amplitude response. For example, at the -3 dB response points, a phase shift of 45° occurs.

Phase measurements can be performed by operating the oscilloscope either in the dual-trace mode or the X-Y mode. The first method described uses the dual-trace mode to measure amplifier phase shift directly. Fig. 24 illustrates this method. In this particular case, the measurements are being made at approximately 500 Hz. The input signal to the audio amplifier is used as a reference and is applied to the CH A INPUT jack.

The sweep time VARIABLE control is adjusted as required to provide a complete cycle of the input waveform display on 8 divisions horizontally. A waveform height of 2 divisions is used. The 8 division display represents 360° at the displayed frequency and each centimeter represents 45° of the waveform. The signal developed across the output of the audio amplifier is applied to the Channel B INPUT jack. The vertical attenuator controls of Channel B are adjusted as required to produce a peak-to-peak waveform of 2 divisions as shown in Fig. 24B.

The CH B POSITION control is then adjusted so that the Channel B waveform is displayed on the same horizontal axis as the Channel A waveform as shown in Fig. 24B. The distance between corresponding points on the horizontal axis for the two waveforms then represents the phase shift between the two waveforms. In this case, the zero crossover points of the two waveforms are compared. It is shown that a difference of 1 division exists. This is then interpreted as a phase shift of 45° .

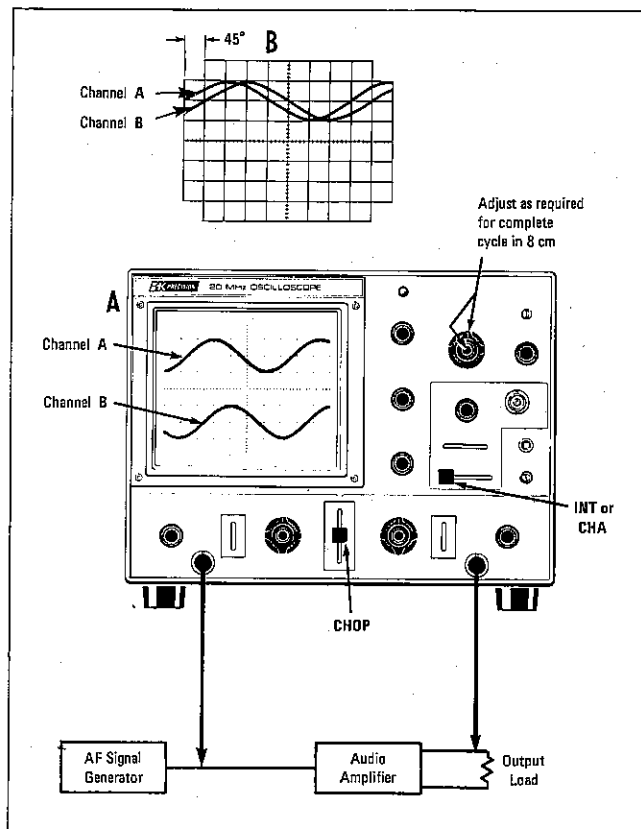

Fig. 24. Measuring amplifier phase shift.

A sine wave input is applied to the audio circuit being tested. The same sine wave input is applied to the vertical input of the oscilloscope, and the output of the tested circuit is applied to the horizontal input of the oscilloscope. The amount of phase difference between the two signals can be calculated from the resulting waveform.

To make phase measurements, use the following procedure starting with the test set-up of Fig. 24.

1. Using an audio signal generator with a pure sinusoidal signal, apply a sine wave test signal at the desired test frequency to the audio network being tested.
2. Set the signal generator output for the normal operating level of the circuit being tested. If desired, the circuit's output may be observed on the oscilloscope. If the test circuit is overdriven, the sine wave display on the oscilloscope is clipped and the signal level must be reduced.
3. Connect the Channel B probe to the output of the test circuit.
4. Set the SWEEP TIME/CM control to CH B. This selects the X-Y mode of operation.
5. Connect the Channel A INPUT probe to the input of the test circuit. (The input and output test connections to the vertical and horizontal oscilloscope inputs may be reversed.)
6. Adjust the Channel A and B gain controls for a suitable viewing size.

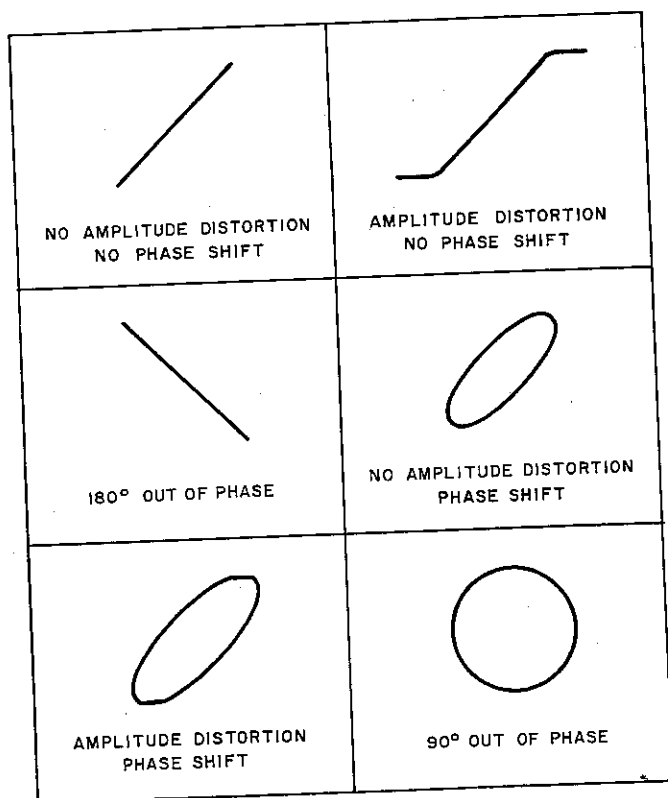

Fig. 25. Typical phase measurement oscilloscope displays.

7. Some typical results are shown in Fig. 25. If the two signals are in phase, the oscilloscope trace is a straight diagonal line. If the vertical and horizontal gain are properly adjusted, this line is at a 45° angle.

A 90° phase shift produces a circular oscilloscope pattern.

Phase shift of less (or more) than 90° produces an elliptical oscilloscope pattern. The amount of phase shift can be calculated from the oscilloscope trace as shown in Fig. 26.

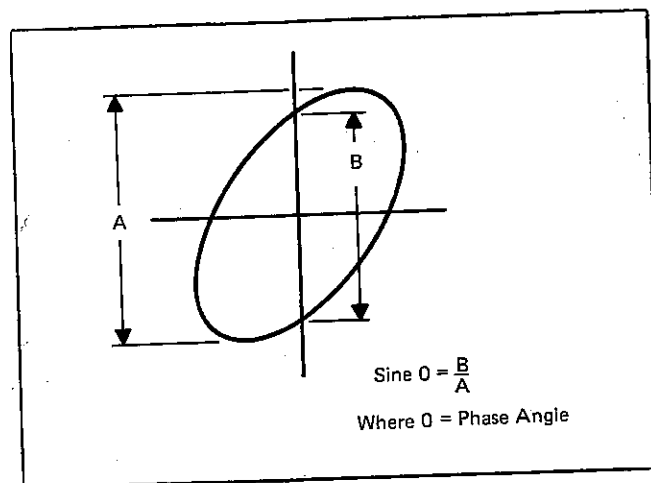

Fig. 26. Phase shift calculation.

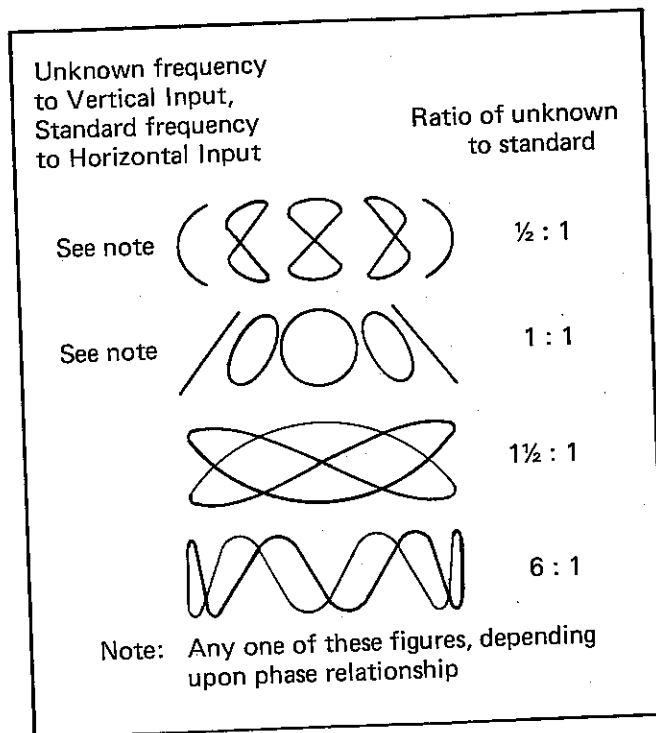

Fig. 27. Lissajous waveforms used for frequency measurement.

FREQUENCY MEASUREMENT

1. Connect the sine wave of known frequency to the CH B INPUT jack of the oscilloscope and set the SWEEP TIME/CM control to CH B. This provides external horizontal input.
2. Connect the vertical input probe (CH A INPUT) to the unknown frequency.
3. Adjust the Channel A and B size controls for a convenient, easy-to-read size of display.
4. The resulting pattern, called a Lissajous pattern, shows the ratio between the two frequencies. See Fig. 27.

SQUARE WAVE TESTING OF AMPLIFIERS

INTRODUCTION

A square wave generator and a low-distortion oscilloscope, such as this instrument, can be used to display various types of distortion present in electronic circuits. A square wave of a given frequency contains a large number of odd harmonics of that frequency. If a 500 Hz square wave is injected into a circuit, frequency components of 1.5 kHz, 2.5 kHz, 3.5 kHz, also are provided. Since vacuum tubes and transistors are non-linear, it is difficult to amplify and reproduce a square wave which is identical to the input signal. Interelectrode capacitances, junction capacitances, stray capacitances as well as limited device and transformer response are a few of the factors which prevent faithful reproduction of a square wave signal. A well-designed amplifier can minimize the distortion caused by these limitations. Poorly designed or defective amplifiers can introduce distortion to the point where their performance is unsatisfactory.

As stated before, a square wave contains a large number of odd harmonics. By injecting a 500 Hz sine wave into an amplifier, we can evaluate amplifier response at 500 Hz only, but by injecting a square wave of the same frequency we can determine how the amplifier would respond to input signals from 500 Hz up to the 15th or 21st harmonic.

The need for square wave evaluation becomes apparent if we realize that some audio amplifiers will be required during normal use to pass simultaneously a large number of different frequencies. With a square wave, we have a controlled signal with which we can evaluate the input and output quality of a signal of many frequencies (harmonics of the square wave) which is what the amplifier sees when amplifying complex waveforms of musical instruments or voices.

The square wave output of the signal generator must be extremely flat so that it does not contribute to any distortion that may be observed when evaluating amplifier response. The oscilloscope vertical input should be set to DC as it will introduce the least distortion, especially at low frequencies. When checking amplifier response, the frequency of the square wave input should be varied from the low end of the amplifier bandpass up toward the upper end of the bandpass; however, because of the harmonic content of the square wave, distortion will occur before the upper end of the amplifier bandpass is reached.

It should be noted that the actual response check of an amplifier should be made using a sine wave signal. This is

especially important in limited bandwidth amplifiers (voice amplifiers). The square wave signal provides a quick check of amplifier performance and will give an estimate of overall amplifier quality. The square wave also will reveal some deficiencies not readily apparent when using a sine wave signal. Whether a sine wave or square wave is used for testing the amplifier, it is important that the manufacturer's specifications on the amplifier be known in order to make a better judgment of its performance.

The test set-up of Fig. 28 is used. Note that a cable terminating resistor is used at the amplifier input to eliminate ringing caused by input mismatch. The quality of the input waveform can be monitored with the oscilloscope. Fig. 29 illustrates the possible response waveforms obtained and an evaluation of each.

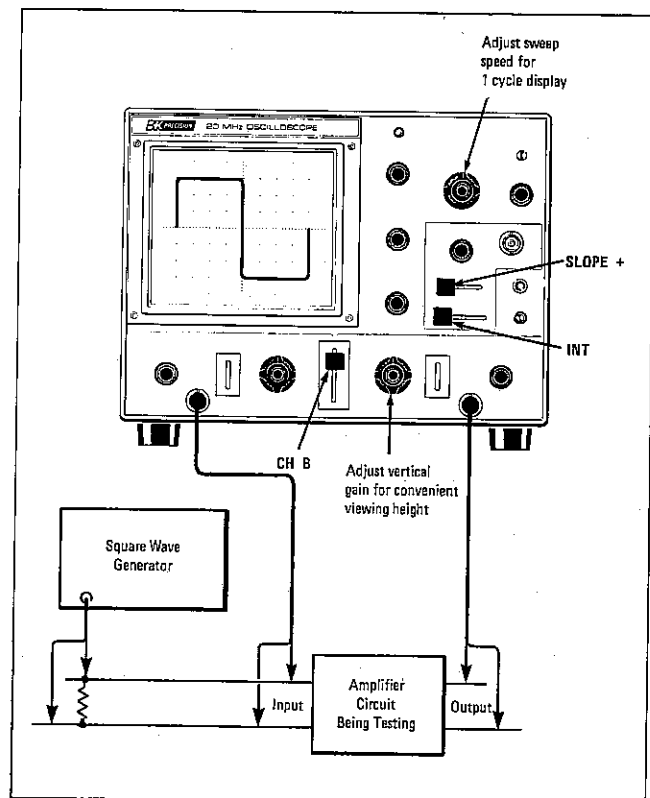

Fig. 28. Equipment set-up for square-wave testing of amplifiers.

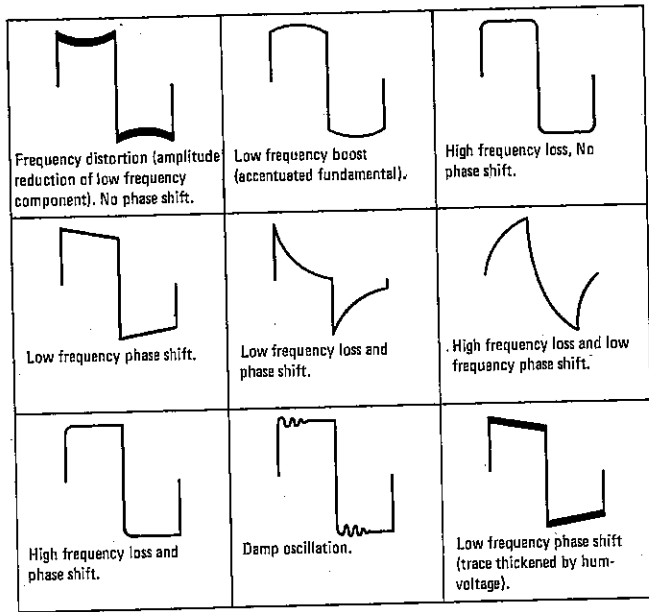

Fig. 29. Summary of waveform analysis for square-wave testing of amplifiers.

MAINTENANCE AND CALIBRATION

WARNING

High voltage up to 2000 volts DC is present on the CRT and power supply board when the oscilloscope is operating. Up to 170 volts DC is present on time base board. Line voltage (120 or 240 VAC) is present on the power transformer, on-off switch, fuse holder, and line voltage selector assembly any time the oscilloscope is connected to an AC power source, even if turned off. Always observe caution when the housing is removed from the unit. Contacting exposed high voltage could result in fatal electric shock.

REMOVING THE CASE

The case is removed in two sections as shown in Fig. 30. The top section can be lifted off after removing seven Phillips-head screws from the top and sides of the case. The bottom section can be lifted off after removing four Phillips-head screws from the bottom of the case.

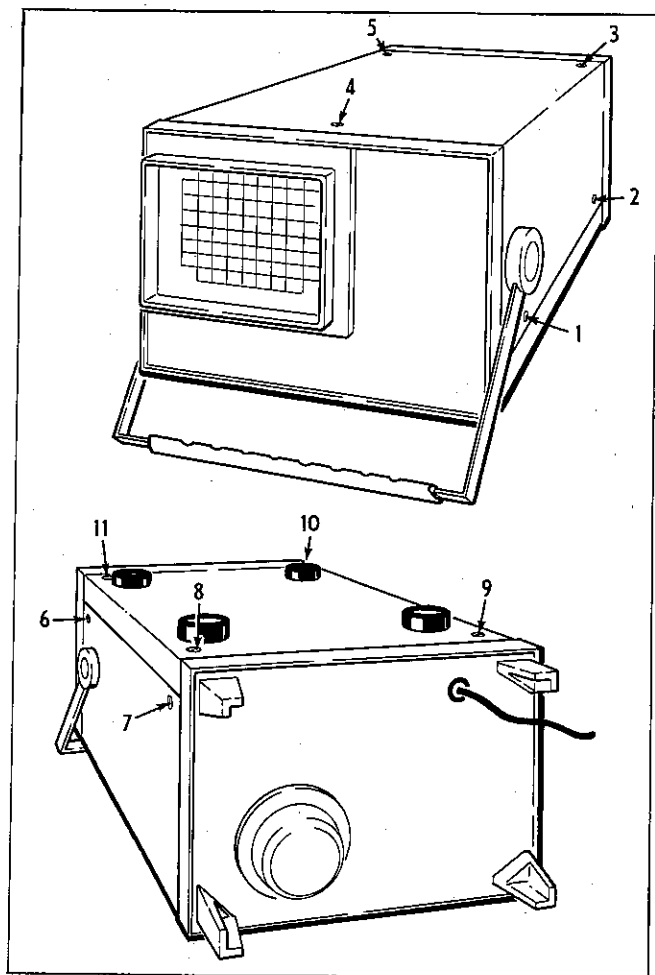

Fig. 30. Removing the case.

FUSE REPLACEMENT

Fuse F1 is in series with the primary of the power transformer. If this fuse blows, the pilot light will go out and the oscilloscope will not operate. The fuse should not normally open unless a problem has developed in the unit. Try to determine and correct the cause of the blown fuse, then replace only with a fast blow fuse of the proper current rating; 0.8 amp for 120 VAC operation or 0.5 amp for 240 VAC operation. The fuse is located on the component side of the time base board as shown in Fig. 31. For access, remove the top section of the case.

120/240 VOLT CONVERSION

This oscilloscope may be operated from either a 120 or 240 VAC, 50/60 Hz power source. Use the following procedure to change from 120- to 240-volt operation or vice versa:

1. Remove top section of case.
2. Remove voltage selector plug P315, which is located on the time base board as shown in Fig. 31.
3. Rotate plug P315 180° and reinsert it.
4. Replace fuse F1 with a fuse of appropriate value; 0.8 amp for 120 VAC operation, 0.5 amp for 240 VAC operation.

The power transformer may also be wired for operation from a 100 VAC or 220 VAC power source. Refer to the schematic diagram and make corresponding wiring changes at connector P314, which is located adjacent to voltage selector plug P315.

Control	Function
VR301	Triggering level
VR303	Slope adjust
VR305	Sweep length adjust
VR306	1 mS sweep time calibrate
VR307	CH B centering adjust
VR309	10X MAG centering adjust
VR310	10X MAG gain adjust
VR312	CAL symmetry adjust
VR313	CAL frequency adjust
VR314	CAL voltage adjust
VR316	Horizontal centering adjust
TC301	1 μ S-50 μ S sweep time calibrate
TC302	0.5 μ S sweep time calibrate
TC303	10X MAG linearity adjust

TABLE I. Functions of adjustments on Time Base board. (See Fig. 31)

BASIC TROUBLESHOOTING CHECKLIST

Be sure to make the following checks before assuming there is a defective component, etc.

1. Pilot light does not glow. CHECK:
 - a. Is scope plugged into "live" outlet?
 - b. Is POWER switch on?
 - c. Is fuse okay?
2. Pilot light glows, but no trace is obtainable. CHECK:
 - a. Is INTENSITY control turned up?
 - b. Is SWEEP TIME/CM switch set to other than CH B position?
 - c. Is sweep triggered? Try centering TRIGGERING LEVEL control, or pull to the PULL AUTO position.
 - d. Are POSITION controls centered? The trace may be deflected entirely off the viewing area of the screen.
3. Trace is obtained, but no waveform display is presented. CHECK:
 - a. Is probe connected? Is probe defective? Try an alternate probe or cable.
 - b. Is AC-GND-DC switch set to GND? Is probe switch set to GND? Try other positions.
 - c. Does MODE switch correspond to INPUT channel? (Is probe connected to Channel A while mode switch is in CH B position?)
 - d. Is vertical attenuation (VOLTS/CM control) set too high or too low? Try other settings.

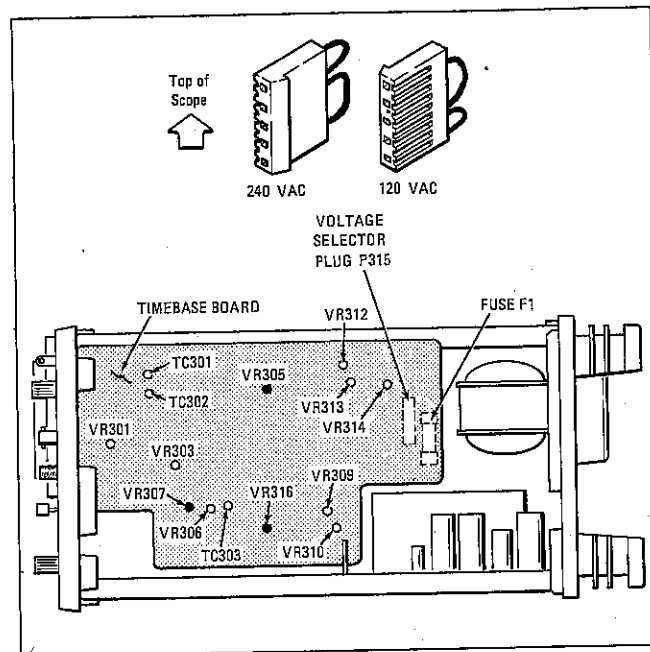

Fig. 31. Fuse, voltage selector, and adjustment locations, right side of scope.

4. Waveform display cannot be synchronized.

Review OPERATING INSTRUCTIONS thoroughly and attempt various control settings that should produce synchronized display.

If the above steps do not correct the problem, the unit may be returned for service as instructed under WARRANTY SERVICE INSTRUCTIONS in this manual.

PERIODIC ADJUSTMENTS

The following operator adjustments only need to be checked and adjusted occasionally. TRACE ROTATION is accessible from the front panel and is adjustable with a flat blade screwdriver. The rest of the adjustments are accessible from the bottom of the oscilloscope without removing the bottom case and are adjustable with a very small flat blade screwdriver. The locations of these adjustments are shown in Fig. 32. To perform adjustments, set scope on its cord wrap/feet (face up).

Trace Rotation

Strong magnetic fields, present in many locations where an oscilloscope may be used, may cause the trace to be tilted. The degree of tilt may vary as the scope is moved from one location to another. The TRACE ROTATION control provides an electrically adjustable offset to compensate for trace tilt. Perform the adjustment as follows:

1. Set oscilloscope controls to produce a horizontal trace with no input signal (PULL AUTO).
2. Use POSITION controls as required to position the trace along a horizontal line of the graticule scale.
3. Adjust TRACE ROTATION so trace is parallel with the reference line on the graticule scale.

Astigmatism

1. Set SWEEP TIME/CM switch to CH B position and Channel A and Channel B AC-GND-DC switches to GND position. This will produce a spot on the screen.
2. With INTENSITY control set about mid-range, adjust both the ASTIG (VR404) and FOCUS controls for the sharpest, roundest spot. Do not readjust ASTIG control after this step.

CAUTION

Never allow a small spot of high brilliance to remain stationary on the screen for more than a few seconds. The screen may be permanently burned.

Control	Function	Control	Function
VR101 VR103 VR105 VR106	CH A step att. balance CH A vari. att. balance CH A gain calibrate 100 kHz square wave compensation	TC104 TC105 TC106 TC107 TC111	CH A 10:1 range square wave compensation CH A 100:1 range square wave compensation CH A 1000:1 range square wave compensation 100 kHz square wave compensation CH B 10:1 range input capacity
VR107 VR111 VR113 VR114 VR116	Vertical centering CH B step att. balance CH B vari. att. balance CH B invert balance CH B gain calibrate	TC112 TC113 TC114 TC115 TC116	CH B 100:1 range input capacity CH B 1000:1 range input capacity CH B 10:1 range square wave compensation CH B 100:1 range square wave compensation CH B 1000:1 range square wave compensation
VR117 TC101 TC102 TC103	Horizontal gain calibrate CH A 10:1 range input capacity CH A 100:1 range input capacity CH A 1000:1 range input capacity	VR401 VR402 VR403 VR404	-10 volts adjust -1.9 kV adjust Blanking adjust ASTIGmatism

Table II. Functions of adjustments on vertical amplifier and power supply boards. (Refer to Fig. 32.)

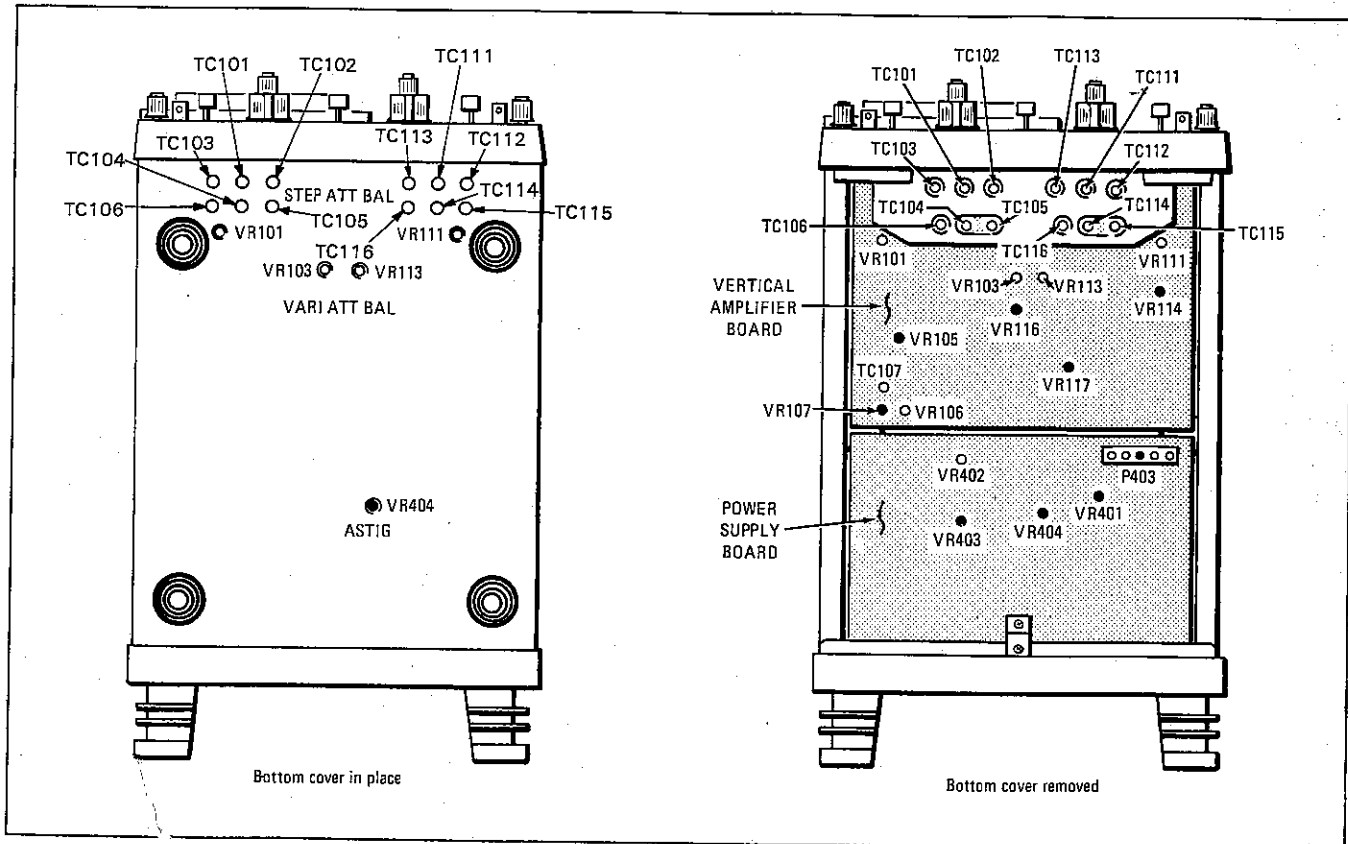



Fig. 32. Location of adjustments, bottom of scope.

DC Balance

1. Set scope controls for a single horizontal trace on Channel A with the Channel A AC-GND-DC switch set to GND position.
2. Rotate the Channel A VARIABLE control from maximum clockwise to maximum counter-clockwise, while observing the trace.
3. If the trace moves vertically, adjust VR101 (STEP ATT. BAL.) for minimum or zero movement when performing step 2.
4. Rotate Channel A VOLTS/CM switch through the 5 mV, 10 mV and 20 mV positions while observing the trace.
5. If the trace moves vertically, adjust VR103 (VARI. ATT. BAL.) for minimum or zero vertical movement when performing step 4.
6. Repeat the entire procedure for Channel B, adjusting VR111 for VOLTS/CM step balance and VR113 for VARIABLE balance.

CALIBRATION CHECK

A general check of calibration accuracy may be made by displaying the output of the CAL  0.1 V p-p terminal on the screen. This test signal has been factory-calibrated to provide an accurate square wave of 0.1 volt peak-to-peak amplitude and 1 millisecond time duration per cycle.

At 20 mV/cm this should produce exactly 5 divisions of vertical deflection on Channel A or Channel B, or 5 divisions of horizontal deflection in X-Y operation when the VARIABLE controls are set to CAL. The 5 mV/cm range may be used to check the 10:1 attenuation of the probe; exactly 2 division of deflection should result.

With a .1 mS/cm sweep time and VARIABLE set to CAL, one cycle of the waveform should occupy exactly 10 divisions. At 1 mS/cm sweep time, 10 cycles should exactly span the 10 divisions, while 1 cycle should cover the 10 divisions using 10X magnification.

CALIBRATION ADJUSTMENTS

The calibration adjustments outlined here are those which can be performed with a minimum of specialized test equipment. Additional adjustments should not be attempted without complete service information and specified test equipment. Requests for complete service information for this oscilloscope should be addressed to:

Service Department
B & K-Precision Test Equipment
DYNASCAN CORPORATION
2815 W. Irving Park Road
Chicago, Illinois 60618

Internal adjustments outlined in the calibration procedure can be located by reference to Fig. 31 and 32.

-10 Volt Adjustment

1. Connect a DC voltmeter to measure the voltage at P403, pin 3 with respect to the chassis.
2. Adjust VR401 for a -10 volt reading on the voltmeter.

Blanking Voltage Adjustment

1. Pull the PULL AUTO knob to display a horizontal trace.
2. Adjust VR403 so that the trace disappears when the INTENSITY control setting is reduced to the 9 to 11 o'clock position.

Vertical Centering Adjustment

1. Set the Channel A POSITION control to its mechanical center position.
2. Set the MODE switch to the CH A position, and the Channel A AC-GND-DC switch to the GND position.
3. Pull the PULL AUTO knob to display a trace.
4. Adjust VR107 to center the trace vertically.

Channel B Invert Balance Adjustment

1. Set the MODE switch to the CH B position and the Channel B AC-GND-DC switch to the GND position.
2. Pull the PULL AUTO knob to display a trace.
3. Alternately pull and push the Channel B PULL INVERT knob, adjusting VR114 so that the trace does not shift when the polarity is reversed.

Sweep Length Adjustment

1. Pull the PULL AUTO knob to display a trace.
2. Adjust the  POSITION control so that the trace starts at the left edge of the graticule scale.
3. Adjust VR305 so that the trace length slightly exceeds 10 divisions.

Horizontal Centering Adjustment

1. Set the  POSITION control to its mechanical center position.
2. Pull the PULL AUTO knob to display a trace.
3. Adjust VR316 so that the trace begins at the left edge of the graticule scale.
4. Next, set the SWEEP TIME/CM switch to the CH B position to select X-Y operation. The trace will disappear and a spot will appear.
5. Adjust VR307 to center the spot horizontally.

Vertical Gain Calibration

1. Set the MODE switch to the CH A position.

2. Connect the Channel A INPUT to the CAL  0.1 V p-p terminal.
3. Set the Channel A VARIABLE control to the CAL position and the VOLTS/CM switch to 20 mV (probe set for DIRECT measurement).
4. Adjust VR105 for exactly 5 divisions vertical amplitude of the square wave signal display.
5. Perform the equivalent of steps 1 thru 4 for Channel B, adjusting VR116 for exactly 5 divisions vertical amplitude of the square wave signal display.

Horizontal Gain Calibration

1. Set the SWEEP TIME/CM switch to the CH B position to select X-Y operation.
2. Connect the Channel B INPUT to the CAL  0.1 V p-p terminal.
3. Set the Channel B VARIABLE control to the CAL position and the VOLTS/CM switch to 20 mV (probe set for DIRECT measurement).
4. The display will appear as two spots connected by a faint trace. Adjust VR117 for exactly 5 divisions horizontal deflection (dots are 5 divisions apart).

WARRANTY SERVICE INSTRUCTIONS

1. Refer to the MAINTENANCE section of your B & K-Precision instruction manual for adjustments that may be applicable.
2. If the above-mentioned procedures do not correct the problem you are experiencing with your unit, pack it securely (preferably in the original carton or double-packed). Enclose a letter describing the problem and include your name and address. Deliver to, or ship PREPAID (UPS preferred) to the nearest B & K-Precision authorized service agency (see list enclosed with unit).

If your list of authorized B & K-Precision service agencies has been misplaced, contact your local distributor for the name of your nearest service agency, or write to:

Service Department

B & K-Precision Product Group
DYNASCAN CORPORATION
2815 West Irving Park Road
Chicago, Illinois 60618

LIMITED ONE-YEAR WARRANTY

DYNASCAN CORPORATION warrants to the original purchaser that its B & K-PRECISION product, and the component parts thereof, will be free from defects in workmanship and materials for a period of one year from the date of purchase.

DYNASCAN will, without charge, repair or replace, at its option, defective product or component parts upon delivery to an authorized B & K-PRECISION service contractor or the factory service department, accompanied by proof of the date of purchase in the form of a sales receipt.

To obtain warranty coverage, this product must be registered by completing and mailing the enclosed warranty registration card to DYNASCAN, B & K-PRECISION, P.O. Box 35080, Chicago, Illinois 60635 within five (5) days from the date of purchase.

Exclusions: This warranty does not apply in the event of misuse or abuse of the product or as a result of unauthorized alterations or repairs. It is void if the serial number is altered, defaced or removed.

DYNASCAN shall not be liable for any consequential damages, including without limitation damages resulting from loss of use. Some states do not allow limitation of incidental or consequential damages, so the above limitation or exclusion may not apply to you.

This warranty gives you specific rights and you may also have other rights which vary from state to state.

For your convenience we suggest you contact your B & K-PRECISION distributor, who may be authorized to make repairs or can refer you to the nearest service contractor. If warranty service cannot be obtained locally, please send the unit to B & K-PRECISION Service Department, 2815 West Irving Park Road, Chicago, Illinois 60618, properly packaged to avoid damage in shipment.

B+K PRECISION DYNASCAN
CORPORATION

6460 West Cortland Street
Chicago, Illinois 60635