

User Manual

8550 Series

Programmable DC Electronic Loads



Safety Summary

The following safety precautions apply to both operating and maintenance personnel and must be followed during all phases of operation, service, and repair of this instrument.

Before applying power to this instrument:

- Read and understand the safety and operational information in this manual.
- Apply all the listed safety precautions.
- Verify that the voltage selector at the line power cord input is set to the correct line voltage. Operating the instrument at an incorrect line voltage will void the warranty.
- Make all connections to the instrument before applying power.
- Do not operate the instrument in ways not specified by this manual or by B&K Precision.

Failure to comply with these precautions or with warnings elsewhere in this manual violates the safety standards of design, manufacture, and intended use of the instrument. B&K Precision assumes no liability for a customer's failure to comply with these requirements.

Category rating

The IEC 61010 standard defines safety category ratings that specify the amount of electrical energy available and the voltage impulses that may occur on electrical conductors associated with these category ratings. The category rating is a Roman numeral of I, II, III, or IV. This rating is also accompanied by a maximum voltage of the circuit to be tested, which defines the voltage impulses expected and required insulation clearances. These categories are:

Category I (CAT I): Measurement instruments whose measurement inputs are not intended to be connected to the mains supply. The voltages in the environment are typically derived from a limited-energy transformer or a battery.

Category II (CAT II): Measurement instruments whose measurement inputs are meant to be connected to the mains supply at a standard wall outlet or similar sources. Example measurement environments are portable tools and household appliances.

Category III (CAT III): Measurement instruments whose measurement inputs are meant to be connected to the mains installation of a building. Examples are measurements inside a building's circuit breaker panel or the wiring of permanently-installed motors.

Category IV (CAT IV): Measurement instruments whose measurement inputs are meant to be connected to the primary power entering a building or other outdoor wiring.

Electrical Power

This instrument is intended to be powered from a CATEGORY II mains power environment. The mains power should be 115 V RMS or 230 V RMS. Use only the power cord supplied with the instrument and ensure it is appropriate for your country of use.

! WARNING

Do not use this instrument in an electrical environment with a higher category rating than what is specified in this manual for this instrument.

! WARNING

You must ensure that each accessory you use with this instrument has a category rating equal to or higher than the instrument's category rating to maintain the instrument's category rating. Failure to do so will lower the category rating of the measuring system.

Ground the Instrument

! WARNING

To minimize shock hazard, the instrument chassis and cabinet must be connected to an electrical safety ground. This instrument is grounded through the ground conductor of the supplied, three-conductor AC line power cable. The power cable must be plugged into an approved three-conductor electrical outlet. The power jack and mating plug of the power cable meet IEC safety standards.

! WARNING

Do not alter or defeat the ground connection. Without the safety ground connection, all accessible conductive parts (including control knobs) may provide an electric shock. Failure to use a properly-grounded approved outlet and the recommended three-conductor AC line power cable may result in injury or death.

! WARNING

Unless otherwise stated, a ground connection on the instrument's front or rear panel is for a reference of potential only and is not to be used as a safety ground. Do not operate in an explosive or flammable atmosphere.

Environmental Conditions

This instrument is intended to be used in an indoor pollution degree 2 environment. The operating temperature range is 0°C to 40°C and 20% to 80% relative humidity, with no condensation allowed.

Measurements made by this instrument may be outside specifications if the instrument is used in non-office-type environments. Such environments may include rapid temperature or humidity changes, sunlight, vibration and/or mechanical shocks, acoustic noise, electrical noise, strong electric fields, or strong magnetic fields.

⚠ WARNING

Do not operate the instrument in the presence of flammable gases or vapors, fumes, or finely-divided particulates.

The instrument is designed to be used in office-type indoor environments. Do not operate the instrument

- **In the presence of noxious, corrosive, or flammable fumes, gases, vapors, chemicals, or finely-divided particulates.**
 - **In relative humidity conditions outside the instrument's specifications.**
 - **In environments where there is a danger of any liquid being spilled on the instrument or where any liquid can condense on the instrument.**
 - **In air temperatures exceeding the specified operating temperatures.**
 - **In atmospheric pressures outside the specified altitude limits or where the surrounding gas is not air.**
 - **In environments with restricted cooling air flow, even if the air temperatures are within specifications.**
 - **In direct sunlight.**
-

⚠ WARNING

Do not operate instrument if damaged

⚠ WARNING

If the instrument is damaged, appears to be damaged, or if any liquid, chemical, or other material gets on or inside the instrument, remove the instrument's power cord, remove the instrument from service, label it as not to be operated, and return the instrument to B&K Precision for repair. Notify B&K Precision of the nature of any contamination of the instrument.

⚠ WARNING

Hazardous voltages may be present in unexpected locations in circuitry being tested when a fault condition in the circuit exists.

Clean the instrument only as instructed

⚠ WARNING

Do not clean the instrument, its switches, or its terminals with contact cleaners, abrasives, lubricants, solvents, acids/bases, or other such chemicals. Clean the instrument only with a clean dry lint-free cloth or as instructed in this manual. Not for critical applications

Do not touch live circuits

Instrument covers must not be removed by operating personnel. Component replacement and internal adjustments must be made by qualified service-trained maintenance personnel who are aware of the hazards involved when the instrument's covers and shields are removed. Under certain conditions, even with the power cord removed, dangerous voltages may exist when the covers are removed.

WARNING

To avoid injuries, always disconnect the power cord from the instrument, disconnect all other connections (for example, test leads, computer interface cables, etc.), discharge all circuits, and verify there are no hazardous voltages present on any conductors by measurements with a properly-operating voltage-sensing device before touching any internal parts. Verify the voltage-sensing device is working properly before and after making the measurements by testing with known-operating voltage sources and test for both DC and AC voltages.

Do not attempt any service or adjustment unless another person capable of rendering first aid and resuscitation is present.

General Safety

WARNING

Do not insert any object into an instrument's ventilation openings or other openings.

WARNING

This instrument is not authorized for use in contact with the human body or for use as a component in a life-support device or system.

Servicing

WARNING

Do not substitute parts that are not approved by B&K Precision or modify this instrument. Return the instrument to B&K Precision for service and repair to ensure that safety and performance features are maintained.

WARNING

Fuse replacement must be done by qualified service-trained maintenance personnel who are aware of the instrument's fuse requirements and safe replacement procedures. Disconnect the instrument from the power line before replacing fuses. Replace fuses only with new fuses of the fuse types, voltage ratings, and current ratings specified in this manual or on the back of the instrument. Failure to do so may damage the instrument, lead to a safety hazard, or cause a fire. Failure to use the specified fuses will void the warranty.

For continued safe use of the instrument

- Do not place heavy objects on the instrument.
- Do not obstruct cooling air flow to the instrument.
- Do not place a hot soldering iron on the instrument.
- Do not pull the instrument with the power cord, connected probe, or connected test lead.
- Do not move the instrument when a probe is connected to a circuit being tested.

Compliance Statements

Disposal of Old Electrical & Electronic Equipment (Applicable in the European Union and other European countries with separate collection systems)

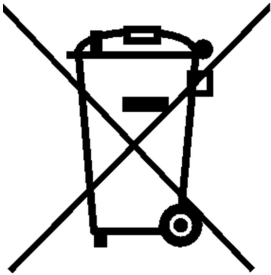

This product is subject to Directive 2002/96/EC of the European Parliament and the Council of the European Union on waste electrical and electronic equipment (WEEE), and in jurisdictions adopting that Directive, is marked as being put on the market after August 13, 2005, and should not be disposed of as unsorted municipal waste. Please utilize your local WEEE collection facilities in the disposition of this product and otherwise observe all applicable requirements.



Safety Symbols











Symbol	Description
	Indicates a hazardous situation which, if not avoided, could result in death or serious injury.
	Indicates a hazardous situation which, if not avoided, will result in minor or moderate injury.
	Refer to the text near the symbol.
	Electric Shock hazard
	Alternating current (AC)
	Chassis ground
	Earth ground
	Indicates the In position of the power switch when instrument is ON.
	Indicates the Out position of the power switch when instrument is OFF.
	Indicates practices not related to physical injury.

Table 1 Safety Symbols

Contents

1	Introduction	11
1.1	Product Overview	11
1.2	Contents	12
1.3	Features	12
1.4	Dimensions	13
1.5	Front Panel	14
1.6	Rear Panel	15
2	Getting Started	16
2.1	Preliminary Information	16
2.2	Input Power and Fuse Requirements	17
2.3	Fuse Replacement	18
3	Basic Front Panel Operation	19
3.1	Function Keys	20
3.1.1	Mode Key	20
3.1.2	System Key	21
3.1.3	Short Key	21
3.1.4	Lock/Local Key & Screenshots	22
3.2	Softkeys	22
4	Modes	23
4.1	Static Mode	24
4.1.1	Constant Current	25
4.1.2	Constant Voltage	26
4.1.3	Constant Resistance	27
4.1.4	Constant Power	28
4.2	Transient Mode	29
4.2.1	Continuous	29
4.2.2	Pulse	30
4.2.3	Toggle	30
4.3	List Mode	31
4.3.1	Continuous List Operation	31
4.3.2	Count List Operation	31
4.3.3	Step List Operation	32
4.3.4	File Configuration	33
4.4	CR-LED Mode	34
4.5	Battery Test Function	35
4.6	Time Test	37

4.7	Over-Current Protection Test (OCPT)	38
4.8	Over-Voltage Protection Test (OVPT)	40
4.9	Over-Power Protection Test (OPPT)	41
4.10	Load Regulation Mode	42
4.11	Sweep Mode	43
4.12	Automatic Test Mode	44
5	System	46
5.1	System Configuration	47
5.1.1	Language	47
5.1.2	Beep Sound	47
5.1.3	Sense	47
5.1.4	Power-On	47
5.1.5	Display	48
5.1.6	Source	49
5.1.7	External Programming	49
5.2	Von/Voff	49
5.3	Protect	50
5.3.1	Over-Voltage Protection	50
5.3.2	Over-Current Protection	50
5.3.3	Over-Power Protection	50
5.3.4	Delay	50
5.4	File Store	51
5.5	Communication Setup	52
5.6	Limit	53
6	Handler	54
6.1	ON Function	55
6.2	TRIG	55
6.3	VF/EXT-PROG	55
6.4	Pass/Fail	55
7	Service Information	56
8	LIMITED THREE-YEAR WARRANTY	57

Introduction

1.1 Product Overview



8550: 150 V / 30 A / 175 W

8551: 150 V / 60 A / 350 W

Figure 1.1 Front View

The 8550 Series DC Electronic Loads are versatile instruments used for static and dynamic testing of DC power supplies, DC-DC converters, batteries, battery chargers, etc.

Primary modes include constant voltage (CV), constant current (CC), constant resistance (CR), and constant power (CW). A wide range of dynamic loading applications can also be simulated through user-programmable slew rates, load levels, duration, and conducting voltage.

Further, transient, list mode, battery mode, and LED modes further extend testing capabilities. Versatile triggering options allow the dynamic load behavior to be synchronized with other events.

The DC load is remotely programmable via the RS 232 serial interface. The serial interface uses a standard 9 pin D type connector. For more information see section RS 232 Interface.

The 8550 Series also provides a handler. This interface can be used to receive external trigger signals, control signals, and output of instrument sorting results.

Model	8550	8551
Voltage Range	0 to 150 V	0 to 150 V
Current Range	0 to 30 A	0 to 60 A
Maximum Power	175 W	350 W

Table 1.1 Models

1.2 Contents

Please inspect the instrument mechanically and electrically upon receiving it. Unpack all items from the shipping carton, and check for any obvious signs of physical damage that may have occurred during transportation. Report any damage to the shipping agent immediately. Save the original packing carton for possible future reshipment. Every DC Load is shipped with the following contents:

1. 1 x 8550 or 8551
2. 1 x AC Power Cord
3. 1 x Certificate of Calibration
4. 1 x Test Report

NOTICE

Ensure the presence of all the items above. Contact the distributor or B&K Precision if anything is missing.

1.3 Features

- CC, CV, CR and CW operation modes.
- Advanced list mode programming
- Transient Mode
- CR-LED: Simulate the test function that the load is LED.
- Battery Mode: Provide battery discharge test, support CC, CR and CP modes.
- Time test: Provide time measurement in basic mode.
- Over-current test (OCPT): Provide over-current protection function test.
- Overvoltage test (OVPT): Provide overvoltage protection function test.
- Overpower Test (OPPT): Provide overpower protection function test.
- Overvoltage protection (OVP), overcurrent (OCP), over temperature (OTP), and includes a key-lock function
- LabVIEW drivers provided

1.4 Dimensions

Model	8550	8551
Dimensions (W x H x D)	9.29" x 4.37" x 17.87" (236 x 111 x 454 mm)	
Weight	6.61 lb. (3 kg)	10.58 lb. (4.8 kg)

Table 1.2 Dimensions and Weight



Figure 1.2 Dimensions

1.5 Front Panel



Figure 1.3 Front Panel

Item	Name	Description
1	Power Button	Toggles the instrument ON or OFF.
2	Function Keys	See section 3.1 for details.
3	USB Host Port	USB port used to connect flash drives.
4	Display	Visual presentation of the device function and measurements.
5	Navigation	Used to navigate menus or configure parameters.
6	Numeric Keypad	Used to enter precise values. (includes \pm and Enter keys)
7	Input Power Button	Toggles the input ON or OFF.
8	Trigger Button	Trigger button for specific functions.
9	Input/Sense	Input channel supporting sheathed banana plugs and spade lug type connector.
10	Softkeys	Used to invoke any functions displayed above them.

Table 1.3 Front Panel

1.6 Rear Panel



Figure 1.4 Rear Panel

Item	Name	Description
1	Input Voltage Switch	Switch between 110/220V±10% AC input.
2	AC power input	Houses the IEC 320 connector.
3	Current Monitoring	Connect an external voltmeter or oscilloscope to display the input's current.
4	RS232 Interface	Connect a cable with a two COM interface (DB9) to remotely control the unit.
5	Handler	Instrument interface signal input and output port.
6	Fuse Housing	Houses the fuse.

Table 1.4 Rear Panel

Getting Started

2.1	Preliminary Information	16
2.2	Input Power and Fuse Requirements	17
2.3	Fuse Replacement	18

2.1 Preliminary Information

Before getting started, please inspect the instrument mechanically and electrically upon receiving it. Unpack all items from the shipping carton, and check for any obvious signs of physical damage that may have occurred during transportation. Report any damage to the shipping agent immediately.

Save the original packing carton for possible future reshipment.

Review Safety Information

This instrument is a Class 1 safety instrument, which means it has a protective earth terminal. That terminal must be connected to earth ground through a power source equipped with a ground receptacle.

Refer to the **Safety Summary** page at the beginning of this guide for general safety information. Before installation or operation, check the DC load and review this guide for safety warnings and instructions. Safety warnings for specific procedures are located at appropriate places throughout this manual.

Observe Environmental Conditions

The environmental conditions of the DC load are documented under **Environmental Conditions**. The unit should only be operated indoors in a controlled environment.

Normal working temperature: 0°C to 40°C and 20% to 90% relative humidity

Reference working temperature: 20°C \pm 8°C and 80% relative humidity

The dimensions of your instrument as well as an outline diagram are also documented under Specifications. A fan cools the load by drawing air through the sides and exhausting it out the side and back. The instrument must be installed in a location that allows sufficient space at the sides and back of the unit for adequate air circulation.



Do not operate the instrument in the presence of flammable gases or fumes.

Safety Requirements

Under the referenced working condition:

- The insulation resistance between the power terminal and the shell must not be less than 50 M.
- During transportation the insulation resistance between the power terminal and the housing must not be less than 2 M.
- The AC voltage between the power terminal and the housing can withstand 1.5 kV at 50 Hz for 1 minute without breakdown or arcing.
- Leakage current will not exceed 3.5 mA.

2.2 Input Power and Fuse Requirements

The AC input on the back of your unit accepts nominal line voltages in the range of 100 ($1 \pm 10\%$) OR 240 ($1 \pm 10\%$) VAC. The frequency can be 50/60 Hz. Ensure the **Input Voltage Switch** located on the rear panel is in corresponding position to match the line voltage.

FIRE HAZARD Use only the power cord that was supplied with your instrument. Using other types of power cords may cause overheating of the power cord, resulting in fire.

WARNING

SHOCK HAZARD The power cord provides a chassis ground through a third conductor. Be certain that your power outlet is of the three-conductor type with the correct pin connected to earth ground.

Before connecting the power cord to the IEC 320 connector on the rear panel of the unit, be sure that the power switch is in the OFF position and verify that the AC power cord, including the extension line, is compatible with the rated voltage/current and that there is sufficient circuit capacity for the DC load. Once verified, connect the cable firmly.

2.3 Fuse Replacement

The fuse is accessible through the rear panel beneath the **Input Voltage Switch**.

Table 2.1 shows the fuse requirements.

Rating	Fuse Specification
110 V / 60 Hz	T2AL
220 V / 50 Hz	T1AL

Table 2.1 Fuse Specification

⚠ WARNING

No power should be applied to the instrument while replacing the fuse. Disconnect all cables connected to the instrument before proceeding.

Fuse Replacement Procedure

- Step 1.** Locate the fuse box in the rear panel beneath the **Input Voltage Switch**. (See [figure 1.4](#))
- Step 2.** Insert a small flathead screwdriver into the slit and rotate it counter clockwise as illustrated in [figure 2.1](#).
- Step 3.** Check the fuse to determine if it must be replaced.



Figure 2.1 Fuse Removal

Basic Front Panel Operation

3.1	Function Keys	20
3.1.1	Mode Key	20
3.1.2	System Key	21
3.1.3	Short Key	21
3.1.4	Lock/Local Key & Screenshots	22
3.2	Softkeys	22

At power-on, the instrument will automatically enter the Static submenu where the core operation modes (CC, CV, CR, and CW) can be selected.

3.1 Function Keys

The **Function Keys** consist of **Mode**, **System**, **Short**, and Lock/Local.

3.1.1 Mode Key

The **Mode Key** enters the **Operation Modes** menus. (Figure 3.1)

The 8550 Series supports the following modes:

- | Menu 1/3 | Menu 2/3 | Menu 3/3 |
|--|---|---|
| <ul style="list-style-type: none"> • Static • Trans • List • CR-LED • Battery | <ul style="list-style-type: none"> • Time Test • OCPT • OVPT • OPPT • Load Reg | <ul style="list-style-type: none"> • Sweep • Auto |

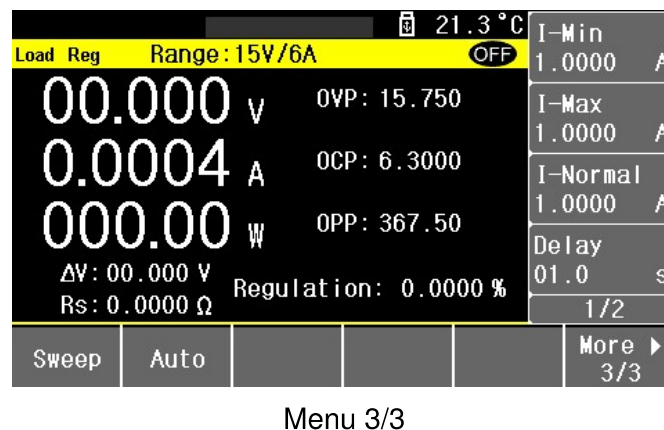
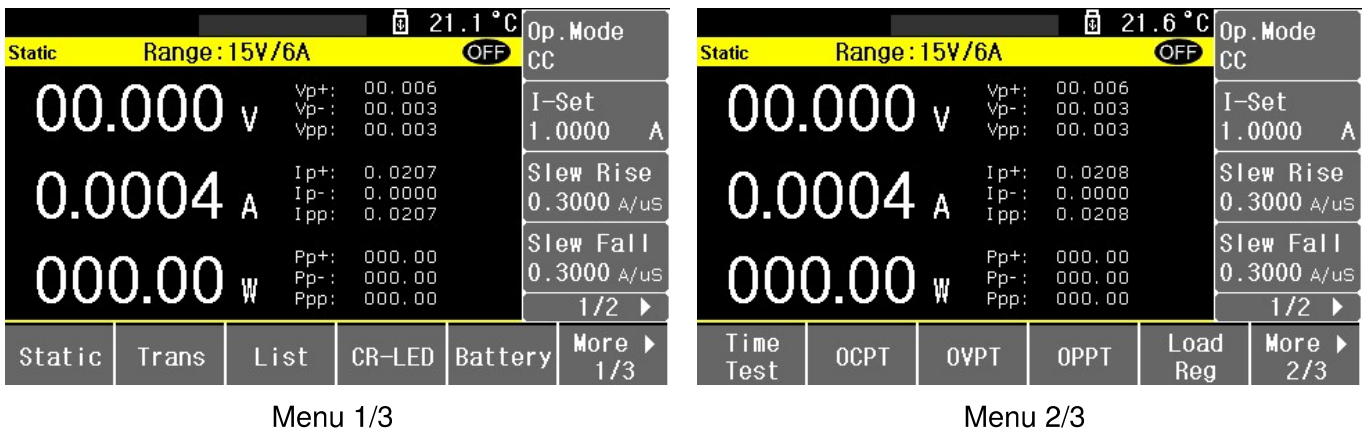

Figure 3.1 Operation Mode Menus

3.1.2 System Key

Pressing the **System Key** enters the system menu where the instrument’s settings can be configured. The following submenus can be found in the **System** menu:

- **System Config**
- **Von/Voff**
- **Protect**
- **File Store**
- **Comm Setup**
- **Limit**

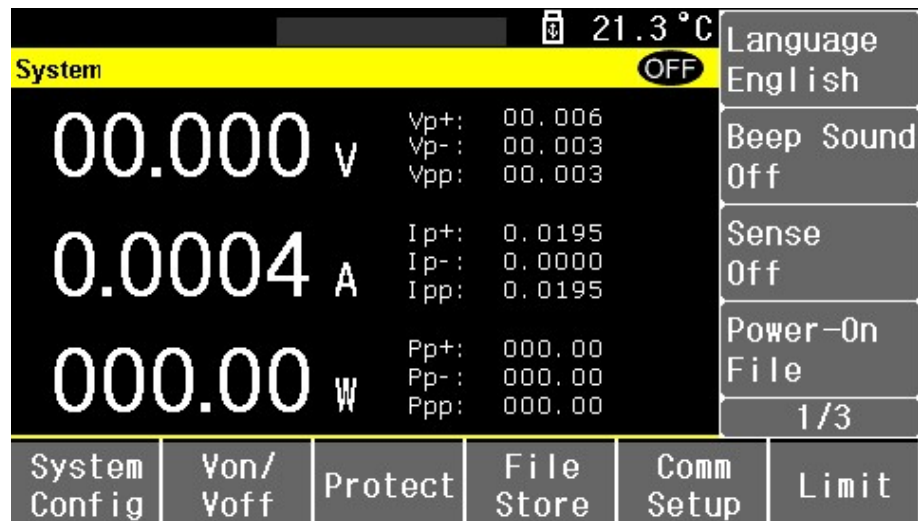

Figure 3.2 System Menu

For more details on each submenu click on the corresponding submenu.

3.1.3 Short Key

The 8550 Series can simulate a short-circuit at the input. This allows for a short-circuit load test up to the maximum current range of the load.

Pressing the **Short** key will enable the short circuit test function by shorting the input terminals. The short circuit test function is not available in CC and CR.

NOTICE

In CC and CR mode the input settings take precedence over the short test.

When short circuit test function is enabled both the LEDs corresponding to the **Short** and **ON** keys will light up (bright blue).

NOTICE

The input on/off and the input protection functions take precedence over an input short.

3.1.4 Lock/Local Key & Screenshots

The **Lock/Local** key toggles the instrument between remote (lock) and local mode. While in remote mode all front panel keys except for **Lock/Local** and **Enter** are unavailable and the LED corresponding to the **Lock/Local** key is illuminated. **Enter** will function as a screenshot key while in remote mode.

To unlock the front panel press the **Lock/Local**.

Screenshots

Screenshots can be taken while the instrument is in remote mode.

To take a screenshot:

- Step 1.** Insert a U disk into the USB interface located in the front panel.
- Step 2.** If in local mode press the **Lock/Local** key to enter remote mode.
- Step 3.** While in remote mode press the **Enter** key.

A save progress indicator will appear in the center top portion of the display. (Figure 3.3)



Figure 3.3 Screenshot Indicator

3.2 Softkeys

There are 6 softkeys located beneath the instruments display. Each key selects the corresponding function located directly above it. Function will vary depending on the selected menu.

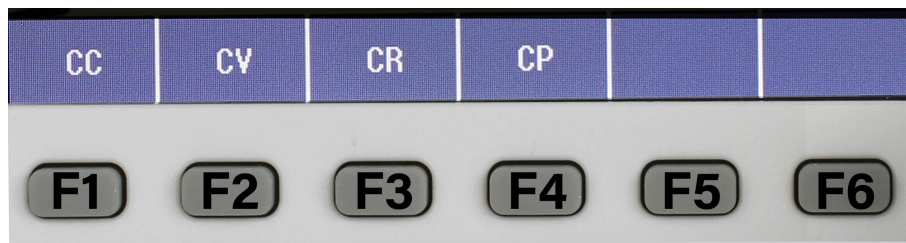

Figure 3.4 Softkeys

NOTICE

To distinguish between each softkey the manual will reference the assigned name shown in Figure 3.4. The **F<#>** is not actually printed onto the softkeys.

Modes

The 8550 series integrates the following modes:

4.1	Static Mode	24
4.1.1	Constant Current	25
4.1.2	Constant Voltage	26
4.1.3	Constant Resistance	27
4.1.4	Constant Power	28
4.2	Transient Mode	29
4.2.1	Continuous	29
4.2.2	Pulse	30
4.2.3	Toggle	30
4.3	List Mode	31
4.3.1	Continuous List Operation	31
4.3.2	Count List Operation	31
4.3.3	Step List Operation	32
4.3.4	File Configuration	33
4.4	CR-LED Mode	34
4.5	Battery Test Function	35
4.6	Time Test	37
4.7	Over-Current Protection Test (OCPT)	38
4.8	Over-Voltage Protection Test (OVPT)	40
4.9	Over-Power Protection Test (OPPT)	41
4.10	Load Regulation Mode	42
4.11	Sweep Mode	43
4.12	Automatic Test Mode	44

To access these modes:

Step 1. Press the **Mode** key to enter the Mode menu.

Step 2. Press the softkey corresponding to the desired mode.

4.1 Static Mode

Static mode includes the main four functions of the DC load; constant current (CC), constant current (CC), constant resistance (CR), and constant power (CW). Once in **Static** mode, select the desired function by pressing the corresponding softkey. The parameters in the Load Settings tab will change accordingly to the selected operating mode.

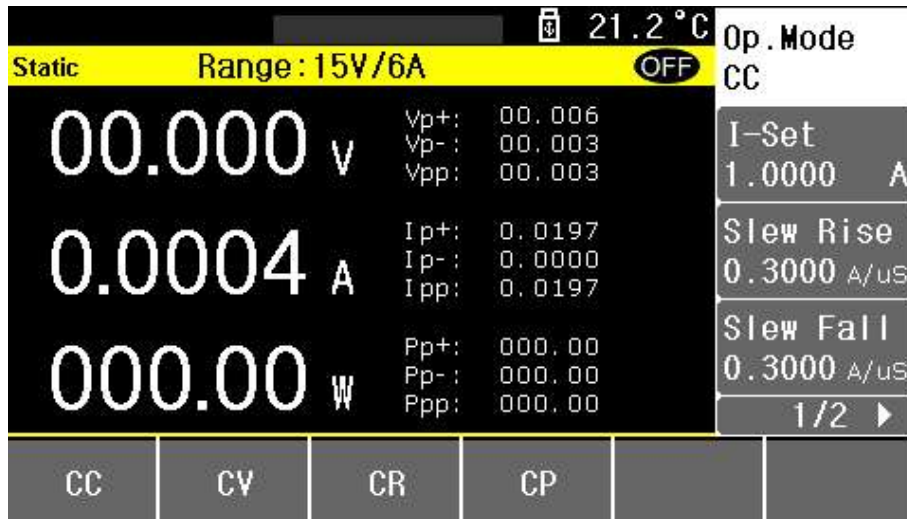

Figure 4.1 Static Mode

When programmed to a mode, the electronic load remains in that mode until another mode is selected or the menu is switched. Therefore, when navigating other menus such as **System** the previously selected mode will not be available.

NOTICE

If the selected mode is in operation it must first be disabled in order to navigate any menu out of **Static** mode. Likewise, the function can only begin operation when the instrument is in **Static** mode.

4.1.1 Constant Current

In constant current mode, the load will sink a current in accordance with the programmed value regardless of the input voltage.

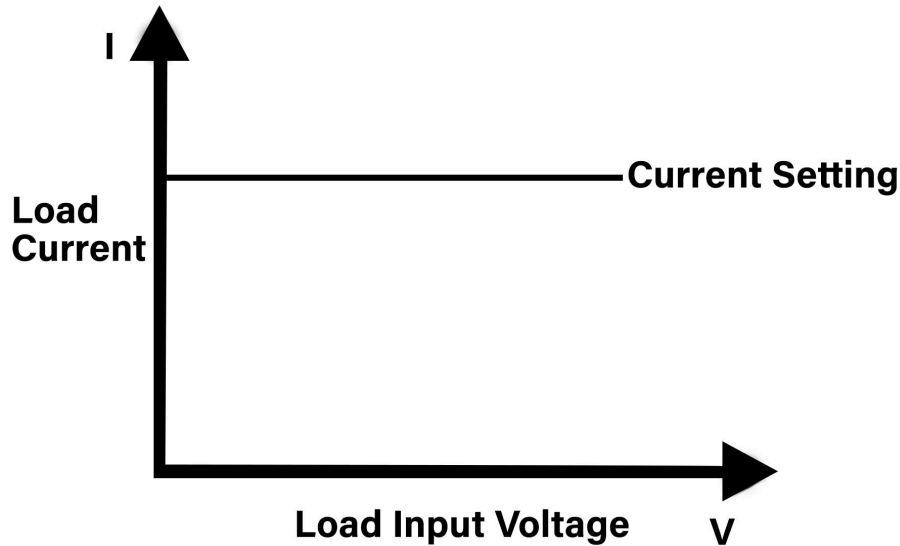

Figure 4.2 CC Mode

Configure CC Parameters

There are several parameters that must be setup properly to operating in CC mode. These parameters are accessible once CC is selected. Use rotary knob to navigate the available parameters.

I-Set

Sets the current value the load will sink. To set the value use the numeric keys, then press **Enter** to enter the value. The knob can also be used to adjust the value.

Slew Rise A/ μ s

Sets the rise slew rate of the load, which determines the rate at which the input current increases to a new programmed value.

Slew Fall A/ μ s

Sets the fall slew rate of the load, which determines the rate at which the input current decreases to a new programmed value.

4.1.2 Constant Voltage

In constant voltage mode the load will sink enough current to control the DUT voltage to the programmed value. The load acts as a shunt voltage regulator when operating in CV mode.

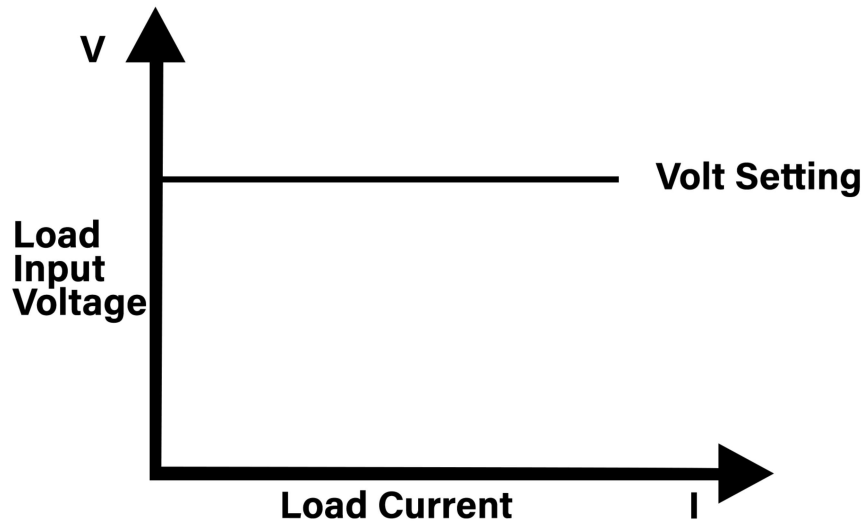

Figure 4.3 CV Mode

Configure CV Parameters

There are several parameters that must be setup properly to operating in CV mode. These parameters are accessible once CV is selected. Use rotary knob to navigate the available parameters.

V-Set

Sets the voltage value the load will maintain. To set the value use the numeric keys, then press **Enter** to enter the value. The knob can also be used to adjust the value.

Slew Rise V/ms

Sets the rise slew rate of the load, which determines the rate at which the input voltage increases to a new programmed value.

4.1.3 Constant Resistance

In constant resistance mode the load will sink a current linearly proportional to the voltage in accordance with the programmed resistance value.

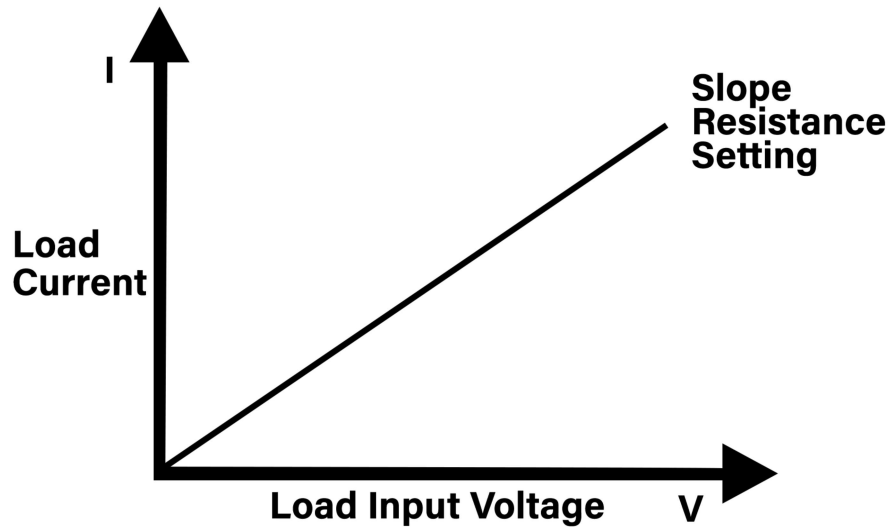

Figure 4.4 CR Mode

Configure CW Parameters

There are several parameters that must be setup properly to operating in CV mode. These parameters are accessible once CR is selected. Use rotary knob to navigate the available parameters.

R-Set

Sets the resistance value the load will maintain. To set the value use the numeric keys, then press **Enter** to enter the value. The knob can also be used to adjust the value.

4.1.4 Constant Power

In constant power mode the load will maintain the input power at the specified programmed power level.

NOTICE

The load has an independent power loop that regulates the input power at the limit setting (175 for model 8550 and 350 for model 8551).

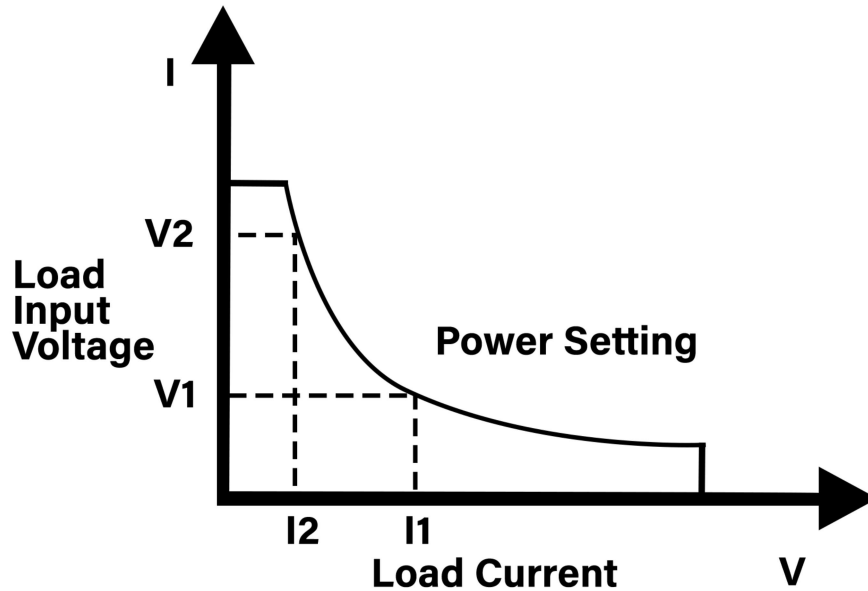

Figure 4.5 CW Mode

Configure CW Parameters

There are several parameters that must be setup properly to operating in CV mode. These parameters are accessible once CW is selected. Use rotary knob to navigate the available parameters.

P-Set

Sets the wattage value the load will maintain. To set the value use the numeric keys, then press **Enter** to enter the value. The knob can also be used to adjust the value.

4.2 Transient Mode

Transient operation enables the module to periodically switch between two load levels. This function allows for dynamic characteristics of power supplies or other DC sources.

Transient testing can be used to check the stability of the source voltage. Transient functions have two current levels denoted as **Level-A** and **Level-B**, which must be in the same range **6 A** or **60 A**. You can set the frequency as well as the duty cycle, which will affect the timing and width of each level. The slew rate determines the rate at which the level changes.

There are three different transient testing modes: continuous, pulse, and toggle.

4.2.1 Continuous

Generates a respective pulse stream that toggles between two load levels. Upon receiving a trigger, and the load will continuously switch between the A/B levels preset. Transient loads are usually used to test the power supply's performance under continuous changing load conditions. **Figure 4.6** shows the current waveform of continuous transient operation mode.

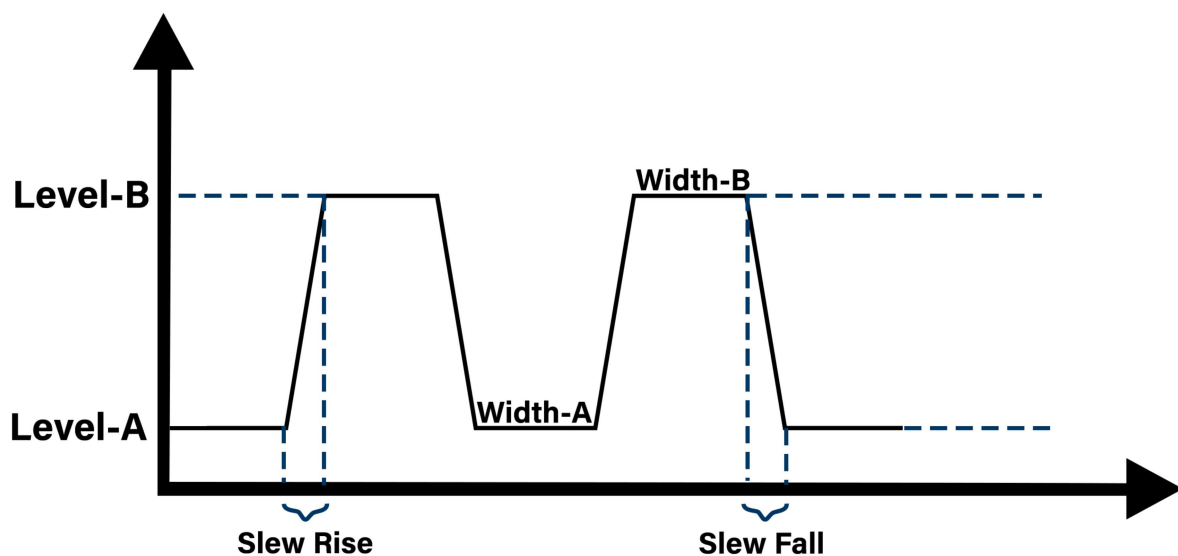

Figure 4.6 Continuous Transient Operation

4.2.2 Pulse

Generates a transient pulse of programmable width when pulse transient operation is in effect.

In pulse mode the electronic load will automatically switch to B level. After maintaining B width time, it will switch to A level. The electronic load will not switch to B level again until the instrument receives a trigger signal. **Figure 4.7** shows the current waveform in pulse transient operation.

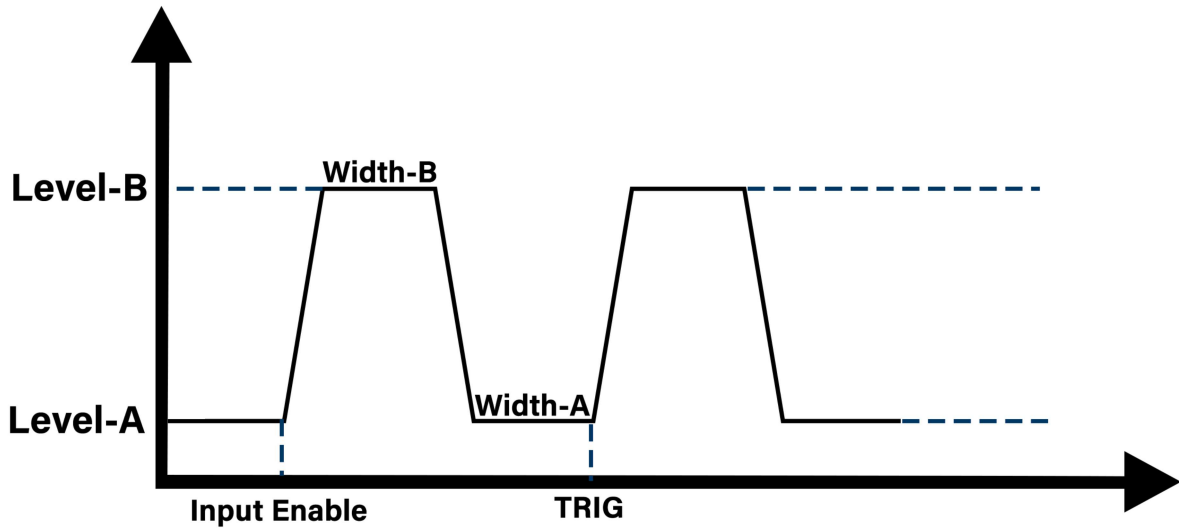

Figure 4.7 Pulse Transient Operation

4.2.3 Toggle

In toggle mode,, the electronic load will switch between Level-A and Level-B when it receives a trigger signal. **Figure 4.8** shows the current waveform in toggle transient operation.

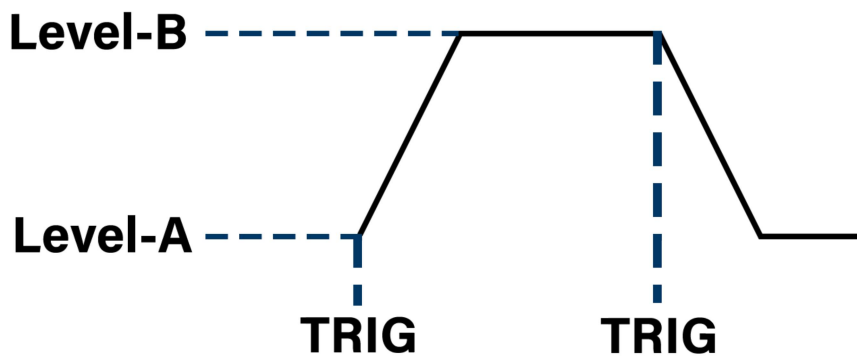

Figure 4.8 Toggle Transient Operation

4.3 List Mode

List mode allows the user to generate complex sequences of input changes with rapid, precise timing. This is useful when running test sequences with a minimum amount of programming overhead.

List steps are continuously loaded according to the sequence edited in the list file. The load supports up to 10 files, each containing up to 100 steps. Each step can configure the current value, duration, and slope.

NOTICE

Files cannot be sequenced to run one after the other. To switch between files the input must first be disabled then the selected file can be configured.

List mode supports 3 configurations: **Continuous**, Count, and Step.

4.3.1 Continuous List Operation

When list is set to continuous the list will repeat all configured steps of the selected file continuously until the input is disabled.

NOTICE

The **Count** parameter does not affect the repeat cycles in continuous mode.

4.3.2 Count List Operation

When list is set to count the selected list will be repeated by the specified number of **Count**. Count can be configured up to 100. Once the list has been repeated the specified number of times the input will automatically be disabled. **Figure 4.9** shows an example of a File containing 8 steps. The count was set to 2, meaning the file repeats twice before the input is disabled.

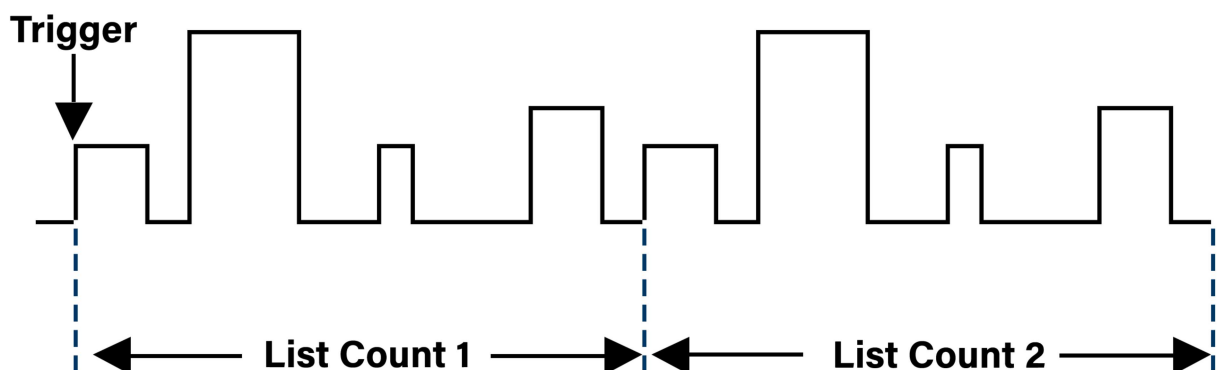

Figure 4.9 Count List Operation

4.3.3 Step List Operation

When list is set to step the next step will not load automatically. Once the dwell time of the step elapses the instrument will remain in that step until a trigger signal is received. Triggering after the last programmed step in the file has elapsed will loop the file back to step 1. The user can loop through the file infinitely regardless of the specified count value.

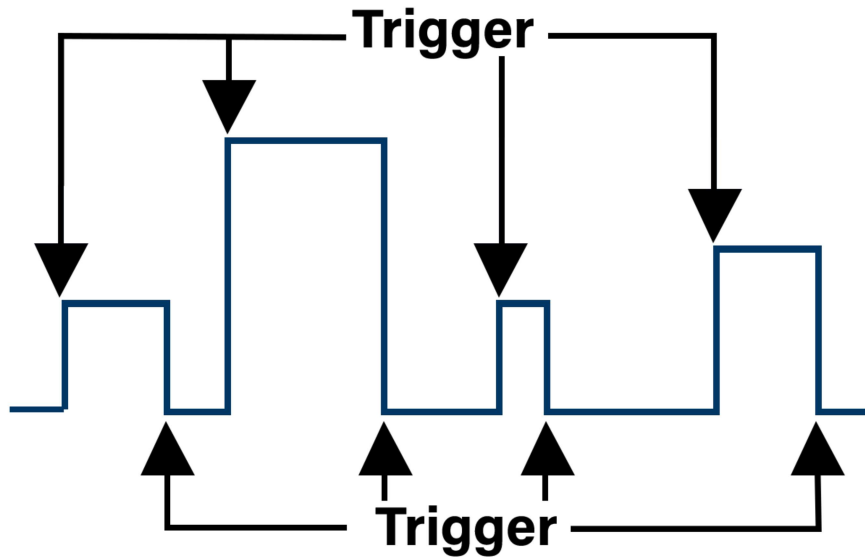

Figure 4.10 Step List Operation

4.3.4 File Configuration

Pressing **Mode** > **F3** > **F1** will display the **List Edit** menu **figure 4.11**.

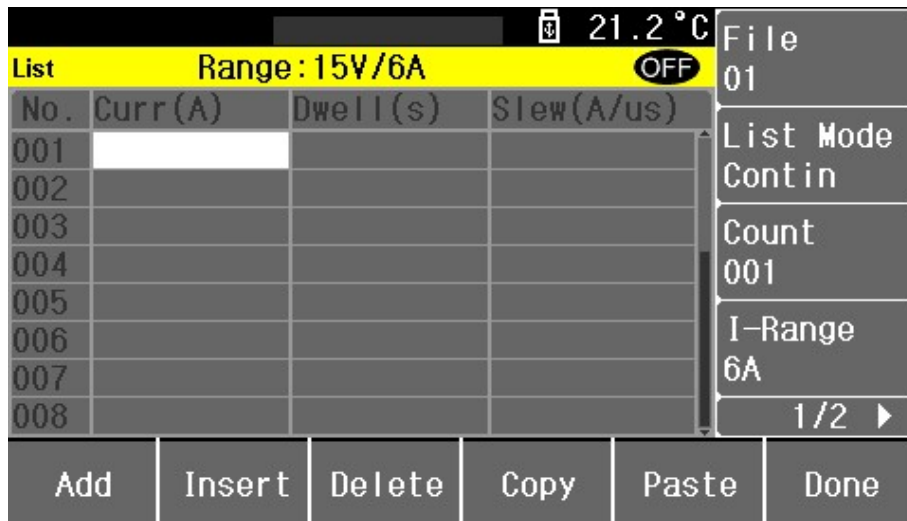

Figure 4.11 File Configuration

In the **List Edit** menu the user can; insert, add, copy, paste, delete, and edit steps. Each step has 3 configurable parameters: **Current**, **Dwell**, and **slew**.

Setting	Description
Current (A)	Sets the current value the load will sink.
Dwell (s)	Sets the dwell time of the selected step. (20 μ /s to 50)
Slew (μ /s)	Sets the rate at which the current changes from one step to the next.

Table 4.1 Step Parameters

4.4 CR-LED Mode

To enter CR-LED mode press **Mode** > **F4**.

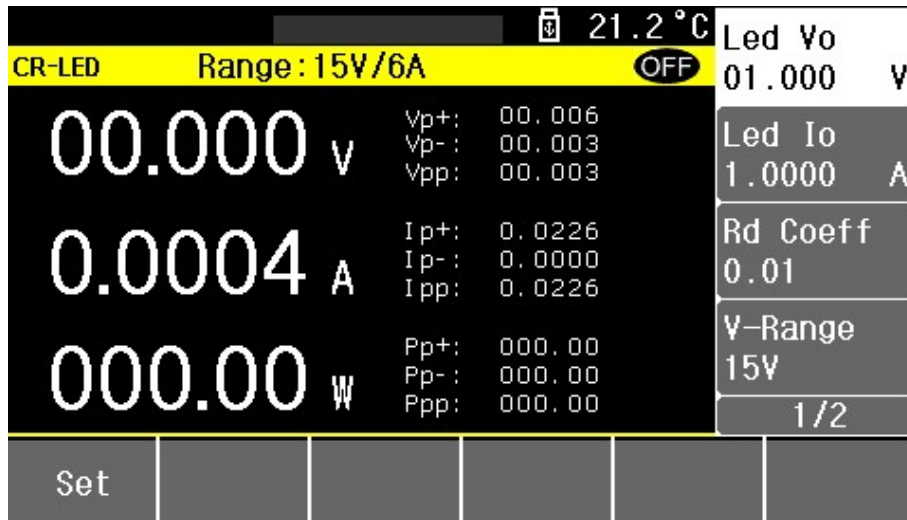

Figure 4.12 CR-LED Menu

CR LED allows the instrument to simulate the loading behavior of typical LEDs, which can be used for testing LED drivers. When the function is enabled, the load allows the user to configure the LED's operating resistance and forward voltage along with the voltage range (same as CR operation). **Figure 4.13** illustrates the V-I characteristics curve of a typical LED.

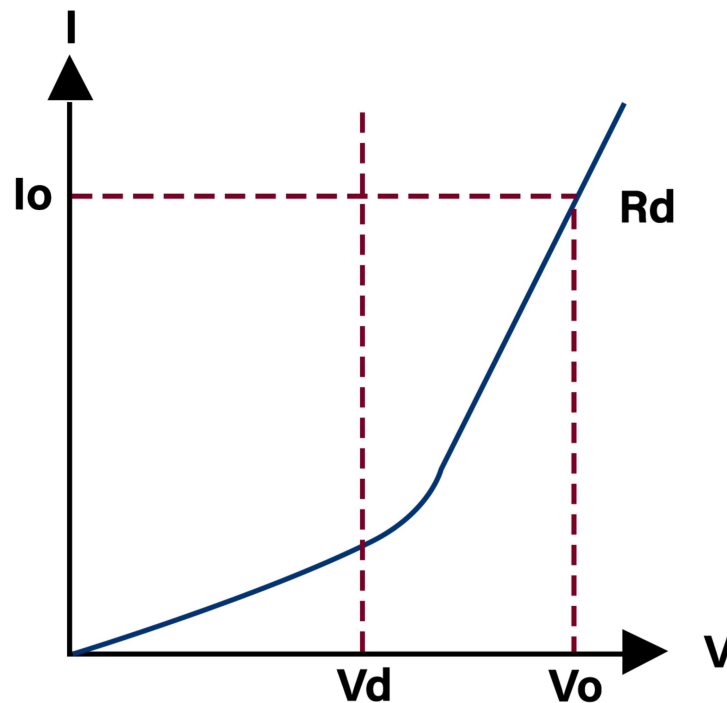

Figure 4.13 CR-LED Mode

- **Vd** = Forward voltage of the LED
- **Rd** = The LED’s operating resistance
- **Vo** = Operating voltage across the LED
- **Io** = Operating current across the LED
- **Rd Coeff** = The ratio of the series equivalent resistance (Rd) and the total equivalent resistance of the LED load (Vo/Io) $Rd\ Coeff = Rd/(Vo/Io)$

The use CR-LED mode only **Vo**, **Io**, and **Rd Coeff** have to be entered.

4.5 Battery Test Function

The 8550 series has a built-in battery test function that supports: **CC**, **CR**, and **CW** mode.

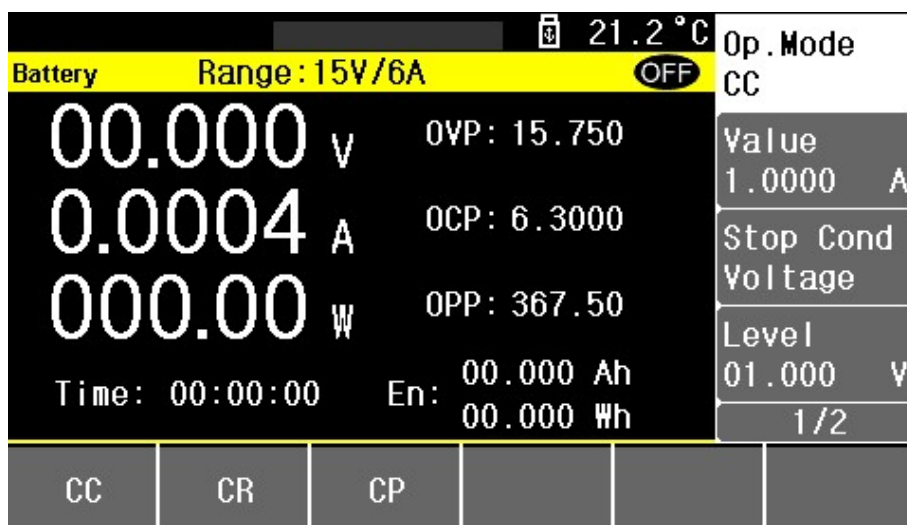

Figure 4.14 Battery Mode

Each mode supports the following stop conditions:

Condition	Description
Voltage (V)	Sets a cut-off voltage level. When this level is reached, the test will end.
Time (ms or s)	Sets a timer. When the specified time is reached, the test will end.
Energy (Ah)	Sets a capacity level. When the calculated Ah capacity reaches this level, this test will end.
Energy (Wh)	Sets a capacity level. When the calculated Wh capacity reaches this level, this test will end.

Table 4.2 Stop Conditions

During operation, the load operates at the specified level according to the selected operation mode, while measuring and updating the capacity value in both amp-hours (Ah) and watt-hour (Wh). The load will also track the test's run time. When the selected stop condition meets the specified level the test will end.

To setup the battery test function:

- Step 1.** Enter Battery Test mode by pressing **Mode** then **F5**.
- Step 2.** Select the desired operation mode by pressing the corresponding softkey.
- Step 3.** Set operation mode level.
- Step 4.** Select a stop condition.
- Step 5.** Set the stop condition level.
- Step 6.** Verify the proper ranges required for your test are selected.

4.6 Time Test

The 8550 series provides a time test function with a test accuracy of .1 ms (100 μ s).

To enter the **Time Test** operation mode press **Mode** > **F6** > **F1**.

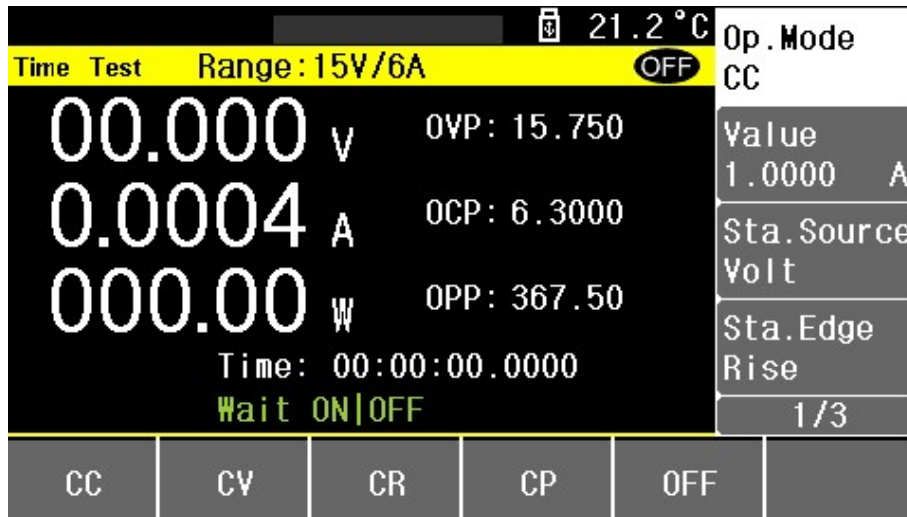

Figure 4.15 Time Test Mode

The load is measured according to the predetermined loading conditions, and the time interval is calculated according to the start and stop condition values. The start condition will start the counter once input reaches the set value of the selected start condition. The timer will be stopped once the input meets the set value of the selected stop condition.

To setup a time test:

Step 1. Enter **Time Test** mode by pressing **Mode** > **F6** > **F1**.

Step 2. Select the desired operation mode by pressing the corresponding softkey.

- Set operation mode level.

Step 3. Select a start condition. (Voltage, Current, Trigger)

- Set the start condition level.
- Set the end edge.(Rise or Fall)

Step 4. Select the stop condition. (Voltage, Current, Trigger)

- Set the stop condition level.
- Set the end edge.(Rise or Fall)

Step 5. Verify the proper ranges required for your test are selected.

4.7 Over-Current Protection Test (OCPT)

The 8550 series provides the over-current protection test function. The principle is shown in **figure 4.16**.

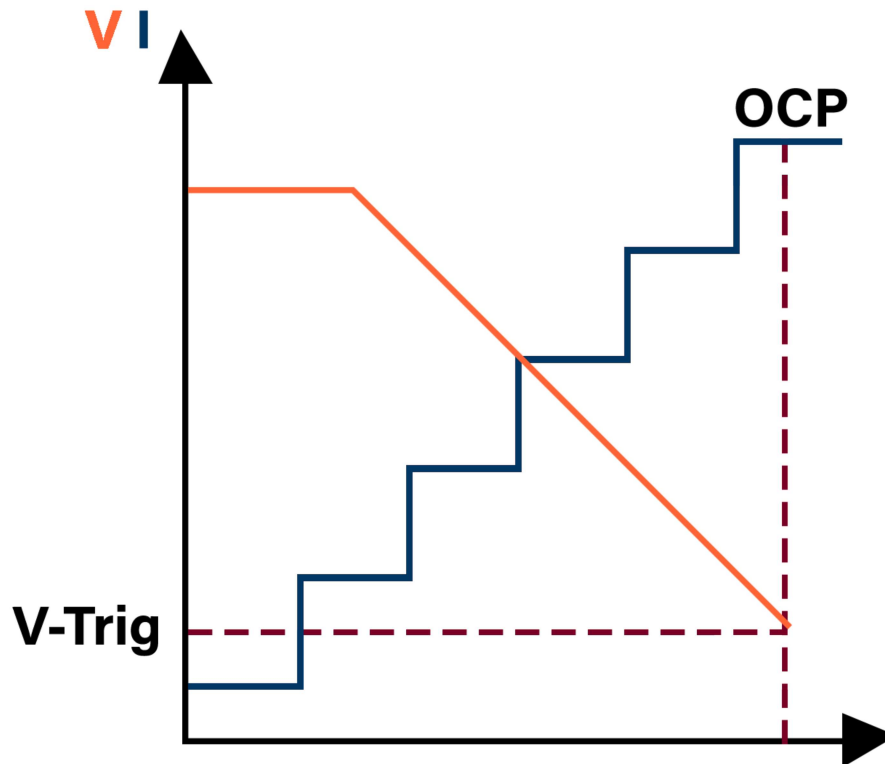

Figure 4.16 OCPT Operation

The load starts from the initial current (**I-Start**) and gradually increases the current to the cut-off current (**I-End**) according to the set number of steps (**Steps**). When it detects that the input level drops to the trigger level (**V-Trig**), it is considered that the source under test has achieved OCP protection.

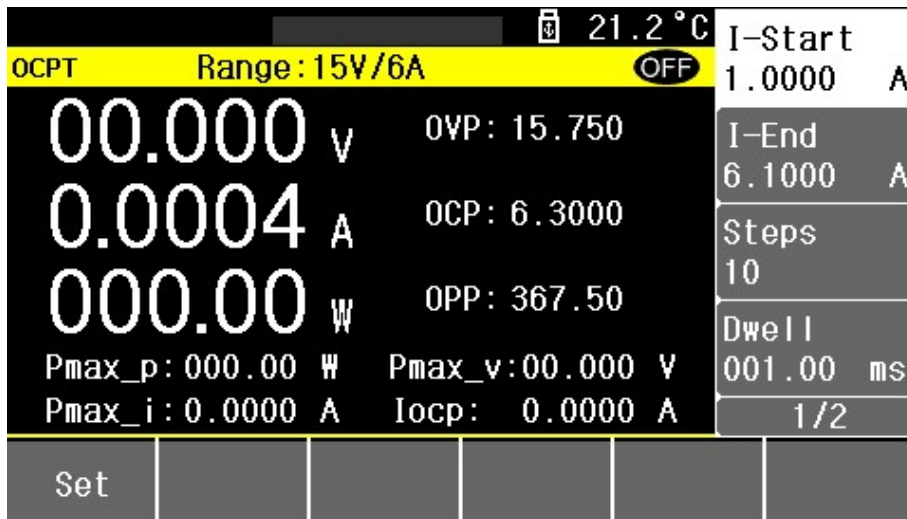

Figure 4.17 OCPT Mode

As show in **figure 4.17**, during this process, the load not only detects the OCP protection point, but also captures the power of the maximum power point, Voltage and current values.

Parameters	Description
I-Start	Sets a start current level. The load will sink this current when the test is initiated.
I-End	Sets a stop current level. When the specified current is reached, the test will end.
Steps	Set the total number of increasing steps. (1 to 1000)
Dwell	Sets the dwell time of each step.
V-Trig	Sets the voltage level that triggers over-current protection.
Latch	Sets the status of the load once the test is complete. ON: Continue to load after the test is completed. OFF: Disable load after the test is completed.

Table 4.3 OCPT Test Parameters

4.8 Over-Voltage Protection Test (OVPT)

The 8550 series provides the over-voltage protection test function. The principle is shown in **figure 4.18**.

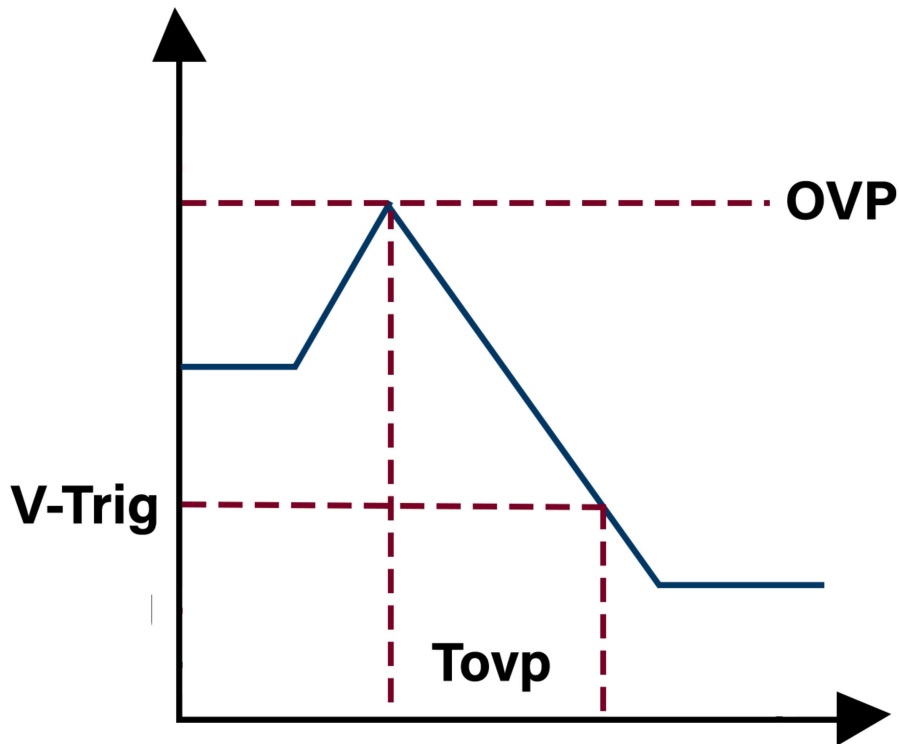

Figure 4.18 OVPT Operation

The load captures the peak point and the falling edge of the input voltage. Once the falling edge reaches the set **V-Trig** value the timer is stopped and the response time is saved as **Tovp**.

OVPT can be used to test the time required for the output of the DUT to settle from the output peak to the desired voltage.

Parameter	Description
OVP (V)	The load's over-voltage protection value set in System > Protection . Triggers the start of the counter.
V-trig (V)	Sets the voltage level at which the timer is stopped.
Tovp (ms)	Calculated time for the output to settle from the peak voltage to desired voltage value .

Table 4.4 OVPT Parameters

4.9 Over-Power Protection Test (OPPT)

The 8550 series provides the over-power protection test function. The principle is shown in **figure 4.19**.

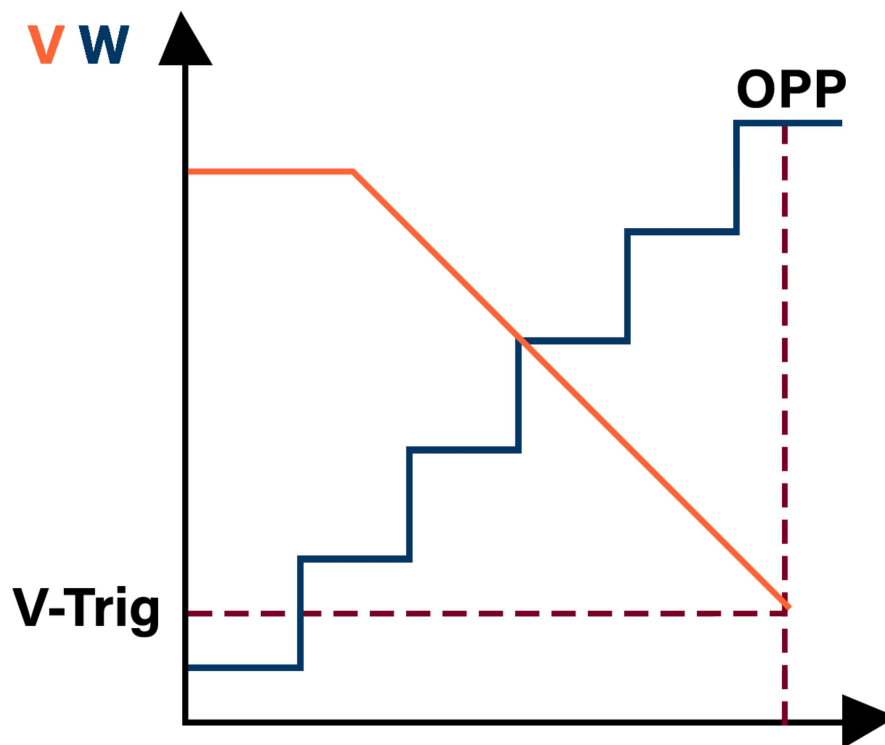

Figure 4.19 OPPT Operation

The load starts from the initial power (**P-Start**) and gradually increases the power to the cut-off power (**P-End**) according to the set number of steps (**Steps**). When the load detects that the input level drops to the trigger level (**V-Trig**), it is considered that the source under test has achieved OPP protection. During this process, the load not only detects the OPP protection point, but also captures: Pmax_power, Pmax_voltage and Pmax_current values.

Parameters	Description
P-Start	The value the load will sink this power when the test is initiated.
P-End	When the specified power is reached, the test will end.
Steps	Set the total number of increasing steps. (1 to 1000)
Dwell	Sets the dwell time of each step.
V-Trig	Sets the voltage level that triggers over-voltage protection.

Table 4.5 OPPT Test Parameters

4.10 Load Regulation Mode

The 8550 series provides the load regulation function. During the test, the load will be loaded under 3 different load currents, the minimum current (**I-Min**), the normal current (**I-Normal**) and the maximum current (**I-Max**).

Each load value will be tested for a preset time (Delay). The voltage value under different loads is recorded, and finally the negative ΔV , load regulation (Regulation) and power supply internal resistance (Rs) is calculated according to the following enumerated formulas.

$$\Delta V = V_{max} - V_{min}$$

$$R_s = \frac{\Delta V}{I_{max} - I_{min}}$$

$$Regulation = \frac{\Delta V}{V_{normal}}$$

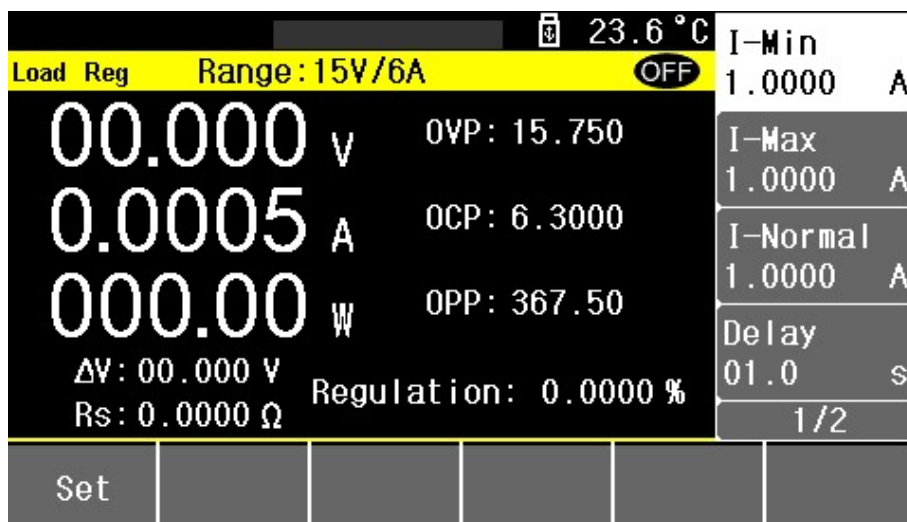

Figure 4.20 Load Regulation Menu

Parameters	Description
I-Min	Sets the low level load current.
I-Max	Sets the high level load current.
I-Normal	Set the normal working current.
Delay	Sets the dwell time of each load current.

Table 4.6 OPPT Test Parameters

4.11 Sweep Mode

Sweep mode can be used to capture the V_{p+} and V_{p-} of the power supply when tested for worst case scenario. The load is switched repeatedly between two current loads according to the preset current slope. The duration of each current level will be determined by the scan frequency and duty ratio (Duty).

The sweep frequency will gradually increase or decrease from the start frequency (**Fstart**). The frequency will change according to the number of step frequency (**Fstep**) set, until the cutoff frequency (**Fend**) is reached. The duration of each frequency step is preset by the (**Dwell**) time.

During the scanning process, the input voltage will be accompanied by the transient of the current, resulting in overshoot and drop. The load will display the maximum value (**Vp+**), the minimum value (**Vp-**), and the frequency of occurrence of the overshoot in real time.

Parameters	Description
I-Min	Sets the high current value to sink.
I-Max	Sets the low current value to sink.
Slew Rise	Sets the time required to decrease current from one specified value to the next.
Slew Fall	Sets the time required to increase current from one specified value to the next.
Fstart	Sets the frequency value at which the sweep begins.
Fend	Sets the frequency value at which the sweep ends.
Dwell	Sets the dwell time of each frequency step.
Duty	Sets the ratio of the high current to the total time.

Table 4.7 Sweep Parameters

4.12 Automatic Test Mode

The automatic test function is used to inspection the production line. The loaded runs a sequence according to the steps edited in the selected file. The pass or fail is automatically determined based on the preset condition values.

The load supports up to 10 files, each file supports up to 50 steps of testing, and each step can set the loading conditions and limit judgment.

To configure an automatic test:

Step 1. Press **Mode** > **F6** > **F6** > **F2** to enter **Auto** mode.

Step 2. Set the main parameters of the automatic test.

- Select the desired list (1-10).
- Set the count number. Number of times the file will run before the step is elapses.
- Set the trigger mode.

Step 3. Once the main parameters are set configure the file steps by pressing the **Edit** softkey (F1 when File is selected).

Step 4. Select the step to be edited, then press the **Data** softkey (F2).

Step 5. In each step the first parameter to be edited should be the mode.

No.	Mode	Data
01	CC	Value: 1.0000A Fail: Contin Limit: 0.0000-6.1000A 01.0s
02	CV	Value: 02.000V Fail: Contin Limit: 0.0000-6.1000A 01.0s
03	CR	Value: 100.00Ω Fail: Contin Limit: 0.0000-6.1000A 01.0s
04	CP	Value: 001.00W Fail: Contin Limit: 0.0000-6.1000A 01.0s

File 10
Count 002
Trig Mode Disable
1/1

Mode Data Cond Back

Figure 4.21 Edit List

- CC, CV, CR, and CW are available.
- Upon selecting the mode, **Data** and **Condition** can be set.

- The parameters for each mode varies. Please review the section corresponding to each mode for more information.

Step 6. Configure the test conditions.

- Set the **Limit** type.
- Set the limit values **Upper** and **Lower** limit.
- Set the **Fail Operation** action.(Abort the test or continue)
- Set the **Delay** type.
 - If delay type was set to time set the delay time.

Step 7. After configuring all settings, press the **ON** key to start the automatic test.

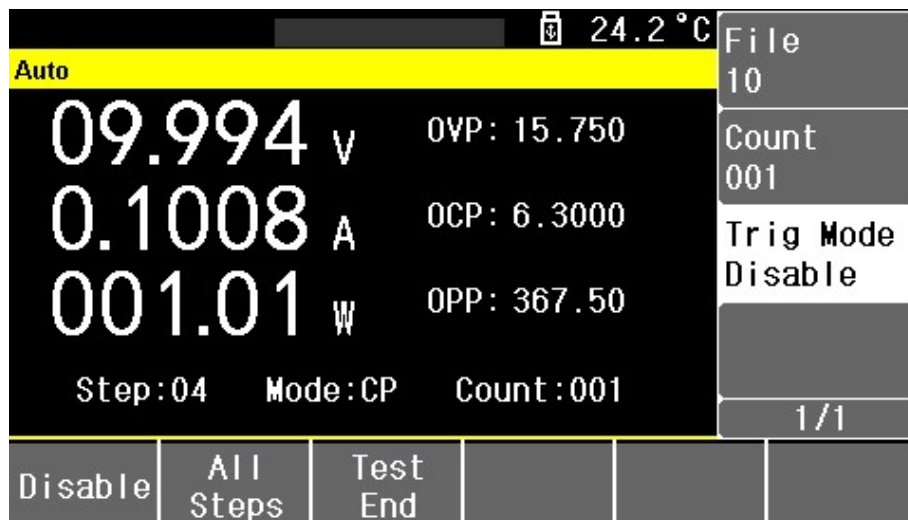

Figure 4.22 Auto Test Run

NOTICE

While the sequence is running the Step will be currently running along with the mode of that state will be displayed. Upon completion of the sequence, the number of the failed steps will be displayed.

System

The following instrument's parameters can be configured from the system menu:

5.1	System Configuration	47
5.1.1	Language	47
5.1.2	Beep Sound	47
5.1.3	Sense	47
5.1.4	Power-On	47
5.1.5	Display	48
5.1.6	Source	49
5.1.7	External Programming	49
5.2	Von/Voff	49
5.3	Protect	50
5.3.1	Over-Voltage Protection	50
5.3.2	Over-Current Protection	50
5.3.3	Over-Power Protection	50
5.3.4	Delay	50
5.4	File Store	51
5.5	Communication Setup	52
5.6	Limit	53

To enter the **System** menu press the **System** key.

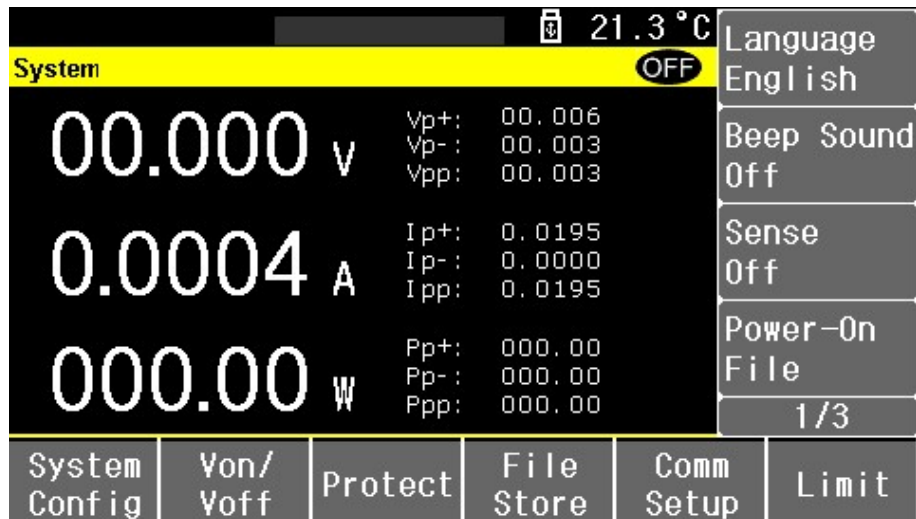

Figure 5.1 System Menu

5.1 System Configuration

All setup procedures and settings explained in this section can be accessed from the **System Configuration** menu. To access this menu, press **System > F1**.

5.1.1 Language

The 8550 series support English and Chinese. English is the default language.

5.1.2 Beep Sound

Enable/Disable the key sound.

NOTICE

Disabling the key sound does not affect the protection buzzer.

5.1.3 Sense

Enable/Disable remote sense.

Remote sense can be used to compensate for voltage drops (up to 1 V) due to resistance from test leads. The current will produce a voltage drop on the connection line. The longer the connection line, the greater the resistance of the connection line, or the greater the current, the greater the voltage drop will be. To reduce the error caused by the voltage measurement, the load provides remote compensation function, as shown below.

In addition to the [] input of the load connected to the power supply, an additional two wires are required to connect the power supply.

5.1.4 Power-On

Configures the initial Power-On state of the load between **Default** or **File**. The settings affected include all input and system settings.

Default: The factory default settings will be loaded at power on.

File: Loads the saved settings in the specified file at power on. To select the file to be loaded refer to **section 5.4**.

5.1.5 Display

During the operation of the load, the user can choose to display certain parameters or block some parameters in the data sampling display area.

U, I, P, PPon

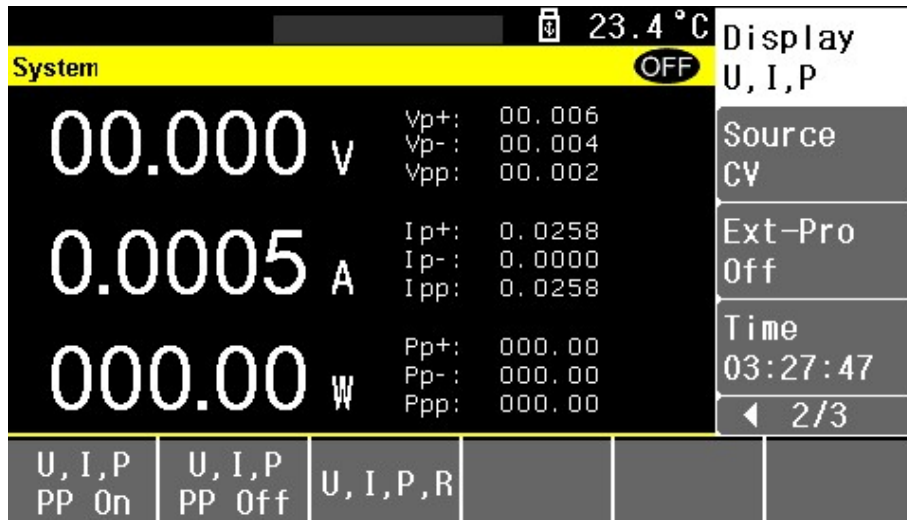

Figure 5.2 U, I, P, PPon

U, I, P, PPoff

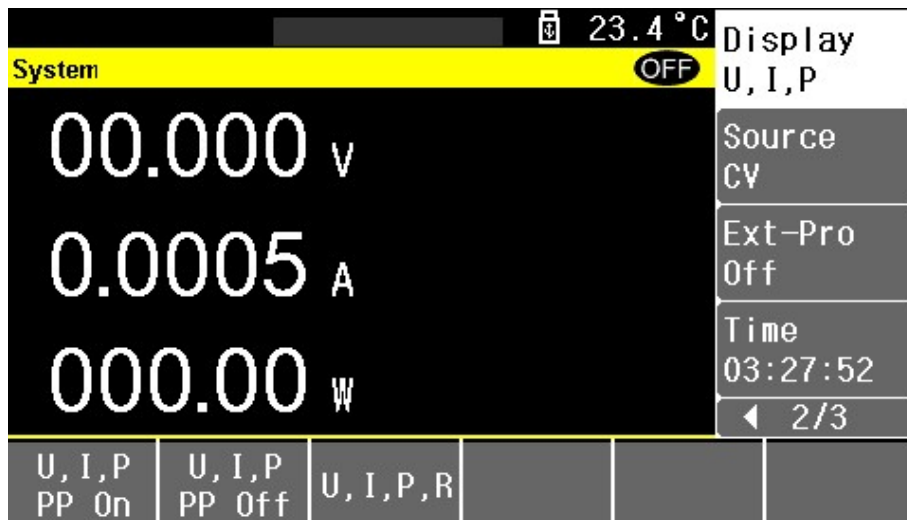

Figure 5.3 U, I, P, PPoff

U, I, P, R

Figure 5.4 U, I, P, R

5.1.6 Source

Set the output type of the DUT in advance. This is crucial for CR, CP and other modes.

CC: The DUT is a constant current source.

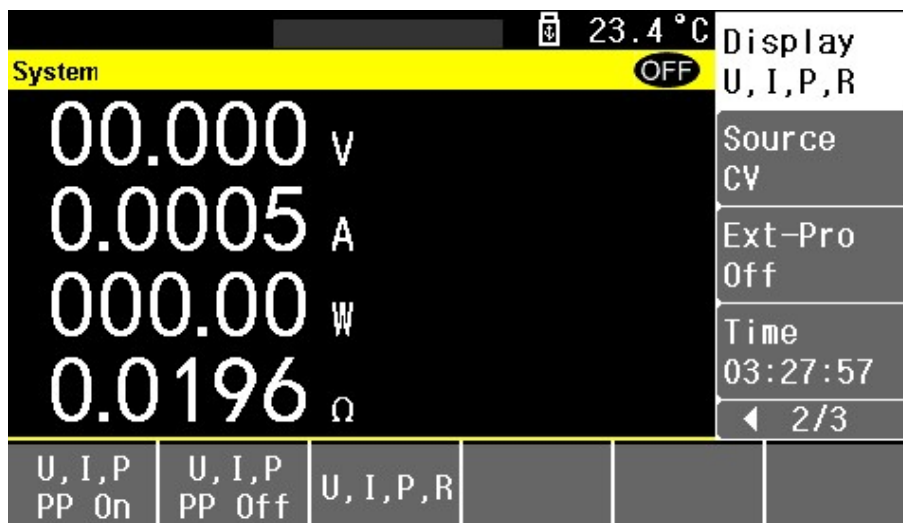
CV: The DUT is a constant voltage source.

5.1.7 External Programming

Enable/Disable the external analog programming.

Port 5 in the Handler interface on the rear panel of the instrument is the EXT-PROG port, which is used for external analog input. Connect this port to 0-10V voltage to simulate the input from 0 to full scale, thus adjust the input voltage and current value of the load. For more information about the handler refer to [section 6](#).

5.2 Von/Voff

The Von/Voff setting configures the CC mode pull-down and unload voltage.

Pull Voltage: Upon enabling the input if the input voltage is lower than this value, the ON/OFF button light flashes and no current is sunk until the input voltage exceeds this value. When the input voltage is greater than this value, the ON/OFF button light is always on and the load begins to sink current.

Unloading Voltage: When the load is officially loaded, if the input voltage value is lower than this value, the instrument is turned off and the load stops sinking current.

5.3 Protect

The electronic load has the following protection functions: Overvoltage protection (OVP), overcurrent protection (OCP), and overpower protection (OPP).

The instrument will act appropriately once any of the above protections are active. You can press the enter button on the front panel to restore the protection function. For example, if the electronic load triggers the overvoltage protection, the buzzer will alarm, the input will automatically turn off, and a notification indicating over volt will be displayed.

Each protection value can be set to default or user.

Default value : As the range is switched, the protection value is automatically adjusted to 1.05 times the current range value.

User value : According to user needs, the value can be set not to exceed the maximum range

5.3.1 Over-Voltage Protection

Sets a voltage protection value. The value can be set from 0 up to 105% of the maximum voltage range. When OVP is triggered the input will be disabled, the buzzer will notify the user, and function of the instrument will not be available until the user presses the **Enter** key.

5.3.2 Over-Current Protection

Sets a current protection value. The value can be set from 0 up to 105% of the maximum current range. When OCP is triggered the input will be disabled, the buzzer will notify the user, and function of the instrument will not be available until the user presses the **Enter** key.

5.3.3 Over-Power Protection

Sets a power protection value. The value can be set from 0 up to 105% of the maximum power range. When OPP is triggered the input will be disabled, the buzzer will notify the user, and function of the instrument will not be available until the user presses the **Enter** key.

5.3.4 Delay

Sets the delay time between the load triggering protection and the input being disabled. This helps prevent accidental pulses from triggering the load protection. If the load protection is still triggered after the delay time expires, the load is stopped.

5.4 File Store

The instrument can save the current parameter settings and configuration of the load in flash. To save the current parameters:

Step 1. Press **System** > **F4** to enter the **File Store** menu.

Step 2. Select in what memory the file will be saved. Internal File (**F1**) or External File (**F2**)

Step 3. Press the **F6** softkey to enter edit mode.

Step 4. In edit mode select the File number to be modified.

- If the selected file has no data saved, press **F1** to save the current parameters to the specified file. (A file name will have to be assigned using the number pad.)
- If the selected file already has data saved the file can be assigned as the load file, if it is already the load file it can be removed as the load file. The file can also be copied to another file number or deleted.

Step 5. The selected load file will have a checkmark to the right of the file name.

File			File
No.	I: /		Inter
01	R.STA ✓	00-10-30	
02			
03			
04			
05			
06			1/1

23.4 °C

OFF

Inter File Exter File Edit

Figure 5.5

NOTICE

Power-On must be set to user to load the selected file at power on.

5.5 Communication Setup

The 8550 series supports remote communication over the RS232 interface.

The parameters of the interface can be configured in the **Communication Setup** menu. The following parameters are supported.

Baud rate : 4800, 9600, 19200, 38400, 115200

Data bits : 5, 6, 7, 8

Stop bits : 1, 2

Parity : No parity, odd parity, even parity, flag, space

Refer to **image 5.6** for the RS232 pinout. The RS-232 is labeled in the rear panel and it is a female DB-9 interface.

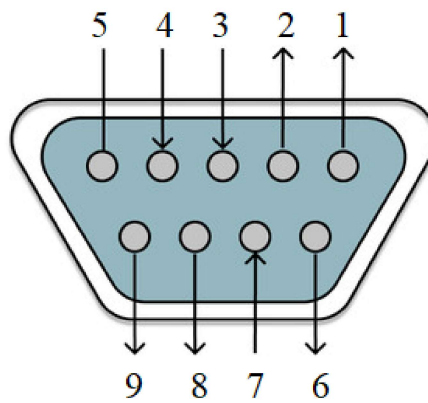

Figure 5.6 RS232 Pinout

Pin	Description
2	Transmits Data
3	Receives Data
5	GND

Table 5.1

NOTICE

A straight pin-to-pin DB9 female to DB9 male serial cable is required for using the RS-232 interface. Do not use a null modem or crossover DB9 serial cable.

5.6 Limit

Sets the pass and fail parameters for the voltage, current, and power input.

Each parameter consist of 3 parts; Trigger state, lower value, and upper value. The trigger state determines if the instrument reports a fail input.

If trigger status is set to On the buzzer will inform the user whenever the input fails to meet the specified lower or upper value.

If the trigger is set to off there will not be any notification of a failing input signal.

NOTICE

The instrument will continue the selected function even if the input signal triggers the fail status.

Handler

The 8500 series provides a **HANDLER** interface. The handler can be used to receive external trigger signals, control signals, and output a signal for sorting results.

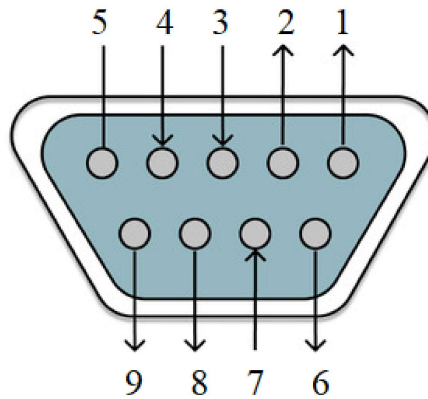

Figure 6.1 Handler Pinout

Pin	Function	Description
1	DGND	Digital ground(chassis ground)
2	ON	External ON/OFF control signal, low pulse is effective
3	TRIG	External trigger signal, low pulse is effective
4	AGND	Analog ground
5	VF/EXT-PROG	Refer to section 6.3
6	PASS2	Success signal
7	PASS1	Success signal
8	FAIL2	Failure signal
9	FAIL1	Failure signal

Table 6.1

6.1 ON Function

This interface function is equivalent to the front panel ON/OFF key, and the low pulse signal is effective. When a low pulse signal is received, the load sinks current and the ON/OFF button LED lights up. When the low pulse signal is received again, the load stops sinking current and the ON/OFF button LED is disabled.

6.2 TRIG

The trigger function is equivalent to the TRIG key on the front panel, and the low pulse signal is effective.

6.3 VF/EXT-PROG

VF

Reverse polarity indication signal. When the polarity of the load input terminal is reversed, this port outputs

EXT-PROG

External analog input, simulates the input from 0 to full scale by connecting the 0-10V voltage to this port to adjust the input voltage and current value of the load.

NOTICE

EXT-PROG in the **System Config** menu must be enabled.

6.4 Pass/Fail

During the automatic test, the corresponding Pass or Fail signal is output according to the load test result.

Specifications

Note: All specifications apply to the unit after a temperature stabilization time of 30 minutes over an ambient temperature range of 23 °C ± 5 °C.

Model		8550	8551
Input Ratings			
Input voltage		0 to 150 V	0 to 150 V
Input current	Low	0 to 3 A	0 to 6 A
	High	0 to 30 A	0 to 60 A
Input power		175 W	350 W
Minimum operating voltage	Low	0.15 V at 3 A	0.15 V at 6 A
	High	1.5 V at 30 A	1.5 V at 60 A
CV Mode			
Range	Low	0 to 15 V	
	High	0 to 150 V	
Resolution	Low	0.2 mV	
	High	2 mV	
Accuracy		±(0.05% + 0.05% FS)	
CC Mode			
Range	Low	0 to 3 A	0 to 6 A
	High	0 to 30 A	0 to 60 A
Resolution	Low	0.05 mA	0.1 mA
	High	0.5 mA	1 mA
Accuracy		±(0.05% + 0.05% FS)	
CR Mode			
Range		0.05 Ω to 30 kΩ	0.03 Ω to 20 kΩ
Resolution		0.1 Ω	
Accuracy		1%	
CW Mode			
Range		0 to 175 W	0 to 350 W
Resolution		10 mW	
Accuracy		±(0.5% + 0.1% FS)	
Transient Mode (CC mode)			
T1 & T2 ⁽¹⁾		100 μs to 60 s	
Resolution		2 μs	
Accuracy		1 μs + 100 ppm	
Slew Rate ⁽²⁾		0.6 A/ms to 1.5 A/μs	1.2 A/ms to 3 A/μs

Readback Voltage			
Range	Low	0 to 15 V	
	High	0 to 150 V	
Resolution	Low	1 mV	
	High	10 mV	
Accuracy		±(0.08% + 0.05% FS)	
Readback Current			
Range	Low	0 to 3 A	0 to 6 A
	High	0 to 30 A	0 to 60 A
Resolution	Low	0.1 mA	
	High	1 mA	
Accuracy		±(0.08% + 0.05% FS)	
Readback Ripple ⁽³⁾			
Range	Low	0 to 15 V	
	High	0 to 150 V	
Bandwidth		250 kHz	
Accuracy		0.1%	
General			
Protection		Over voltage protection (OVP), Over current protection (OCP), Over power protection (OPP), and Remote reverse voltage (RRV)	
I/O Interfaces		RS232 and Handler	
AC Input		110 V/220 V ±10%, 50 Hz/60 Hz ±5%	
Maximum Rated Input Power		< 50 VA	
Temperature		32 °F to 104 °F (0 °C to 40 °C)	
Humidity		Indoor use, < 90% RH	
Safety		EN 61010-2010+A1:2019, Low Voltage Directive (LVD) 2014/35/EU	
Electromagnetic Compatibility		EN61326-1:2021, CISPR 11, EN61000-3-2:2019+A1:2021, EN61000-3-3:2013+A1:2019+A2:2021, EMC Directive 2014/30/EU	
Dimensions (W x H x D)		8.4" x 3.5" x 15.4" (213 x 88 x 390 mm)	
Weight		6.61 lb (3 kg)	10.58 lb (4.8 kg)
Warranty		3 Years	
Standard accessories		Power cord and certificate of calibration	
Optional accessories		TLPWRI high current test leads	

Service Information

Warranty Service: Please go to the support and service section on our website at bkprecision.com to obtain an RMA #. Return the product in the original packaging with proof of purchase to the address below. Clearly state on the RMA the performance problem and return any leads, probes, connectors and accessories that you are using with the device.

Non-Warranty Service: Please go to the support and service section on our website at bkprecision.com to obtain an RMA #. Return the product in the original packaging to the address below. Clearly state on the RMA the performance problem and return any leads, probes, connectors and accessories that you are using with the device. Customers not on an open account must include payment in the form of a money order or credit card. For the most current repair charges please refer to the service and support section on our website.

Return all merchandise to B&K Precision Corp. with prepaid shipping. The flat-rate repair charge for Non-Warranty Service does not include return shipping. Return shipping to locations in North America is included for Warranty Service. For overnight shipments and non-North American shipping fees please contact B&K Precision Corp.

Include with the returned instrument your complete return shipping address, contact name, phone number and description of problem.

B&K Precision Corp.
22820 Savi Ranch Parkway
Yorba Linda, CA 92887
bkprecision.com
714-921-9095

LIMITED THREE-YEAR WARRANTY

B&K Precision Corp. warrants to the original purchaser that its products and the component parts thereof, will be free from defects in workmanship and materials for a period of **three years** from date of purchase. B&K Precision Corp. will, without charge, repair or replace, at its option, defective product or component parts. Returned product must be accompanied by proof of the purchase date in the form of a sales receipt.

To help us better serve you, please complete the warranty registration for your new instrument via our website www.bkprecision.com

Exclusions: This warranty does not apply in the event of misuse or abuse of the product or as a result of unauthorized alterations or repairs. The warranty is void if the serial number is altered, defaced or removed.

B&K Precision Corp. shall not be liable for any consequential damages, including without limitation damages resulting from loss of use. Some states do not allow limitations of incidental or consequential damages. So the above limitation or exclusion may not apply to you.

This warranty gives you specific rights and you may have other rights, which vary from state-to-state.

B&K Precision Corp.
22820 Savi Ranch Parkway
Yorba Linda, CA 92887
www.bkprecision.com
714-921-9095

Version: May 23, 2023