

ELMO

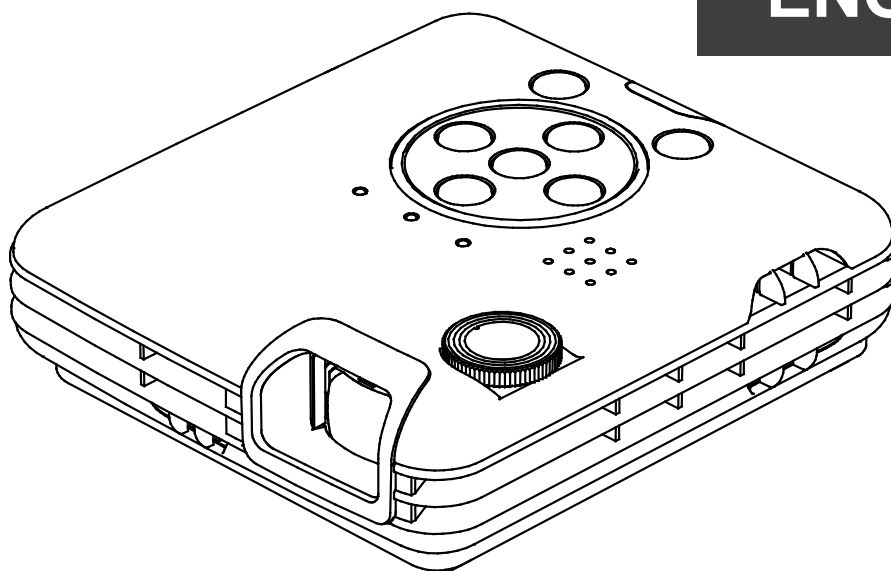
BOXi

MP-350

MOBILE PROJECTOR

QUICK START GUIDE

ENGLISH



- Read this guide and the separate “IMPORTANT SAFEGUARD” carefully before using the projector.
- This guide describes the basic operation of the projector taking for example of the connection to a computer. Refer to the instruction manual of the BOXi for any other operations and detailed information.

《BOXi Instruction manual》

Download the instruction manual from the following BOXi website.

BOXi Product Website : <http://boxi.elmoglobal.com/>

©2012 Copyright ELMO Co., Ltd. All rights reserved.

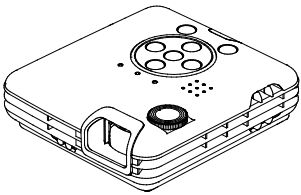
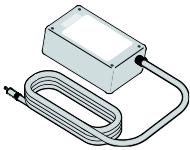
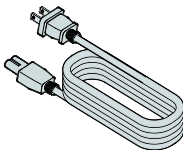
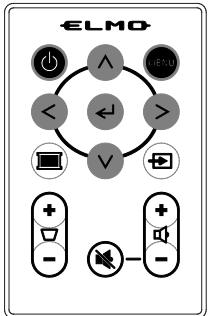
Any names, company names and product names referred to in this guide are trademarks or registered trademarks of the respective companies.

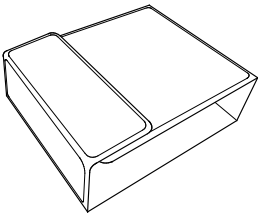



TABLE OF CONTENTS

TABLE OF CONTENTS	2
1 GETTING STARTED.....	3
Checking the package contents	3
Part names and functions.....	4
Preparing the remote control.....	5
2 USING THE PROJECTOR.....	6
Installing the projector	6
Connecting to a device.....	7
Powering on	8
Detecting the input signal	9
Adjusting the projected image	10
Powering off	11

1 GETTING STARTED

Checking the package contents

Projector	AC adapter	Power cord	Remote control
			 *Battery included

Protective cover	IMPORTANT SAFEGUARD	WARRANTY CARD	CD-ROM
 *with Hook and loop fastener (2pcs)			 *QUICK START GUIDE included



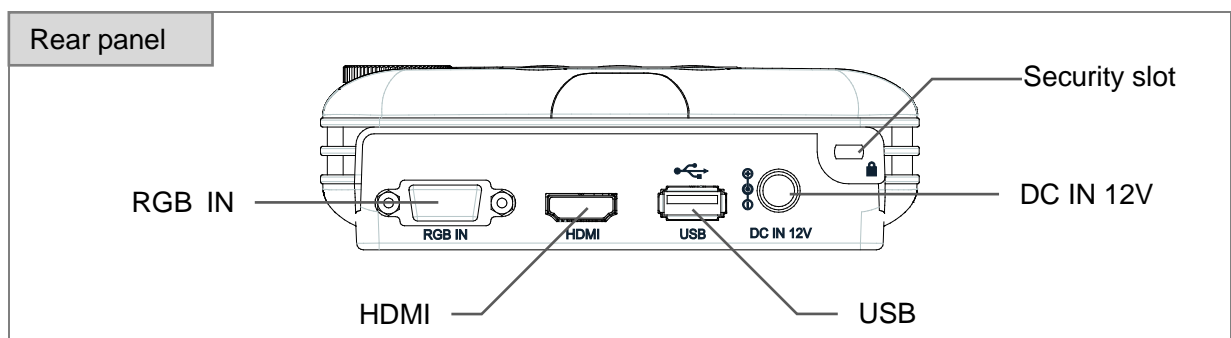
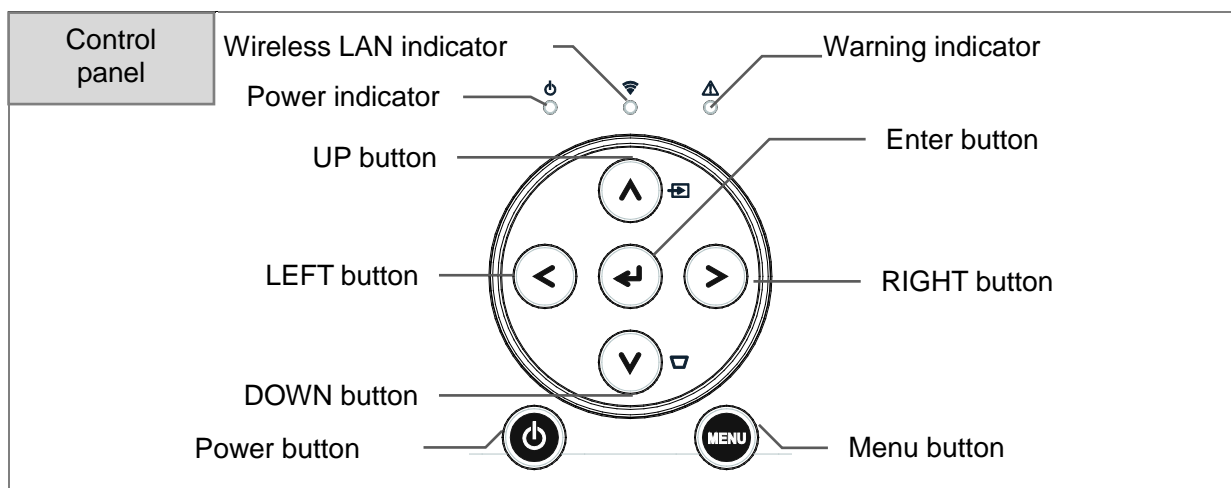
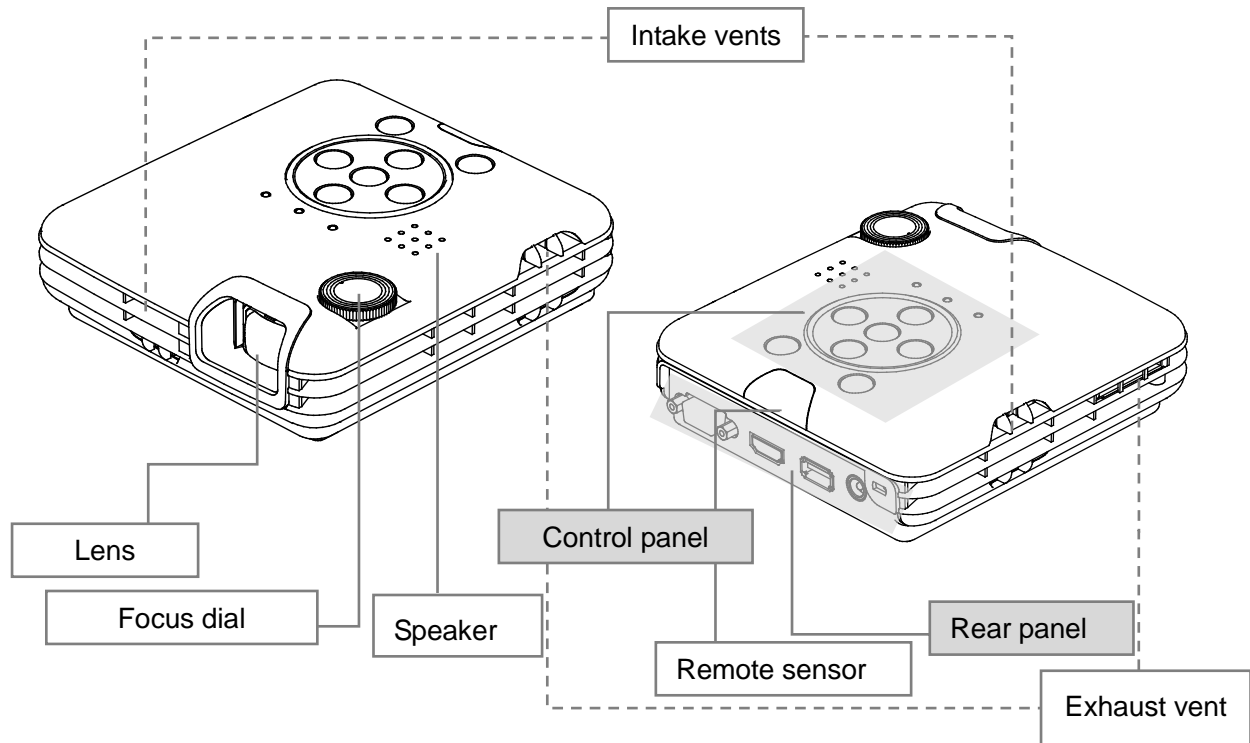
Note

- Refer to the instruction manual of the BOXi for details how to use the Protective cover.

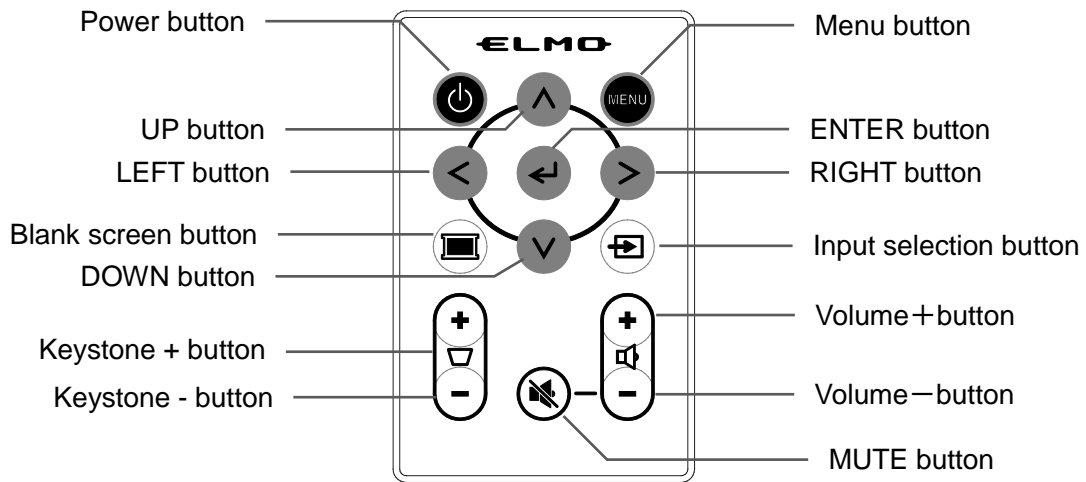
Part names and functions

TOP/FRONT

TOP/BACK

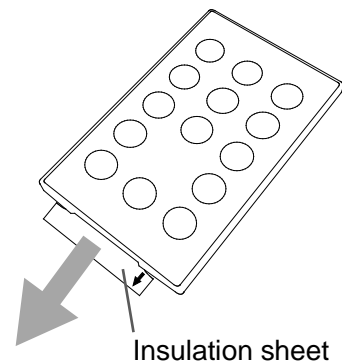


Remote control



Preparing the remote control

A battery is pre-installed in the remote control at the time of shipment (with insulation sheet). Remove the insulation sheet before using the remote control for the first time.

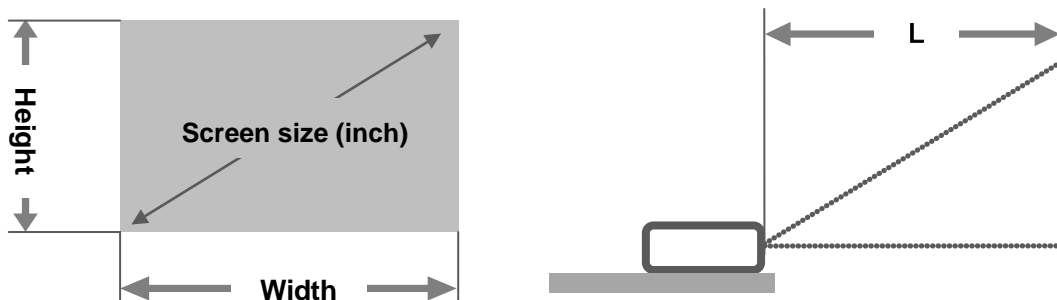


2 USING THE PROJECTOR

Installing the projector

Decide the position to place the projector.

The distance between the projector and the screen should be between 48cm (screen size: 25 inch) and 133cm (screen size: 68 inch).



Screen size			Projection distance L(cm)
Inch	Width (cm)	Height (cm)	
25	53.8	33.7	48
30	64.6	40.4	58
35	75.4	48.0	68
40	86.1	53.8	78
45	96.9	60.6	88
50	107.7	67.3	98
55	118.5	74.0	108
60	129.2	80.8	118
65	140.0	87.5	128
68	146.5	91.5	133



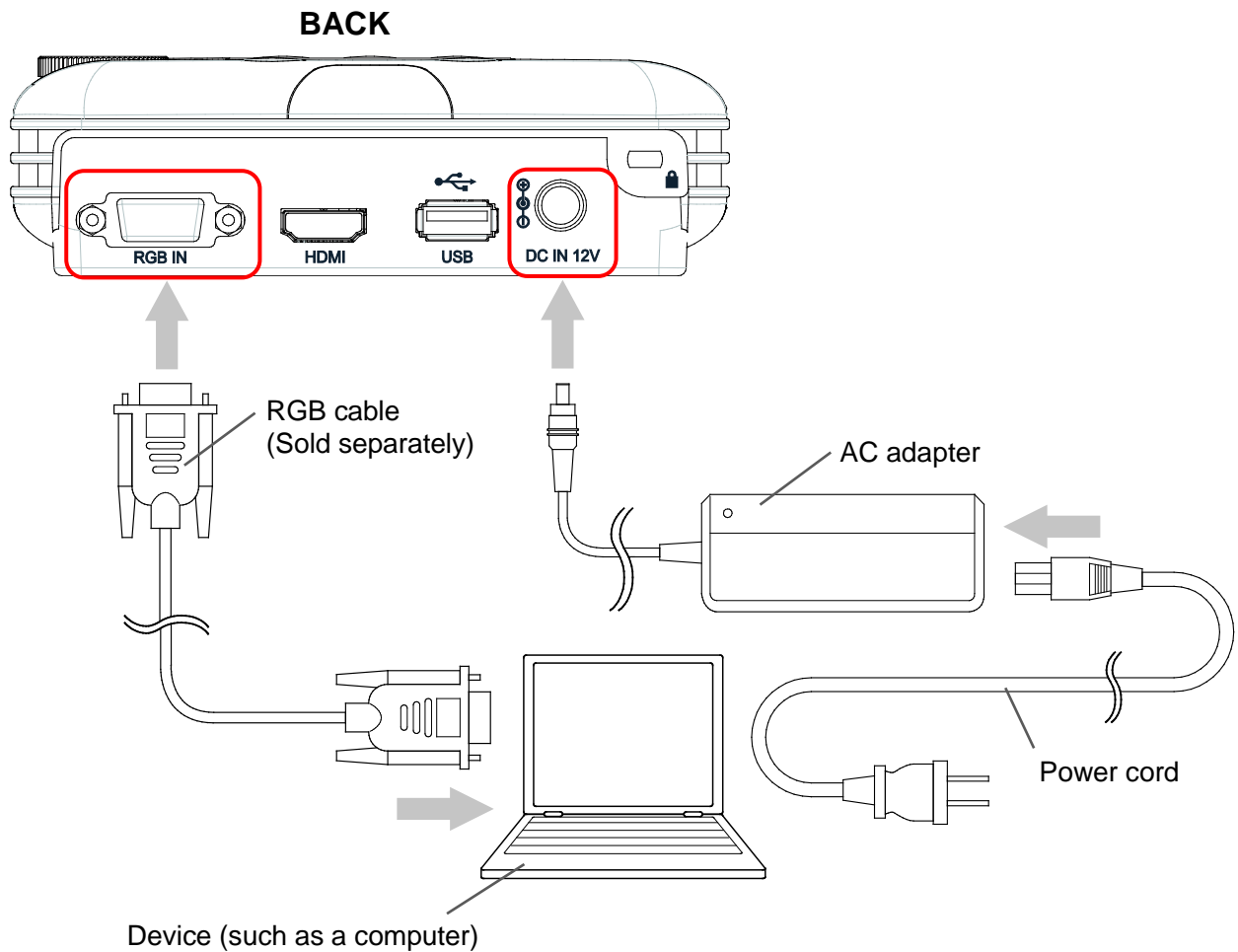
Note

- The values in the table are design values and may vary. Use them as an indication only.
- The aspect ratio of the projected image in full screen is 16:10. When the aspect ratio of the input signal is different from 16:10 (such as 16:9 or 4:3), top and bottom or left and right of the image will not be displayed and the screen size becomes smaller than those specified in the above table.

→ Refer to the instruction manual of the BOXi for detailed information.

Connecting to a device -Connecting using RGB terminal

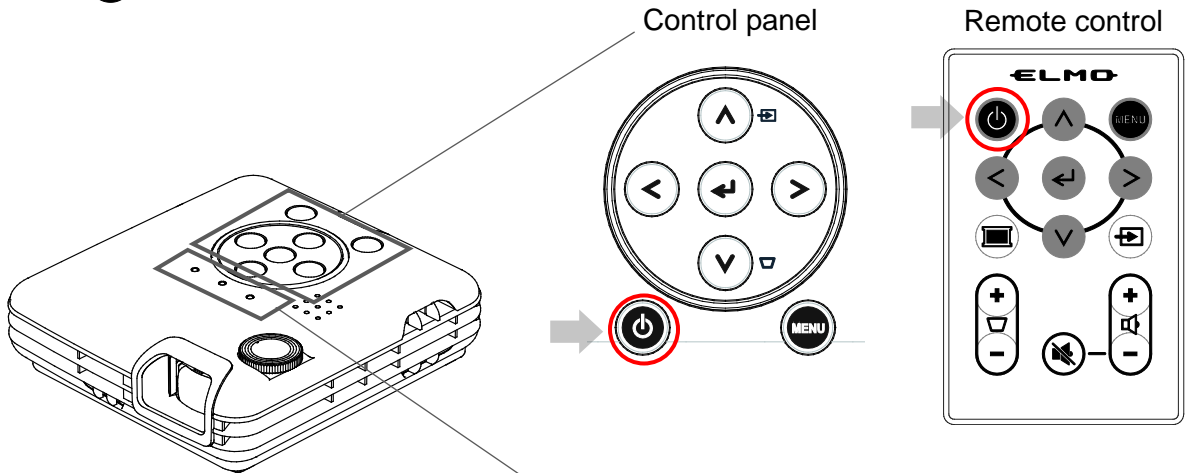
1. Connect the power supply (AC adapter and power cord) to the projector.
2. Connect the projector to the device such as a computer using RGB cable.



When using HDMI, use the HDMI terminal and HDMI cable (sold separately).

Powering on

1. Press  button on the projector or the remote control.



Power indicator  turns green.

(Wireless LAN indicator  turns on at the same time.)



The opening screen appears.



Note

- It will take some time before you can operate the projector after the power is on.
- Refer to the instruction manual of the BOXi for details about the wireless LAN indicator and functions of the wireless LAN.

Detecting the input signal

Wait until the projector automatically detects the input signal

AUTO function to automatically detect the input signal is enabled at the time of shipment. When the device is connected using RGB terminal or HDMI terminal, the input signal is detected automatically.



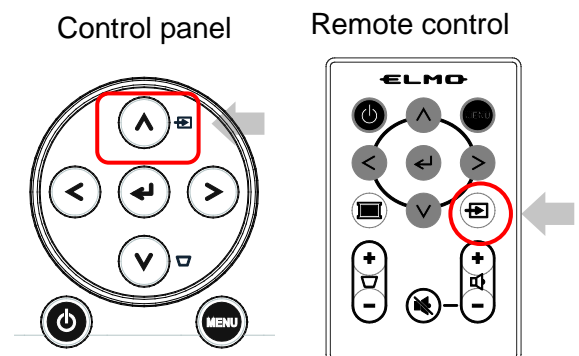
Note

- Take the following steps to select the input signal manually.

Selecting the input signal from the menu

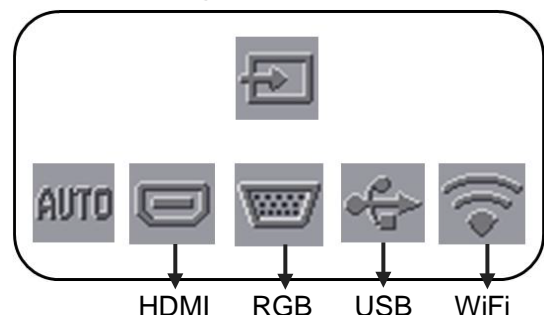
- Press button on the remote control or button on the control panel.

「Input signal selection menu」 appears.



- Select the input signal using buttons.

Input signal selection menu



- Press button to execute.

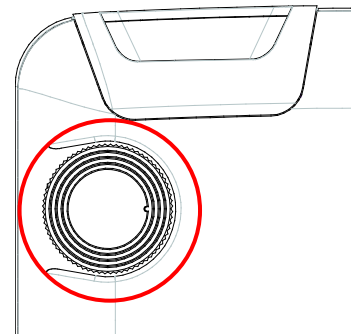
Note

- Input signal selection can only be done from the menu when USB or WiFi is selected.
- Refer to the instruction manual of the BOXi for details about the operation.


Adjusting the projected image

Focusing the image

1. Use the focus dial to focus the image.



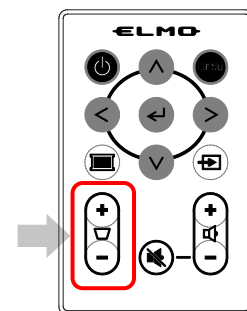
Correcting the keystone distortions

1. Press + or - of  button on the remote control.
「Keystone adjustment dialog」 appears.

Keystone adjustment dialog



Remote control

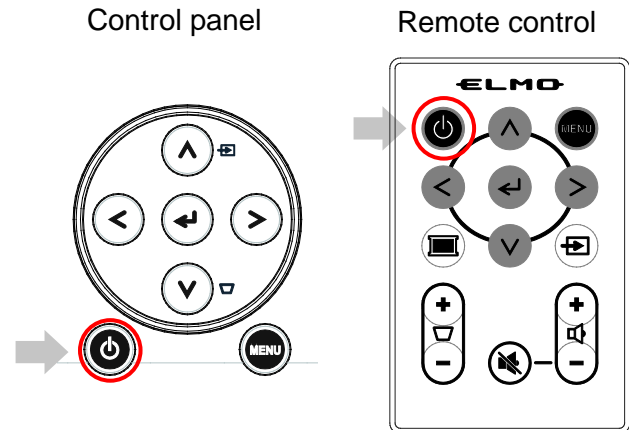


2. Press + or - of  button on the remote control.

Remote control	
Press + button (Press this button when the projection angle is increasing.)	
Press - button (Press this button when the projection angle is decreasing.)	

Powering off

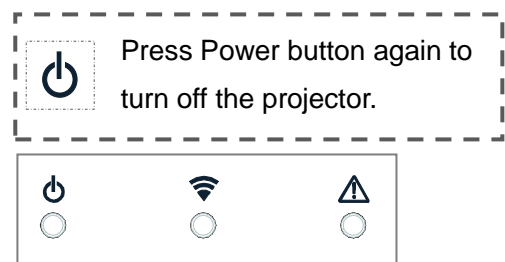
1. Press  button on the projector or the remote control.



2. The message appears. Then press  button again.

Power indicator  turns off.

(Wireless LAN indicator  turns off at the same time.)



Unplug the cable after the fan has stopped.

CAUTION

When the warning indicator is lit or flashing, it indicates that some malfunction occurred to the projector. Refer to the instruction manual of the BOXi.

ELMO CO., LTD.

6-14, Meizen-cho, Mizuho-ku
Nagoya, 467-8567, Japan

OVERSEAS SUBSIDISRY COMPANIES

ELMO USA CORP.

Headquarters
1478 Old Country Road
Plainview, NY 11803, U.S.A.
Tel. (516) 501-1400 Fax.(516) 501-0429
E-mail: elmo@elmousa.com
Web: <http://www.elmousa.com>

West Coast Branch

5676 Corporate Avenue
Cypress, CA 90630, U.S.A.
Tel. (714) 828-8457 Fax. (714) 823-8429

ELMO Europe SAS

Headquarters
Immeuble Elysées La Défense,
7C, Place du Dôme,
92056 Paris La Défense, France
Tel. 33 (0) 1 73 02 67 06
Fax. 33 (0) 1 73 02 67 10

German Branch

Hansaallee 201, Haus 1
40549 Düsseldorf Germany
Tel. 49 (0) 211 544756 40
Fax. 49 (0) 211 544756 60