

BT3554

BT3554-10

BT3554-01

BT3554-11

HIOKI

Instruction Manual

BATTERY TESTER



EN

Oct. 2018 Revised edition 3
BT3554A961-03 18-10H



Battery Tester Quick Guide

Let's Start by Measuring a New Battery

To determine if a battery is worn out, measure the data of a new battery. As a battery wears out, its internal resistance increases to **approximately 1.5 to 2 times** (reference value) that of a new one. Use these values as guidelines when determining the battery wear judgment values.

Example: Changes in the internal resistance and voltage due to battery wear

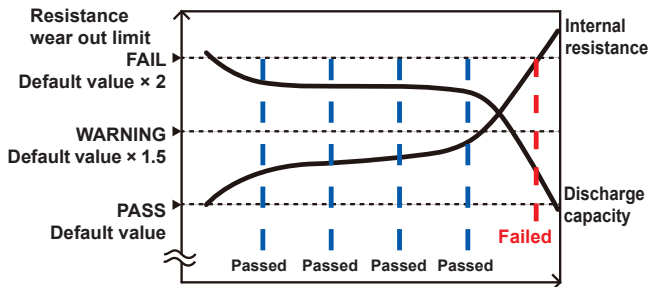
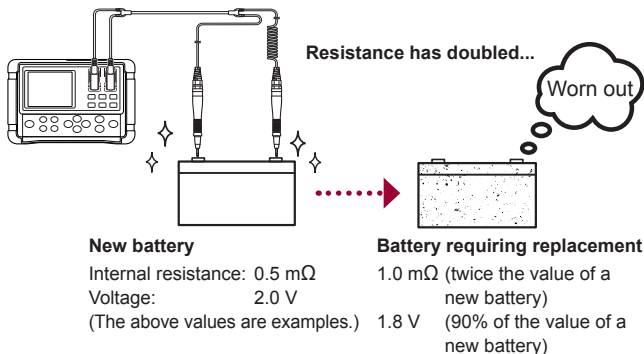

Basic Usage

1 Connect the test leads to the instrument.

2 Turn the instrument power on.

Check the clock settings when using the instrument for the first time. (p. 36)

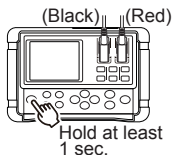

3 Changing the ranges. (p. 39)



4 Turn on the auto-hold function and auto-memory function.

(**A.HOLD** and **A.MEMO** are displayed.)



Auto-hold function: Holds measurement values automatically when they become stable. (p. 75)

Auto-memory function: Automatically stores measurement values immediately after they are held. (p. 76)

5 Connect the test leads to the battery.

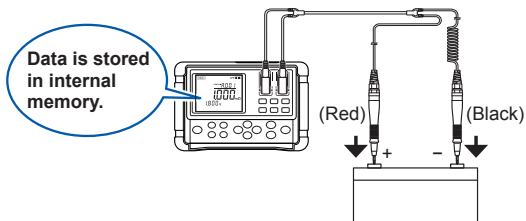

6 Press the **READ** key to read out the measurement values. (p. 69)

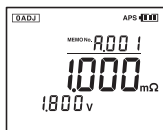

Handy Features

● Comparator function

With the comparator function, the threshold values can be set to determine if the battery is worn out. (p. 55)

Setting examples of the battery wear judgment values

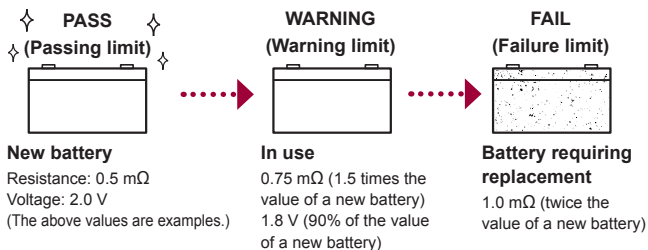

● Downloading measurement values to a computer

By connecting the instrument to a computer with the included USB cable, the measurement data can be downloaded to the computer. (p. 83)



● Viewing measurement values on a mobile device (only for BT3554-01)

With the Bluetooth® Communication function, the measurement data can be viewed on a smart phone or tablet. (p. 84)



Contents

Introduction.....	1
Verifying Package Contents	2
Options	4
Safety Information	7
Operating Precautions	12

1 Overview 19

1.1 Measuring Battery Wear	19
1.2 Overview	21
1.3 Features	22
1.4 Names and Functions of Parts	24
1.5 Dimensions	29

2 Measurement Preparations 31

2.1 Attaching the Neck Strap	31
2.2 Installing/Replacing Alkaline Batteries	32
2.3 Connecting the Test Lead.....	33
Connecting a Pin Type Lead and the Model	
9466 Remote Control Switch	34
2.4 Turning the Power ON/OFF	35
2.5 Clock Function	36
Turning the Date and Time Display ON/OFF	36
Adjusting the Date and Time.....	36

3 Measurement 37

3.1 Pre-operation Inspection	38
3.2 Setting the Measurement Range	39
3.3 Adjusting Zero Value	
(Zero Adjustment)	40

	Shorting Methods for Various Test Leads	41
	Performing Zero Adjustment	44
	Zero Adjustment Troubleshooting	46
	Canceling the Zero Adjustment Operation	46
3.4	Retaining the Displayed Values	47
	Canceling the Retaining State	47
	When retaining with the Model 9466 Remote Control Switch.....	48
3.5	Determining Battery-wear Judgment Values	49
3.6	Measuring a Battery (Inspection)	50
	Error Measurements	52
	Warning Display.....	52
3.7	Measuring the Temperature	53
	Changing the temperature display unit	54
4	Comparator Function (Evaluation by Threshold Values)	55
4.1	Overview	55
4.2	Turning On the Comparator Function	56
4.3	Setting Threshold Values for the Comparator	57
	Comparison Table for the Comparator.....	61
4.4	Setting the Comparator Buzzer	63
4.5	Canceling the Comparator Function	64
5	Memory Function	65
5.1	Overview	65
	Memory Structure	65
5.2	Storing Data in the Memory	66
5.3	Canceling the Memory Function.....	68
5.4	Reading Out Stored Data.....	69

5.5	Clearing Stored Data.....	70
	Clearing a Single Set of Data	70
	Clearing Data from Each Unit	71
	Clearing All Data	72

6 Other Features 73

6.1	Noise Frequency Avoidance Function	73
6.2	Auto-hold Function	75
6.3	Auto-memory Function.....	76
6.4	Auto Power Save Function (APS).....	77
6.5	Backlight	78
6.6	System Reset.....	79
	Default Settings (Factory Defaults).....	80
6.7	Battery Level Warning	81

7 Communications Function 83

7.1	Communicating with a Computer	83
7.2	Communicating with a Smart Phone or Tablet (Only for BT3554-01).....	84
	Installing the smartphone app GENNECT Cross.....	85
	Turning ON/OFF the Bluetooth® function.....	86
	Pairing the app with the battery tester (BT3554-01) .	87
	Making measurements with the Bluetooth® function.	88

8 Specifications 89

8.1	General Specifications	89
8.2	Basic Specifications	91
8.3	Accuracy Specifications.....	93
8.4	Functional Specifications.....	95
8.5	Communication Specifications.....	102

9 Maintenance and Service 103

9.1	Repair, Inspection, Cleaning	103
9.2	Troubleshooting	105
	Before Returning for Repair	105
9.3	Error Messages	107
9.4	Frequently Asked Questions	108
9.5	Replacing the Fuse	109
9.6	Replacing the Test Lead's Tip Pin	110
9.7	Disposing the Instrument (Removing the Lithium Battery)	113

Appendix Appx.1

Appx. 1	Effect of Extending the Test Lead and Induced Voltage	Appx.1
	Reducing Induced Voltage	Appx.1
Appx. 2	Effect of Eddy Currents	Appx.2
Appx. 3	AC 4-terminal Measurement Method . Appx.3	
Appx. 4	Effects of Current Density	Appx.5
	When the Measurement target is Wide or Thick	Appx.5
Appx. 5	Synchronous Detection System	Appx.7
Appx. 6	Calibration	Appx.8
	Calibrating the Resistance Measurement Component	Appx.8
	Calibrating the Voltage Measurement Unit ...	Appx.9

Introduction

Thank you for purchasing the Hioki BT3554, BT3554-01, BT3554-10, BT3554-11 Battery Tester.

To obtain maximum performance from the instrument, please read this manual first, and keep it handy for future reference.

In this document, the model is indicated as BT3554 or BT3554-01 (as printed on the instrument), shown below.

✓ : Yes, – : No

Model	Model printed on the instrument	Bluetooth®	Standard accessory: Pin Type Lead
BT3554	BT3554	–	9465-10
BT3554-01	BT3554-01	✓	9465-10
BT3554-10	BT3554	–	L2020
BT3554-11	BT3554-01	✓	L2020

Trademarks

- Bluetooth® is a registered trademark of Bluetooth SIG, Inc.(USA). The trademark is used by HIOKI E.E. CORPORATION under license.
- Android and Google Play are trademarks of Google, Inc.
- IOS is a registered trademark of Cisco Systems, Inc. and/or its affiliates in the United States and certain other countries.
- iPhone, iPad, iPad mini™, iPad Pro, and iPod touch are trademarks of Apple Inc.
- The App Store is a service mark of Apple Inc.

Verifying Package Contents

When you receive the instrument, inspect it carefully to ensure that no damage occurred during shipping. In particular, check the accessories, panel switches, and connectors. If damage is evident, or if it fails to operate according to the specifications, contact your authorized Hioki distributor or reseller.

Confirm that these contents are provided.

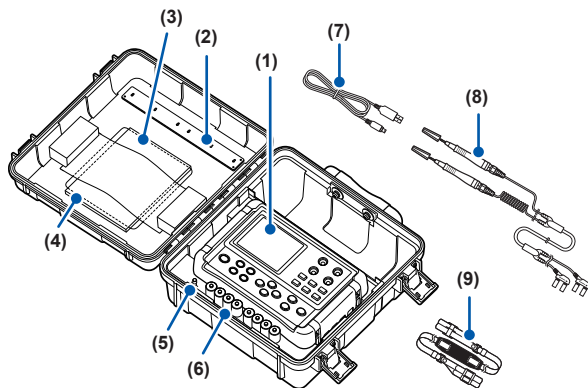

- (1) Model BT3554 or BT3554-01 Battery Tester × 1,
Protector × 1 (attached)
- (2) Zero adjustment board × 1
- (3) Instruction manual*¹ × 1, Precautions Concerning Use of Equipment That
Emits Radio Waves (only for BT3554-01) × 1,
Application software*² CD × 1, Power-on option sticker*³ × 1
- (4) Carrying Case × 1
- (5) Spare fuse × 1
- (6) LR6 (AA) alkaline batteries × 8
- (7) USB cable × 1
- (8) Model 9465-10 or L2020 Pin Type Lead × 1
- (9) Neck strap × 1

*1 Instruction manuals may also be available in other languages.

Please visit our website at <http://www.hioki.com>.

*2 The latest version can be downloaded from our website.

*3 Apply to battery cover or other location as desired.

Options

The following options are available for the instrument. Contact your authorized Hioki distributor or reseller when ordering.

Model 9772 Pin Type Lead

The lead's pins are arranged parallel to each other. It is a strong, wear-resistant lead.

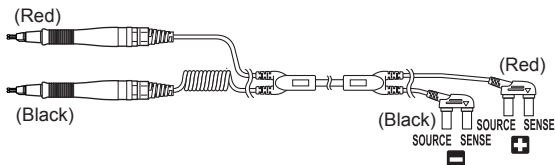

Model L2020 Pin Type Lead

This pin type lead has a four-terminal structure and can be used in confined spaces where the measurement target is difficult to reach.

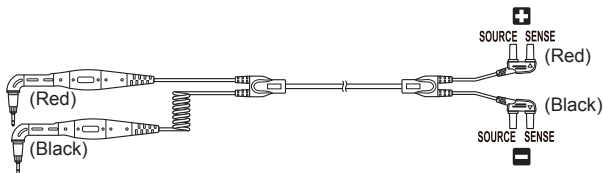

Model 9465-10 Pin Type Lead

This pin type lead has a four-terminal structure.

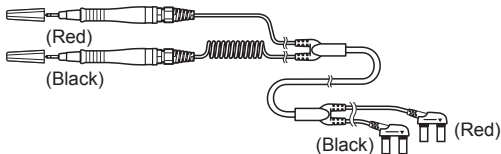

Model 9772-90 Tip Pin

The replacement tip pin for the model 9772 Pin Type Lead.

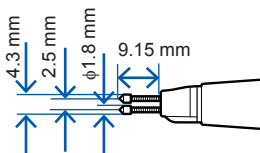

Model 9465-90 Tip Pin

The replacement tip pin for the model 9465-10 and L2020 Pin Type Lead.

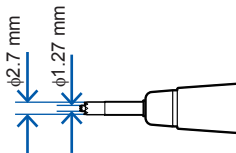

Model 9466 Remote Control Switch

When this switch is attached to the test lead, the instrument can hold the values while measuring them.

Wearable models:

- Model 9465-10 Pin Type Lead
- Model 9772 Pin Type Lead
- Model L2020 Pin Type Lead

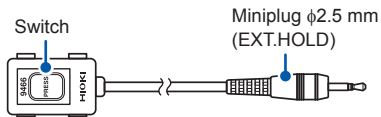

Model Z5038 0 ADJ Board (For models 9772, L2020, and 9465-10)

Hook and loop fastener is necessary separately to stick to the carrying case and use model Z5038.

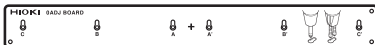

Model 9460 Clip Type Lead with Temperature Sensor

Resistance, voltage, and temperature can be measured simultaneously with this lead.

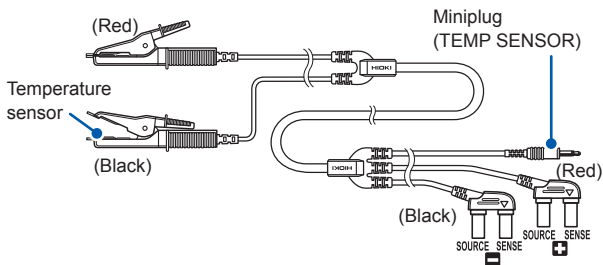

Model 9467 Large Clip Type Lead

These can clip the test lead to the measurement target with a thick bar. Four-terminal measurement can be conducted just by clipping the lead to the target.

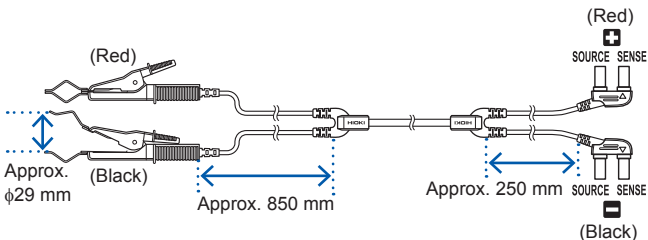

Safety Information

This instrument is designed to conform to IEC 61010 Safety Standards, and has been thoroughly tested for safety prior to shipment. However, using the instrument in a way not described in this manual may negate the provided safety features.

Before using the instrument, be certain to carefully read the following safety notes:

DANGER



Mishandling during use could result in injury or death, as well as damage to the instrument. Be certain that you understand the instructions and precautions in the manual before use.

WARNING



With regard to the electricity supply, there are risks of electric shock, heat generation, fire, and arc flash due to short circuits. If persons unfamiliar with electricity measuring instrument are to use the instrument, another person familiar with such instruments must supervise operations.

Protective gear







WARNING







This instrument is measured on a live line. To prevent electric shock, use appropriate protective insulation and adhere to applicable laws and regulations.

Notation



In this document, the risk seriousness and the hazard levels are classified as follows.

 DANGER	Indicates an imminently hazardous situation that will result in death or serious injury to the operator.
 WARNING	Indicates a potentially hazardous situation that may result in death or serious injury to the operator.
 CAUTION	Indicates a potentially hazardous situation that may result in minor or moderate injury to the operator or damage to the instrument or malfunction.
IMPORTANT	Indicates information related to the operation of the instrument or maintenance tasks with which the operators must be fully familiar.
	Indicates a high voltage hazard. If a particular safety check is not performed or the instrument is mishandled, this may give rise to a hazardous situation; the operator may receive an electric shock, may get burnt or may even be fatally injured.
	Indicates prohibited actions.
	Indicates the action which must be performed.
HOLD	Indicates a control key.
[HOLD]	Indicates the display on the screen.

Symbols on the instrument

	Indicates cautions and hazards. When the symbol is printed on the instrument, refer to a corresponding topic in the Instruction Manual.
	Indicates a fuse.
	Indicates a grounding terminal.
	Indicates DC (Direct Current).

Symbols for various standards

	Indicates the Waste Electrical and Electronic Equipment Directive (WEEE Directive) in EU member states.
	Indicates that the product conforms to regulations set out by the EU Directive.
	Indicates that the product incorporates Bluetooth® wireless technology.
FCC ID	FCC ID Indicates the ID number of the wireless module certified by the U.S. Federal Communications Commission (FCC).
IC	Indicates the identification number of a wireless module approved by Industry Canada (IC).

Screen Display

The instrument screen displays the alphanumeric characters as follows.

A	B	C	D	E	F	G	H	I	J	K	L	M	N	O	P	Q	R	S	T	U	V	W	X	Y	Z
A	b	C	d	E	F	G	H	I	J	K	L	M	N	O	P	Q	R	S	T	U	V	W	X	Y	Z

1	2	3	4	5	6	7	8	9	0
1	2	3	4	5	6	7	8	9	0

A different display is used in the case below:

<i>bl uEt ooth</i>	:	Displays when setting the Bluetooth® communication.
<i>CLr Unit</i>	:	Displays when clearing the stored data.
<i>FA IL</i>	:	Displays when setting the comparator buzzer to FAIL.

Accuracy

We define measurement tolerances in terms of f.s. (full scale), rdg. (reading) and dgt. (digit) values, with the following meanings:

f.s.	(maximum display value or range) The maximum displayable value. This is usually the name of the currently selected range.
rdg.	(reading or displayed value) The value currently being measured and indicated on the measuring instrument.
dgt.	(resolution) The smallest displayable unit on a digital measuring instrument, i.e., the input value that causes the digital display to show a "1" as the least-significant digit.

Measurement Categories

To ensure safe operation of measuring instruments, IEC 61010 establishes safety standards for various electrical environments, categorized as CAT II to CAT IV, and called measurement categories.

DANGER



- **Using a measuring instrument in an environment designated with a higher category than the rating of the instrument could result in a severe accident, and must be carefully avoided.**
- **Using a measuring instrument without categories in an environment categorized as CAT II to CAT IV could result in a severe accident, and must be carefully avoided.**

- CAT II: When directly measuring the electrical outlet receptacles of the primary electrical circuits in equipment connected to an AC electrical outlet by a power cord (portable tools, household appliances, etc.).
- CAT III: When measuring the primary electrical circuits of heavy equipment (fixed installations) connected directly to the distribution panel, and feeders from the distribution panel to outlets.
- CAT IV: When measuring the circuit from the service drop to the service entrance, and to the power meter and primary overcurrent protection device (distribution panel).

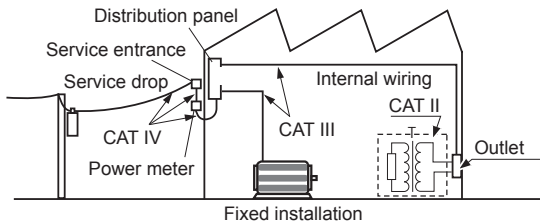

The instrument's labeling does not indicate its suitability for use in any particular measurement category.

Operating Precautions

Follow these precautions to ensure safe operation and to obtain the full benefits of the various functions.

Ensure that your use of the product falls within the specifications not only of the instrument itself, but also of any accessories, options, batteries, and other equipment being used.

Installing the instrument

CAUTION

Installing the instrument in inappropriate locations may cause a malfunction of instrument or may give rise to an accident. Avoid the following locations.

- Exposed to direct sunlight or high temperature
- Exposed to corrosive or combustible gases
- Exposed to a strong electromagnetic field or electrostatic charge
- Near induction heating systems (such as high-frequency induction heating systems and IH cooking equipment)
- Susceptible to vibration
- Exposed to water, oil, chemicals, or solvents
- Exposed to high humidity or condensation
- Exposed to high quantities of dust particles



Do not place the instrument on an unstable table or an inclined place. Dropping or knocking down the instrument can cause injury or damage to the instrument.

Preliminary checks

DANGER

If the test lead or the instrument is damaged, there is a risk of electric shock. Before using the instrument perform the following inspection:

- Before using the instrument check that the coating of the test leads are neither ripped nor torn and that no metal parts are exposed. Using the instrument under such conditions could result in electric shock. Replace the test leads with those specified by our company.
- Verify that the instrument operates normally to ensure that no damage occurred during storage or shipping. If you find any damage, contact your authorized Hioki distributor or reseller.



Precautions for Transportation

During shipment of the instrument, handle it carefully so that it is not damaged due to a vibration or shock.

Handling the instrument

DANGER

 To avoid electric shock, do not remove the instrument's case. The internal components of the instrument carry high voltages and may become very hot during operation.

⚠ CAUTION



To avoid damage to the instrument, protect it from physical shock when transporting and handling. Be especially careful to avoid physical shock from dropping.

Precautions for measurement

⚠ DANGER



To avoid electric shock, be careful to avoid shorting live lines with the test leads.

⚠ WARNING

- Do not use the instrument and test lead with circuits that exceed its ratings or specifications. Doing so may cause damage, resulting in an electric shock.
- Do not measure any voltage that would exceed the instrument's maximum input voltage (terminal-to-terminal) or maximum rated terminal-to-ground voltage of 60 V.



Maximum input voltage
(terminal-to-terminal) 60 V DC

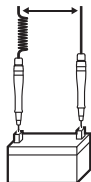

Maximum rated terminal-to-ground voltage 60 V DC



- Do not measure AC voltage.

 **WARNING**

- Be sure to connect the test lead correctly.
- Wear gloves of rubber or similar material during measurement.
- Ensure sufficient ventilation when measuring batteries in the measurement room to prevent explosions. Sparks may occur when the test leads are connected to batteries, which can ignite any accumulated inflammable gases such as hydrogen.

 **CAUTION**

- After measuring a high-voltage battery, first short the test leads together to discharge the DC elimination capacitor connected across the leads before continuing to measure a low-voltage battery. Otherwise an excess voltage may be applied to the low-voltage battery causing damage to the battery.



- To avoid damage to the instrument, do not apply voltage to the EXT.HOLD and TEMP.SENSOR terminal.

IMPORTANT

Do not place the test leads in contact with the measurement terminals of a battery that is leaking fluid. Doing so may cause a degradation in instrument functionality due to exposure to electrolyte from the leaking battery.

Handling the test leads

CAUTION

Do not apply force when the pin type lead tip is in contact with the battery at a tilted angle.

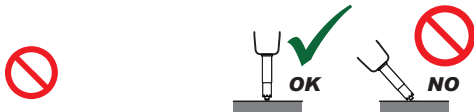

Avoid subjecting the temperature probe tip to physical shock, and avoid sharp bends in the leads. These may damage the probe or break a wire.

IMPORTANT

When using the instrument, use only the test leads with those specified by our company. Using other test leads may result in incorrect measurements due to loose connections or other reasons.

Zero adjustment board

WARNING



To prevent short-circuit accidents, do not place the zero adjustment board on top of the battery.

Batteries and fuses

WARNING

- To avoid electric shock when replacing the batteries and fuse, first disconnect the test leads from the object to be measured, and then remove the case.
- To prevent instrument damage or electric shock, use only the screw for securing the battery cover in place that are originally installed. If you have lost a screw or find that a screw is damaged, please contact your Hioki distributor for a replacement.
- Replace the fuse only with one of the specified type, characteristics, rated current, and rated voltage. Do not use fuses other than those specified (especially, do not use a fuse with higher-rated current) or do not short circuit and use the fuse holder. Doing so may damage the instrument and result in bodily injury.



Fuse type: 216.630, Littelfuse Inc., fast-acting, rating 250 V / F 630 mA, circuit breaker rating 1500 A



- Battery may explode if mistreated. Do not short-circuit, recharge, disassemble or dispose of in fire.

CAUTION

Poor performance or damage from battery leakage could result. Observe the cautions listed below:

- Do not mix old and new batteries, or different types of batteries.
- Be careful to observe the battery polarity during installation.
- Do not use batteries after their recommended expiry date.
- Do not allow weak batteries to remain in the instrument.
- Replace batteries only with the specified type.
- Remove the batteries from the instrument if it is to be stored for a long time.



Handle and dispose of batteries in accordance with local regulations.

CD disc precautions

- Exercise care to keep the recorded side of discs free of dirt and scratches. When writing text on a disc's label, use a pen or marker with a soft tip.
- Keep discs inside a protective case and do not expose to direct sunlight, high temperature, or high humidity.
- Hioki is not liable for any issues your computer system experiences in the course of using this disc.

1

Overview

1.1 Measuring Battery Wear

IMPORTANT

To determine if a battery is worn out, first measure the internal resistance of a new or good battery.

When the battery is worn out, the internal resistance rises to **approximately 1.5 to 2 times** its default value (reference values).

The graph below shows the relation between storage capacity and default value of internal resistance in a lead-acid battery. "CS", "HS", and "MSE" denote JIS (Japanese Industrial Standard) lead-acid battery types.

The internal resistance of an MSE (sealed stationary lead-acid battery) can be read at **approximately 1 mΩ (100 Ah) and approximately 0.13 mΩ (1000 Ah)**.

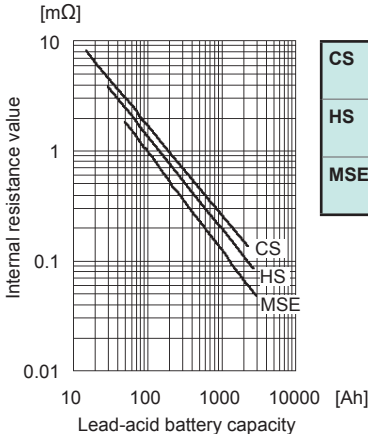

CS	Clad type stationary lead-acid battery
HS	High discharge rate stationary lead-acid battery
MSE	Sealed stationary lead-acid battery

- The warning limit (WARNING) for an MSE (sealed stationary lead-acid battery) is when the internal resistance reaches approximately 1.5 times its default value. The failure limit (FAIL) varies for each manufacturer.
- Default value of internal resistance may vary among batteries with the same capacity, depending on the model or manufacturer. Use the graph on the previous page as reference.
- Internal resistance warning limit (WARNING) and failure limit (FAIL) varies for each manufacturer.

Source: Battery technician certification textbook, Battery Association of Japan (BAJ)

Comparator function (p. 55)

With the comparator function, the battery measurement values can be compared with the present threshold values to determine which ranges those values fall within: PASS, WARNING, or FAIL.

In open (liquid) stationary lead-acid batteries such as CS, HS, and alkaline lead-acid batteries, variations in internal resistance are small compared with sealed stationary lead-acid batteries, and sometimes it is difficult to determine worn out state of the batteries.

1.2 Overview

This instrument measures internal resistance, voltage, and terminal temperature* of lead-acid, nickel-cadmium, nickel-hydrogen, and other types of batteries, enabling you to determine if the battery is worn out.

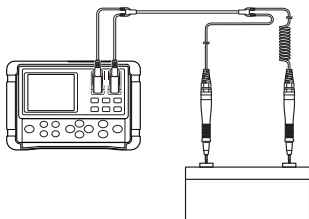

* Temperature measurement requires the optional model 9460 Clip Type Lead with Temperature Sensor.

The measurement data can be copied to a computer by connecting the instrument to a computer after measurement with the USB cable provided. Also, users can view the data on their smart phones or tablets with the Bluetooth® Communication function.

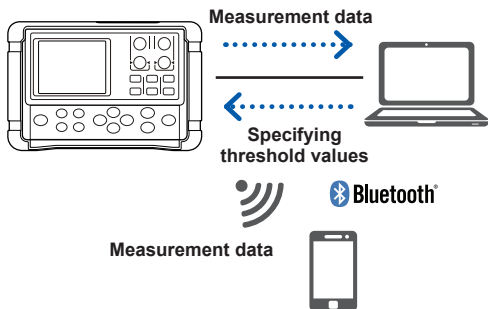

1.3 Features

● **Enables measurement without shutting down UPS systems**

This instrument uses high-precision AC resistance measurement technology, and noise reduction technology. Time required for measurement is reduced since the instrument is capable of measuring live wires without requiring the UPS system to be shut down.

● **Reliable measurement values**

This instrument is capable of obtaining reliable measurement values without being affected by lead or connector resistance because it uses the AC 4-terminal method to measure internal resistance.

● **Simultaneous display of resistance, voltage, and temperature**

Without changing functions, this instrument can display battery internal resistance, voltage, and terminal temperature simultaneously. Temperature measurement requires the optional model 9460 Clip Type Lead with Temperature Sensor.

● **Comparator function**

The comparator function enables you to set threshold values for internal resistance and voltage. This can determine battery wear more easily.

● **Large memory capacity**

This instrument can store up to 6000 sets of data combining presently measured values (resistance, voltage, temperature, and comparator measurement results). It can be used to measure up to 12 units of 500-cell cubicles.

● **Auto-memory function**

Turning this function on stores the measurement values in the instrument's internal memory automatically, the instant when each set of data is held. This can lead to increased operational efficiency.

● **PC interface**

Measurement data can be loaded into a computer.

● **Bluetooth® Communication function**

Users can view measurement values on their smart phones and tablets.

● **Model L2020 Pin Type Lead (optional)**

The model L2020 pin type lead is L-shaped and handy to measure in confined location.

● **Model 9772 Pin Type Lead (optional)**

Using the model 9772 Pin Type Lead with a pin tip designed to fit in holes of $\phi 5$ mm enables measurement without removing terminal covers. Measurement is possible in virtually any location because the pin can be inserted diagonally in hard-to-reach places.

● **Model 9466 Remote Control Switch (optional) for storing measurement values**

The model 9466 Remote Control Switch makes it possible to hold and store measurement values by pressing a key. This is useful when both hands of the operator are busy.

1.4 Names and Functions of Parts

Front

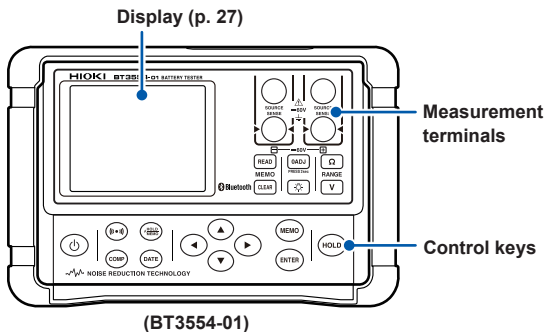



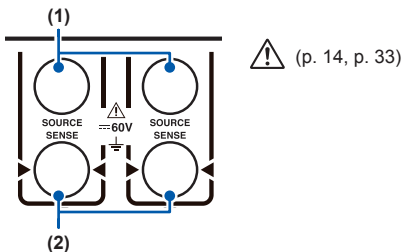







Measurement terminals







- | | |
|-----------------------------|--|
| (1) SOURCE terminals | The SOURCE side of the banana plug on the test lead is connected to this terminal. |
| (2) SENSE terminals | The SENSE side of the banana plug on the test lead is connected to this terminal. |

Control keys

	Pressing	Pressing and holding (at least 1 second)	Pressing and holding the key while turning on the power
	-	Turns the power ON/OFF.	-
	Turns the comparator buzzer ON/OFF.	-	-
	Turns the comparator ON/OFF.	Sets comparator threshold values.	-
	Turns the auto-hold and auto-memory features ON/OFF.	-	Displays the setup screen for the disconnection detection function.
	Displays the clock.	Adjusts the clock.	-
	Selects a configuration setting. Changes the value. Uses the right or left key to select a digit.	-	-
	Turns on the memory storage. Stores measurement value when it is retained.	Turns off the memory storage.	Turns the Bluetooth [®] Communication function ON/OFF (for BT3554-01).
	Confirms the settings.	-	Displays the Serial No.
	Holds or cancels the measurement values.	-	Displays the APS setup screen.
	Reads or cancels stored measurement values.	-	-
	Deletes the settings.	Deletes the last stored data.	Displays the system reset screen.

Names and Functions of Parts

	Pressing	Pressing and holding (at least 1 second)	Pressing and holding the key while turning on the power
	-	Starts or cancels zero adjustment. (press and hold for at least 2 seconds.)	-
	Turns the backlight ON/OFF.	-	-
	Changes the resistance range.	-	Displays the setup screen for the noise frequency avoidance function.
	Changes the voltage range.	-	Displays all LCD screen elements.

Display

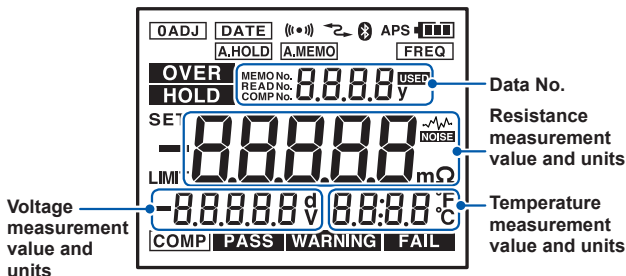

OADJ	Zero adjustment ON	MEMO No.	Saved memory number
DATE	Clock display and setting	READ No.	Read memory number
(••••)	Comparator buzzer ON	COMP No.	Comparator number
↻	Now communicating	USED	Selected memory number is in use
Bluetooth	Bluetooth® function ON (only for BT3554-01)	SET	Setting each function
APS	Auto Power Save ON	LIMIT	For setting comparator threshold values
Battery	Battery level	NOISE	For noise frequency avoidance function
A.HOLD	Auto-hold ON	COMP	Comparator ON
A.MEMO	Auto-memory ON	PASS	PASS result
FREQ	Noise frequency avoidance function ON	WARNING	WARNING result
OVER	Input overflow	FAIL	FAIL result
HOLD	Retain measurement value		

Indicators other than those shown above may also light up when all the indicators on the display are shown, but only the above indicators are used by the instrument.

Top view

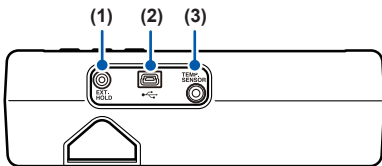

(1) EXT.HOLD terminal	Connects the model 9466 Remote Control Switch (optional).
(2) USB terminal	Connects the USB cable.
(3) TEMP.SENSOR terminal	Connects the miniplug of the model 9460 Clip Type Lead with Temperature Sensor (optional).

Rear view

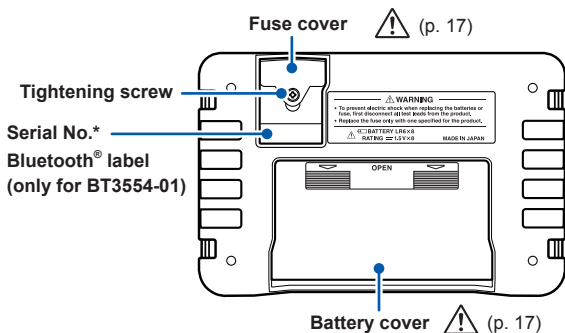

* The serial number consists of 9 digits. The first two (from the left) indicate the year of manufacture, and the next two indicate the month of manufacture. Required for production control. Do not peel off the label.

1.5 Dimensions

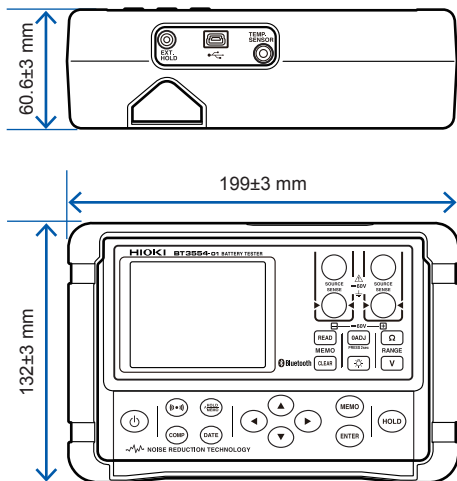

1

2

Measurement Preparations

2.1 Attaching the Neck Strap

Operators can hang the instrument around their neck by attaching the neck strap. Attach the neck strap as described below.

- 1** Switch off the instrument and remove the test leads.
- 2** Pass the neck strap through the 2 attachments and fasten it in place with the buckles (2 on each side of the instrument).
- 3** Adjust the length of the neck strap.

The instrument can be placed in the carrying case even with the neck strap attached.

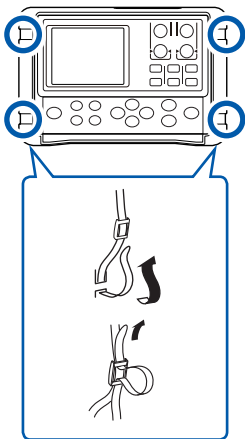

2.2 Installing/Replacing Alkaline Batteries

When using the instrument for the first time, insert 8 LR6 (AA) alkaline batteries. Before attempting measurement, check to make sure that the battery level is sufficient. If the battery level is low, replace the batteries with new ones.

- The  indicator flashes when alkaline battery voltage becomes low. Replace the batteries as soon as possible.
- In this document, the "alkaline battery" means the LR6 (AA) battery to run the instrument, and the "battery" refers to the measurement target.

- 1 Switch off the instrument and remove the test leads.

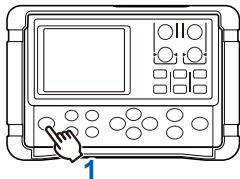

- 2 Open the alkaline battery cover on the rear of the instrument.

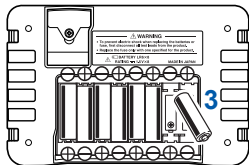

- 3 Insert 8 alkaline batteries, taking care of the proper polarities.

- 4 Replace the alkaline battery cover.

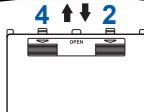

2.3 Connecting the Test Lead

WARNING



To avoid electric shocks, be sure to connect the test leads properly.

Connect the test leads to the instrument. Be sure to connect all 4 terminals: SOURCE (+,-) and SENSE (+,-).

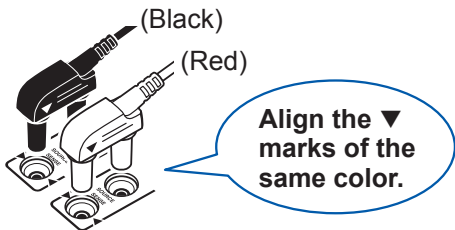

When using the optional model 9460 Clip Type Lead with Temperature Sensor, connect the miniplug to the TEMP.SENSOR terminal. For more information, see “Measuring the Temperature” (p. 53).

Connecting a Pin Type Lead and the Model 9466 Remote Control Switch

The Pin Type Lead (Models 9465-10, 9772, and L2020) and the optional model 9466 Remote Control Switch can be combined together as shown below.

Connect the remote control switch to the probe of the lead, and join the 2 cables using the supplied spiral tube.

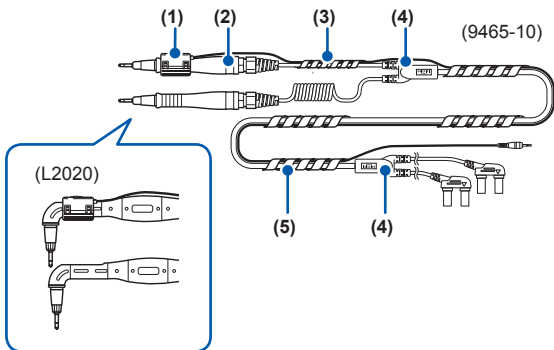

(1) **Model 9446 Remote Control Switch**

(2) **Probe**

(3) **Spiral tube (small)**

Bundle up the center of the lead between the probe and junction with a spiral tube.

(4) **Junction**

(5) **Spiral tube (large)**

Arbitrarily bundle up the lead between junctions.

2.4 Turning the Power ON/OFF

Press and hold the  key (for at least 1 second) to turn the power on or off. Check the clock settings when using the instrument for the first time.

Power: ON

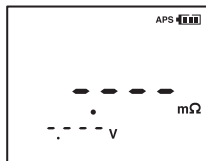

Power: OFF



2

The  indicator flashes when alkaline battery voltage becomes low. Replace the batteries as soon as possible.

2.5 Clock Function

The date and time can be displayed by pressing the **DATE** key. Check the clock settings when using the instrument for the first time. The time is displayed using a 24-hour clock. The instrument's calendar recognizes leap years automatically.

Turning the Date and Time Display ON/OFF

Press the **DATE** key to switch date-and-time display on or off.

Date and time display: ON

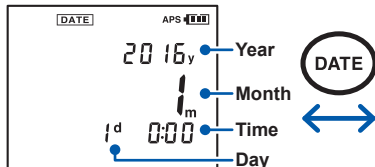

(00:00 on January 1, 2016)

Date and time display: OFF

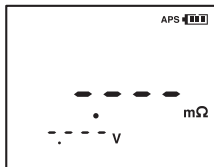

Adjusting the Date and Time

1



(Press the key for at least 1 second.)
Enters the date and time setup mode.

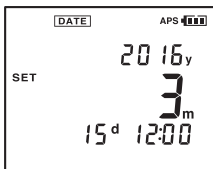

2



Select the values.

3



Confirm the specified values.



Date and time will not be set if you exit the clock setup screen without pressing the **ENTER** key.

To ensure safe operation, be sure to read "Operating Precautions" (p. 12) before starting the measurements.

- Internal battery resistance varies considerably depending on charge or discharge status. To increase measurement accuracy, make measurements under similar conditions (for example, a fully charged battery).
- Lead-acid batteries (measuring objects) have high levels of terminal resistance. For this reason, resistance values may differ between the case and the tip of the terminal. Be sure to connect the test lead to the terminals at a fixed location. For more information, see "Effects of Current Density" (p. Appx.5).
- Use the optional model 9460 Clip Type Lead with Temperature Sensor to measure the battery temperature. Or, use a non-contact thermometer, such as a radiation thermometer, for safety.
- Measurement may not be possible for insulated terminals, due to insufficient flow of current for measurement. In such a case, clean the terminal (remove the insulation) before measurement.

3.1 Pre-operation Inspection

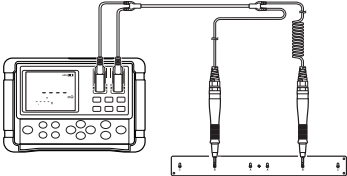
Before using the instrument, verify that it operates normally to ensure that no damage occurred during storage or shipping. If you find any damage, contact your authorized Hioki distributor or reseller.

Inspection item	Method of checking
<p>Is the fuse burned out?</p> <p>Is the test lead disconnected?</p>	<p>Touch the test lead to the zero adjustment board. If the resistance display still shows [----], the fuse might be burned out or the test lead may be disconnected. If so, replace it with a new one.</p> 
<p>Is the battery level sufficient?</p>	<p>At the upper right-hand area of the screen,  indicates the present alkaline battery status. If  is displayed, the alkaline batteries need to be replaced soon. Be sure to have spare alkaline batteries available.</p>
<p>Inspecting batteries</p>	<p>Measurement may not be possible for insulated terminals, due to insufficient flow of current for measurement. In such a case, clean the terminal (remove the insulation) before measurement.</p>

3.2 Setting the Measurement Range

Set resistance and voltage measurement ranges as described below.

Resistance range	3 m Ω /30 m Ω /300 m Ω /3 Ω
Voltage range	6 V/ 60 V
Temperature range	(Single range) Because temperature measurement uses a signal range, range setting is not required.

Press the Ω key or V key to display the present settings. Press the key repeatedly to cycle through the ranges.

3

Resistance range

3.000 m Ω \rightarrow 30.00 m Ω



3.000 Ω \leftarrow 300.0 m Ω

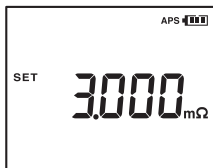

Voltage range

6.000 V



60.00 V

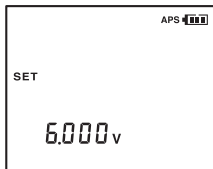

When there is no activity for approximately 1 second, the settings on the display get confirmed and returns to the measurement screen.

3.3 Adjusting Zero Value (Zero Adjustment)

The zero adjustment function displays subsequent measurement results using the measured value (correction value) obtained when it was performed as zero.

The defined accuracy does not require zero adjustment to be performed when using accessory or optional test leads, but the process should be performed in the following instances:

- When you wish to increase measurement accuracy*
- When using test leads that are not an accessory or option, or when using test leads whose length has been extended

* For the 3 m Ω range, the accuracy specifications differ depending on whether zero adjustment has been performed.

For more information, see "8 Specifications" (p. 89).

- Performing zero adjustment adjusts the zero points of all ranges.
- Even after the instrument is turned off, the correction values are retained and the zero adjustment function is not canceled.
- After replacing the test lead, be sure to perform zero adjustment prior to measurement.
- Be sure to use the included or optional zero adjustment board when performing zero adjustment.
- Be sure to keep the test lead shorted during zero adjustment.
- Keep the tip of the test lead away from the metal components.

Shorting Methods for Various Test Leads

For Pin Type Leads

Use the included or optional zero adjustment board. The zero adjustment can be achieved using the AC 4-terminal method.

- 1 Select 2 holes on the zero adjustment board which are at the same distance as the terminals on the battery to be measured.

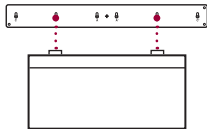

- 2 Push the test leads in a direction perpendicular to the holes so that it is symmetrical to the central plus sign (+) on the zero adjustment board.

Model 9465-10 or L2020 Pin Type Lead

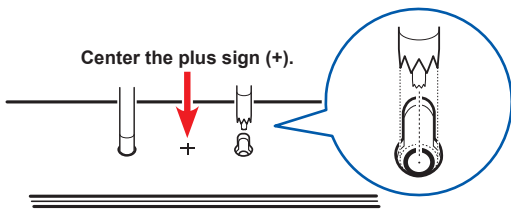

Model 9772 Pin Type Lead

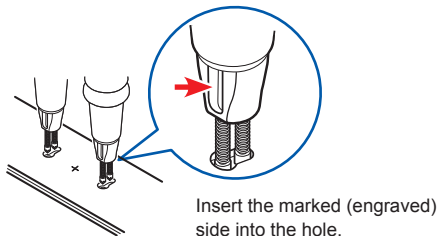

- Keep the zero adjustment board at least 10 centimeters away from the instrument.
- Be sure to use the included or optional zero adjustment board when performing zero adjustment.
- Be sure to connect each of the SOURCE and SENSE terminals by inserting the tip of the pin into the holes on the zero adjustment board. (See the figure below.)

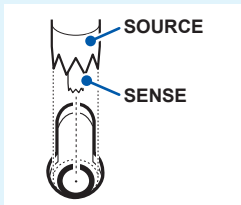

- Do not place the zero adjustment board on top of the battery or any metal. Electromagnetic induction effect could result in unstable measurement values. In such a case, keep the zero adjustment board away from any metal.
- Performing zero adjustment by connecting the tips of pin-type leads or using a metal sheet other than the included zero adjustment board will result in inaccurate adjustment of the zero point.
- When the distance between the terminals on the battery (measurement target) is more than the distance between the holes on the zero adjustment board, use the holes at both corners to perform zero adjustment.
- Consider the zero adjustment board to be a consumable. Replacing it with a new one after using it around 700 times is recommended.

For Clip Type Leads

Perform zero adjustment by engaging red and black clips together.

Model 9460 Clip Type Lead with Temperature Sensor

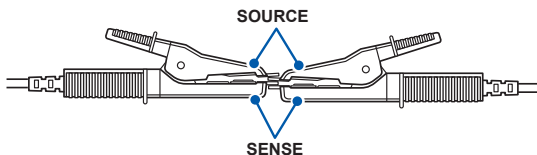

Model 9467 Large Clip Type Lead

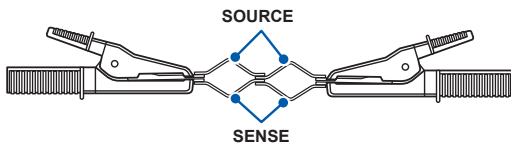

Performing Zero Adjustment

- 1 Check to ensure that the test leads are connected properly.

Disconnect any leads connected to the measurement target.

- 2 Press the **0ADJ** key for at least 2 seconds.

This enables the standby state for acquiring the correction values.

- 3 While **[0AdJ]** is flashing, short the test leads using the zero adjustment board.

For more information, see "Shorting Methods for Various Test Leads" (p. 41).

If the test leads are not shorted while the display is blinking, it will result in an error.

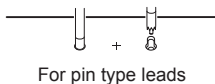
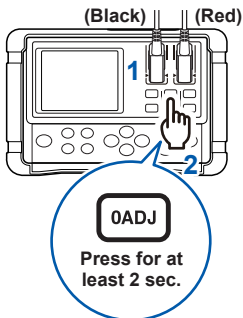

The instrument automatically begins obtaining correction values. When the zero adjustment operation is complete, [0ADJ] is lit up and the instrument returns to the measurement mode:

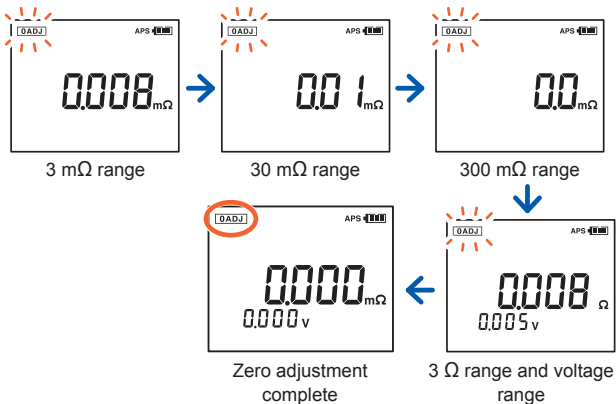

3

- Keep the test leads shorted until the zero adjustment operation is complete.
- The zero adjustment starts even if a key is pressed after the test lead has been shorted.

Zero Adjustment Troubleshooting

Check items	Solution
Is the fuse burned out?	If so, replace it with a new fuse. (p. 109)
Do the correction values obtained exceed 300 counts in either resistance or voltage range?	Ensure that the test lead is properly connected to the instrument.
	The test lead may be disconnected. If so, replace it with a new one.
	Try cleaning the zero adjustment board.
Did you short the test leads properly while the instrument is in standby for correction values?	While the instrument is in standby for correction values (for approximately 10 seconds), short the test leads using the zero adjustment board to perform zero adjustment.

Canceling the Zero Adjustment Operation

Pressing the **0ADJ** key for at least 2 seconds while the zero adjustment function is active, cancels the zero adjustment operation.

Zero adjustment: ON

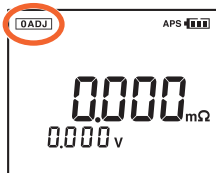

Zero adjustment: OFF

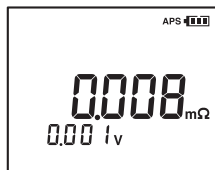

3.4 Retaining the Displayed Values

- When the warning display or voltage is displayed as [----], the values cannot be retained.
- Changing any of the settings cancels retaining.
- Turning off the power cancels retaining.

Measurement values displayed on the screen can be retained. Pressing the **HOLD** key will light up **[HOLD]**, and retain the measurement values.

Retaining function: OFF

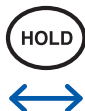
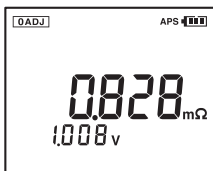

Retaining function: ON

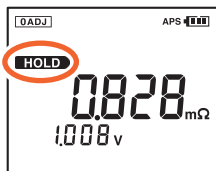

Canceling the Retaining State

Pressing the **HOLD** key again cancels the retaining state.

The auto-hold function can be used to automatically recognize the stability of measurement values and retain them. For more information, see "6.2 Auto-hold Function" (p. 75).

When retaining with the Model 9466 Remote Control Switch

The optional model 9466 Remote Control Switch is available for the operation in the same way as when using the **HOLD** key.

Model 9466 Remote Control Switch

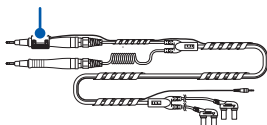

- 1 Disconnect the test leads from the battery (measurement target).
- 2 Insert the miniplug of the model 9466 Remote Control Switch into the EXT.HOLD terminal.
- 3 Connect the connectors of the test leads to the instrument.

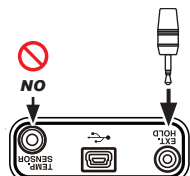

Top of the instrument

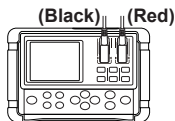

- 4 Press the **PRESS** button on the model 9466 Remote Control Switch.

The measurement value is retained.

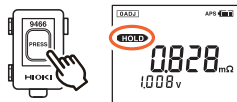

Canceling the retaining state



Press the **PRESS** button on the model 9466 Remote Control Switch, or the **HOLD** key on the instrument.

3.5 Determining Battery-wear Judgment Values

To determine if a battery is worn out, first measure the internal resistance of a new or good battery, and decide the limits for judging battery wear.

As a battery wears out, its internal resistance increases to **approximately 1.5 to 2 times** (reference value) that of a new or good battery, and voltage values decreases to 90% of the default value. Use these values as guidelines when determining the battery wear judgment values.

Example of the battery wear judgment values

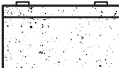
	Default value (PASS)	Warning limit (WARNING)	Failure limit (FAIL)
			
Resistance:	0.5 mΩ	0.75 mΩ	1.0 mΩ
Voltage:	2.0 V	1.8 V	

The above values are examples.

The above values vary depending on the manufacturer and battery model. For more information, see "1.1 Measuring Battery Wear" (p. 19).

3.6 Measuring a Battery (Inspection)

- 1 Prepare the measurement. (p. 31)
- 2 Set the resistance and voltage ranges. (p. 39)
- 3 Perform zero adjustment. (p. 40)

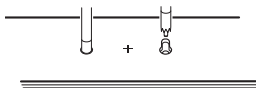

- 4 Connect the test leads to the battery.

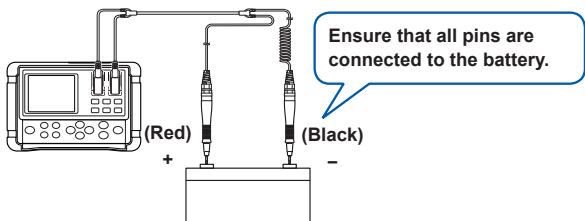

- 5 Read the measurement values.

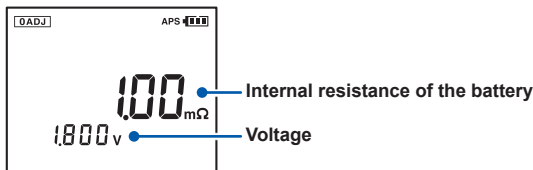

6 Use the measurement values to judge whether the battery is worn out.

Example:

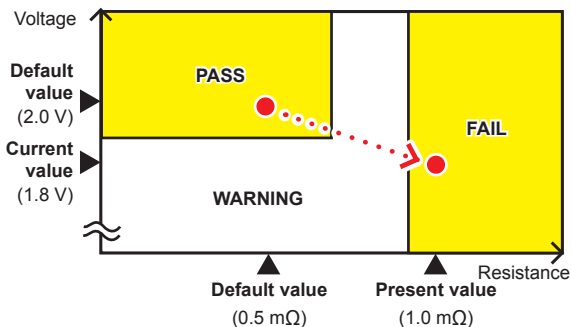

As shown above, this battery needs to be replaced.

To retain measurement values

- ▶ Refer to "3.4 Retaining the Displayed Values" (p. 47).

To store measurement values

- ▶ Measurement values can be stored by pressing the **MEMO** key while the values are being retained. Refer to "5.2 Storing Data in the Memory" (p. 66).

To load the stored data to a computer

- ▶ Refer to "Communications Function" (p. 83).

To set threshold values and judge whether the battery is worn out

- ▶ Based on the wear judgment values, threshold values can be set for judging whether the battery is worn out. Refer to "Comparator Function (Evaluation by Threshold Values)" (p. 55).

Error Measurements

If [----] is displayed and [OVER] flashes on the screen (at the same time, the maximum display values flashes), this does not indicate an error.

[----]	<ul style="list-style-type: none">• If [----] is shown in the resistance display, the test lead is open. Or, a failure such as abnormal current flow due to a disconnected test lead prevents measurements.• The test lead is not connected correctly to the measurement target.• The resistance of the measurement target significantly exceeds the measurement range.
[OVER] display and maximum display value flashes	<ul style="list-style-type: none">• This indicates that it is measuring an exceeded measurement range of either resistance, voltage, or temperature.

Note the maximum open-circuit terminal voltage of the instrument (approximately 5 V maximum) when measuring the resistance of a relay or a connector. There is a possibility that such measurement may damage the oxidized coating on the connector of the measurement target, leading to incorrect measurements.

Warning Display

In the event of an overvoltage input error, the [OVER] display and maximum display value flash, the red backlight lights up, and the buzzer sounds.

3.7 Measuring the Temperature

Use the optional model 9460 Clip Type Lead with Temperature Sensor to measure the battery temperature.

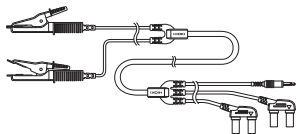

- 1 Connect the connector of the model 9460 Clip Type Lead with Temperature Sensor to the instrument.

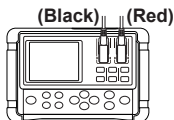

- 2 Connect the miniplug of the model 9460 Clip Type Lead with Temperature Sensor to the TEMP.SENSOR terminal.

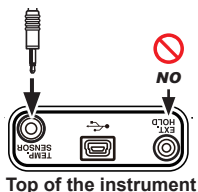

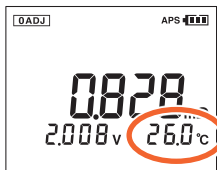

The instrument detects the temperature sensor and automatically displays the temperature.



Changing the temperature display unit

The units of temperature ($^{\circ}\text{C}$ or $^{\circ}\text{F}$) can be changed.

1  Turn off the instrument.

2   Display the setting of the temperature unit.



3  Press the key for at least 3 seconds.

4  **Confirm the setting.**
The instrument is restarted.
The settings will not change if the power is turned off before the settings are applied.



The setting of the temperature unit is retained even after the power is turned off.

4

Comparator Function (Evaluation by Threshold Values)

4.1 Overview

The battery measurement values can be compared with the present threshold values using the comparator function to determine the ranges in which the values fall within: PASS, WARNING, or FAIL. Up to 200 comparator conditions can be set. Refer to “Measuring Battery Wear” (p. 19) for more information on how to determine the threshold values.

A buzzer sounds when a measurement falls within the range of WARNING or FAIL under the default settings. For more information, see “4.4 Setting the Comparator Buzzer” (p. 63).

A resistance warning limit, resistance failure limit, and voltage warning limit are available as the threshold values.

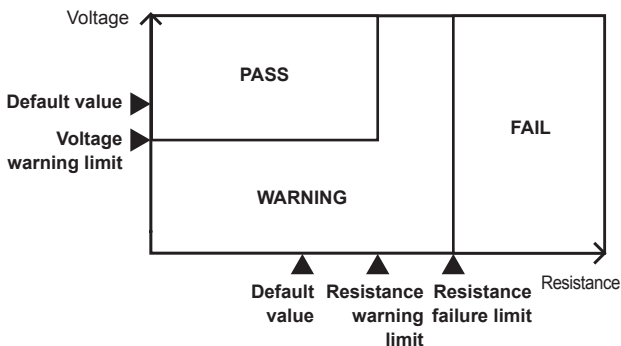



4.2 Turning On the Comparator Function

- 1**  **Press the key.**
The comparator number flashes.

Press the **COMP** key again to return to normal measurements.



- 2**  **Select the comparator number.**
(A number from 1 to 200 can be selected.)

- 3**  **Confirm the settings.**
The comparator function is now turned on.

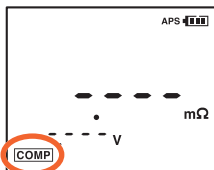
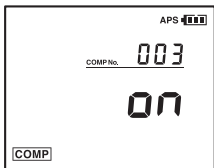

When the comparator function is turned on, the instrument changes to the range specified by the comparator settings.

4.3 Setting Threshold Values for the Comparator

Threshold values can be set for the comparator (resistance warning limit, resistance failure limit, and voltage warning limit).

Example: Threshold values for a battery with the default values* 0.4 Ω and 2 V.

Resistance warning limit: 0.6 Ω (1.5 times of the default value)

Resistance failure limit: 0.8 Ω (2 times of the default value)

Voltage warning limit: 1.8 V

* The default value refers to the value of resistance and voltage for a new battery or a battery in good condition.

Selecting a comparator number

- 1**  **Press the key for at least 1 second.**

The comparator number flashes.

Press the **COMP** key again to return to normal measurements.

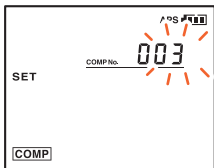



- 2**  **Select the comparator number.**

(A number from 1 to 200 can be selected.)

- 3**  **Confirm the settings.**
The range setup screen is displayed.

Setting the range

1  **Select the resistance range.**
(To shift the decimal point)

2  **Select the voltage range.**
(To shift the decimal point)

3  **Confirm the settings.**
The resistance warning limit and **[WARNING]** flashes.

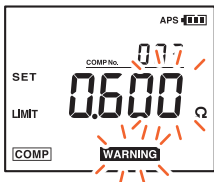
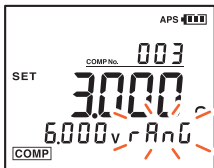

Setting the threshold values

1  **Set the resistance warning limit.**

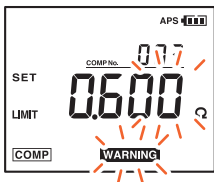

2  **Confirm the settings.**
The resistance failure limit and **[FAIL]** flashes.

3  **Set the resistance failure limit.**

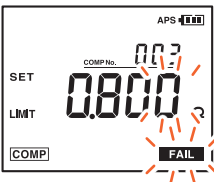

- 4**  **Confirm the settings.**
The voltage warning limit and **[WARNING]** flashes.



- 5**  **Set the voltage warning limit.**

- 6**  **Confirm the settings.**
Returns to the measurement screen, with the comparator function turned on.
The settings are now saved.

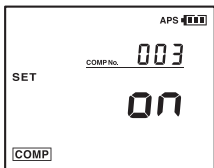

- Voltage is determined using absolute values. Comparison is possible even if the positive and negative electrodes of the test lead are connected to negative and positive terminals, respectively. (Data is stored with the sign.)
- If you set the resistance failure limit to a value that is less than the resistance warning limit as previously set, the warning limit will be set to the same value as the new failure limit.

When a measurement value is determined as "PASS"

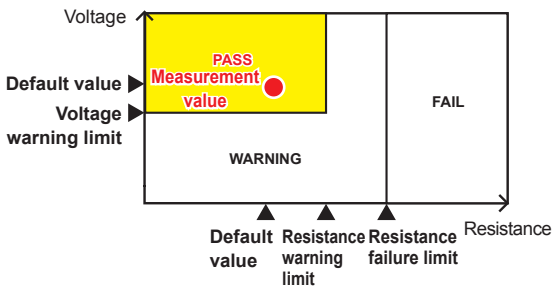

When a measurement value is determined as "WARNING"

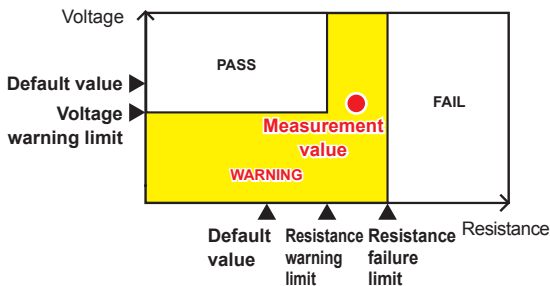

When a measurement value is determined as "FAIL"

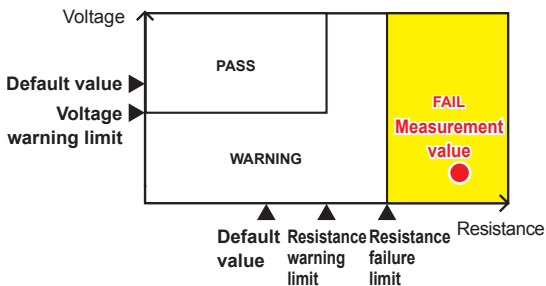

Comparison Table for the Comparator

The result is determined by the display and buzzer as shown in the following table:

	Resistance warning limit	Resistance failure limit	
	Resistance (low)	Resistance (medium)	Resistance (high)
Voltage (high)	PASS	WARNING	FAIL
Voltage warning limit			
Voltage (low)	WARNING	WARNING	FAIL

The boundary conditions are as follows:

$$\begin{array}{l}
 \text{Resistance PASS} \leq \boxed{\text{Resistance warning limit}} < \text{Resistance WARNING} \leq \boxed{\text{Resistance failure limit}} < \text{Resistance FAIL} \\
 \\
 \text{Voltage WARNING} < \boxed{\text{Voltage warning limit}} \leq \text{Voltage PASS}
 \end{array}$$

Examples of how to read the comparator output table

Example 1:

If the measured resistance is less than or equal to the resistance warning limit, and the measured voltage is more than or equal to the voltage warning limit, **[PASS]** is displayed.

Example 2:

If the measured resistance is more than the resistance warning limit and is less than or equal to the resistance failure limit, and the measured voltage is more than the voltage warning limit, **[WARNING]** is displayed and the buzzer sounds.

When the resistance warning limit and resistance failure limit are set to the same value, the boundary conditions are as shown below:

Resistance PASS \leq Resistance warning limit = Resistance failure limit $<$ Resistance FAIL

4.4 Setting the Comparator Buzzer

The buzzer can be enabled in accordance with comparison results when the comparator function is used. The buzzer can be set to sound in the following states. By default, the buzzer is configured to sound when the comparison result is WARNING or FAIL.

In addition to the buzzer, when the comparison result is WARNING or FAIL, the backlight is turned on red.

OFF	The buzzer will not sound regardless of comparison results.
PASS (ON)	The buzzer sounds when comparison results are PASS.
FAIL (ON)	The red backlight turns on, along with the buzzer sounds when comparison results are WARNING or FAIL.

When you press the  key, the present comparator buzzer setting is displayed. Press the key repeatedly to cycle through the settings.

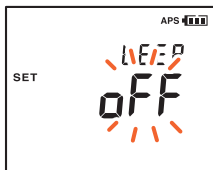
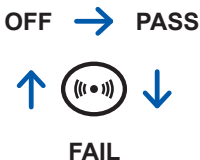

When there is no activity for approximately 1 second, the settings on the display will be confirmed and returns to the measurement screen.

The key tone settings cannot be changed.

4.5 Canceling the Comparator Function

Pressing the **COMP** key when the comparator is turned on cancels the comparator function.

Comparator: ON

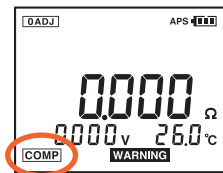

Comparator: OFF

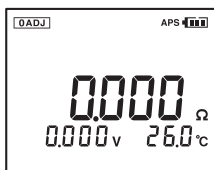

- The range keys cannot be used while the comparator function is turned on.
- If there are no measurement values, [----] is displayed and a comparator judgment cannot be performed.
- Even when the power is turned off, the comparator settings are saved and the comparator will be restored to on when the power is again turned on.

5

Memory Function

5.1 Overview

This instrument can store up to 6000 sets of data combining presently measured values*. After measurement, saved data can be displayed or transferred to a computer.

The structure of the internal memory is as follows:

* Date and time, resistance, voltage, temperature, comparator threshold values, and results of judgment

Memory Structure

Unit name (12 units)	Memory number (500 cells)							
A	1	2	3	...	498	499	500	
B	1	2	3	...	498	499	500	
C	1	2	3	...	498	499	500	
D	1	2	3	...	498	499	500	
E	1	2	3	...	498	499	500	
F	1	2	3	...	498	499	500	
G	1	2	3	...	498	499	500	
H	1	2	3	...	498	499	500	
J	1	2	3	...	498	499	500	
L	1	2	3	...	498	499	500	
N	1	2	3	...	498	499	500	
P	1	2	3	...	498	499	500	

5.2 Storing Data in the Memory

Pressing the **MEMO** key stores the present measurement values.
Handy function: Auto-memory function (p. 76)

1  **Turn on the memory function.**

2  **Select the memory number.**
After a certain period of time of no activity, the settings on the display are confirmed and the instrument returns to the measurement screen. When the memory function is on, you can select the memory number at any time.

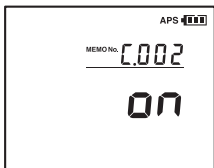

3  **Confirm the settings.**

4  **Retain the measurement values.**
When [----] is displayed, the values cannot be retained.

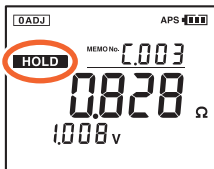

5

MEMO

Store the measurement values.

The measurement values are stored in the cell with the selected memory number.

After the data is stored, the next available memory number is displayed.

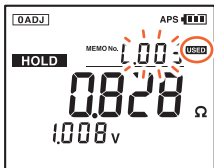

The retaining is now canceled.

- Pressing and holding the **CLEAR** key for 2 or more seconds can clear the last stored data. However, this operation is possible only immediately after the data is stored.
- If **[USED]** is displayed with a memory number, that number will be overwritten.

5

5.3 Canceling the Memory Function

To cancel the memory function when it is on, press and hold the **MEMO** key for at least 1 second. **[oFF]** is displayed, and the instrument returns to the normal mode.

Memory function: ON

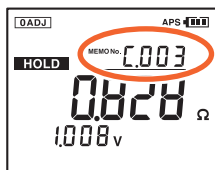

Memory function: OFF

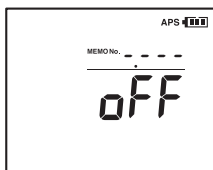

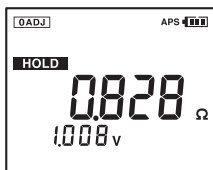

↓
Normal mode



5.4 Reading Out Stored Data

The stored measurement values are displayed after they are read out.

1  Display the memory readout screen.

2  Select the memory number to be read out.
The measurement values for the selected memory number are displayed.

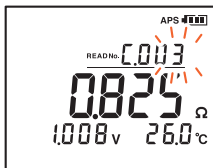

3 To return to the measurement screen, press the **READ** key.

- Press the **DATE** key to check the date and time when the data was stored.
- The comparator result for the data being read out is also displayed.
- You cannot select the number of the memory location in which no data is stored.
- If no data has been stored, [----] is displayed in the memory number display area and the instrument returns to the measurement screen.

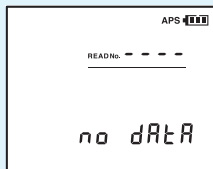

- For data measured using the optional model 9460 Clip Type Lead with Temperature Sensor, the temperature is also displayed.

5.5 Clearing Stored Data

Clearing a Single Set of Data

1 **READ** Display the memory readout screen.



2  Select the number of the memory cell in which you want to clear data.
The measurement values for the selected memory number are displayed.

3 **CLEAR** Press the key once.
If there is no activity for approximately 3 seconds, returns to the readout screen.

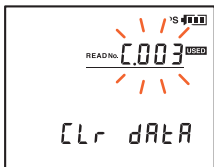

4 **ENTER** Confirm the settings.
The data in the cell with the selected memory number is now cleared.

Clearing Data from Each Unit

1 **READ** Display the memory readout screen.

2  Select the unit in which you want to clear data.

3 **CLEAR** Press the key twice.

If there is no activity for approximately 3 seconds, returns to the readout screen.

4 **ENTER** **Confirm the settings.**
All data stored in the selected unit (500 cells) are cleared.

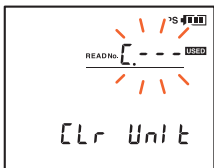

Clearing All Data

- 1** **READ** Display the memory readout screen.



- 2** **CLEAR** Press the key 3 times.

If there is no activity for approximately 3 seconds, returns to the readout screen.





- 3** **ENTER** **Confirm the settings.**
All data (12 units/6000 sets) is now cleared.

6.1 Noise Frequency Avoidance Function

When the noise frequency avoidance function is used, internal resistance with reduced noise is measured automatically.

Turning the Noise Frequency Avoidance Function ON/OFF

1  Turn off the instrument.

2  Display the setup screen for the noise frequency avoidance function.

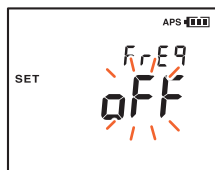

3  Select either [oFF] or [on].



(when off is selected)



(when on is selected)

4  **Confirm the settings.**
 The instrument is restarted.
 The settings will not change if the power is turned off before the settings are applied.



 : Noise frequency avoidance function

Canceling the Noise Frequency Avoidance Function

The function will be canceled when the power is switched off and turned on again.

- When the noise frequency avoidance function is turned on, the time required for measurement may take longer. **[FrEq]** will flash.
- It may not be possible to avoid all noise depending on the type of noise.

6.2 Auto-hold Function

This function automatically recognizes the stability of measurement values and retains them.

Press the **A HOLD/MEMO** key several times to display **[A.HOLD]**.

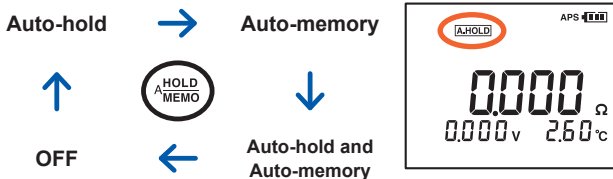

To cancel the retaining, press the **HOLD** key or the **PRESS** button on the model 9466 Remote Control Switch.

- When resistance is displayed as **[----]**, data is not retained automatically.
- Data will not be retained automatically when **[OVER]** and the maximum display value of the resistance are flashing.
- The instrument retains and stores measurement values automatically when the auto-memory function is used together with this function.
- Use the auto-hold function together with the comparator function to determine if **[OVER]** (and the maximum display value) is flashing due to a range setting error. Setting the comparator buzzer to **[FAIL]** is also recommended. For more information, see “4.4 Setting the Comparator Buzzer” (p. 63).

Canceling the Auto-hold function

Press the **A HOLD/MEMO** key several times to hide **[A.HOLD]**.

6.3 Auto-memory Function

This function automatically stores measurement values in memory immediately after they are retained.

Press the **A HOLD/MEMO** key several times to display **[A.MEMO]**.

At this point, the memory function is also turned on.

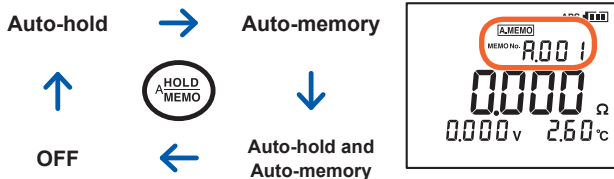

Use the cursor keys to select the memory number of the location in which the data is to be stored. **[USED]** is displayed if a memory number containing data is selected.

- The instrument retains and stores measurement values automatically when the auto-memory function is used together with the auto-hold function.
- Use the auto-memory function together with the comparator function to determine if **[OVER]** (and the maximum display value) are flashing due to a range setting error. Setting the comparator buzzer to **[FAIL]** is also recommended. For more information, see “4.4 Setting the Comparator Buzzer” (p. 63).

Canceling the Auto-memory Function

Press the **A HOLD/MEMO** key several times to hide **[A.MEMO]**.

6.4 Auto Power Save Function (APS)



The auto power save function can be used to reduce power consumption of the instrument. The instrument is turned off automatically if any of the following conditions continues for approximately 10 minutes with no key operation:

- [----] is displayed as a resistance value.
- Data is being retained. (Measurement is suspended.)
- A state other than measurement state. (Any of the setup screens or the data readout screen is displayed.)
- After completion of communication.

[APS] starts flashing 1 minute before the power turns off.

Turning the Auto Power Save function ON/OFF

1  Turn off the instrument.

2  **+**  Display the auto power save setup screen.

3  Select either [oFF] or [on].

4  **Confirm the settings.**
The instrument is restarted.
The settings will not change if the power is turned off before the settings are applied.

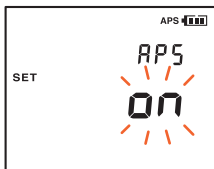

(when on is selected)

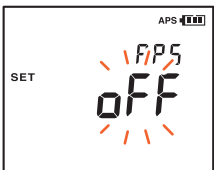

(when off is selected)

- For continuous use of the instrument, set the function to off. (The default setting is on.)
- When the auto power save setup screen is displayed unintentionally, turn off the power and turn it on again. The instrument settings are restored unchanged.

6.5 Backlight

The instrument's backlight can be turned on and off.

Backlight OFF

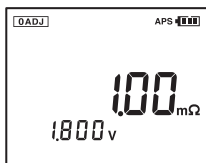

Backlight ON

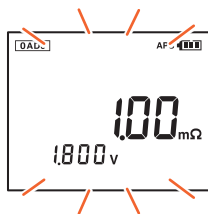

6.6 System Reset

This can be used to restore the instrument to its default settings.

However, note that the following settings will not be cleared:

- Date and time
- Stored measurement data (6000 data sets)
- Comparator threshold values (200 sets)
- Temperature display unit

1  Turn off the instrument.

2  **+** Display the system reset screen.



3  Select **[yES]**.

Select **[no]** to cancel the system reset operation.

4  Confirm the settings.
The instrument is restarted.

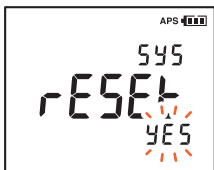
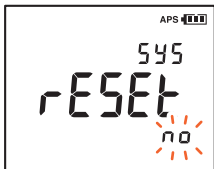

Default Settings (Factory Defaults)

Resistance range	3.000 m Ω
Voltage range	6.000 V
Zero adjustment function	Disabled
Auto-hold function	OFF
Auto-memory function	OFF
Comparator function	OFF
Comparator buzzer setting	WARNING/FAIL (ON)
Auto Power Save function	ON
Temperature display unit	$^{\circ}\text{C}$

- When the system reset screen is displayed unintentionally, turn off the power and turn on again. The instrument settings are restored without resetting the system.
- For more information on how to clear stored measurement data, see “5.5 Clearing Stored Data” (p. 70).

6.7 Battery Level Warning

The battery level of the instrument is displayed at the upper-right corner of the screen.

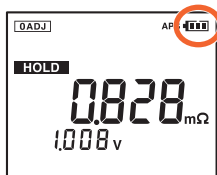

Battery level indicator	Battery status
	Battery fully charged.
	Black charge bars start disappearing from the left as the battery gets drained.
	Battery level is low. Replace the battery as soon as possible.
	(Flashing) Battery is completely drained. Replace with new batteries.

- Using manganese batteries significantly reduces the continuous operating time of the instrument.
- The battery level indicator does not function accurately when nickel-metal hydride batteries are used.
- The battery level indicator serves as an approximate guideline for the continuous operating time.

7.1 Communicating with a Computer

By using the USB cable included with the instrument, you can send data to a computer or control the instrument from a computer. Users can manage the saved data on their smart phones and tablets. (Only for BT3554-01)

For more information, refer to the manual of the CD shipped with the instrument.

The virtual COM port on the computer is used as the USB interface.

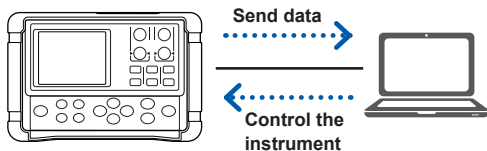

- Insert the connector in the proper direction when connecting the USB cable.
- **[PC]** is displayed on the screen when communication is in progress through the USB cable.
- Do not disconnect the USB cable when communication is in progress. The dedicated computer application software displays a warning message when communication is lost due to cable disconnection. Connect the disconnected USB cable again.

7.2 Communicating with a Smart Phone or Tablet (Only for BT3554-01)

The BT3554-01 is a battery tester with Bluetooth® low energy support. When the Bluetooth® function is enabled, you can review measurement data and create measurement reports on mobile devices (iPhone, iPad, iPad mini™, iPad Pro, iPod touch, and Android™ devices). For more information about this functionality, see the help function in the application software GENNECT Cross.

- 1** Install the GENNECT Cross on your mobile device. (p. 85)



- 2** Enable the Bluetooth® function on the BT3554-01. (p. 86)

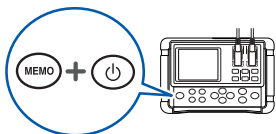

- 3** Launch the GENNECT Cross and pair it with the BT3554-01. (p. 87)

- 4** Select the general measurement or battery function. (p. 88)

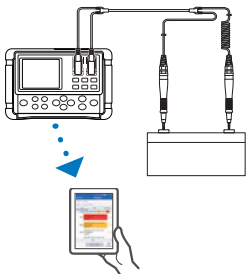

Installing the smartphone app GENNECT Cross

Search for “GENNECT Cross” on the App Store from your iPhone, iPad or other Apple device, or on Google Play™ from your Android device. Then download and install the GENNECT Cross. You will need an Apple ID to download the app on the App Store, or a Google account to download the app on Google Play. For more information about how to register an account, contact the store at which you purchased your device.



- Because the BT3554-01 emit radio waves, use in a country or region where they have not been approved may be subject to fines or other penalties as a violation of applicable laws or regulations. For more information, see the attached “Precautions Concerning Use of Equipment That Emits Radio Waves” or go to our website.
- BT3554-01 availability is limited to certain countries. For more information, contact your authorized Hioki distributor or reseller.
- Bluetooth® communications range varies greatly with distance from obstructions (walls, metal obstruction, etc.) as well as distance from the floor or ground. To ensure stable measurement, verify adequate signal strength.
- Although this app is provided free of charge, downloading or use of the app may incur Internet connection charges. Such charges are the sole responsibility of the user.
- This app is not guaranteed to operate on all mobile devices.

Turning ON/OFF the Bluetooth® function

1  Turn off the instrument.

2  Display the Bluetooth® setup screen.



(when off is selected)

3  Select **[on]**.
To turn off Bluetooth®, select **[oFF]**.

4  Confirm the settings.
The instrument is restarted. The settings will not change if the power is turned off before the settings are applied.



(when on is selected)

 is displayed when the Bluetooth® function is on.

 flashes when the instrument is connected to a mobile device.

Pairing the app with the battery tester (BT3554-01)

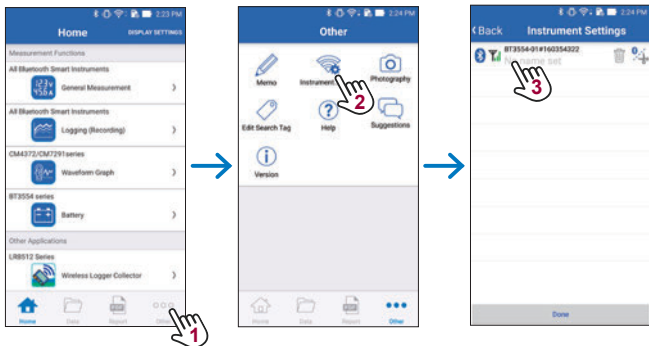

- When the app is launched for the first time (before being paired with any instrument), the connection setup screen will be displayed.
- While the mobile device is displaying the connection setup screen, simply move it close to the BT3554-01 to automatically pair it with the instrument (the app can be paired with up to 8 instruments).
- Allow about 5 to 30 seconds for the instrument to pair with the app after being turned on. If the instrument fails to pair within 1 minute, relaunch GENNECT Cross and cycle the instrument's power.

Making measurements with the Bluetooth[®] function

Select either the general measurement or battery measurement function on the home screen and measure. For more information about each function, see the help function in the GENNECT Cross.

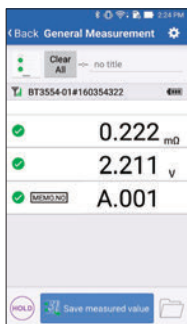

General measurement function

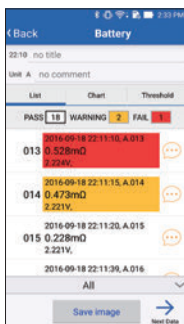

Battery function (List display function)

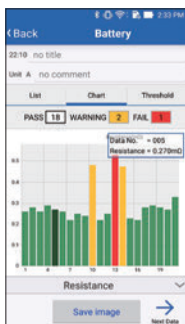

Battery function (Graph display screen)

8.1 General Specifications

Operating environment	Indoors, Pollution Degree 2, altitude up to 2000 m (6562 ft.)
Operating temperature and humidity	Temperature 0°C to 40°C (32°F to 104°F) Humidity 80% RH or less (no condensation)
Storage temperature and humidity	Temperature -10°C to 50°C (14°F to 122°F) Humidity 80% RH or less (no condensation)
Standards	Safety EN 61010 EMC EN 61326
Dielectric strength	1.5 kV AC (cutoff current 5 mA, 1 minute) Between all measurement terminals and USB terminal
Power supply	LR6 (AA) alkaline batteries × 8 Rated supply voltage: 1.5 V DC × 8 Nickel-metal hydride batteries can be used. (However, the battery level indicator is not supported.)
Continuous operating time	Approx. 8.5 hours (when alkaline batteries are used, may vary depending on usage conditions)
Backup battery	Approx. 10 years (at 23°C)
Interface	USB, Bluetooth® (only for BT3554-01)
Dimensions	Approx. 199W × 132H × 60.6D mm (7.83"W × 5.20"H × 2.39"D) (protector attached)
Mass	BT3554: Approx. 937 g (33.1 oz.) (including batteries and protector) BT3554-01: Approx. 947 g (33.4 oz.) (including batteries and protector)
Product warranty period	3 years

General Specifications

Fuse	250 V / F 630 mAH (216.630, Littelfuse, Inc. product)
Accessories	p. 2
Options	p. 4 to p. 6
Display	LCD (monochrome, 182 segments)

8.2 Basic Specifications

Measurement items	<ul style="list-style-type: none"> • Measurement of battery internal resistance • Measurement of battery terminal voltage (DC voltage only) • Temperature measurement
Measurement range	<p>Resistance measurement: 0.000 mΩ to 3.100 Ω (4-range structure)</p> <p>Voltage measurement: 0.000 V to ±60.00 V (2-range structure)</p> <p>Temperature measurement: -10.0°C to 60.0°C (Single range structure)</p>
Maximum input voltage	60 V DC (between the positive and negative measurement terminals), does not accept AC voltage input.
Maximum rated voltage to earth	60 V DC (no measurement category) Anticipated transient overvoltage 330 V (between all measurement terminals and ground)
Measurement method	<p>Resistance measurement: AC 4-terminal method, open-circuit terminal voltage 5 V max.</p> <p>Measured current: 1.6 mA to 160 mA (Fixed according to the resistance measurement range)</p> <p>Temperature measurement: Platinum temperature sensor (500 Ω at 25°C)</p> <p>A/D conversion method: ΔΣ type</p> <p>Display update rate: 3 times/second (resistance, voltage, and temperature measured as a set)</p>
Error value display	<p>Constant current fault detection [----] display</p> <p>Disconnection detection [----] display</p> <p>Can be canceled by power-on option.</p>

Warning display	Input overflow: Both the [OVER] display and the maximum display value flash. In the event of an overvoltage input error, the red backlight lights up and the buzzer sounds.
Measurement terminals	<ul style="list-style-type: none">• Measurement terminals for Ω and V: Banana-plug type Maximum input voltage: ± 60 V DC max (does not accept AC voltage input) Input resistance: 20 kΩ or more• Temperature-measurement input terminal: Earphone-jack type ($\phi 3.5$ mm)• Switch input terminal: Earphone-jack type ($\phi 2.5$ mm)
Measurement time	100 ms
Response time	Approx. 1.6 second

8.3 Accuracy Specifications

Conditions of guaranteed accuracy	<p>Guaranteed accuracy period: 1 year</p> <p>Guaranteed accuracy period after adjustment made by Hioki: 1 year</p> <p>Temperature and humidity for guaranteed accuracy: 23°C±5°C (73°F±9°F), 80% RH or less</p> <p>Warm-up time: None (not required)</p>
Temperature characteristics	<p>Within the operating temperatures, multiply measurement accuracy by 0.1/°C and add.</p> <p>(Except between the range 18°C and 28°C)</p>
Resistance measurement accuracy	<p>Measured current accuracy: ±10%</p> <p>Measured current frequency: 1 kHz±30 Hz</p> <p>1 kHz±80 Hz if the noise frequency avoidance function is on.</p>

Range	Maximum value	Resolution	Measurement accuracy	Measured current
3 mΩ	3.100 mΩ	1 μΩ	±1.0% rdg.±8 dgt.*	160 mA
30 mΩ	31.00 mΩ	10 μΩ	±0.8% rdg.±6 dgt.	160 mA
300 mΩ	310.0 mΩ	100 μΩ		16 mA
3 Ω	3.100 Ω	1 mΩ		1.6 mA

* Add the following value if zero-adjustment has not been performed:

- When model L2020 is used: ±6 dgt.
- When model 9465-10 is used: ±5 dgt.
- When model 9772 is used: ±1 dgt.
- When model 9460 is used: ±16 dgt.
- When model 9467 is used: ±5 dgt.

When using test leads that are not listed above, or test leads whose length has been extended, accuracy is guaranteed only after zero-adjustment is performed.

Voltage measurement accuracy

Range	Maximum value	Resolution	Measurement accuracy
6 V	±6.000 V	1 mV	±0.08% rdg.±6 dgt.
60 V	±60.00 V	10 mV	

Temperature measurement accuracy

Individual accuracy under simulated input conditions:
±0.5°C (±0.9°F)

Unit conversion formula:

Fahrenheit [°F] = (9 ÷ 5) × Celsius [°C] + 32

Measuring range	Maximum value	Resolution	Measurement accuracy
-10°C to 60°C (14°F to 140°F)	60.0°C (140°F)	0.1°C (32.2°F)	±1.0°C (±1.8°F)

Effect of radiated radio-frequency electromagnetic field

At 3 V/m:

Resistance measurement: ±3.0% f.s,
voltage measurement: ±3.0% f.s

8.4 Functional Specifications

(1) Noise Frequency Avoidance function

Functionality	Noise frequencies are avoided with the noise reduction technology.
Default	OFF
How to set	<p>Power-on option</p> <p>Press and hold the Ω key while turning the power on in order to enter the setup mode.</p> <p>Select from either on or off and press the ENTER key to confirm the setting.</p> <p>(Turning the power on again as usual, turns the function off.)</p>

(2) Zero adjustment function

Functionality	The measurement values obtained when the function is performed (the correction values) are used as zero values.
Default	OFF
Correction range	Up to 300 counts for each resistance and voltage range
How to correct	<ul style="list-style-type: none"> • Press and hold the 0ADJ key for 2 seconds to enter the standby state. • The function obtains the correction values automatically after [-----] (for constant current fault detection or disconnection detection) is canceled. • All correction values for all ranges is obtained at once. • The function exits (is disabled) if [-----] is displayed for 10 seconds after it is started.
How to cancel	Press and hold the 0ADJ key for 2 seconds when the zero adjustment function is turned on, to cancel the function.

(3) Measurement-value Retaining function

Functionality	The function retains (suspends update of) displayed values.
How to set	<ul style="list-style-type: none"> • Press the HOLD key.*¹ • Input signals to the EXT.HOLD terminal.*² • Measurement values stabilizes (when the auto-hold function is on).
How to cancel	Perform either *1 or *2 above. (toggle action)

(4) Measurement-value Auto-hold function

Functionality	The function retains resistance measurement values automatically once they get stabilized.
Default	OFF
How to set	Use the A.HOLD/MEMO key to turn it on and off.

(5) Comparator function

Functionality	<p>Compares measurement values with setting values. How to judge: Based on the display results of the following table and buzzer sound.</p> <p>The red backlight turns on, along with the buzzer sounds when comparison results are WARNING or FAIL. (When the red backlight turns on, the white backlight turns off.)</p>
---------------	--

	Resistance (low)	Resistance (medium)	Resistance (high)
Voltage (high)	PASS	WARNING	FAIL
Voltage (low)	WARNING	WARNING	FAIL

Default	OFF
---------	-----

How to set	Press the COMP key to select the setting table to be used. Press and hold the COMP key to set the values for the resistance warning limit, resistance failure limit, and voltage warning limit.
How to cancel	Press the COMP key while the comparator function is on to cancel the function.
Max. settings	200 tables

(6) Memory function

Functionality	The function stores, reads out, and deletes measurement values.
Default	OFF
Data stored	Date and time, resistance value, voltage value, temperature value, comparator threshold value, results of judgment
Data count	6000
Memory structure	500 data sets per unit (12 units)
Unit name	A, B, C, D, E, F, G, H, J, L, N, and P

Storage	<p>Data is stored in the internal non-volatile ROM.</p> <ul style="list-style-type: none"> • Storing data in memory How to enable: Press the MEMO key while the memory function is off. How to cancel: Press and hold the MEMO key while the memory function is on. How to store data: <ol style="list-style-type: none"> 1. Select the memory number with the cursor keys. 2. Press the MEMO key to store the data while it is being retained. 3. Measurement values are stored when they are held if the auto-memory function is on. • Reading out data from the memory Press the READ key to read out, and select the memory number to be read out with the cursor keys. Application software can be used to read out the data. • Clearing the data from the memory Cycle through the clearing methods by pressing the CLEAR key. Single data → single unit → all data → single data → and so on.
---------	--

(7) Auto-memory function

Functionality	<p>The function automatically stores measurement values in memory when they are retained. The stored data can be cleared by the CLEAR key.</p>
Default	OFF
How to set	Use the A.HOLD/MEMO key to turn it on and off.





(8) Auto Power Save function

Functionality	The function automatically cuts off the power to the instrument when it has been inactive for 10 minutes or longer, and a constant current fault has been detected for 10 minutes or longer. The function is disabled while the computer application is sending and receiving data.
How to set	Power-on option Press the HOLD key while turning on the instrument to enter the setup mode. Select on or off and then press the ENTER key to apply the settings.





(9) Buzzer function

Functionality	The function sounds the buzzer based on the comparison result of the comparator.
Default	ON (The buzzer sounds if the comparison result is FAIL or WARNING.)
How to set	Use the  key to turn it on and off (3 options). OFF ON (The buzzer sounds if the comparison result is PASS.) ON (The buzzer sounds if the comparison result is FAIL or WARNING.)

(10) Battery Level Indicator function

Functionality	The function displays the battery level in 4 levels. The accuracy is guaranteed up to the time the indicator starts flashing (for alkaline batteries).
	 More than or equal to 10.1 V  9.2 V to 10.1 V  8.0 V to 9.2 V  (flashing) 7.6 V to 8.0 V (Power shutdown) Less than 7.6 V The calculation error is ± 0.2 V.

(11) Clock function

How to display	Press the DATE key to toggle between display and measurement screen.
How to set	Press and hold the DATE key to enter the setup mode. Use the   keys to select the item to set up. Use the   keys to change the value. Press the ENTER key to confirm the settings.
Function	24-hour clock; leap years are adjusted automatically.
Accuracy	Approximately 4 minutes/month
Default	No setup (00:00 on January 1, 2016) The setup screen appears the first time the function is started.
Other capabilities	Backup capability Built-in backup lithium battery life Approx. 10 years

(12) Backlight function

Functionality	 key to turn it on and off.
---------------	--

(13) Self Test function

LCD	All screen elements are displayed (power-on option).
ROM	Accessed and checked when the power is turned on.
Other capabilities	A/D converter, detection of hardware failure

(14) System Reset

Functionality	The function restores all the settings, excluding the comparator setup table and stored data, to factory defaults.
How to reset	<p>Power-on option</p> <ol style="list-style-type: none"> 1. Turn on the power while pressing the CLEAR key to navigate to the system reset screen. 2. Select [yES] or [no] and press the ENTER key to reset the system.

(15) USB Communication function

The function handles the commands to communicate with computers.

When the USB is connected to the computer while the Bluetooth®

Communication function is on, the Bluetooth® Communication function is turned off automatically. (only for BT3554-01).

(16) Bluetooth® Communication function (Only for BT3554-01)

The function enables you to transfer data to a smart phone or a tablet, and view measurement values.

8.5 Communication Specifications

USB

Data rate	USB2.0
Class	CDC
Connector	USB miniB

Bluetooth® (Only for BT3554-01)

Interface	Bluetooth® 4.0LE ( Bluetooth®)
Antenna power	Maximum +0 dBm (1 mW)
Communication distance	Approx. 10 m (line of sight)
Communication profile	GATT (Generic Attribute Profile)
Supported Android™ devices	Android™ 4.3 or later (Bluetooth® low energy enabled devices)
Supported iOS devices	iOS 10 or later (Bluetooth® low energy enabled devices)

9.1 Repair, Inspection, Cleaning

WARNING



Customers are not allowed to modify, disassemble, or repair the instrument. Doing so may cause fire, electric shock, or injury.

Calibrations

The calibration period varies depending on the status of the instrument or installation environment. We recommend that the calibration period be determined in accordance with the status of the instrument or installation environment. Please contact your authorized Hioki distributor or reseller to have your instrument periodically calibrated.

Precautions for Transportation

When transporting the instrument be sure to observe the following precautions:

- To avoid damage to the instrument, remove the batteries from the instrument. Moreover, be sure to pack in a double carton. Damage occurring during transportation is not covered by the warranty.
- When sending the instrument for repair, be sure to include details of the problem.

Cleaning

To clean the instrument, wipe it gently with a soft cloth moistened with water or mild detergent. Wipe the LCD gently with a soft, dry cloth. Never use solvents such as benzene, alcohol, acetone, ether, ketones, thinners or gasoline, as they can deform and discolor the instrument.

Replacement Parts and Operating Life

The characteristics of some of the parts used in the product may deteriorate with extended use. To ensure the product can be used over the long term, it is recommended to replace these parts on a periodic basis. When replacing parts, please contact your authorized Hioki distributor or reseller. The service life of parts varies with the operating environment and frequency of use. Parts are not guaranteed to operate throughout the recommended replacement cycle.

Part name	Recommended replacement cycle	Remarks and conditions
Backup battery	Approx. 10 years	Replace if the time and date are completely wrong when the instrument is turned on.

9.2 Troubleshooting

If damage is suspected, check the "Before Returning for Repair" section before contacting your authorized Hioki distributor or reseller.

Before Returning for Repair

If the instrument is not operating correctly, check the following:

Error	Cause	Solution
Nothing is displayed on the screen even after the  key is pressed.	The battery is drained.	Replace with new batteries. (p. 32)
	The batteries are inserted incorrectly.	Reinsert the batteries correctly. (p. 32)
Zero adjustment cannot be performed. [Err] is displayed on the screen.	The fuse is burned out.	Replace with a new fuse. (p. 109)
	When the model 9772 Pin Type Lead is used, the shorting method is incorrect.	Insert the side with the mark (engraved) into the holes on the zero adjustment board. (p. 41)
Pressing the Ω or V key has no effect.	The comparator function is turned on.	Use the COMP key to turn off the comparator function.
Pressing the MEMO key has no effect.	The data is not retained.	Use the HOLD key to retain the data.
Nothing is displayed on the screen even after the READ key is pressed.	This key cannot be used when no data has been stored.	-

Error	Cause	Solution
The comparison result of the comparator is not correct.	The comparator threshold values are not set correctly.	Set the correct threshold values. (p. 57)
Temperature is not displayed on the screen when the model 9460 Clip Type Lead with Temperature Sensor is used.	The model 9460 Clip Type Lead with Temperature Sensor is not connected correctly.	Connect it correctly. (p. 53)
Incorrect measurement values are obtained. or [----] is displayed on the screen. or Both [OVER] and the maximum display values flashes.	The test lead is not connected correctly.	Connect the test lead correctly. (p. 33)
	The test lead is disconnected.	Replace with a new test lead.
	The fuse is burned out.	Replace with a new fuse. (p. 109)
	Zero adjustment is not performed correctly.	Perform zero adjustment correctly. (p. 40)
	An appropriate range is not selected.	Select the appropriate range using the range key. (p. 39)
The date and time are completely wrong when the instrument is switched on.	The built-in backup lithium battery of the instrument needs replacement.	The user cannot replace the battery. Contact your authorized Hioki distributor or reseller.

9.3 Error Messages

If the screen displays an error, follow the table below to troubleshoot the error.

Message	Description	Solution
Err	Zero adjustment failed.	Connect the test lead correctly before performing zero adjustment. (p. 40)
	Noise frequency avoidance failed.	Connect the test lead correctly during the measurement.
no.AdJ	Adjustment data error	The instrument has to be repaired. Contact your authorized Hioki distributor or reseller.
Add.Err	A/D converter communication error	
Err01	Internal variable error	
Err02		
Err03		
Err04		
Err05		

If [----] is displayed and [OVER] flashes on the screen (at the same time, the maximum display values flashes), this does not indicate an error.

- [----] is displayed when input terminals have been opened.
- Both [OVER] and the maximum display value flash when the input values exceeds the set range. Set the range correctly.

9.4 Frequently Asked Questions

Question	Answer
<p>Can manganese batteries be used?</p>	<p>The continuous operating time of the instrument (approximately 8.5 hours) is measured using alkaline batteries. Note that use of manganese batteries considerably reduces the continuous operating time (approximately 2.5 hours: reference value).</p>
<p>Can Nickel Metal Hydride Batteries be used?</p>	<p>Can be used. However, the discharge characteristics of nickel-metal hydride batteries differ from those of alkaline batteries. Hence, there are significant errors in the battery level indicator when the nickel-metal hydride batteries are used.</p> <p>Due to those errors, note that there is a possibility of the instrument losing power suddenly under such conditions, regardless of the remaining battery life as shown by the battery level indicator.</p>
<p>Can the instrument measure internal resistance or voltage of battery up to how much ampere hour (Ah) ?</p>	<p>There is no limitation on the amount of current in ampere hours (Ah) because the instrument uses AC signals for measurement and DC current does not flow through the instrument.</p>
<p>What are the appropriate threshold values?</p>	<p>For more information, see “1.1 Measuring Battery Wear” (p. 19).</p>

9.5 Replacing the Fuse

When the fuse on the instrument is burned out, replace the fuse as described below.

- 1 **Switch off the instrument and remove the test leads.**

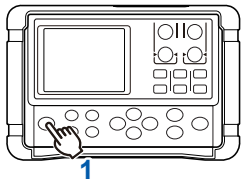

- 2 **Using a Phillips screwdriver, remove the fuse cover at the rear of the instrument.**

- 3 **Remove the burned-out fuse and replace it with a new one of the specified specifications.**

- 4 **Replace the fuse cover and tighten the screw.**

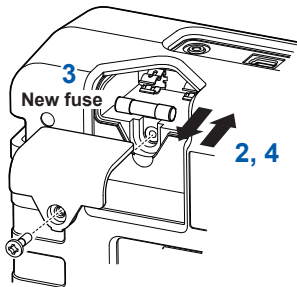

The fuses can be purchased via authorized Hioki distributor or reseller.

Fuse type: 216.630, Littelfuse Inc., fast-acting, rating 630 mA/250 V AC, circuit breaker rating 1500 A

9.6 Replacing the Test Lead's Tip Pin

The conductive-tip contact pin is replaceable. Replace the pin with a new one if it is broken or worn. One-piece conductive-tip contact pins with a plastic pin base (model 9465-90 Tip Pin) is available separately.

For model 9465-10

- 1 Turn off the instrument and remove the test lead.**
- 2 Unscrew the cable lock to unlock the cable.**

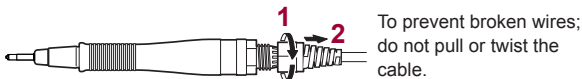

The cable is locked by screwing the cable lock.

- 3 Hold the tip pin base so that the cable won't rotate, and then rotate the grip to loosen it.**

1 Hold the tip pin base tightly.

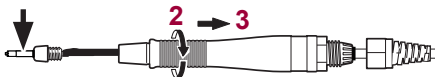

Beware of injury since the tip has a sharp point.

- 4 Pull off the connector and remove the tip pin.**

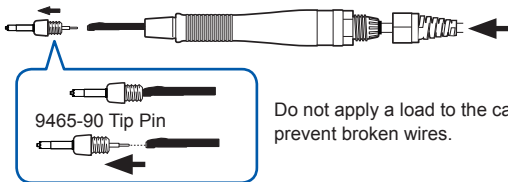

- 5** Fasten a new model 9465-90 Tip Pin. Press the tip of the pin against a hard board so that the pin won't spring out, and push the connector onto the pin.

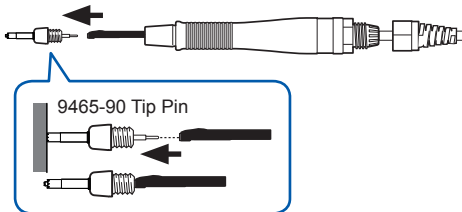

- 6** Assemble the tip pin in the reverse order of disassembling.

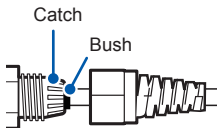

To prevent broken wires, fasten the bush approx. 1 mm higher than the catch. Be careful not to push the bush too deeply.

Do not pull or twist the cable.

- 7** To avoid broken wires and contact failures, after tightening the cable lock, gently tug and twist the cable to check that it is firmly held.

- 8** Check the performance.

Measure an object to make sure that the measured resistance is correct before using it.

For model L2020

1 Turn off the instrument and remove the test lead.

2 Rotate the grip to loosen it.

Beware of injury since the tip has a sharp point.

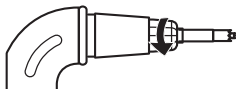

3 Remove the tip pin.

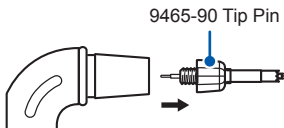

4 Replace with a new tip pin.

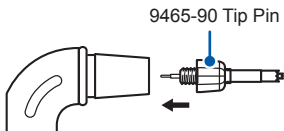

5 Rotate the grip to fasten it.

Be sure to fasten it tightly.

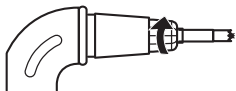

6 To avoid broken wires and contact failures, check that the cable is firmly held.

7 Check the performance.

Measure an object to make sure that the measured resistance is correct before using it.

9.7 Disposing the Instrument (Removing the Lithium Battery)

When disposing of this instrument, remove the lithium battery and dispose of battery and instrument in accordance with local regulations.

CALIFORNIA, USA ONLY

Perchlorate Material – special handling may apply.

See www.dtsc.ca.gov/hazardouswaste/perchlorate

- 1 Switch off the instrument and remove the test leads.

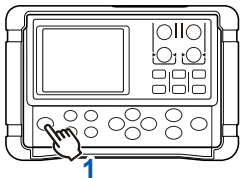

- 2 Remove the protector.
- 3 Remove the 4 screws at the rear of the instrument using a Phillips screwdriver.

- 4 Remove the cable protruding from the battery holder.

- 5 Remove the upper panel.

- 6 Using tweezers or a similar tool, remove the lithium battery from the lower panel.

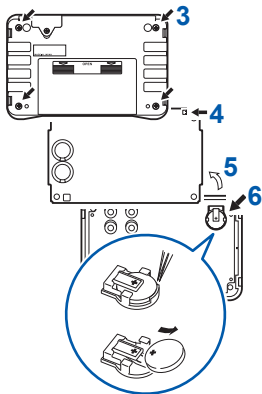

Appendix

Appx. 1 Effect of Extending the Test Lead and Induced Voltage

A special order has to be placed for extending the test lead. Contact your authorized Hioki distributor or reseller. Users must not extend the test leads by themselves.

Reducing Induced Voltage

The instrument is affected by the induced voltage as it measures minute resistance with AC power. The induced voltage refers to a voltage that allows the current generated in the instrument to build an inductive coupling in a lead and affect the signaling system.

Because the phase of the induced voltage is shifted from that of the AC current (reference signal) by 90 degrees, it can be eliminated with a synchronous detection if the voltage is low. But for high levels, the induced voltage distorts the signals, causing incorrect synchronous detection. Since the induced voltage increases with the length of the test leads, the key to reducing the induced voltage is to shorten the test leads. Reducing the length of the branched section is particularly effective.

Even when using the standard test lead, if the lead arrangement differs significantly between zero adjustment and when measurements are taken in the 3 m Ω range, the effects of the induced voltage causes the measurement values to fluctuate by approximately 15 dgt.

Appx. 2 Effect of Eddy Currents

The AC current generated in the instrument induces eddy currents in the surrounding metallic plates, which generate induced voltage in the test lead. The phase of this induced voltage is shifted by 180 degrees from the AC current (reference signal), hence it cannot be eliminated by the synchronous detection, resulting in measurement errors.

The influence of eddy currents is a phenomenon unique to ohmmeters that measure resistance using an AC source. To protect the test lead from such effects, keep metallic parts, including metallic plates, at a suitable distance from the test lead (branched section).

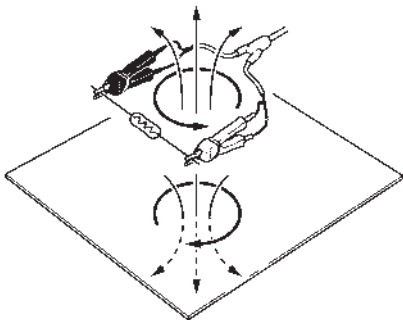

Appx. 3 AC 4-terminal Measurement Method

The instrument uses the AC 4-terminal method, so that it can measure resistance by canceling the resistance of the leads and the contact resistance between the leads and the measurement target. The following figure shows the principle of the AC 4-terminal measurement method.

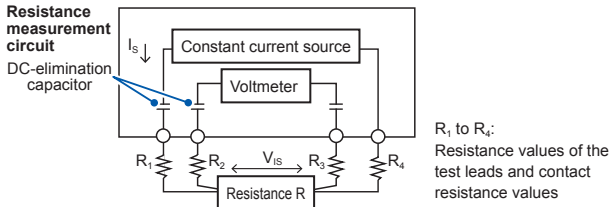

The AC current I_s is applied to the measurement target from the instrument's SOURCE terminals. The voltage drop, V_{is} , due to the internal impedance of the measurement target is measured at the SENSE terminals. The SENSE terminals are connected to an internal voltmeter with a high impedance. Hence the current flowing through the resistances R_2 and R_3 , which represent the lead resistances and contact resistance, is almost zero. As a result, the voltage drop across the resistances R_2 and R_3 is almost zero. Thus, the voltage drop due to the resistances R_2 and R_3 is canceled out. In the instrument, a synchronized wave detection is used, whereby the internal impedance of the measurement target is separated into effective resistance and reactance, and only the effective resistance is displayed. If one of the following resistances increases, the instrument can no longer supply normal current to the measured object:

- Lead resistance
- Contact resistance between the measured object and the lead
- Contact resistance between the lead and the instrument

AC 4-terminal Measurement Method

The above cases results in an measurement error status, and the resistance is indicated by [-----]. For more information on measurement errors, see "Error Measurements" (p. 52).

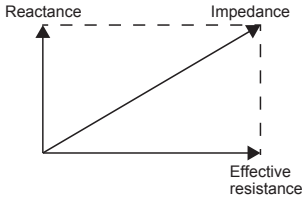

Appx. 4 Effects of Current Density

When the Measurement target is Wide or Thick

When the measurement target is wide or thick, such as a plate or block, performing accurate measurements is difficult when clip type or pin type leads are used. In such cases, a difference in the contact pressure or contact angle could lead to variations in measurement values from a few to a few-dozen percent. For example, when the measurement object is a metal sheet with dimensions of $W300 \times L370 \times t0.4$, measurement values taken from the same location may differ markedly as shown below:

0.2 mm-pitch pin type lead: 1.1 m Ω

0.5 mm-pitch pin type lead: 0.92 m Ω to 0.97 m Ω

9287-10 Clip Type Lead: 0.85 m Ω to 0.95 m Ω

This is caused by the current distribution in the measurement target, not by the contact resistance between the probe and the measurement target. Figure 1 shows an example of plotted equipotential lines on a metal plate. Just like the relationship between wind and the barometric charts used in weather forecasts, current density is higher where the equipotential lines are close to each other and lower where the lines are farther apart. This figure shows that the potential gradient is greater near the sources of current. This is because these points are in the middle from where the electric current is spreading across the metal plate, leading to a higher current density. For this reason, when a terminal for detecting voltage is placed near one of these sources of current, just the slightest change in contact position can lead to major variation in measurement values.

Use of Hioki's model 9453 Four Terminal Lead or a similar lead to detect voltage on the inner side of the sources of current is necessary to avoid these effects. In other words, the current distribution is likely to be stable if measurement is conducted within the width (W) or thickness (t) of the measurement target.

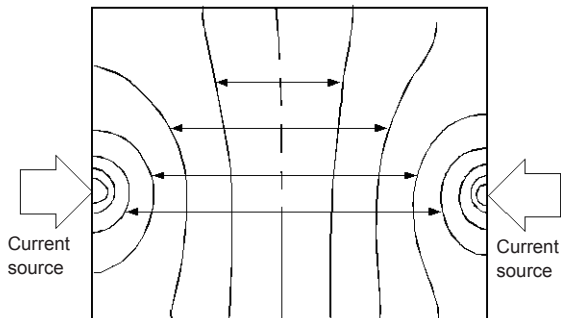

Figure 1: A plot of the equipotential lines on a metal plate, showing the current distribution at 50 μV intervals when a 1 A current is applied at the endpoints of the plate ($W300 \times L370 \times t0.4$)

As shown in Figure 2, it is preferable to locate the SENSE terminals within the plate's W or t value of the SOURCE terminals:

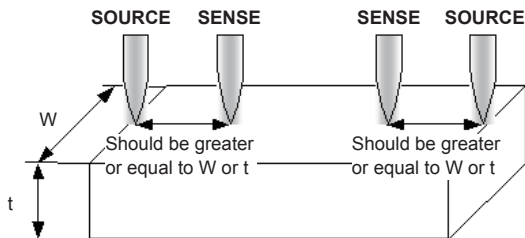

Figure 2: Probing locations when the measurement target is wide or thick

IMPORTANT

Keeping track of changes over time is important to determine if a battery has deteriorated. Hence, use the same test leads when measuring.

Appx. 5 Synchronous Detection System

The figure below shows an equivalent circuit for a battery. If the measurement target exhibits other electrical characteristics in addition to pure resistance, as shown in this figure, the synchronous detection system can be used to obtain the effective resistance of the measurement target. The synchronous detection system is also used to separate faint signals from noise.

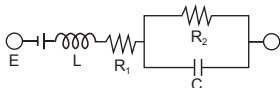

The synchronous detection system picks up the reference signal and those signals having the same phase components. The figure below gives a simplified schematic diagram of the synchronous detection system. The system consists of a multiplying circuit that multiplies 2 signals and a low-pass filter (LPF) that picks up only DC components from the output.

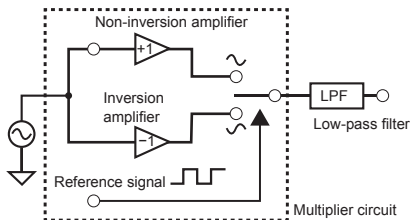

If "v1" is considered a reference signal voltage for the AC current generated in the instrument, and "v2" as the signal voltage for use in synchronous detection, these parameters may be expressed by the equation given below. θ of v2 shows the phase difference with respect to v1 generated by the reactance.

$$v_1 = A \sin \omega t$$

$$v_2 = B \sin (\omega t + \theta)$$

When synchronous detection is applied to both v1 and v2, they are expressed as follows:

$$v_1 \times v_2 = 1/2AB \cos \theta - 1/2AB \cos (2\omega t + \theta)$$

The first term indicates the voltage drop due to the effective resistance. The second term is attenuated by the LPF. The instrument displays the first term.

Appx. 6 Calibration

⚠ CAUTION



To prevent damage to the instrument, do not apply a voltage between the positive (+) SOURCE and SENSE terminals or between the negative (-) SOURCE and SENSE terminals. Also, do not conduct measurements when the instrument is turned off.

For the calibration environment, see the conditions of guaranteed accuracy (p. 93) in the Specifications chapter.

Calibrating the Resistance Measurement Component

- Use a standard resistor with little aging and with good temperature performance.
- Use a resistor with 4 terminals to prevent effects due to the resistor leads.
- Be sure to assign resistor values in 1 kHz AC for the instrument. Using a coil resistor will result in a higher inductance component. For this reason, pure (DC) resistance will not equal effective resistance (the real part of impedance; displayed on the instrument).
- Connect the instrument to the standard resistor as shown below:

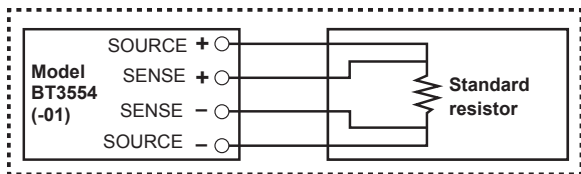

Calibrating the Voltage Measurement Unit

- Use a generator that can output a DC voltage of 60 V.
- Connect the instrument to the generator as shown below:

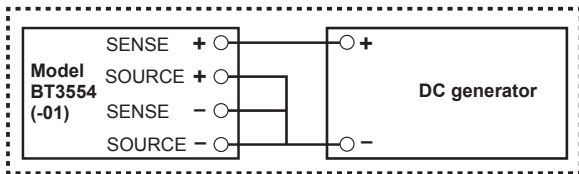

- Do not apply AC current from the instrument to the generator, which may cause the generator to malfunction.
- Use a low-output-impedance (50 Ω or less) generator.
- If [----] is displayed, the disconnection detection function of the instrument needs to be canceled.

Canceling the Disconnection Detection function

- 1** Turn off the instrument.
- 2** Press and hold the **A HOLD/MEMO** key while turning on the power.
[on] flashes.
- 3** Using the cursor keys, change the [on] to [oFF].
- 4** Press the **ENTER** key.
This turns off the disconnection detection function and restarts the instrument.

Restart the instrument after calibration. The disconnection detection function will be turned on again. Do not cancel the disconnection detection function during normal measurement.

Warranty Certificate

HIOKI

Model	Serial number	Warranty period
		Three (3) years from date of purchase (___ / ___)

Customer name: _____

Customer address: _____

Important

- Please retain this warranty certificate, Duplicates cannot be reissued,
- Complete the certificate with the model number, serial number, and date of purchase, along with your name and address. The personal information you provide on this form will only be used to provide repair service and information about Hioki products and services.

This document certifies that the product has been inspected and verified to conform to Hioki's standards. Please contact the place of purchase in the event of a malfunction and provide this document, in which case Hioki will repair or replace the product subject to the warranty terms described below.

Warranty terms

1. The product is guaranteed to operate properly during the warranty period (three [3] years from the date of purchase).
If the date of purchase is unknown, the warranty period is defined as three (3) years from the date (month and year) of manufacture (as indicated by the first four digits of the serial number in YYMM format).
2. If the product came with an AC adapter, the adapter is warranted for one (1) year from the date of purchase.
3. The accuracy of measured values and other data generated by the product is guaranteed as described in the product specifications.
4. In the event that the product or AC adapter malfunctions during its respective warranty period due to a defect of workmanship or materials, Hioki will repair or replace the product or AC adapter free of charge.
5. The following malfunctions and issues are not covered by the warranty and as such are not subject to free repair or replacement:
 - 1. Malfunctions or damage of consumables, parts with a defined service life, etc.
 - 2. Malfunctions or damage of connectors, cables, etc.
 - 3. Malfunctions or damage caused by shipment, dropping, relocation, etc., after purchase of the product
 - 4. Malfunctions or damage caused by inappropriate handling that violates information found in the instruction manual or on precautionary labeling on the product itself
 - 5. Malfunctions or damage caused by a failure to perform maintenance or inspections as required by law or recommended in the instruction manual
 - 6. Malfunctions or damage caused by fire, storms or flooding, earthquakes, lightning, power anomalies (involving voltage, frequency, etc.), war or unrest, contamination with radiation, or other acts of God
 - 7. Damage that is limited to the product's appearance (cosmetic blemishes, deformation of enclosure shape, fading of color, etc.)
 - 8. Other malfunctions or damage for which Hioki is not responsible
6. The warranty will be considered invalidated in the following circumstances, in which case Hioki will be unable to perform service such as repair or calibration:
 - 1. If the product has been repaired or modified by a company, entity, or individual other than Hioki
 - 2. If the product has been embedded in another piece of equipment for use in a special application (aerospace, nuclear power, medical use, vehicle control, etc.) without Hioki's having received prior notice
7. If you experience a loss caused by use of the product and Hioki determines that it is responsible for the underlying issue, Hioki will provide compensation in an amount not to exceed the purchase price, with the following exceptions:
 - 1. Secondary damage arising from damage to a measured device or component that was caused by use of the product
 - 2. Damage arising from measurement results provided by the product
 - 3. Damage to a device other than the product that was sustained when connecting the device to the product (including via network connections)
8. Hioki reserves the right to decline to perform repair, calibration, or other service for products for which a certain amount of time has passed since their manufacture, products whose parts have been discontinued, and products that cannot be repaired due to unforeseen circumstances.

HIOKI E.E. CORPORATION

<http://www.hioki.com>

18-07 EN-3

HIOKI

<http://www.hioki.com>



**Our regional
contact
information**

HEADQUARTERS

81 Koizumi
Ueda, Nagano 386-1192 Japan

HIOKI EUROPE GmbH

Rudolf-Diesel-Strasse 5
65760 Eschborn, Germany
hioki@hioki.eu

1808EN

Edited and published by HIOKI E.E. CORPORATION

Printed in Japan

- CE declarations of conformity can be downloaded from our website.
- Contents subject to change without notice.
- This document contains copyrighted content.
- It is prohibited to copy, reproduce, or modify the content of this document without permission.
- Company names, product names, etc. mentioned in this document are trademarks or registered trademarks of their respective companies.