

GasAlert **MaxXT II**

1, 2, 3, and 4-Gas Detector

Technical Reference Guide

BW
Technologies
by Honeywell

Limited Warranty and Limitation Liability

BW Technologies LP (BW) warrants the product to be free from defects in material and workmanship under normal use and service for a period of two years, beginning on the date of shipment to the buyer. This warranty extends only to the sale of new and unused products to the original buyer. BW's warranty obligation is limited, at BW's option, to refund of the purchase price, repair or replacement of a defective product that is returned to a BW authorized service center within the warranty period. In no event shall BW's liability hereunder exceed the purchase price actually paid by the buyer for the Product.

This warranty does not include:

- a) fuses, disposable batteries or the routine replacement of parts due to the normal wear and tear of the product arising from use;
- b) any product which in BW's opinion, has been misused, altered, neglected or damaged, by accident or abnormal conditions of operation, handling or use;
- c) any damage or defects attributable to repair of the product by any person other than an authorized dealer, or the installation of unapproved parts on the product; or

The obligations set forth in this warranty are conditional on:

- a) proper storage, installation, calibration, use, maintenance and compliance with the product manual instructions and any other applicable recommendations of BW;
- b) the buyer promptly notifying BW of any defect and, if required, promptly making the product available for correction. No goods shall be returned to BW until receipt by the buyer of shipping instructions from BW; and
- c) the right of BW to require that the buyer provide proof of purchase such as the original invoice, bill of sale or packing slip to establish that the product is within the warranty period.

THE BUYER AGREES THAT THIS WARRANTY IS THE BUYER'S SOLE AND EXCLUSIVE REMEDY AND IS IN LIEU OF ALL OTHER WARRANTIES, EXPRESS OR IMPLIED, INCLUDING BUT NOT LIMITED TO ANY IMPLIED WARRANTY OF MERCHANTABILITY OR FITNESS FOR A PARTICULAR PURPOSE. BW SHALL NOT BE LIABLE FOR ANY SPECIAL, INDIRECT, INCIDENTAL, OR BASED ON CONTRACT, TORT OR RELIANCE OR ANY OTHER THEORY.

Since some countries or states do not allow limitation of the term of an implied warranty, or exclusion or limitation of incidental or consequential damages, the limitations and exclusions of this warranty may not apply to every buyer. If any provision of this warranty is held invalid or unenforceable by a court of competent jurisdiction, such holding will not affect the validity or enforceability of any other provision.

BW Technologies by Honeywell
Corporate Headquarters
2840 - 2nd Ave. SE
Calgary, AB
Canada T2A 7X9

BW Technologies by Honeywell
America
3279 West Pioneer Parkway
Arlington, TX
USA 76013

BW Technologies by Honeywell
Europe
5 Canada Close
Banbury, Oxfordshire
United Kingdom OX16 2RT

Table of Contents

Title	Page
Contacting BW Technologies by Honeywell	1
Introduction	1
Gases Monitored	2
Safety Information - Read First	2
Getting Started	6
Parts of the GasAlertMax XT II	7
Display Elements	8
Activating/Deactivating the Detector	10
Startup Tests	10
Battery Test	10
Audible/Visual Test	10
Firmware Version	11
Startup Message	11
Location Logging	11
Pump Test on Startup.....	12
Alarm Setpoints	13
Self-Test	14
Automatic Zero for H ₂ S, CO, O ₂ , and LEL	15
If Previous Calibration Failed	15
Calibration Due Date (optional)	16
Force Calibration Enabled (optional)	16
Cal IR Lock Enabled (optional)	17
If Previous Bump Failed.....	17

GasAlertMax XT II

Technical Reference Guide

Title	Page
Bump Test.....	17
Force Bump Enabled (optional)	18
Startup Test Pass	18
Startup Test Fail.....	19
Installing Fleet Manager II	20
Using Fleet Manager II to Configure the Detector	20
Device Configuration	21
Serial Number Field	22
Firmware Version.....	22
Hardware Version	22
Startup Message Top Line.....	22
Startup Message Bottom Line.....	22
Lockout on Self-Test Error (failed sensor lock).....	22
Safe Mode.....	23
Confidence Beep	23
Latching Alarms	23
Force Calibration.....	23
Force Bump	24
Cal IR Lock	24
Location Logging.....	25
Force Block Test.....	25
Datalog Interval.....	25
Confidence Interval	26
Language.....	26
Sensor Configuration	26
Sensor Disabled.....	27
Calibration Gas (ppm).....	27

Title	Page
Calibration Interval	28
Bump Interval	28
Low Alarm	28
High Alarm	28
TWA Alarm.....	29
STEL Alarm.....	29
STEL Interval	30
TWA Period (hours)	30
Correction Factor (%).....	30
50% LEL = (%CH ₄).....	31
Auto Zero on Startup.....	31
LEL by Volume CH ₄	31
10% (of reading) Over-span.....	31
20.8 Base Reading	31
Low Alarm Acknowledge.....	31
Alarms	32
Computed Gas Exposures	35
Viewing and Clearing Gas Exposures	35
Gas Alarm Setpoints	36
Resetting Gas Alarm Setpoints	37
Stopping a Gas Alarm	37
Sensor Alarm	37
Pump Alarm	38
Low Battery Alarm.....	38
Automatic Deactivation Alarm	38
Bump Test.....	39
Bump Test Using the MicroDock II Station	39

Title	Page
Calibration	40
Guidelines	40
Diagnostics Protection	41
Connecting the Gas Cylinder to the Detector	41
Calibration Procedure	42
Auto Zero Sensor	43
Auto Span	44
Calibration Due Date	45
Verification	46
Calibrating Using the IR Link	47
Event Logs	49
Datalogs	49
Bump and Calibration Results	50
Downloading Datalogs and Event Logs	50
Software Requirements	50
Maintenance	51
Maximum Hose Length for Sampling	51
Battery Maintenance and Cautions	51
Charging the Battery	52
Optimum Battery Operation	53
Replacing the Battery	53
Replacing a Sensor or Sensor Filter	53
Replacing the Pump Filters	57
Replacing the Pump	59
Troubleshooting	60
Replacement Parts and Accessories	63
Specifications	65

Title	Page
General Datalogger Specifications	67

List of Figures

Figure	Title	Page
1.	Parts of the GasAlertMax XT II.....	7
2.	Display Elements.....	8
3.	Connecting the IR Link.....	20
4.	Device Configuration Section.....	21
5.	Sensor Configuration Tab (H ₂ S).....	26
6.	Connecting the Gas Cylinder to the Detector.....	42
7.	Calibrate Device Dialog Box.....	47
8.	Connecting the Charger Adapter.....	52
9.	Replacing a Sensor or Sensor Filter.....	55
10.	Front and Rear Shells Side by Side.....	56
11.	Remove the O ₂ Sensor With a Scredriver.....	56
12.	Replacing the Pump Filters.....	58
13.	Removing the Pump Filters.....	58
14.	Troubleshooting.....	60

List of Tables

Table	Title	Page
1.	Gases Monitored	2
2.	International Symbols	5
3.	Parts of the GasAlertMax XT II.....	7
4.	Display Elements.....	8
5.	Pushbutton	9
6.	Connecting the IR Link	20
7.	Alarms	32
8.	Computed Gas Exposures	35
9.	Gas Alarm Setpoints	36
10.	Sample Factory Alarm Setpoints.....	37
11.	Connecting the Charger Adapter.....	52
12.	Replacing a Sensor or Sensor Filter	54
13.	Replacing the Pump Filters	57
14.	Replacement Parts and Accessories	63

GasAlertMax XT II

Contacting BW Technologies by Honeywell

To contact BW Technologies by Honeywell, call

USA: 1-888-749-8878

Canada: 1-800-663-4164

Europe: +44 (0) 1295 700300

Other countries: +1-403-248-9226

Address correspondence to

BW Technologies by Honeywell

2840 – 2 Avenue S.E.

Calgary, AB T2A 7X9

CANADA

Email us at: info@gasmonitors.com

Visit BW Technologies by Honeywell's website at:

www.gasmonitors.com

ISO 9001

Introduction

Warning

To ensure personal safety, read [Safety Information - Read First](#) and [Cautions](#) before using the detector.

The GasAlertMax XT II gas detector ("the detector") warns of hazardous gas at levels above user-defined alarm setpoints.

The detector is a personal safety device. It is your responsibility to respond properly to the alarm.

Gases Monitored

The following table lists the gases that are monitored by the detector.

Table 1. Gases Monitored

Gas Detected	Unit of Measure
Hydrogen sulfide (H ₂ S)	parts per million (ppm)
Carbon monoxide	parts per million (ppm)
Combustible gases (LEL)	a) percent of lower explosive limit (%LEL) b) percent by volume methane 0-5.0% v/v
Oxygen (O ₂)	% volume

CAUTION: FOR SAFETY REASONS, THIS EQUIPMENT MUST BE OPERATED AND SERVICED BY QUALIFIED PERSONNEL ONLY. READ AND UNDERSTAND THIS TECHNICAL REFERENCE GUIDE COMPLETELY BEFORE OPERATING AND SERVICING.

Safety Information - Read First

Use the detector only as specified in this technical reference guide, otherwise the protection provided by the detector may be impaired.

International symbols used on the detector and in this technical reference guide are defined in [Table 2](#).

Read the [⚠ Cautions](#) on the following pages before using the detector.

Warning

This instrument contains a lithium polymer battery. Dispose of lithium cells immediately. Do not disassemble and do not dispose of in fire. Do not mix with the solid waste stream. Spent batteries must be disposed of by a qualified recycler or hazardous materials handler.

⚠ Cautions

- **Warning:** Substitution of components may impair Intrinsic Safety.
- **Caution:** For safety reasons, this equipment must be operated and serviced by qualified personnel only. Read and understand the technical reference guide completely before operating or servicing.
- Do not use the detector if it is damaged. Inspect the detector before using. Look for cracks and/or missing parts.
- If the detector is damaged or parts are missing, contact [BW Technologies by Honeywell](#) immediately.
- Use only sensor(s) that are specifically designed for the GasAlertMax XT II model. Refer to [Replacement Parts and Accessories](#).
- Calibrate the detector before first-time use and then on a regular schedule, depending on use and sensor exposure to poisons and contaminants. Sensors must be calibrated regularly and at least once every 180 days (6 months).
- BW recommends to bump test the sensors, before each day's use, to confirm their ability to respond to gas by exposing the detector to a gas concentration that exceeds the alarm setpoints. Manually verify that the audible and visual alarms are activated. Calibrate if the readings are not within the specified limits.
- Protect the combustible sensor from exposure to lead compounds, silicones, and chlorinated hydrocarbons. Although certain organic vapors (such as leaded gasoline and halogenated hydrocarbons) may temporarily inhibit sensor performance, in most cases, the sensor will recover after calibration.
- BW recommends the combustible sensor be checked with a known concentration of calibration gas after any known exposure to catalyst contaminants/poisons (sulfur compounds, silicon vapors, halogenated compounds, etc).
- The combustible sensor is factory calibrated to 50% LEL methane. If monitoring a different combustible gas in the % LEL range, calibrate the sensor using the appropriate gas.
- **Warning:** High off-scale LEL readings may indicate an explosive concentration.
- Only the combustible gas detection portion of this instrument has been assessed for performance by CSA International.
- For use only in potentially explosive atmospheres where oxygen concentrations do not exceed 20.9% (v/v).
- Any rapid up-scaling reading followed by a declining or erratic reading may indicate a gas concentration beyond upper scale limit, which may be hazardous.
- Calibrate only in a safe area that is free of hazardous gas.



⚠ Cautions

- Use only BW approved batteries for the GasAlertMax XT II detector. Refer to [Replacement Parts and Accessories](#).
- Charge the detector before first-time use. BW recommends the detector be charged after every workday.
- Charge the GasAlertMax XT II using the recommended charging adapter only. Do not use any other charging adapter. Failure to adhere to this precaution can lead to fire and/or explosion. Read and adhere to all instructions in the charger operator's manual. Failure to do so can result in fire, electrical shock, personal injury, and/or property damage.
- Extended exposure of the GasAlertMax XT II to certain concentrations of combustible gases and air may stress a detector element, which can seriously affect its performance. If an alarm occurs due to high concentration of combustible gases, recalibration should be performed, or if needed, the sensor replaced.
- Do not test the combustible sensor's response with a butane cigarette lighter; doing so will damage the sensor.
- Do not expose the detector to electrical shock or severe continuous mechanical shock.
- Do not immerse the detector in liquids.
- The pump (XT-RPUMP-K1) is certified for use with the GasAlertMax XT II detector only.
- Do not attempt to disassemble, adjust, or service the detector unless instructions for that procedure are provided in the technical reference guide and/or that part is listed as a replacement part. Use only BW Technologies by Honeywell [Replacement Parts and Accessories](#).
- The detector warranty will be voided if customer, personnel, or third parties damage the detector during repair attempts. Non-BW Technologies by Honeywell repair/service attempts void this warranty.
- **Warning:** The lithium battery (MX-BAT01) may present a risk of fire or chemical burn hazard if misused. Do not disassemble, heat above 212°F (100°C), or incinerate.
- Do not use any other lithium batteries with the GasAlertMax XT II detector. Use of any other cell can cause fire and/or explosion. To order and replace the MX-BAT01 battery, refer to [Replacement Parts and Accessories](#).

⚠ Cautions

- **Warning:** Lithium polymer cells exposed to heat at 266°F (130°C) for 10 minutes can cause fire and/or explosion.
- **Dispose of used lithium cells immediately. Do not disassemble and do not dispose of in fire. Do not mix with the solid waste stream. Spent batteries must be disposed of by a qualified recycler or hazardous materials handler.**
- **Keep lithium cells away from children.**
- **Calibration cylinders that are used with a demand flow regulator must meet the following maximum inlet pressure specifications:**
 - **Disposable cylinders 0-3000 psig/70 bar**
 - **Refillable cylinders 0-3000 psig/70 bar**

Table 2. International Symbols

Symbol	Meaning
	Approved to both U.S. and Canadian Standards by CSA International
	European Explosives Protection
CE	Conforms to European Union Directives
ATEX	Conforms to European ATEX Directives
IECEx	International Electrotechnical Commission Scheme for Certification to Standards for Electrical Equipment for Explosive Atmospheres

Getting Started

The list below provides the standard items included with the detector. If the detector is damaged or parts are missing, contact the place of purchase immediately.

- Sensors: H₂S, CO, O₂, and combustible (LEL)
- Calibration hose with quick connector
- Charging adapter
- Operator's manual
- Quick reference card
- Technical reference guide on CD-ROM

Note

The IR connectivity kit, which includes the IR Link, is sold separately.

To order parts, refer to [Replacement Parts and Accessories](#).

The detector is shipped with the sensors, pump, and rechargeable battery installed. To replace sensors, the pump, or the battery, refer to [Replacement Parts and Accessories](#).

For instructions to replace the sensor(s), pump, or battery, refer to the procedures in the following sections:

- [Replacement Parts and Accessories](#)
- [Replacing the Pump](#)
- [Replacing the Battery](#)

To become oriented with the features and functions of the detector, refer to the following figures and tables:

- [Figure 1](#), and [Table 3](#), describe the detector's components.
- [Figure 2](#), and [Table 4](#), describe the detector's display elements.
- [Table 5](#), describes the detector's pushbutton.

Parts of the GasAlertMax XT II

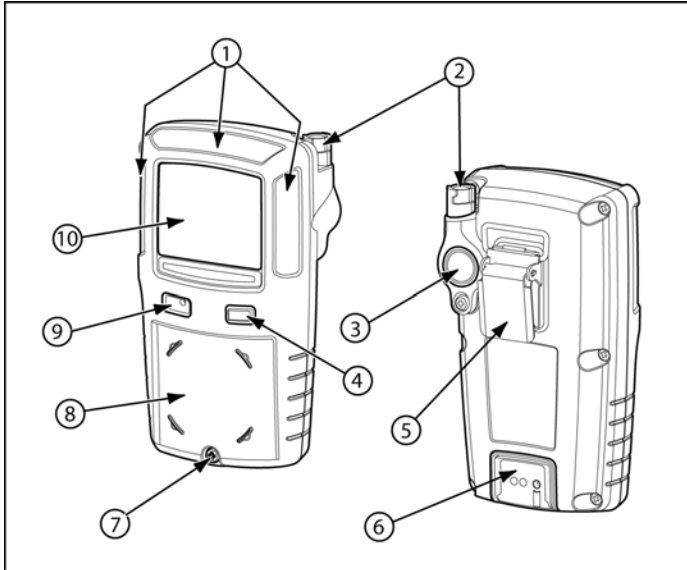

Figure 1. Parts of the GasAlertMax XT II

Table 3. Parts of the GasAlertMax XT II

Item	Description
1	Visual alarm indicators (LEDs)
2	Pump quick connector
3	Pump filter and moisture filter
4	Pushbutton
5	Alligator clip
6	Charging connector and IR interface
7	Diffusion cover locking screw
8	Diffusion cover
9	Audible alarm
10	Liquid crystal display (LCD)

Display Elements

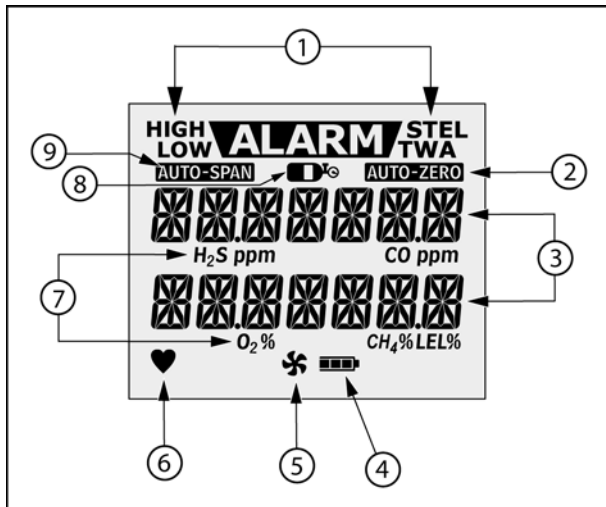



Figure 2. Display Elements

Table 4. Display Elements

Item	Description
1	Alarm condition
2	Automatically zero sensor indicator
3	Numeric values
4	Battery life indicator
5	Pump indicator
6	Heartbeat indicator
7	Gas type identifiers
8	Gas cylinder indicator
9	Automatically span sensor indicator

Table 5. Pushbutton

Pushbutton	Description
	<ul style="list-style-type: none"> • To activate the detector press ○. • To deactivate the detector, press and hold ○ until the OFF countdown is complete and the LCD deactivates. • To view the date/time, TWA, STEL, and maximum (MAX) readings, press ○ twice rapidly. To clear the TWA, STEL, and MAX readings, press ○ when the LCD displays CLEAR ALL. • To initiate calibration, press and hold ○ as the detector performs the OFF countdown. Continue holding ○ while the LCD briefly deactivates and then reactivates to begin the CAL countdown. Release ○ when the CAL countdown is complete. • To activate the backlight, press ○ and release. • To acknowledge the latched and pump alarms, press ○. • To acknowledge a low alarm and disable the audible alarm temporarily, press ○. The Low Alarm Acknowledge option must be enabled in Fleet Manager II. • To acknowledge any of the Due Today alarms (calibration, bump test, pump block test), press ○.

Activating/Deactivating the Detector

Note

Ensure the diffusion cover is attached prior to activating the detector to verify the pump is working correctly.

To activate the detector, press  in a safe area that is free of hazardous gas. Attach any pump accessories to the detector prior to activating the detector.

To deactivate the detector, press and hold  until the **OFF** countdown completes.

Caution

The maximum hose length for sampling is 75 ft (22m).

Startup Tests

When the detector is activated, it performs several startup tests. Confirm the following tests occur.

Battery Test

The detector performs a battery test during startup. If the battery has insufficient power to operate, the following screens displays before deactivating.



Recharge the battery for 6 hours and then reactivate the detector. Refer to [Charging the Battery](#).

Audible/Visual Test

1. All of the LCD elements display simultaneously as the detector beeps, flashes, vibrates, and activates the backlight.



Firmware Version

2. The current firmware version installed on the detector displays on the LCD.



Startup Message

3. If enabled and data is entered in Fleet Manager II, a startup message (25 characters per line) displays or scrolls (depending upon length of message) on the LCD. If the startup message option is not enabled, it is bypassed during the startup test.

Refer to [Startup Message Top Line](#) in User Options.

Location Logging

4. If the **Location Logging** option is enabled, the detector prompts for a number (**1-999**) to be entered that identifies the location (wells, plants, or other areas) where the detector is being used.



Within 3 seconds, press and continue pressing until the desired number displays. To scroll rapidly, press and hold .

Note

The site ID number that is entered does not reset when the detector is deactivated. If required, enter a new site ID when the detector is again activated.

Pump Test on Startup

Note

The diffusion cover must be attached to the detector to activate the pump and initiate the pump test.

⚠ Caution

The maximum hose length for sampling is 75 ft (22m).

5. In cold temperatures, the pump may require a short period of time to warm up before operating. If this is required, the following screen displays.



The LCD displays a countdown of the time remaining (in seconds) for the pump to warm up.

If the **Force Block Test** option is enabled, the detector performs a pump test. The following screen displays.



Using your finger, block the end of the hose. The following screen displays.



Note

If the hose is not blocked and unblocked within 2.5 minutes, the detector will assume the pump has failed and deactivates.

Successful Pump Test: If the pump test is successful, the following screen displays.



Unsuccessful Block Pump Test: If the pump is not operating correctly, the following screens display before the detector deactivates.





Activate the detector again. If the pump fails the startup again, refer to [Troubleshooting](#).

If the diffusion cover is not attached, the detector beeps and the following screen displays before continuing with the startup tests.

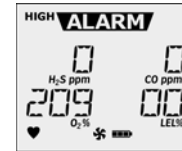

When the diffusion cover is replaced, the detector activates the pump alarm.



HIGH displays, and **ALARM** and  flashes. Press  to acknowledge the alarm and initiate the pump block test.

Alarm Setpoints

Note

Alarm setpoints vary by region. Refer to [Resetting Gas Alarm Setpoints](#).

- If the CO and/or H₂S sensor is enabled, the alarm setpoints for the time-weighted average (TWA) and the short-term exposure limit (STEL) display.

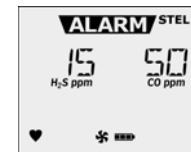
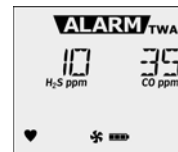

GasAlertMax XT II

Technical Reference Guide

Next, the **LOW** and **HIGH** alarm setpoints display for all of the enabled sensors.

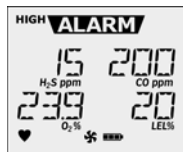
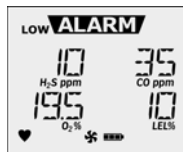

Self-Test

7. The detector then performs a self-test to ensure it is operating correctly. The following screen displays during the test.



Successful Self-Test: If the self-test is successful, the following screen displays.



Unsuccessful Self-Test

Lockout on Self-Test Error Option Enabled: If this option is enabled and a sensor fails, the following screens display before the detector deactivates.



If **Lockout on Self-Test Error** is enabled, the sensor must be replaced to activate and operate the detector. Refer to [Replacing a Sensor or Sensor Filter](#).

Lockout on Self-Test Error Option Disabled: If this option is disabled and a sensor fails the self-test, the LCD displays an error message for the applicable sensor. The startup tests continue.

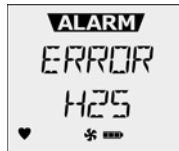

Note

Enabled sensors are continually tested while the detector is operational.

Automatic Zero for H₂S, CO, O₂, and LEL

Reminder

Only activate the detector in a safe area that is free of hazardous gas to ensure an accurate auto zero.

- To initiate auto zero during startup, the **Auto Zero on Startup** option must be enabled (sensors are enabled individually).

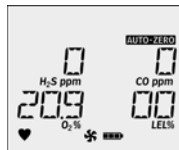

If the **Force Calibration** option is enabled and the sensor(s) is past due for calibration, the sensor will not auto zero during startup. The sensor must be calibrated.

Note

*If the **Auto Zero on Startup** option is not enabled in Fleet Manager II for any of the sensors, this startup test is bypassed.*

*If ambient air is set to be measured as 20.8% vol., the automatic oxygen calibration screen displays **20.8%** instead of **20.9%**.*

If Previous Calibration Failed

If the last calibration performed was unsuccessful, the following screens display.



Note

BW Technologies by Honeywell recommends the sensor(s) be calibrated immediately.

Calibration Due Date (optional)

9. The LCD displays the number of days remaining until the next calibration is due.



Note

*If the **Calibration Interval** field is set to **0** in Fleet Manager II, it disables the calibration due date function and this test is bypassed. Refer to [Calibration Interval](#) in the User Options.*

If any sensor is past the calibration due date, the detector beeps, flashes, and vibrates while the LCD displays the following screen.



Press to acknowledge the warning. If is not pressed within 2 minutes, the detector automatically deactivates.

Force Calibration Enabled (optional)

10. If the **Force Calibration** option is enabled in Fleet Manager II and a sensor is past due, the sensor(s) must be calibrated to continue and enter normal operation.



Press to acknowledge. Refer to [Calibration Procedure](#) to begin calibration. If is not pressed to enter calibration within 2 minutes, the detector automatically deactivates.

Cal IR Lock Enabled (optional)

11. If the **Cal IR Lock** option is enabled in Fleet Manager II, the following screen displays.



If **IR LOCK ENABLED** is enabled, the sensor(s) must be calibrated using the IR Link or the MicroDock II station. For more information, refer to [Cal IR Lock](#) in User Options.

If Previous Bump Failed

If the last bump test performed was unsuccessful, the following screens display.



Note

BW Technologies by Honeywell recommends the sensor(s) be bump tested immediately.

Bump Test

Note

BW Technologies by Honeywell recommends to bump test the sensors before each day's use to confirm their ability to respond to gas by exposing the detector to a gas concentration that exceeds the alarm setpoints.

12. The LCD next displays the number of days remaining until the next bump test is due.



Force Bump Enabled (optional)

If the **Force Bump** is enabled in Fleet Manager II and a sensor is overdue for a bump test, the sensor(s) must be tested to continue and enter normal operation. The following screen displays.



Apply gas while **BUMP DUE NOW** displays. Verify the visual, audible, and vibrator alarms activate. The detector must enter alarm to pass the bump test. For complete instructions, refer to [Bump Test](#).

If **Force Bump** is disabled, press to acknowledge the warning and continue with the startup tests.

Note

If the bump test interval field is set to 0 in Fleet Manager II, the startup bump test is bypassed. Refer to [Bump Interval](#) in the [Device Configuration](#).

The detector remains in alarm until the gas dissipates and clears from the sensors. Verify that the visual and audible alarms activate.

Startup Test Pass

If the detector passes all of the startup tests, the detector enters normal operation and displays the ambient gas readings.

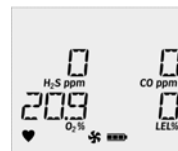

The detector begins recording the maximum gas exposure (MAX), and calculating the short-term exposure level (STEL) and time-weighted average (TWA) exposures.

Startup Test Fail

After the detector enters normal operation, **ERR** displays if a sensor has failed the self-test. To determine the cause and solutions for a failed sensor, refer to [Troubleshooting](#).



Installing Fleet Manager II

Fleet Manager II is required to configure the detector. To install Fleet Manager II, refer to the Fleet Manager II CD-ROM that includes the

- installation wizard, and
- *Fleet Manager II Operator's Manual*.

From the **User Options** tab in Fleet Manager II, two sections are provided to add data, enable/disable features, and to define settings for the sensors and the detector. They are as follows:

- [Device Configuration](#)
- [Sensor Configuration](#)

Using Fleet Manager II to Configure the Detector

When Fleet Manager II is installed, refer to [Table 6](#), [Figure 3](#), and the following procedures:

Table 6. Connecting the IR Link

Item	Description
1	IR and charger interface
2	GasAlertMax XT II
3	IR Link
4	USB cable

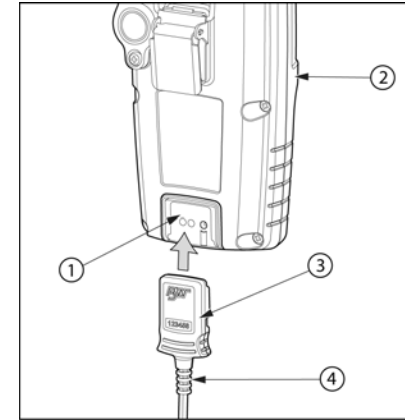

Figure 3. Connecting the IR Link

1. Activate the detector and wait for the startup tests to complete.
2. Connect the USB cable to the USB port on the computer.
3. Connect the USB cable to the IR Link.
4. Insert the IR Link into the IR interface on the back of the detector.
5. From the PC, open Fleet Manager II.
6. Click **Administration**.
7. From the **Administration** toolbar, click **Login / Logout** to access the **Enter Password** dialog box. Enter **Admin** and click **OK**.

8. From the **Devices** toolbar, click **Configure Device via IR Link** to access the GasAlertMax XT Configuration window.
9. From the configuration window, click **Retrieve from Device** at the bottom of the window.
10. Refer to the following sections in this guide for descriptions about how to enter data, enable/disable, and define settings.
11. When all settings are defined, click **Save to Device** at the bottom of the configuration window to save the configuration to the detector.

Device Configuration

The **Device Configuration** section displays data about the detector, allows for a startup message to be entered, and is used to enable/disable and define settings for the detector.

The screenshot shows the 'Device Configuration' window with the following settings:

Setting	Value
Serial Number	MA207-000000
Firmware Version	
Hardware Version:	1
Startup Message Top Line	G A MAX
Startup Message Bottom Line	X T
Lockout on Self-Test Error	<input type="checkbox"/>
Safe Mode	<input type="checkbox"/>
Confidence Beep	<input type="checkbox"/>
Latching Alarms	<input type="checkbox"/>
Force Calibration	<input type="checkbox"/>
Force Bump	<input type="checkbox"/>
Cal IR Lock	<input type="checkbox"/>
Location Logging	<input type="checkbox"/>
Force Block Test	<input type="checkbox"/>
Datalog Interval (seconds):	15
Confidence Interval (seconds):	10
Language	English

Figure 4. Device Configuration Section

Refer to the following options for descriptions and functionality.

Note

*The **Serial Number**, **Firmware Version**, and **Hardware Version** fields require no data entry. Settings for these fields are factory defined.*

Serial Number Field

This field displays the serial number (e.g. **MA110-001000**) of the detector.

Firmware Version

This field displays the current firmware version (e.g. **02_000**) that displays on the detector LCD during the startup tests. If new firmware is uploaded to the detector, the **Firmware Version** field automatically updates.

Hardware Version

This field displays the current version of hardware the detector is operating with.

Startup Message Top Line

Enter a line of text that will display on the detector LCD during startup (maximum 25 characters, spaces included). Enter any type of information such as employee name, plant, area, emergency number(s), etc.

Depending upon the length of the message, text will either display or scroll across the top line of the LCD.

Startup Message Bottom Line

Enter a line of text that will display on the detector LCD during startup (maximum 25 characters, spaces included). Enter any type of information such as employee name, plant, area, emergency number(s), etc.

Depending upon the length of the message, text will either display or scroll across the bottom line of the LCD.

The user options define the settings for the detector.

Note

When options are enabled/disabled, the checkbox displays with a red frame until the new settings are saved to the detector.

Lockout on Self-Test Error (failed sensor lock)

If enabled and a sensor fails during startup, the following screens display and the detector deactivates.



To enter normal operation, the sensor must be operating correctly. Refer to [Troubleshooting](#) and [Replacing a Sensor or Sensor Filter](#).

The detector is shipped with the **Lockout on Self-Test Error** option disabled.

Safe Mode

If enabled, **SAFE** displays continuously on the LCD unless an alarm condition occurs.



If an alarm condition occurs, the LCD displays the real-time readings for each sensor.

Confidence Beep

If enabled, the confidence beep provides continuous confirmation that the detector is operating correctly. To define how often the detector beeps (every 1-120 seconds), enter the value in the [Confidence Interval](#) field.

Note

Confidence beep automatically disables during a low battery alarm.

The detector is shipped with the **Confidence Beep** option disabled.

Latching Alarms

If enabled, a detector alarm persists until the alarm is acknowledged and gas concentrations are below the low alarm setpoint. The audible alarm can be temporarily deactivated by pressing , but the LCD continues to

display the high peak concentration until the alarm condition no longer exists.

The detector is shipped with the **Latching Alarms** option disabled.

Force Calibration

Force Calibration Enabled: If enabled and a sensor(s) is past due for calibration, the following screen displays.



The sensor(s) must be calibrated to continue and enter normal operation. For complete instructions, refer to [Calibration](#).

Note

If the calibration is unsuccessful for any of the sensors, the detector deactivates.

Force Calibration Disabled: If disabled, the **CAL DUE NOW** screen displays. Press to acknowledge the warning and enter normal operation.

The detector is shipped with the **Force Calibration** option disabled.

Note

If overdue for calibration, BW recommends the sensor(s) be calibrated immediately.

Force Bump

A bump test must be performed regularly to ensure the sensor(s) are responding correctly to test gas. If enabled and the sensor(s) is past due, a bump test must be performed and the overdue sensor must enter into alarm. If this option is enabled, the following screen displays during the startup tests.



If **Force Bump** is enabled, enter a value (1-365) in the **Bump Interval (days)** field located in the **Sensor Configuration** section.

If **0** is entered in the **Bump Interval (days)** field, the **Force Bump** option is automatically disabled.

Note

BW recommends to bump test the sensors before each day's use to confirm their ability and response to gas by exposing the detector to a gas concentration that exceeds the high alarm setpoints. Verify that the audible and visual alarms activate. Calibrate if the readings are not within the specified limits.

For complete instructions to perform a bump test, refer to [Bump Test](#).

The detector is shipped with the **Force Bump** option disabled.

Cal IR Lock

If enabled, the sensor(s) can only be calibrated using the IR Link with Fleet Manager II or the MicroDock II station.

If the **Cal IR Lock** option is enabled, the following screen displays.



Note

*The auto-zero function is not affected if the **CAL IR Lock** option is enabled. The detector still performs the auto-zero function (if enabled).*

To calibrate using an IR device, refer to one of the following:

- [Calibrating Using the IR Link](#)
- *MicroDock II Base Station User Manual*

The detector is shipped with the **CAL IR Lock** option disabled.

Note

*If the **Cal IR Lock** option is enabled and a manual calibration is attempted, the sensor(s) will only auto zero. Calibration will not be performed.*

Location Logging

The **Location Logging** logs where the detector is being used such as a gas plant, well site, vehicle, etc.

If enabled, the detector prompts for a three digit value (**1-999**) to be entered during the startup tests.



To enter a number from **1-999**, continue pressing until the desired number displays. To scroll rapidly, press and hold.



The location entries are recorded in the datalogs.

The detector is shipped with the **Location Logging** option disabled.

Force Block Test

The force block test verifies the pump is operating correctly by comparing the pump flow against the blocked flow. If the **Force Block** option is enabled, you will be prompted to manually block the pump inlet

- during the startup tests when the detector is activated, and
- when a pump alarm is acknowledged.



Caution

The diffusion cover must be attached for the pump to operate.

If the block pump test is unsuccessful, the detector deactivates.

For more information about the block test that is performed during startup, refer to [Pump Test on Startup](#).

The detector is shipped with the **Force Block Test** option disabled.

Datalog Interval

The **Datalog Interval (seconds)** field defines how often the detector records a datalog sample (every **1-120** seconds). Enter the desired value.

Confidence Interval

The **Confidence Interval (seconds)** field defines how often the confidence beep occurs (detector beeps).

Enter the desired value (every **1-120** seconds). The **Confidence Beep** option must be enabled.

Language

The **Language** field provides a drop down menu that includes the following language options:

- English
- Français
- Deutsch
- Español
- Português

From the drop down menu, select the required language. When the settings are saved to the detector, the LCD displays all screens in the selected language.



The detector is shipped with **English** displaying as the default language.

Sensor Configuration

The **Sensor Configuration** tab adjusts settings for each individual sensor. A separate sensor tab is provided for each sensor. [Figure 5](#) shows the available option settings for the H₂S sensor.

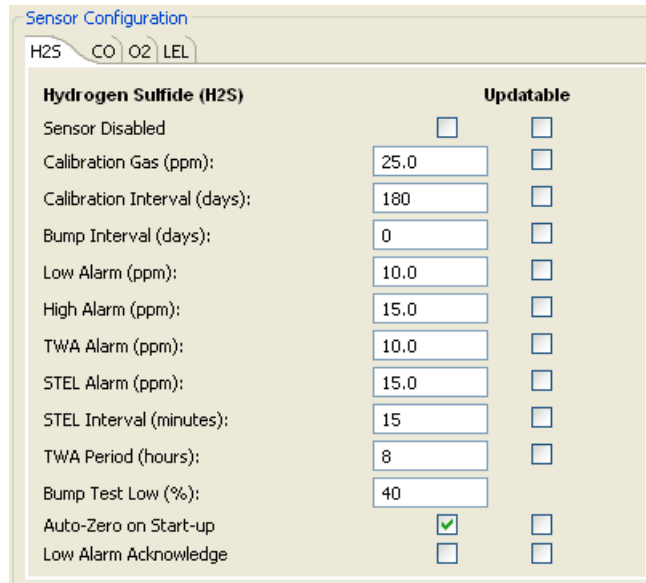

Figure 5. Sensor Configuration Tab (H₂S)

Note

Depending upon the sensor, the options may vary.

Sensor Disabled

Warning

Use extreme caution when disabling a sensor. The disabled sensor cannot detect and alarm against the applicable gas.

To disable a sensor, complete the following:

1. Click **Retrieve from Device** to populate the fields with the current detector settings.
2. Click the tab of the sensor to be disabled.
3. Click the checkbox for **Sensor Disabled**.

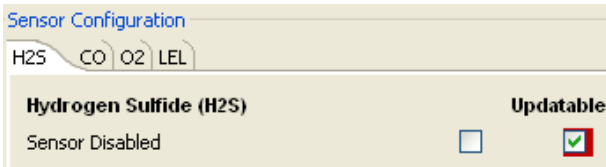

Note

When options are enabled/disabled, the checkbox displays with a red frame until the new settings are saved to the detector.

4. Click the **Save to Device** button located at the bottom of the window.

5. The LCD automatically updates. In the following example, the CO gas type and sensor readings no longer displays.

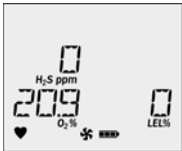

Calibration Gas (ppm)

Warning

The gas concentration value entered in Fleet Manager II must match the gas concentration value on the gas cylinder.

1. Select the applicable sensor tab.
2. Enter the gas concentration value in the **Calibration Gas (ppm)** field for H₂S and CO.
3. Enter the gas concentration value in the **Calibration Gas (%)** field for O₂ and LEL.

Note

The gas concentration value for the O₂ sensor must be calibrated with a %value other than 20.9 or 20.8%, such as 18%.

Calibration Interval

Define how often a sensor must be calibrated in the **Calibration Interval (days)** field. A different calibration interval can be set for each sensor.

1. Enter the value (**0-365** days) for each sensor.
2. Enter **0** to disable the calibration interval option. Entering **0** automatically deactivates the **Force Calibration** user option.

Note

BW recommends that the detector be calibrated at least once every 180 days (6 months).

The detector is shipped with the factory default set to **180** days.

Bump Interval

Define how often a bump test must be performed for each sensor in the **Bump Interval (days)** field. A different bump interval can be set for each sensor.

1. Enter the value (**1-365** days) for each sensor.
2. Enter **0** to disable the bump interval option. Entering **0** automatically deactivates the **Force Bump** user option.

The detector is shipped with the **Force Interval** option disabled.

Note

BW recommends to bump test the sensors before each day's use to confirm their ability and response to gas by exposing the detector to a gas concentration that exceeds the high alarm

setpoints. Verify that the audible and visual alarms activate. Calibrate if the readings are not within the specified limits.

Low Alarm

Enter the low alarm setpoints for each sensor (applicable to all sensors). Refer to [Resetting Gas Alarm Setpoints](#) for factory defined alarm setpoints.

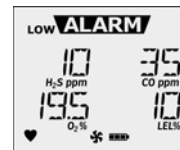

High Alarm

Enter the high alarm setpoints for each sensor (applicable to all sensors). Refer to [Resetting Gas Alarm Setpoints](#) for factory defined alarm setpoints.

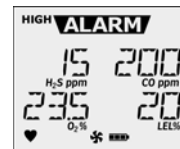

TWA Alarm

The time-weighted average (TWA) is a safety measure used to determine accumulated averages of gases. An average is determined using the Occupational Safety and Health Administration (OSHA) method to ensure the worker leaves an area when the maximum average is accumulated.

OSHA: The OSHA method is defined as a moving average that accumulates over an 8-hour average. If the worker is in the field longer, the oldest accumulated values (first hour) are replaced by the newest values (ninth hour). This continues for the duration of the work shift until the detector is deactivated.

1. Refer to [Resetting Gas Alarm Setpoints](#) for factory alarm setpoints.
2. Enter the TWA alarm setpoint for the H₂S and the CO sensor in the **TWA Alarm (ppm)** field. TWA is not applicable to O₂ and LEL.

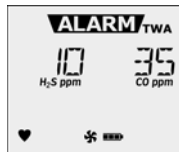

3. Enter a value (**4-16 hours**) in the **TWA Period (hours)** field to define the duration of the moving average. For more information, refer to [TWA Period \(hours\)](#).

STEL Alarm

The short term exposure limit (STEL) is the maximum permissible gas concentration a worker can be safely exposed to for short periods of time (5-15 minutes maximum).

Note

Standard factory alarm setpoints vary by region. Refer to [Resetting Gas Alarm Setpoints](#) for OSHA factory settings.

1. Refer to the applicable regulatory requirements in your area for defining STEL alarm setpoints.
2. Enter the setpoint in the **STEL Alarm (ppm)** field.

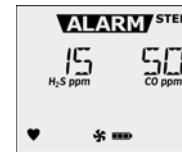

3. After entering the STEL setpoint, the STEL interval value (**5-15 minutes**) must be entered. Refer to [STEL Interval](#).

STEL Interval

The **STEL Interval** option provides protection for workers from over exposure to high concentrations of gas, and is based on user-defined 5-15 minute intervals. When the maximum STEL is reached, the detector alarms to notify the worker to leave the area immediately.

⚠ Caution

Follow all safety procedures as defined by your employer.

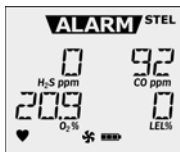

Enter the interval (**5-15 minutes**) in the **STEL Interval (minutes)** field. The detector is shipped with the STEL interval set to 15 minutes.

TWA Period (hours)

The **TWA Period (hours)** option defines a time-weighted moving average of accumulated gases over a period of 4-16 hours, to ensure the worker leaves an area when the defined maximum average is accumulated.

Example: The **TWA Period option** is set to **6** hours. Therefore, the moving average accumulates over a 6-hour average. If the worker is in the field longer, the oldest accumulated values (first hour) are replaced by the newest values (seventh hour). This continues for the duration of the work shift until the detector is deactivated.

Note

Regulations vary depending upon region. Adhere to the regulations defined for your area.

Enter a value ranging from **4-16** hours. The detector is shipped with the default setting of **8** hours.

Correction Factor (%)

The **Correction Factor (%)** option is used to enter compensation factors for hydrocarbons other than methane. The correction factor is only applicable to LEL and can only be applied if the LEL sensor has been calibrated with methane.

⚠ Caution

Ensure the calculations are correct for the applicable gas to ensure the reading display as 100% LEL.

Enter a K-factor (industry standard decimal value) in the **Correction Factor (%)** field. Values can range from **0.50 - 4.00**.

Note

Not applicable to a % by vol CH₄ measuring mode.

The detector is shipped with the factory default set to **100%**.

50% LEL = (%CH4)

If the **LEL By Volume CH4** option is enabled, a percentage value can be entered in the **50% LEL = (%CH4)** field to display the LEL reading in %vol. assuming a methane environment.

Enter the equivalent methane concentration for 50% LEL as follows:

- North America = 2.5%
- Europe = 2.2%

This option is only applicable to the LEL sensor.

Auto Zero on Startup

When enabled, the sensors automatically zero during the startup tests. The **Auto Zero on Startup** option is available for the CO, H₂S, LEL, and O₂ sensors.

The detector is shipped with the Auto Zero on Startup option enabled for all sensors.

LEL by Volume CH4

If enabled, the detector LCD displays the LEL value as %vol. assuming a methane environment.

If **LEL by Volume CH4** is enabled, a percentage value must be entered in the **50% LEL = (%CH4)** field. Refer to [50% LEL = \(%CH4\)](#).

10% (of reading) Over-span

When enabled, the detector automatically over-spans the LEL sensor by 10% of the span concentration to ensure the span meets CSA standards. After enabling this option in Fleet Manager II, a calibration (manual or using the MicroDock II) must be completed to fully enable this option.

20.8 Base Reading

If the **20.8 Base Reading** option is enabled, the detector assumes 20.8 % O₂ as ambient air (factory default is 20.9% O₂).

The detector is shipped with this option disabled.

Low Alarm Acknowledge

If enabled, the audible alarm can be disabled during a low alarm condition. The LED and visual alarm indicators remain active until the the alarm condition changes or the detector deactivates.

Press to acknowledge the low alarm and deactivate the audible alarm.

Note

The Low Alarm Acknowledge option is not applicable to O₂.

The detector is shipped with the **Low Alarm Acknowledge** disabled.

Alarms

Table 7 describes the detector alarms and corresponding screens. During an alarm condition, the detector activates the backlight, audible/visual/vibrator alarms, and displays the current ambient gas reading. If more than one type or level of alarm exists simultaneously, a multi-gas alarm results.

To change the factory-defined alarm setpoints, refer to [Low Alarm](#), [High Alarm](#), [TWA Alarm](#), and [STEL Alarm](#) in [Device Configuration](#).

Table 7. Alarms

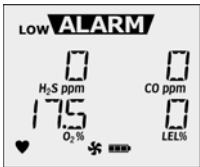
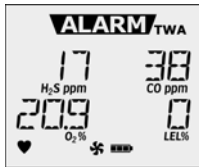
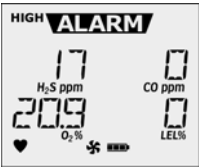
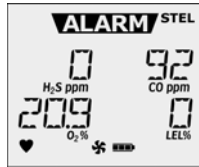
Alarm	Screen	Alarm	Screen
<p>Low Alarm</p> <ul style="list-style-type: none"> • Slow siren • Slow alternating flash • ALARM and target gas bar flash • Vibrator alarm activates 		<p>TWA Alarm</p> <ul style="list-style-type: none"> • Fast siren • Fast alternating flash • ALARM and target gas bar flash • Vibrator alarm activates 	
<p>High Alarm</p> <ul style="list-style-type: none"> • Fast siren • Fast alternating flash • ALARM and target gas bar flash • Vibrator alarm activates 		<p>STEL Alarm</p> <ul style="list-style-type: none"> • Fast siren • Fast alternating flash • ALARM and target gas bar flash • Vibrator alarm activates 	

Note



If the **Low Alarm Acknowledge** option is enabled, the audible alarm can be disabled during a low alarm condition. The LED and visual alarm indicators remain active until the alarm condition changes or the detector deactivates. Press  to acknowledge the low alarm and deactivate the audible alarm. If the alarm escalates to a high, TWA, or STEL alarm, the audible alarm reactivates.

Table 7. Alarms

Alarm	Screen	Alarm	Screen
<p>Multi-Gas Alarm</p> <ul style="list-style-type: none"> Alternating low and high alarm siren and flash ALARM and target gas bar flash Vibrator alarm activates 		<p>Sensor Alarm</p> <ul style="list-style-type: none"> ERR displays 	
<p>Over Limit (OL) Alarm</p> <ul style="list-style-type: none"> Fast siren and alternating flash ALARM and target gas bar flash Vibrator alarm activates 		<p>Low Battery Alarm</p> <ul style="list-style-type: none"> Sequence of 10 rapid sirens and alternating flashes with 7 seconds of silence in between (continues for 10 minutes)  and ALARM flashes LOW BATTERY displays and the vibrator alarm activates After 10 minutes, a sequence of 10 rapid sirens and alternating flashes with 1 second of silence in between (reactivates seven times) TURNING OFF displays before the detector deactivates 	

Note

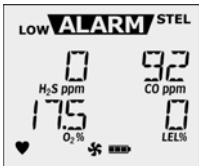
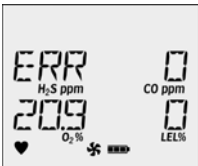
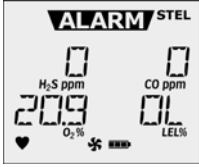



If enabled, during an alarm condition the **Latched Alarms** option causes the low and high gas alarms (audible, visual, and vibrator) to persist until the alarm is acknowledged (by pressing ) and the gas concentration is below the low alarm setpoint. The LCD displays the peak concentration until the alarm condition no longer exists. Enable/disable **Latching Alarms** in Fleet Manager II. Local regulations may require **Latching Alarms** be enabled.

Table 7. Alarms

Alarm	Screen	Alarm	Screen
<p>Automatic Deactivation Alarm</p> <ul style="list-style-type: none"> Sequence of 10 rapid sirens and alternating flashes with 1 second of silence in between (reactivates seven times) ALARM flashes and the vibrator alarm activates TURNING OFF displays before the detector deactivates 		<p>Confidence Beep</p> <ul style="list-style-type: none"> One beep every 1-120 seconds (user-defined) <p><i>Note</i> Confidence beep automatically deactivates during a low battery alarm.</p>	
<p>Normal Deactivation</p> <ul style="list-style-type: none"> Four beeps and flashes Vibrator alarm activates briefly Countdown initiates 		<p>Heartbeat</p> <ul style="list-style-type: none"> ♥ flashes once every second 	
<p>Pump Alarm</p> <ul style="list-style-type: none"> Two beeps and flashes 🌀 and ALARM flashes HIGH displays Vibrator alarm activates 			

Computed Gas Exposures

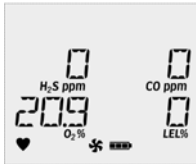
⚠ Warning

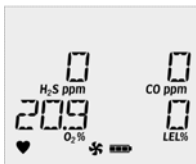
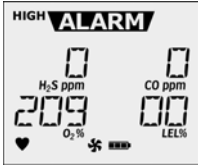
To prevent possible personal injury, do not deactivate the detector during a work shift. TWA, STEL, and MAX readings reset when the detector is deactivated.

Table 8. Computed Gas Exposures

Gas Exposure	Description
TWA (H ₂ S and CO only)	Time-weighted average (TWA) based on accumulated exposure to toxic gases averaged over a work-day according to OSHA method. Default: OSHA 8 hour moving average. User-defined: 4-16 hour moving average.
STEL (H ₂ S and CO only)	Short-term exposure limit (STEL) to gas based on a 5-15 minute user-defined period.
Maximum* (peak)	Maximum (MAX) concentration encountered during work shift.

* For oxygen, it is the highest or the lowest concentration encountered.

Viewing and Clearing Gas Exposures

To view the TWA, STEL, and maximum (MAX) readings, press  twice rapidly. The LCD first displays the current time and date.



Then, the TWA gas exposures display.

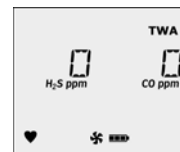

Next, the STEL gas exposures display.

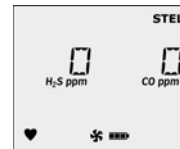

GasAlertMax XT II

Technical Reference Guide

Next, the MAX readings display.

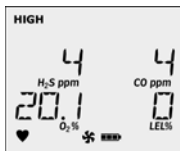

Last, the **CLEAR ALL** readings screen displays.

To clear the TWA, STEL, and MAX exposure readings, press  when the following screen displays.



Warning

Follow all safety procedures as defined by your employer.

Deactivating the detector clears all readings. Confirm with your supervisor before clearing TWA and STEL alarms.

Gas Alarm Setpoints

The alarm setpoints trigger the gas alarms and are described [Table 9](#).

Table 9. Gas Alarm Setpoints

Alarm	Condition
Low alarm	<i>Toxics and combustibles:</i> Ambient gas level above low alarm setpoint. <i>Oxygen:</i> Ambient gas level may be set above or below 20.9% (or 20.8%).
High alarm	<i>Toxics and combustibles:</i> Ambient gas level above high alarm setpoint. <i>Oxygen:</i> Ambient gas level may be set above or below 20.9% (or 20.8%).
TWA alarm	<i>Toxic only:</i> Accumulated value above the TWA alarm setpoint.
STEL alarm	<i>Toxic only:</i> Accumulated value above the STEL alarm setpoint.
Multi-gas alarm	Two or more gas alarm conditions simultaneously.

Resetting Gas Alarm Setpoints

[Table 10](#) lists alarm setpoints as defined by Occupational Safety and Health Association (OSHA).

Note

Standard factory alarm setpoints vary by region.

Table 10. Sample Factory Alarm Setpoints

Gas	TWA	STEL	Low	High
O ₂	N/A	N/A	19.5% vol.	23.5% vol.
LEL	N/A	N/A	10% LEL	20% LEL
CO	35 ppm	50 ppm	35 ppm	200 ppm
H ₂ S	10 ppm	15 ppm	10 ppm	15 ppm

Note

To disable an alarm, set the alarm setpoint to 0 (zero) in Fleet Manager II.

To change the factory-defined alarm setpoints, refer to the following in User Options:

- [Low Alarm](#)
- [High Alarm](#)
- [TWA Alarm](#)
- [STEL Alarm](#)

Stopping a Gas Alarm

The low and high alarms stop when the ambient gas concentrations returns to a concentration below the low alarm setpoint.

Note

If alarms are set to latch, press  to reset the alarms.

The detector computes the TWA value based on OSHA standards and the STEL value based on a user-defined 5 to 15 minute interval. Refer to [STEL Interval](#).

The TWA and STEL alarms can be stopped either by

- deactivating and then reactivating the detector, or
- clearing the TWA/STEL/MAX exposure readings. Refer to [Viewing and Clearing Gas Exposures](#).

Caution

Follow all safety procedures as defined by your employer. Confirm with your supervisor before clearing TWA and STEL alarms.

Sensor Alarm

The detector tests for missing or defective sensors during the startup self-test and continuously thereafter. If a sensor fails the self-test, **Err** displays above the gas type of the failed sensor. If a sensor fails, refer to [Troubleshooting](#).

Pump Alarm

The pump draws air over the sensors continually. If the pump stops operating or becomes blocked, the detector activates the pump alarm.

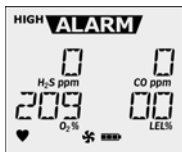

During a pump alarm, **HIGH** and **ALARM** display, and  flashes.

Note

The pump alarm displays the same as a high alarm, except that  flashes. Verify that a pump alarm is occurring before clearing the hose.

The pump alarm continues until the alarm is acknowledged by pressing .

1. Clear the blockage and press  to acknowledge. If **Force Block Test** is enabled, the detector automatically launches a pump test to verify the pump is operating correctly.
2. If the pump test is successful, the detector returns to normal operation.

If the pump test is unsuccessful, refer to [Troubleshooting](#) for possible causes and solutions.

Low Battery Alarm

The detector tests the battery on activation and continuously thereafter. Battery power is continually displayed during normal operation. If the battery voltage is low, the detector activates the low battery alarm.



The low battery alarm continues 10 minutes. If the battery voltage drops too low, the detector activates the automatic deactivation alarm.

Automatic Deactivation Alarm

If the battery is depleted below the minimum operating voltage, a sequence of ten sirens and alternating flashes activates with 1 second of silence in between. The sequence repeats seven times. The following screens displays and the detector deactivates.



To charge the detector, refer to [Charging the Battery](#).

Bump Test

A bump test is the process of applying a small amount of test gas to force the detector into alarm.

Perform a bump test to validate that the sensors are responding correctly to gas, and that the audible and visual alarms activate during an alarm condition.

To perform a bump test, complete the following:

1. Activate the detector. A bump test can be performed either during startup when the **BUMP DUE NOW** screen displays or when in normal operation.

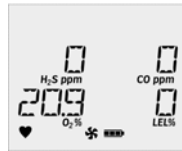

2. Attach the calibration hose to a 0.5 l/min regulator or a demand flow regulator.
3. Connect the hose quick connector to the pump quick connector on the pump inlet to apply gas.

4. The detector should enter alarm. Verify the audible and visual alarms activate, and that the LCD readings match the span gas concentrations of the gas cylinder being used.
5. Disconnect the calibration hose from the detector. The detector briefly remains in alarm until the sensors clear of the test gas.

Note

A MicroDock II station (automated bump test) is required to log bump tests as an event. A manual bump test will not be logged as an event.

Bump Test Using the MicroDock II Station

To perform an automated bump test, refer to the *MicroDock II User Manual*.

Calibration

Guidelines

Recommended gas mixture:

CO: 100 ppm balance N₂

H₂S: 25 ppm balance N₂

LEL: 50% LEL or 2.5% by vol. methane balance air

O₂: clean air, 18%

- To ensure accurate calibration, use a premium-grade calibration gas. Gases approved by the National Institute of Standards and Technology (NIST) improve the validity of the calibration.
- Do not use a gas cylinder past its expiration date.
- Calibrate a new sensor before use. Install the sensor, activate the detector, and allow the sensor to stabilize before starting calibration or a bump test.
Used sensor: 60 seconds / new sensor: 5 minutes.
- Calibrate the detector at least once every 180 days, depending upon use and sensor exposure to poisons and contaminants.
- Calibrate the detector if the ambient gas varies during startup.
- Calibrate only in a safe area that is free of hazardous gas.
- Do not calibrate the detector during or immediately after charging is complete.
- The H₂S, CO, LEL and O₂ sensors can be automatically zeroed each time the detector is activated if the **Auto-Zero on Startup** option is enabled. Activate the detector in a normal (20.9%/20.8% O₂) atmosphere.

- If a certified calibration is required, contact [BW Technologies by Honeywell](#).
- Calibration can be performed using either a 0.5 l/min regulator or a demand flow regulator.
- The maximum hose length for calibration is 3 ft (0.9 m).

Warning

Calibration cylinders that are used with a demand flow regulator must meet the following maximum inlet pressure specifications:

- **Disposable cylinders 0-1000 psig/70 bar**
- **Refillable cylinders 0-3000 psig/70 bar**

BW recommends using premium grade calibration gases and cylinders that are certified to National Standards. The calibration gases must meet the accuracy of the detector.

Diagnostics Protection

The detector tests the ambient air (auto-zero) and the test gas that is applied (auto span) to ensure it meets expected values. Auto-zero sets the zero-gas level of the sensor. If the target gas is present, the zero level will be incorrect.

If excessive target gas is present, the sensor(s) will fail and an error message displays.



In auto span, an error message displays if the target gas does not meet the expected values.



Sensor(s) that fail to span retain the previous span value and do not continue the calibration process.

Connecting the Gas Cylinder to the Detector

Refer to the following procedures and [Figure 6](#), to connect the gas cylinder to the detector for calibration.

Note

Read all of the following procedures before beginning calibration.

⚠ Caution

The maximum hose length for calibration is 3 ft (0.9 m).

1. Verify the calibration gas being used matches the span concentration value(s) that are set for the detector.
2. Attach a 0.5 l/min regulator or a demand flow regulator to the gas cylinder.
3. Connect the calibration hose to the regulator on the gas cylinder.
4. Begin the calibration procedures. Refer to the [Calibration Procedure](#) section.

5. When calibration is complete, disconnect the hose from the detector and the regulator.
6. Ensure the gas cylinder is stored according to the manufacturer's specifications.

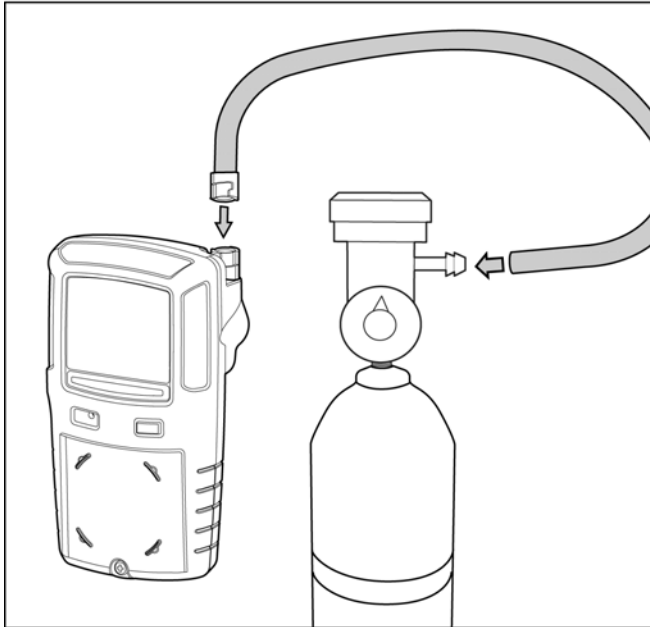

Figure 6. Connecting the Gas Cylinder to the Detector

Calibration Procedure

⚠ Caution

Calibrate only in a safe area that is free of hazardous gas. Do not calibrate the detector during or immediately after charging.



Note

*Calibration can be aborted at any time. To abort calibration, press **○**. The following screen displays.*



To calibrate the sensor(s), complete the following:

1. Activate the detector.
2. Ensure the sensor(s) to be calibrated is enabled in Fleet Manager II.
3. Verify the calibration gas being used matches the span concentration value(s) that are set for the detector.

4. Press and hold  while the detector performs the **OFF** countdown. Continue to hold  as the detector briefly deactivates.



The detector then reactivates and performs the calibration countdown. Continue to hold  until the countdown is complete.



Note

If  is not held for the entire countdown, the detector will deactivate.

Auto Zero Sensor

Note

Do not apply calibration gas until **Apply Gas** displays, otherwise the auto zero function will fail.

AUTO-ZERO flashes while the detector automatically zeroes the combustible and toxic sensors, and calibrates the oxygen sensor.

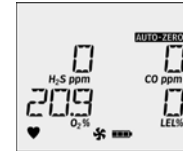

When auto zero is complete, the detector beeps two times.

Auto Zero Successful: If the sensor(s) successfully zeroes, the detector automatically proceeds to the [Auto Span](#) function.

Auto Zero Unsuccessful: If a sensor(s) fails auto zero, an error message and which sensor(s) failed displays.

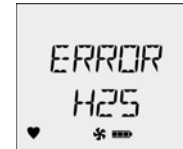

To determine the cause and solutions for the failed sensor(s), refer to [Troubleshooting](#).

Auto Span

When auto zero is complete, **APPLY GAS** and **AUTO-SPAN** display, and  flashes.

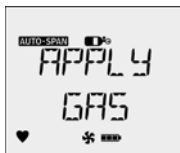

5. Connect the calibration hose to the regulator on the gas cylinder ([Figure 6](#)).
6. Attach the hose quick connector to the pump quick connector to apply gas.

After 50% of the gas is detected on all sensors (within 30 seconds), **AUTO-SPAN** continues to flash while the detector completes the span (approximately 2 minutes).

Successful Span

7. If the sensors have successfully passed the span, the audible alarm beeps and continues with calibration. Proceed to [Calibration Due Date](#).

Unsuccessful Span

If the sensor(s) fails the span, the following screen displays.

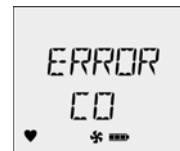

Refer to the following for possible causes and solutions.

The detector will not span a sensor if

- gas is not applied to the sensor,
- 50% of the expected gas concentration is not detected within the first 30 seconds, or
- the gas concentration drops below 50% of the expected gas level during the 2-minute span.

If gas is applied to a sensor and the detector fails to span the sensor, perform the following:

- Repeat the calibration using a new gas cylinder.
- Repeat the calibration using a new 0.5 l/min regulator or a new demand flow regulator.
- If the sensor fails the span a second time, replace the sensor. Refer to [Replacing a Sensor or Sensor Filter](#).

If a sensor(s) fails any step of the calibration, the following screen displays.



Note

If calibration is unsuccessful for a sensor(s), the calibration due date cannot be set for the failed sensor(s).

Calibration Due Date

If a sensor(s) does not successfully span, the calibration due date for that sensor(s) will not reset.

GasAlertMax XT II

Technical Reference Guide

After the span is complete, the following calibration due date screens display before returning to normal operation.

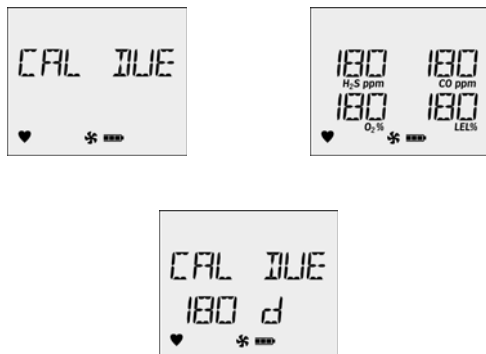

The number of days that displays in the **CAL DUE XXX DAYS** screen is the earliest date (overall of all sensors) a calibration must be performed.

Example: The H₂S sensor has the earliest date. The H₂S sensor must be calibrated in **65** days.

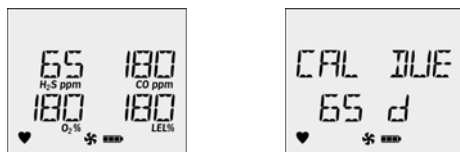

If a sensor fails to span successfully and it is past the calibration due date, the following screens display.

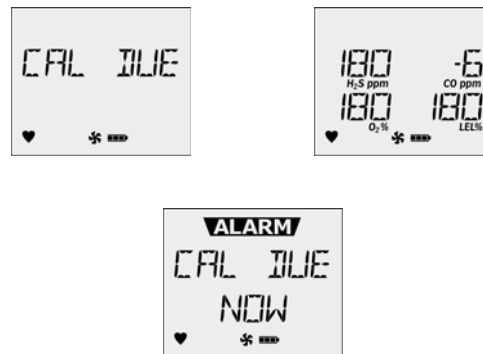

The example above shows the CO sensor is **6** days past due.

8. Press to acknowledge the warning before returning to normal operation. Refer to [Troubleshooting](#) and calibrate the failed sensor again.

Verification

1. After calibration is complete and the detector returns to normal operation, verify the calibration using a gas cylinder other than the one used for calibration.
2. The gas concentration should not exceed the sensor's detection range. Confirm that the LCD shows the expected concentration values.

3. To ensure the readings are accurate, apply the verification gas for the same amount of time as was applied to the sensor when it was calibrated.

Example: H₂S span time 2 minutes therefore, apply verification gas for 2 minutes.

Calibrating Using the IR Link

If the **Cal IR** option is enabled, the sensors must be calibrated using either the IR Link or MicroDock II station.



To calibrate using the IR Link, complete the following:

1. From the PC, open Fleet Manager II.
2. Click **Administration**.
3. From the **Administration toolbar**, click **Login / Logout** to access the **Enter Password** dialog box. Enter **Admin** and click **OK**.
4. From the **Devices toolbar**, click **Detector Configuration**.
5. Activate the detector.

Calibration can be performed during the startup tests when **CAL DUE NOW** displays, or when the detector in normal operation.

6. From Fleet Manager II, click the **Calibrate** button located at the bottom of the window.

The **Calibrate Device** dialog box displays.

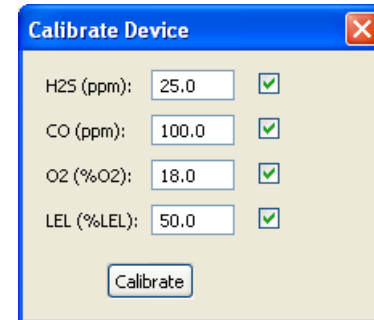
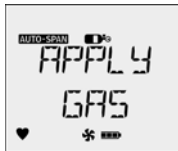

Figure 7. Calibrate Device Dialog Box

7. Enter the span gas concentration values. The values entered in the Calibrate Device popup must match the span concentration values on the gas cylinder.
8. Click inside the checkbox for each sensor that will be calibrated, and then click **Calibrate**.

The following screen displays.



9. Refer to [Auto Span](#) to complete calibration.

Note

To calibrate using the MicroDock II, refer to the MicroDock II User Manual and the Fleet Manager II Operator's Manual.

Event Logs

The detector records the thirty most recent gas alarm events. Information that is recorded from an event is as follows:

- Serial number of the detector
- Start time of alarm
- Type, level, and duration of alarm
- Status of sensor
- Peak exposure level (ppm or %)
- Status of the detector
- Detector user
- Supervisor
- Location
- Definables (employee information)

Datalogs

The detector records datalog samples that can be compiled to create a report using Fleet Manager II. From Fleet Manager II, define how often the detector records a datalog sample (**1-120** seconds) in the **Datalog Interval (seconds)** field.

The detector is capable of storing 6 hours to 5 years of information, depending upon the datalog interval and what information is stored. When the memory is full, the detector replaces the oldest datalogs with the most recent datalogs.

The following information is recorded in a datalog:

- Serial number of the detector
- Date and time
- Type of datalog
- Detector status
- Detector user
- Type of gases the detector monitors
- Gas readings
- STEL and TWA readings (H₂S and CO only)
- Alarm setpoints
- Options enabled/disabled
- Sensor status
- Pump status
- Logging intervals
- Language detector is set to display
- Calibrations performed
- Bump tests performed
- Battery readings
- Temperature readings

Bump and Calibration Results

The detector records the bump test and calibration results. The results can then be imported into Fleet Manager II to create detailed reports.

The following information is recorded in the Bump/Calibration datalogs:

- Date/time bump tests and calibrations were performed
- Serial number of the detector
- Test performed
- Test results
- Detector user
- Supervisor
- Detector status
- Detector configuration updated during bump test/calibration
- Type of detector
- Location detector was used
- MicroDock II serial number
- MicroDock II location
- Last calibration performed
- Next calibration due date
- Last bump test performed
- Next bump test due date
- Datalog interval
- STEL period
- Pump enabled/disabled

- Audible and visual indicator status
- Sensor type and sensor status
- Alarm status
- Sensor status
- Inlet(s) used
- Definables (employee information)

Downloading Datalogs and Event Logs

The datalog and event log files can only be downloaded to a PC using the IR Link or the MicroDock II Base Station. Refer to the *Fleet Manager II Operator's Manual*.

Software Requirements

Fleet Manager II and Excel software are required to create spreadsheet reports of the event logs, datalogs, and bump and calibration results.

Maintenance

To maintain the detector in good operating condition, perform the following basic maintenance as required.

- Calibrate, bump test, and inspect the detector at regular intervals.
- Maintain an operations log of all maintenance, bump tests, calibrations, and alarm events.
- Clean the exterior with a soft damp cloth. Do not use solvents, soaps, or polishes.
- Do not immerse the detector in liquids.

Maximum Hose Length for Sampling

The maximum hose length for sampling is 75 ft (22m).

Battery Maintenance and Cautions

⚠ Warning

To avoid personal injury and/or property damage, adhere to the following:

- The detector must be deactivated to charge the battery.
- Charge the battery immediately when the detector emits a low battery alarm. Refer to [Charging the Battery](#).
- Charge the battery using the GasAlertMax XT II or the GasAlertMicroClip charger adapter only. Do not use any other charger adapters. Failure to adhere to this precaution can lead to fire and/or explosion.

- Do not calibrate the detector during or immediately after charging the battery.
- **Warning:** The GasAlertMax XT II uses a lithium battery (MX-BAT01) that may present a risk of fire or chemical burn hazard if misused. Do not disassemble, heat above 212° (100°C), or incinerate.
- **Warning:** Lithium polymer cells exposed to heat at 266°F (130°C) for 10 minutes can cause fire and/or explosion.
- If replacing the battery, use only approved lithium polymer cells that are available through BW Technologies by Honeywell. Use of any other cell can cause fire and/or explosion. To order and replace the MX-BAT01 lithium battery, refer to [Replacement Parts and Accessories](#).
- Replace the battery only in a safe area that is free of hazardous gas.
- Dispose of used lithium cells immediately. Do not disassemble and do not dispose of in fire. Do not mix with the solid waste stream. Spent batteries must be disposed of by a qualified recycler or hazardous materials handler.
- Keep lithium cells away from children.

Charging the Battery

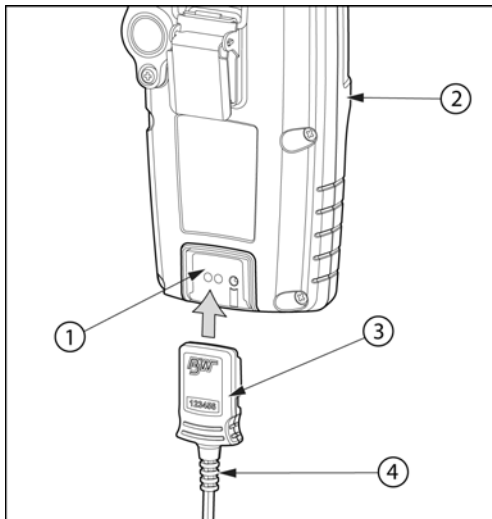

Figure 8. Connecting the Charger Adapter

Table 11. Connecting the Charger Adapter

Item	Description
1	IR and charger interface
2	GasAlertMax XT II
3	Charger adapter
4	Charger cable

⚠ Warning

The detector must be charged in a safe area that is free of hazardous gas in temperatures of 32°F to 113°F (0°C to 45°C).

To charge the battery, refer to [Figure 8.](#), [Table 11.](#) and the following procedures:

1. Deactivate the detector.
2. Plug the charger into a AC outlet.

⚠ Caution

The charging adapter is voltage specific to your region. Use of the charging adapter outside your region will damage the charger and the detector.

3. Attach the charging adapter ([Figure 8.](#)) to the charger interface.

4. Allow the battery to charge for 6 hours. The charging indicator flashes (low, mid, and full charge repeatedly) on the LCD while the battery is charging.



low mid full

5. When charging is complete, the charging indicator stops flashing and displays to indicate a full charge. Remove the adapter and activate the detector.

If the battery indicator does not display, refer to [Troubleshooting](#).

Note

To preserve the life of the battery, deactivate the detector when not in use.

The detector may be warm immediately after charging. This is normal.

Optimum Battery Operation

To ensure maximum use of the battery, perform the following:

- To obtain full operating capacity, allow the battery to fully charge and discharge three times.
- To achieve the maximum number of charges, ensure the battery is charged between 32°F and 113°F (0°C and 45°C). Do not charge the battery in temperatures above 113°F (45°C).

Replacing the Battery

To replace the lithium battery, refer to [Replacement Parts and Accessories](#) to order the (XT-BAT-K1) kit that includes the *Replacing the GasAlertMax XT Battery Operator's Manual*.

Replacing a Sensor or Sensor Filter

Warning

To avoid personal injury and/or property damage, use only sensors that are specifically designed for the detector. Refer to [Replacement Parts and Accessories](#).

- Each sensor has a high degree of resistance to common vapors and gases. To clear a sensor, move the detector to a clean environment and wait 10 to 30 minutes.
- Do not expose a sensor to vapors from inorganic solvents such as fumes from paint thinners, or organic solvents such as benzoic acids and acrylic acids).

To replace a sensor or sensor filter, refer to

- [Table 12](#),
- [Figure 9](#),
- [Figure 10](#), and
- the following procedures.

Table 12. Replacing a Sensor or Sensor Filter

Item	Description
1	Front shell
2	LEL sensor
3	PCB
4	PCB screws (2)
5	Pump
6	Rear shell
7	Machine screws (6)
8	Pump inlet
9	Pump filter (particulate)
10	Moisture filter
11	CO sensor
12	H ₂ S sensor
13	O ₂ sensor
14	Sensor filter

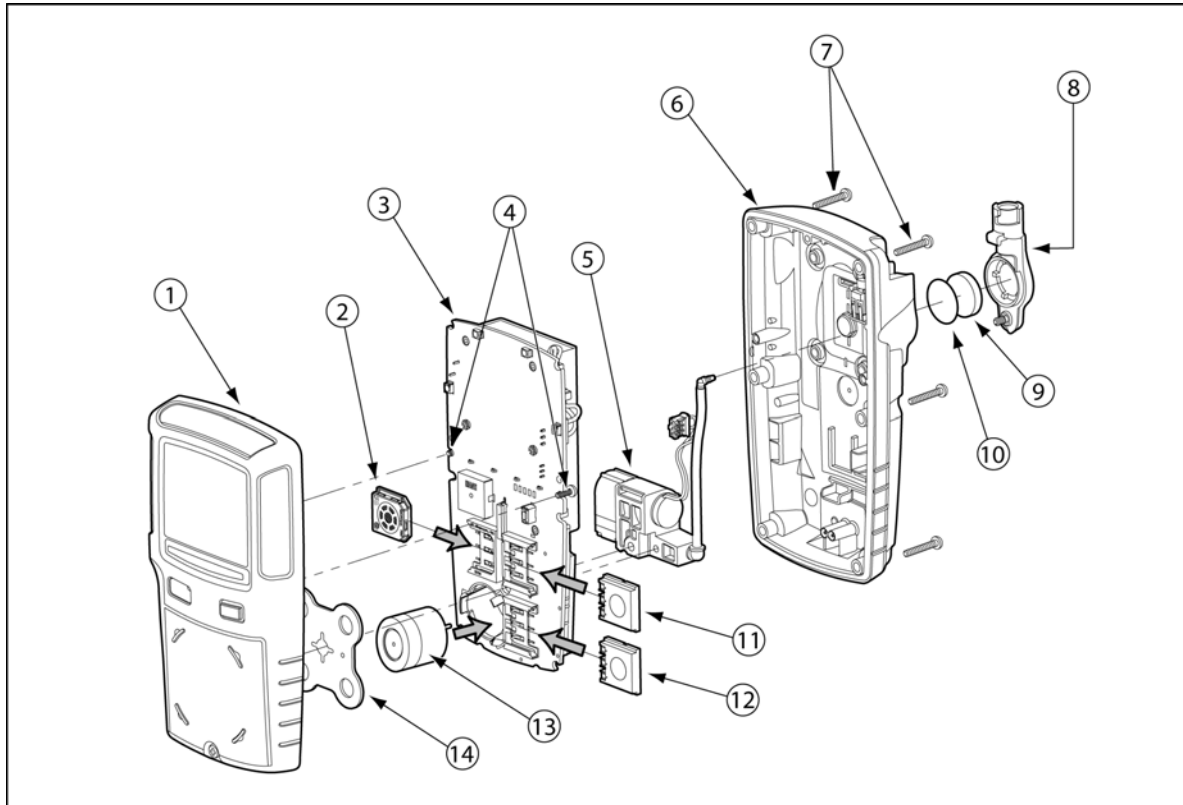

Figure 9. Replacing a Sensor or Sensor Filter

GasAlertMax XT II

Technical Reference Guide

1. Deactivate the detector.
2. Remove the pump inlet screw and the pump inlet. Refer to [Figure 13](#).
3. Remove the six machine screws from the rear shell.
4. Because the pump hose is connected to the rear shell and front shell pump, carefully remove the rear shell by lifting upward and tilting to the left. The front and rear shells are laying flat side by side ([Figure 10](#)).

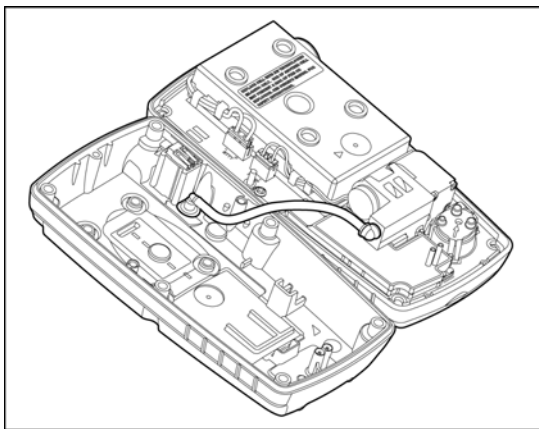

Figure 10. Front and Rear Shells Side by Side

5. Remove the two PCB screws.
6. Lift the PCB upward and tilt to the left. Lay the PCB (sensors facing up) onto the rear shell.
7. For CO, H₂S, and LEL sensors, slide outward to remove.

To remove the O₂ sensor gently insert a screwdriver to the back of the oxygen sensor to push out the sensor. Refer to [Figure 11](#).

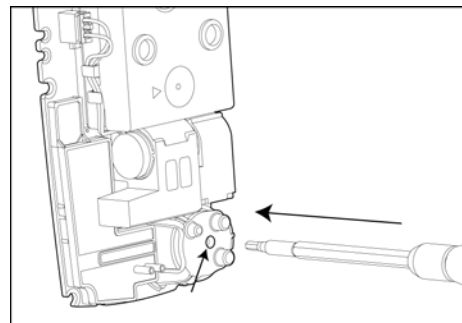

Figure 11. Remove the O₂ Sensor With a Screwdriver

Note

Detectors that are configured for 1, 2, or 3 gases may contain a dummy sensor in one of the four sensor locations.

8. Insert the new sensor(s).
9. If required, replace the sensor filter.

Note

When inserting a new sensor filter, ensure the white side is facing the sensors and the black side is facing the front shell.

10. Replace the particulate and/or moisture filter if required.
Refer to [Replacing the Pump Filters](#).
11. Re-assemble the detector and replace the PCB screws.
12. Replace the machine screws using 3-4 in-lbs. torque.
Tighten the screws using a crisscross pattern to ensure a proper seal.
13. Replace the pump inlet and the pump inlet screw.
14. Activate the detector and calibrate the sensor(s). Refer to [Calibration](#).

Replacing the Pump Filters

Filters are inserted into the pump inlet to prevent dust particulates and moisture from entering the pump module.

Particulate Filters

The particulate filter will require frequent changes if the detector is being used in heavy particulate areas. If a pump alarm occurs and there is no blockage in the tubing, replace the particulate filter.

Moisture Filters

The moisture filter will not typically require frequent changes. If moisture is drawn through the tubing, replace both the moisture filter and the particulate filter immediately.

To change the particulate or the moisture filter, refer to [Table 13](#), [Figure 12](#), and the following procedures.

Table 13. Replacing the Pump Filters

Item	Description
1	Rear shell
2	Moisture filter
3	Pump quick connector
4	Pump inlet
5	Machine screw (1)
6	Particulate filter

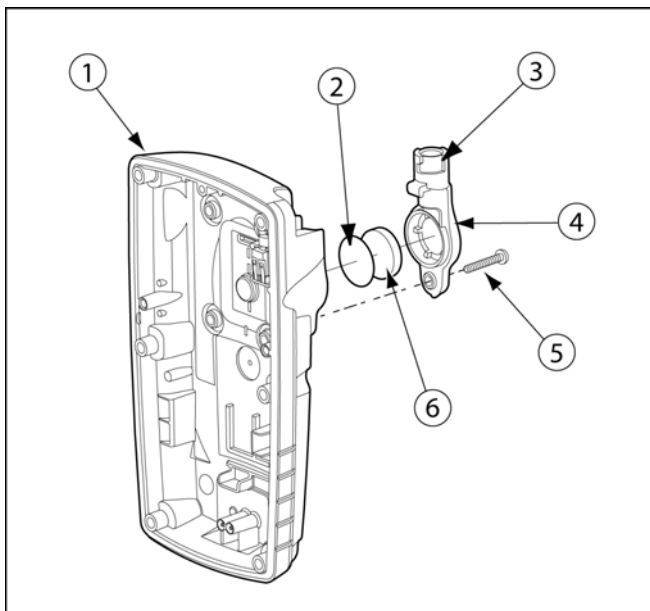

Figure 12. Replacing the Pump Filters

1. Remove the one machine screw from the pump inlet and gently lift the bottom of the inlet outward at a 45° angle.

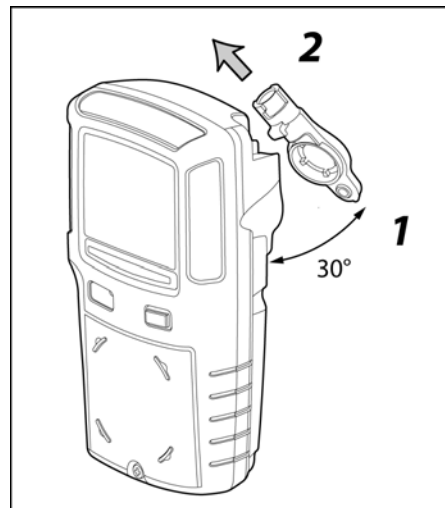

Figure 13. Removing the Pump Filters

2. Gently lift the pump inlet upwards to remove. Ensure the hook on the pump inlet clears the housing.

The particulate filter is located inside the pump inlet and the moisture filter is located on the rear shell.

3. Depending upon the circumstance, replace either just the particulate filter or both. Refer to [Particulate Filters](#) and [Moisture Filters](#).
4. Reattach the pump inlet and replace the screw. Tighten the screw using 3-4 in-lbs. torque. Do not overtighten.
5. Activate the detector to begin the startup test and the pump block test. Depending upon the result, one of the following screens display.



Successful: If the block test is successful, the detector completes the startup test and enters normal operation.

Unsuccessful: If the block test is unsuccessful, the detector deactivates. For causes and possible solutions, refer to [Troubleshooting](#).

Replacing the Pump

To obtain a new pump (XT-RPUMP-K1) and the *Pump Replacement Operator's Manual*, refer to [Replacement Parts and Accessories](#).

Troubleshooting

If a problem occurs, refer to the solutions provided in Table 15. If the problem persists, contact [BW Technologies by Honeywell](#).

Figure 14. Troubleshooting

Problem	Possible Cause	Solution
The detector does not activate.	Depleted battery	Charge the battery. Refer to Charging the Battery .
	Damaged or defective detector	Contact BW Technologies by Honeywell .
Detector automatically deactivates.	Automatic deactivation due to depleted battery	Charge the battery. Refer to Charging the Battery .
	Lockout on Self-Test Error is enabled and a sensor(s) has failed the startup self-test	Refer to Lockout on Self-Test Error and Replacing a Sensor or Sensor Filter .
The detector enters alarm immediately when activated.	Sensor needs to stabilize	Used sensor: Wait 60 seconds New sensor: Wait 5 minutes
	Low battery alarm	Charge the battery. Refer to Charging the Battery .
	Sensor(s) requires calibration	Calibrate the sensor(s). Refer to Calibration .
	Hazardous environment	Leave the area immediately. Deactivate and reactivate the detector in a safe area that is free of hazardous gas.
The activation startup self-test fails.	General fault	Contact BW Technologies by Honeywell .
	Sensor error	Replace the sensor. Refer to Replacing a Sensor or Sensor Filter .

Table 7. Troubleshooting

Problem	Possible Cause	Solution
Detector does not display normal ambient gas reading after startup tests.	Sensors not stabilized	Used sensor: Wait 60 seconds New sensor: Wait 5 minutes
	Sensor(s) requires calibration	Calibrate the sensor(s). Refer to Calibration .
	Target gas is present	Detector is operating properly. Use caution in suspect areas.
Detector does not respond to pushbutton.	Battery is depleted	Charge the battery. Refer to Charging the Battery .
	Detector is performing operations that do not require user input	Pushbutton operation restores automatically when the operation ends.
Detector does not accurately measure gas.	Sensor(s) requires calibration	Calibrate the sensor(s). Refer to Calibration .
	Detector is colder/hotter than gas temperature	Allow the detector to attain ambient temperature before use.
	Sensor filter is blocked	Replace the sensor filter. Refer to Replacing a Sensor or Sensor Filter .
Detector does not enter alarm.	Alarm setpoint(s) are set incorrectly	Reset the alarm setpoints. Refer to Resetting Gas Alarm Setpoints .
	Alarm setpoint(s) set to zero	Reset the alarm setpoints. Refer to Resetting Gas Alarm Setpoints .
	Detector is in calibration mode	Complete the calibration procedure.

Table 7. Troubleshooting

Problem	Possible Cause	Solution
Detector intermittently enters alarm without reason.	Ambient gas levels are near alarm setpoint or the sensor is exposed to a puff of the target gas	Detector is operating normally. Use caution in suspect areas. Check maximum gas exposure reading.
	Alarms are set incorrectly	Reset the alarm setpoints. Refer to Resetting Gas Alarm Setpoints .
	Sensor(s) requires calibration	Calibrate the sensor(s). Refer to Calibration .
	Missing or faulty sensor(s)	Replace the sensor(s). Refer to Resetting Gas Alarm Setpoints .
Battery has been charging for 6 hours. Charging indicator on LCD shows the battery is still charging.	Battery is trickle charging	Battery is fully charged and is ready for operation.
Battery indicator does not display when charging.	Battery is depleted below normal levels	Charge the battery for 8 hours. If the battery indicator does not light after charging, contact BW Technologies by Honeywell .
Pump is not operating.	Diffusion cap is off or not attached correctly.	Attach diffusion cap. Ensure seal is tight.
	There is a blockage in the tubing.	Clear the blockage.
	Particulate and/or moisture filter requires replacement	Replace the filter(s). Replacing the Pump Filters .
Features and options not operating as expected.	Changes in Fleet Manager II	Verify that the settings in Fleet Manager II are correct.

Replacement Parts and Accessories

⚠ Warning

To avoid personal injury or damage to the detector, use only the specified replacement parts.

To order parts or accessories listed in the following table, contact BW Technologies by Honeywell.

Table 14. Replacement Parts and Accessories

Model No.	Description	Qty
SR-W-MC75C	Combustible (LEL) sensor	1
SR-X10-C1	Oxygen (O ₂) sensor	1
SR-M-MC	Carbon monoxide (CO) sensor	1
SR-H-MC	Hydrogen sulfide (H ₂ S) sensor	1
REG-DF-1	Demand flow regulator	1
REG-0.5	0.5 l/min regulator	1
CG-Q58-4	Quad gas cylinder: CH ₄ -2.5%, O ₂ -18.0%, H ₂ S-25 ppm, CO-100 ppm, bal. N ₂ (58 l)	1
CG-Q34-4	Quad gas cylinder: CH ₄ -2.5%, O ₂ -18.0%, H ₂ S-25 ppm, CO-100 ppm, bal. N ₂ (34 l)	1
CG-T34	Dual gas cylinder: 50% LEL (CH ₄ -2.5%) O ₂ -20.9%, bal. N ₂ (34 l)	1
G0042-H25	Single gas cylinder: H ₂ S 25 ppm, bal. N ₂ (58 l)	1

Model No.	Description	Qty
CG2-M-200-103	Single gas cylinder: CO 200 ppm, bal N ₂ (103 l)	1
CG-BUMP1	Bump alarm gas aerosol (CH ₄ -2.5%, O ₂ -10%, H ₂ S-40 ppm, CO-200 ppm)	1
CK-Q34-4	Quad calibration kit with regulator, quad gas cylinder (CG-Q34-4), hose, and carrying case	1
CK-Q58-4	Quad calibration kit with regulator, quad gas cylinder (CG-Q58-4), hose, and carrying case	1
XT-SS-1	Sensor filter for GasAlertMax XT II, Kit of 2	2
GA-PFMAX	Particulate filters (kit of 5)	5
GA-PFMAX-50	Particulate filters (kit of 50)	50
GA-PFMAX-100	Particulate filters (kit of 100)	100
XT-RF-H5	Hydrophobic (moisture) filters (kit of 5)	5
XT-RF-H50	Hydrophobic (moisture) filters (kit of 50)	50
XT-C01-MC5	GasAlertMax XT multi-unit charger	1
GA-PA-1*	Charging adapter	1
DOCK2-0-1 C1M-00-N	GasAlertMax XT docking module (for use w/ MicroDock II) and charging cable	1
GA-USB1-IR	IR connectivity kit (includes USB cable and Fleet Manager II CD-ROM)	1

GasAlertMax XT II
Technical Reference Guide

Model No.	Description	Qty
XT-SCREW-K1	Replacement screw kit (40 screws and screw-driver)	1
XT-BAT-K1	Battery replacement kit	1
XT-RPUMP-K1	Pump replacement kit	1
GA-HXT	GasAlertMax XT carrying holster	1
GA-BXT	GasAlertMax XT rubber boot	1
XT-AG-1	Alligator clip (stainless steel)	1

**Add suffix (-UK) for United Kingdom mains plug,
(-EU) for European mains plug, (-AU) for Australian mains plug.*

Specifications

Instrument dimensions: 13.1 x 7.0 x 5.2 cm (5.1 x 2.8 x 2.0 in.)

Weight: 328 g (11.6 oz.)

Operating temperature: -20°C to +50°C (-4°F to +122°F)

Storage temperature: -40°C to +60°C (-40°F to +140°F)

Operating humidity: 10% to 100% relative humidity (non-condensing)

Dust and moisture ingress: IP66/67

Alarm setpoints: May vary by region and are user-defined

Detection range:

H₂S: 0 – 200 ppm (1 ppm increments)

CO: 0 – 1000 ppm (1 ppm increments)

O₂: 0 – 30.0% vol. (0.1% vol. increments)

LEL (combustible): 0 – 100% LEL (1% LEL increments) or

0 – 5.0% v/v methane

Sensor type:

H₂S, CO, O₂: Single plug-in electrochemical cell

LEL (combustibles): Plug-in catalytic bead

O₂ measuring principle: Capillary controlled concentration sensor

Alarm conditions: TWA alarm, STEL alarm, low alarm, high alarm, multi-gas alarm, over limit (OL) alarm, low battery alarm, confidence beep, automatic deactivation alarm, pump alarm

Audible alarm: 95 dB+ at 30 cm variable pulsed beeper with full battery charge

Visual alarm: Red light-emitting diodes (LEDs)

Display: Alphanumeric liquid crystal display (LCD)

Backlight: Activates upon startup and when the pushbutton is pressed; deactivates after 10 seconds. Activates during an alarm condition and remains lit until alarm ceases

Self-test: Initiated during activation, self-test runs continuously while detector is operational

Calibration: Automatic zero and automatic span

User field options: Startup message, lockout on self-test error, safe mode, confidence beep, latching alarm, force calibration, cal IR lock, force bump, location logging, force block test, set datalog interval, set confidence interval, language selection.

Sensor options: Sensor enable/disable, set span concentration values, set calibration interval, set bump interval, set alarm setpoints, set STEL interval, set TWA period, auto zero at startup enable/disable, 5% over-span, low alarm acknowledge, oxygen measurement, and combustible gas measurement

Maximum hose length for sampling: 75 ft (22 m)

Maximum hose length for calibration: 3 ft (0.9 m)

Battery operating time: One rechargeable lithium polymer battery at 20°C provides 13 hours operating runtime

Year of manufacture: The detector's year of manufacture is determined from the serial number. The first and second number after the first two letters determines the year of manufacture.

Example: MA110-001000 = 2010 year of manufacture

GasAlertMax XT II

Technical Reference Guide

Approved battery for GasAlertMax XT II product:

Lithium-ion polymer (MA-BAT01) as per standards EN50020, UL913, CSA C22.2 No. 157

Rechargeable battery (MX-BAT01) Temperature Code

Lithium Polymer $-20^{\circ}\text{C} \leq T_a \leq +50^{\circ}\text{C}$ T4

Battery charger: GasAlertMax XT II Charging Adapter

First-time charge: 6 hours

Normal charge: 6 hours

Warranty: 2 years including sensors

Approvals:

Approved by CSA to both U.S. and Canadian Standards

CAN/CSA C22.2 No. 157 and C22.2 152

ANS/UL – 913 and ANSI/ISA – S12.13 Part 1

CSA Class 1, Division 1, Group A, B, C, and D

ATEX CE 0539  II 1 G Ga Ex ia IIC T4

KEMA 08 ATEX 0001

IECEX Ex ia IIC T4 Ga

This equipment has been tested and found to comply with the limits for a Class B digital device, pursuant to Part 15 of the FCC Rules and ICES-003 Canadian EMI requirements. These limits are designed to provide reasonable protection against harmful interference in a residential installation. This equipment generates, uses and can radiate radio frequency energy and, if not installed and used in accordance with the instructions, may cause harmful interference to radio communications. However, there is no guarantee that interference will not occur in a particular installation. If this equipment does cause harmful interference to radio or television reception, which can be determined by turning the equipment off and on, the user is encouraged to try to correct the interference by one of more of the following measures:

- Reorient or relocate the receiving antenna.
- Increase the separation between the equipment and receiver.
- Connect the equipment into an outlet on a circuit different from that to which the receiver is connected.
- Consult the dealer or an experienced radio/TV technician for help.

General Datalogger Specifications

Storage: 375 hours at 15-second intervals (75% redundancy)

Memory type: Wraparound memory ensures most recent data is always saved

Sample rate: One reading every 1-120 seconds

Data recorded: All sensor readings, all alarm conditions, calibrations, event flags, battery status, sensor status, pump status, confidence beep activation, and detector status along with the time and date for each reading and unit serial number

Operation: Requires no user intervention (automatic)

Compatible with: Desktop PC computer or laptop

Operating system: Windows XP and Windows Vista

Download via: IR device (IR Link adapter or MicroDock II Base Station)

Software required: Fleet Manager II and Microsoft Excel

Wear yellow. Work safe.

iERP: 129541

D6247/1 [English]

© BW Technologies 2010. All rights reserved.