



MZ-RD

Remote Display

Instruction 3015-5157

Installation / Operation / Maintenance

Rev. 6 – December 2011



UL 61010-1

CAN/CSA 22.2 No.61010.1

Product Leadership • Training • Service • Reliability

NOTICE

Product improvements and enhancements are continuous; therefore the specifications and information contained in this document may change without notice.

Bacharach, Inc. shall not be liable for errors contained herein or for incidental or consequential damages in connection with the furnishing, performance, or use of this material.

No part of this document may be photocopied, reproduced, or translated to another language without the prior written consent of Bacharach, Inc.

Copyright © 2000–2011, Bacharach, Inc., All Rights Reserved

BACHARACH® is a registered trademark of Bacharach, Inc. All other trademarks, trade names, service marks and logos referenced herein belong to their respective owners.

WARRANTY

Bacharach, Inc. warrants to Buyer that at the time of delivery this Product will be free from defects in material and manufacture and will conform substantially to Bacharach Inc.'s applicable specifications. Bacharach's liability and Buyer's remedy under this warranty are limited to the repair or replacement, at Bacharach's option, of this Product or parts thereof returned to Seller at the factory of manufacture and shown to Bacharach Inc.'s reasonable satisfaction to have been defective; provided that written notice of the defect shall have been given by Buyer to Bacharach Inc. within two (2) years after the date of delivery of this Product by Bacharach, Inc.

Bacharach, Inc. warrants to Buyer that it will convey good title to this Product. Bacharach's liability and Buyer's remedy under this warranty of title are limited to the removal of any title defects or, at the election of Bacharach, to the replacement of this Product or parts thereof that are defective in title.

The warranty set forth in Paragraph 1 does not apply to parts the Operating Instructions designate as having a limited shelf-life or as being expended in normal use (e.g., filters).

THE FOREGOING WARRANTIES ARE EXCLUSIVE AND ARE GIVEN AND ACCEPTED IN LIEU OF (I) ANY AND ALL OTHER WARRANTIES, EXPRESS OR IMPLIED, INCLUDING WITHOUT LIMITATION THE IMPLIED WARRANTIES OF MERCHANTABILITY AND FITNESS FOR A PARTICULAR PURPOSE: AND (II) ANY OBLIGATION, LIABILITY, RIGHT, CLAIM OR REMEDY IN CONTRACT OR TORT, WHETHER OR NOT ARISING FROM BACHARACH'S NEGLIGENCE, ACTUAL OR IMPLIED. The remedies of the Buyer shall be limited to those provided herein to the exclusion of any and all other remedies including, without limitation incidental or consequential damages. No agreement varying or extending the foregoing warranties, remedies or this limitation will be binding upon Bacharach, Inc. unless in writing, signed by a duly authorized officer of Bacharach.

**Register your warranty by visiting
www.mybacharach.com**

Table of Contents

| | |
|--|-------------------------------------|
| Chapter 1. Introduction | 1 |
| 1.1. How to Use This Manual | 1 |
| 1.2. 1 | |
| Warnings and Caution Labels | 1 |
| Hazard Symbols on the Monitor | Error! Bookmark not defined. |
| 1.3. Safety Precautions | 1 |
| Altitude Limit | Error! Bookmark not defined. |
| 1.4. 2 | |
| Communications Options | 2 |
| Chapter 2..... | 3 |
| Installation | 3 |
| 2.1. Warnings and Cautions | 3 |
| 2.2. Preliminary Inspection | 3 |
| 2.3. Location of the Remote Display | 3 |
| 2.4. Mounting Instructions | 4 |
| 2.5. Interior Components..... | 6 |
| 2.6. Electrical Wiring | 7 |
| 2.7. Communications Connections | 8 |
| 2.7.1 MZ-RD Network | 8 |
| 2.7.2 Integration with Building Management System | 8 |
| 2.8. 9 | |
| Connecting External Alarms..... | 9 |
| 2.8.1 Overview | 9 |
| 2.8.2 Connection..... | 9 |
| Chapter 3. Overview | 10 |
| 3.1. General..... | 10 |
| 3.2. System Programming..... | 11 |
| 3.2.1. Setup Parameters | 11 |
| 3.2.2. Password Protection | 11 |
| 3.3. Setup Programming | 12 |
| 3.3.1. Setting the Clock | 12 |
| 3.3.2. Navigating to the 1 st MZ-RD Setup Screen..... | 12 |
| 3.3.3. Num Monitors on Net..... | 13 |
| 3.3.4. Monitor Baud..... | 13 |
| 3.3.5. Audible Alarm | 13 |
| 3.3.6. BMS..... | 14 |
| 3.3.7. BMS Baud Rate | 14 |
| 3.3.8. Password..... | 14 |

| | | |
|-----------------------|--|-----------|
| 3.3.9. | Navigating to the 2 nd MZ-RD Setup Screen..... | 14 |
| 3.3.10. | Setting Relay Parameters..... | 14 |
| 3.3.11. | Node Address..... | 14 |
| 3.3.12. | Navigating to the 1st and then 2nd Monitor Setup Screen..... | 15 |
| 3.3.13. | Navigating to the 3 rd Monitor Setup Screen..... | 16 |
| 3.4. | Zone Setup Programming..... | 17 |
| 3.4.1. | Navigating to the 1 st Zone Setup Screen..... | 17 |
| 3.4.2. | Navigating to the 2 nd Zone Setup Screen..... | 18 |
| 3.4.3. | Navigating to the Trend Screen..... | 18 |
| Chapter 4. | General Operation..... | 20 |
| 4.1. | Functional Overview..... | 20 |
| 4.2. | The Zone Screen..... | 20 |
| 4.3. | 21 | |
| Alarm Conditions..... | | 21 |
| 4.4. | Fault Conditions..... | 21 |
| 4.5. | The System Screen..... | 22 |
| 4.5.1. | Alarm Conditions..... | 22 |
| 4.5.2. | 23 | |
| Alarm Log..... | | 23 |
| 4.5.3. | Fault Conditions..... | 24 |
| 4.6. | Alarms..... | 25 |
| 4.6.1. | Functional Overview..... | 25 |
| 4.6.2. | Responding to Alarms..... | 25 |
| 4.6.3. | Alarm Detail Screen..... | 26 |
| 4.6.4. | Acknowledging Alarms..... | 26 |
| 4.7. | The Trend Screen..... | 27 |
| 4.7.1. | Overview - Log Interval..... | 27 |
| 4.7.2. | Navigating to the Trend Screen..... | 27 |
| 4.8. | System Faults..... | 28 |
| 4.8.1. | Functional Overview..... | 28 |
| 4.8.2. | Navigating to the Fault Screen..... | 29 |
| 4.8.3. | Critical Faults..... | 29 |
| 4.8.4. | Non Critical Faults..... | 30 |
| 4.8.5. | Reset to Factory Default Settings..... | 30 |
| 4.8.6. | Clearing System Faults..... | 31 |
| 4.8.7. | Viewing Fault Log..... | 31 |
| 4.9. | The Calibration Screen..... | 32 |
| 4.9.1. | Overview..... | 32 |
| 4.9.2. | Navigating to the Calibration Screen..... | 32 |
| 4.9.3. | Adjusting Calibration Factor..... | 33 |
| 4.10. | The Diagnostic Screen..... | 33 |

| | |
|---|-----------|
| 4.10.1. Overview | 33 |
| 4.10.2. Navigating to the Diagnostic Screen | 33 |
| 4.10.3. Diagnostic Screen Overview..... | 34 |
| 4.11. 35 | |
| Service Mode | 35 |
| Appendix A. Logic Diagram | 38 |
| Appendix B. Specifications | 40 |
| Appendix C. Agency Approvals | 42 |
| Appendix D. Service Centers..... | 44 |

CHAPTER 1. INTRODUCTION

1.1. How to Use This Manual

Thank you for investing in a Bacharach MZ-RD Remote Display. To assure operator safety and the proper use of the MZ-RD please read, understand, and follow the contents of this manual, which provides important information on the installation, operation, and maintenance of the monitor.

If you have a working knowledge of refrigerant monitors, you will find this manual useful as a reference tool. If you are new to the use of refrigerant monitors, you can educate yourself about the principles of refrigerant gas detection and the proper operation of this device by reading this manual thoroughly. This manual provides important information on how to install, operate, and service the Remote Display.

1.2. Warnings and Caution Labels

When used in this manual or as **labeled on the MZ-RD**, the following hazard symbols and/or associated words are defined as follows.



WARNING: This symbol and/or the use of the word **WARNING** indicates a potential hazard associated with the use of this equipment. It calls attention to a procedure, practice, condition, or the like, which if not correctly performed or adhered to, could result in death or serious injury.



WARNING: This symbol and/or the use of the word **WARNING** indicates a potential hazard from **electrical shock**. It calls attention to a procedure, practice, condition, or the like, which if not correctly performed or adhered to, could result in death or serious injury.



CAUTION: This symbol and/or the use of the word **CAUTION** indicates a potential hazard associated with the use of this equipment. It calls attention to a procedure, practice, condition, or the like, which if not correctly performed or adhered to, could result in minor or moderate injury.



IMPORTANT: The use of the word **IMPORTANT** in this manual calls attention to a procedure, practice, condition, or the like, which if not correctly performed or adhered to, could result in incorrect performance of or damage to the equipment and may void the warranty.

1.3. Safety Precautions



WARNING: This instrument has not been designed to be intrinsically safe for use in areas classified as hazardous locations. For your safety, **DO NOT** use it in hazardous (classified) locations.



WARNING: Under no circumstances should the MZ-RD be operated without connection to a protective ground. Doing so poses a potential shock hazard and is also a violation of electrical safety standards applicable to this type of equipment.



WARNING: Do not operate this equipment in the presence of flammable liquids, vapors or aerosols. Operation of any electrical instrument in such an environment constitutes a safety hazard.



WARNING: Extreme care should be exercised when accessing the interior of the remote display. Only qualified electrical maintenance personnel should perform connections and adjustments. Always remove AC power before working inside the remote display's enclosure.



IMPORTANT: The protection provided by the remote display may be impaired if the remote display is used in a manner not specified by Bacharach, Inc. Modifications to this remote display, not expressly approved, will void the warranty.



IMPORTANT: In case of malfunction, do not continue to use this equipment if there are any symptoms of malfunction or failure. In the case of such occurrence, de-energize the power supply and contact a qualified repair technician or the nearest Bacharach Service Center. Use **ONLY** the provided knockouts for electrical and communication wiring. Drilling into the box will void the warranty.



WARNING: To clean the outside of the case use a **DRY CLOTH**. **DO NOT** use soap and water.



IMPORTANT: This device is designed for operation at or below an altitude of 6,562 ft (2,000 m). Do not operate this device above this altitude limit.

1.4. Communications Options

The MZ-RD features full two-way communications via an RS-485 interface. MODBUS RTU is the communication protocol standard. The instrument (P/N 3015-5138) can be connected to a Building Management System or it may be operated as a stand-alone system with Bacharach's gas monitors.

Please refer to the Appendix for a more complete discussion of communication protocols.

CHAPTER 2. INSTALLATION

2.1. Warnings and Cautions



WARNING: Explosion hazard! Do not mount the MZ-RD in an area that may contain flammable liquids, vapors or aerosols. Operation of any electrical equipment in such an environment constitutes a safety hazard.



WARNING: Electrical installation should be performed by a certified electrician, and should comply with all applicable NEC/CEC and local electrical safety codes.



WARNING: The AC power ground wire must first be connected to the monitor's ground stud. Under no circumstances should this monitor be operated without a protective ground. Doing so poses a potential shock hazard, and is also a violation of electrical safety standards applicable to this type of equipment.



WARNING: Shock hazard! Always disconnect AC power before working inside the monitor.



CAUTION: Drilling holes in the MZ-RD enclosure may damage the unit and will void the warranty. Please use provided knockouts for electrical connections.



CAUTION: The MZ-RD contains sensitive electronic components that can be easily damaged. Be careful not to touch or disturb any of these components.

2.2. Preliminary Inspection

The MZ-RD has been thoroughly inspected and tested prior to shipment from the factory. Nevertheless, it is recommended that the instrument be re-checked prior to installation. Inspect the outside of the enclosure to make sure there are no obvious signs of shipping damage. Loosen the four screws on the sides of the enclosure and remove the front panel. Visually inspect the interior of the display for loose components that may have become dislodged during shipment. If damage is discovered, please contact the nearest Bacharach Service Center for assistance.

2.3. Location of the Remote Display

The MZ-RD should be centrally located in the facility (preferably outside of the mechanical room) and should be easily accessible for visual monitoring and servicing. This is the “split architecture design” for safety of the operator.

Dirt, grease, and oils can adversely affect the operation of the MZ-RD. The MZ-RD should be installed out of direct sunlight in a clean, dry area that is not subject to temperature or humidity extremes. Installation in a mechanical room is acceptable provided reasonable environmental conditions exist. If there is a question, consider installing the unit outside of the mechanical room in a cleaner area of the facility.

The MZ-RD can be located up to 4500 feet (1372 m) from the furthest gas monitor. The MZ-RD is the main machine interface by which you can program the gas monitor, acknowledge alarms, and observe conditions inside the mechanical room. Note that there are two additional alarm relay contacts in the MZ-RD that can be programmed to alarm with “leak, spill, evacuate, fault or monitor on”.

2.4. Mounting Instructions

The MZ-RD should be installed plumb and level and securely fastened to a rigid mounting surface.

The enclosure utilizes keyhole mounting brackets designed for ¼ inch fasteners.

Locate the four screws as shown in the diagram below or by using the provided mounting template.

Allow the screw heads to protrude approximately 1/4" (6 mm).

Hold the unit flat against the mounting surface and allow it to slide down engaging the screw heads in the keyhole slots of the mounting brackets. Adjust the screws as necessary to hold the unit

MZ-RD Mounting Specs

securely against the mounting surface.

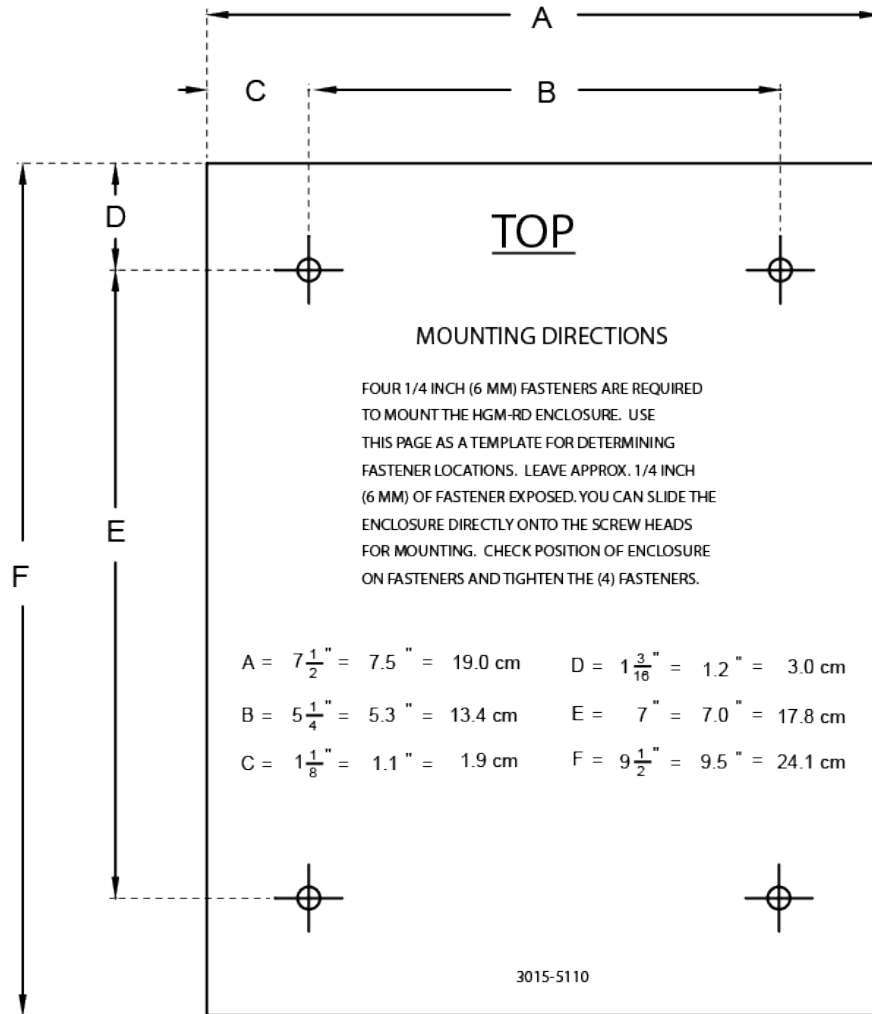

2.5. Interior Components

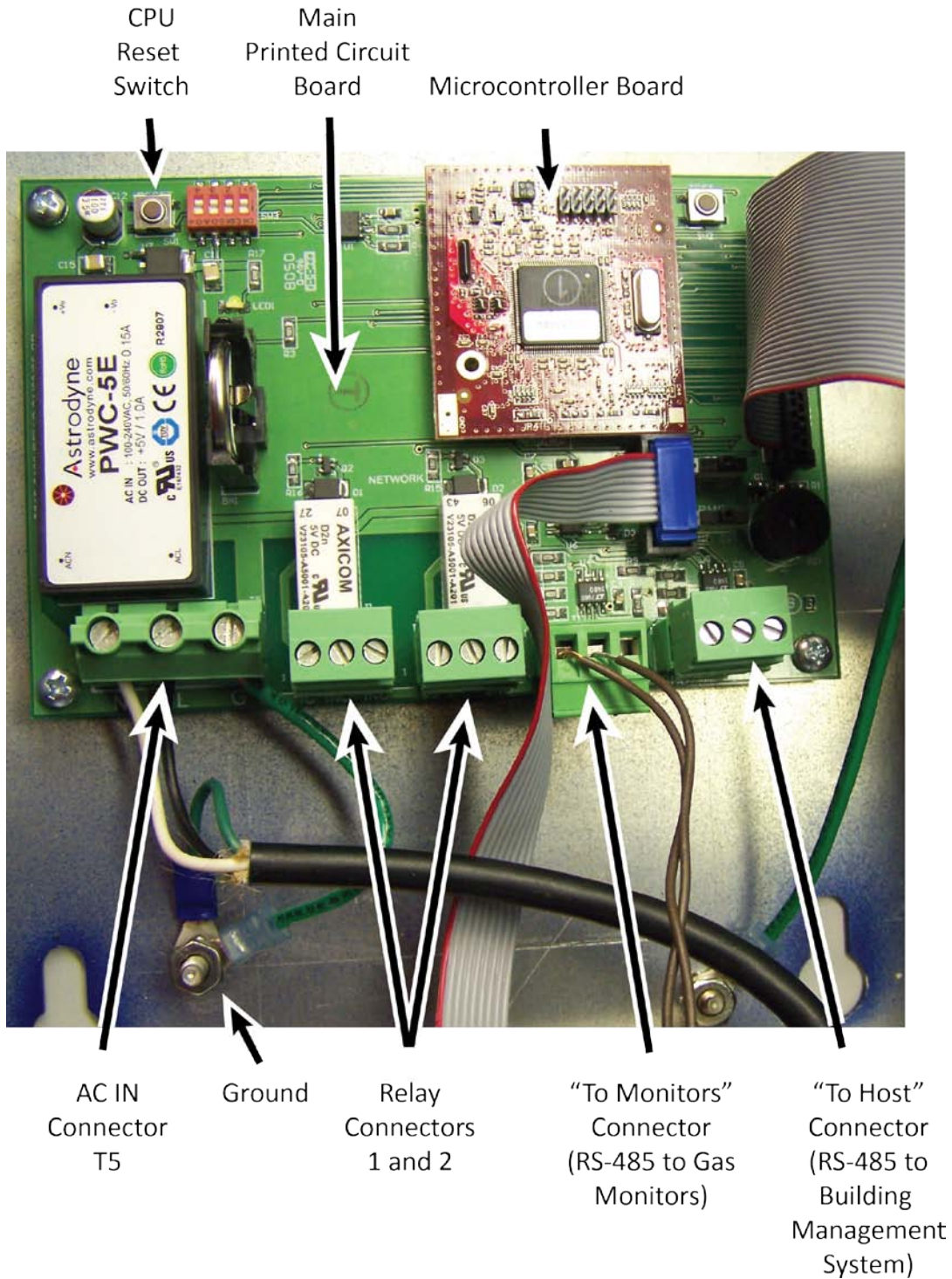

2.6. Electrical Wiring

Locate a convenient service knockout and install electrical conduit in the typical manner.

Locate the AC Input Terminals and Ground Stud on the inside of the unit. Secure the incoming AC power neutral (white/blue) and live (black/brown) wires to the LINE 1 and LINE 2 terminals.

Using the supplied crimp-on ring terminals, washers, and nuts, connect the incoming AC power ground wire (green w/ yellow stripe) to the unit's AC Input Ground Stud, and then install a separate wire between the ground stud and the GND terminal.



WARNING: Electrical installation should be performed by a certified electrician, and should comply with all applicable NEC/CEC and local electrical safety codes.



WARNING: Copper conductors for connection to supply mains must be made in accordance with NEC/CEC and local codes.



WARNING: The AC power ground wire must first be connected to the unit's ground stud. Under no circumstances should this monitor be operated without a protective ground. Doing so poses a potential shock hazard, and is also a violation of electrical safety standards applicable to this type of equipment.



CAUTION: Drilling holes in the MZ-RD enclosure may damage the unit and will void the warranty. Please use knockouts provided for electrical connections.

MZ-RD AC Input Power and Ground Connections



GROUND WIRE
TO ENCLOSURE DOOR

GREEN

Use supplied crimp-on ring terminal, washers, and nuts to connect AC input ground wire to Ground Stud as shown to meet approval agency requirements.

AC INPUT
GROUND WIRE

GREEN W/ YELLOW STRIPE

IMPORTANT!
AC input ground wire must be positioned on bottom of Ground Stud

GROUND STUD

A switch or circuit breaker rated 1.0 A, 250 VAC must be attached to the unit's AC power leads. This switch must also be located in close proximity to the monitor, and be in easy reach of the operator. This switch should also be clearly marked as the monitor's main AC disconnect device.

2.7. Communications Connections

2.7.1 MZ-RD Network

The MZ-RD is connected to the gas monitor using a shielded twisted pair instrument cable. The maximum distance between the furthest gas monitor and MZ-RD is 4500 feet (1372 m).

Use any of the remaining service knockouts to gain access to the interior of the unit. The RS-485 communication wiring between the gas monitor and MZ-RD must be connected in the following manner:

1. Locate the RS-485 connector in the gas monitor (See appropriate gas monitor manual).
2. Connect one lead of a twisted shielded pair to the "B" connection point; note the wire color.
3. Connect the second wire to the "A" connection point; note the wire color.
4. Connect the ground to the "GND" connection point

Locate the RS-485 connector marked "TO MONITORS" in the MZ-RD. This connector is located on the bottom of the MZ-RD PC board, second from the right. Run the wire to the MZ-RD and connect the twisted shielded pair to the RS-485 TO MONITORS connector using the same color code as used on the gas monitor.

RS-485 to HOST Connector

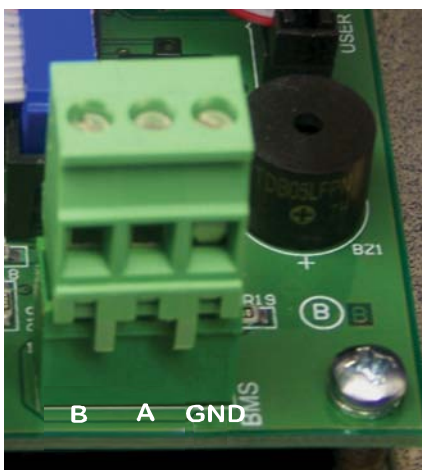

2.7.2 Integration with Building Management System

A second RS-485 connector allows a Building Management System to "talk" to the gas monitor network through the MZ-RD. The connection is established using a shielded twisted pair cable.

Use any of the remaining service knockouts to gain access to the interior of the MZ-RD. Locate the RS-485 connector marked "TO HOST" and remove it from the circuit board. Secure the wire leads to the connector in the orientation as displayed on the board. Check to make sure the polarity matches the wiring to the Building Management System. When connections are secured, carefully plug the connector back onto the circuit board.

2.8. Connecting External Alarms

2.8.1 Overview

Two SPDT relays are available for the connection of external alarm devices. These alarms are useful for alerting the user to global conditions anywhere on the network. Each relay can be programmed to respond to alarm, fault, or ready conditions.

2.8.2 Connection

Use the AC conduit or any of the remaining service knockouts to gain access to the interior of the MZ-RD. Locate the relay connectors and remove them from the circuit board. Secure the wire leads to the connectors orienting them as shown in the diagram below. After connections are secured, carefully plug the connectors back onto the circuit board.

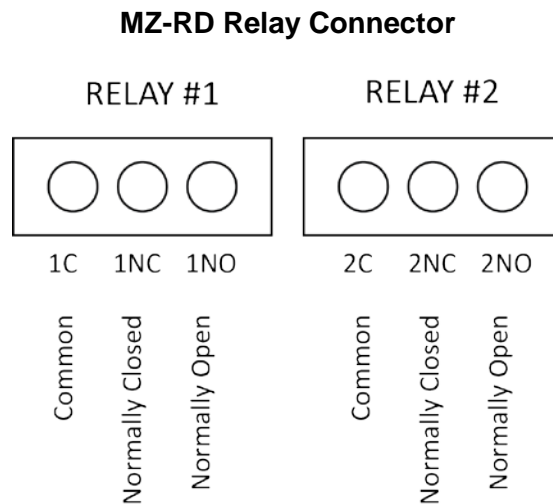

NOTE: Each relay can be connected as normally open (NO), or normally closed (NC).



NOTE: Power for the external alarms can be tapped off the AC IN connector.



NOTE: The relay contacts are rated 2A at 250VAC (inductive) and 5A at 250VAC (resistive).

CHAPTER 3. OVERVIEW

3.1. General

The MZ-RD displays comprehensive information about the gas monitor network status and enables complete programming control of all system operations.

When first powered up, a splash screen appears indicating the firmware revision number. After a brief moment the System Screen is displayed.

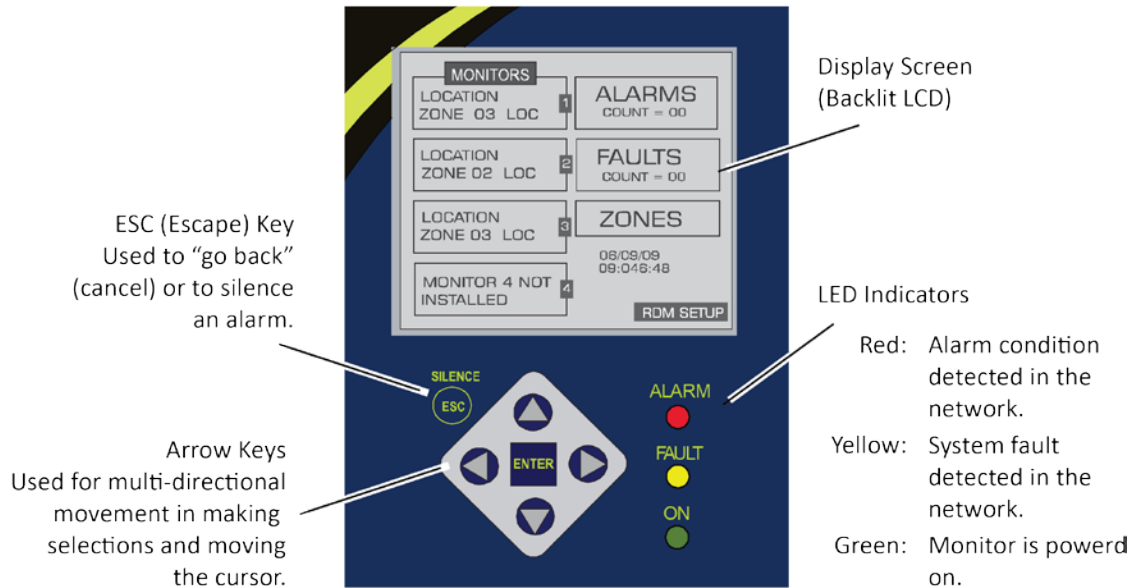

The System Screen

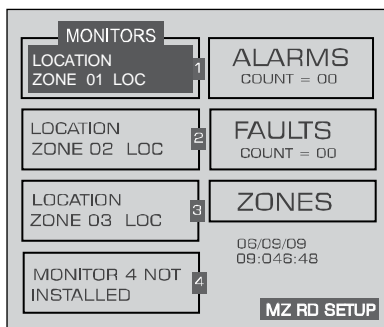

After the System screen is displayed, press the ENTER key. The Monitor 1 location block on the screen will highlight and begin to flash.

With Monitor 1 selected,

1. Press ENTER to access other screens that contain information and setup criteria for Monitor 1.
2. Use the Arrow keys to make data entry selections on each screen.
3. Press the ENTER key to accept the entries or use ESC to cancel and return to the previous screen.

4. When programming is completed, use the ESC key to return to the System screen.

To access Monitors 2, 3 or 4, use the down Arrow key. Access information for these monitors in the same manner as described above for Monitor 1.

In like fashion, use the Arrow keys to navigate through the screens and the ENTER key to make selections for ALARMS, FAULTS, ZONES, the date/time or MZ-RD SETUP.

Some of the screens you will access will require data entry, such as the date/time setup. These screens will appear with a character selected, as displayed below. Use the up/down Arrow keys to scroll through the characters provided for that character's place. Use the left/right Arrow keys to move the cursor on the text line. When all character selections for the screen are completed, press ENTER to accept the entries.



3.2. System Programming

3.2.1. Setup Parameters

Before working with the gas monitor network, several global parameters must be defined. Most of these are entered in the **MZ-RD Setup Screens** or via the **PC software**. Parameters must also be defined for each gas monitor connected to the network. These settings serve to identify each monitor and define how they operate. These are entered in the **Setup Screens**. Finally, parameters must be defined for each individual monitoring zone. These are entered in the **Zone Setup Screens**.

3.2.2. Password Protection

The MZ-RD can be password protected to prevent the unauthorized editing of setup parameters. When password protection is enabled, an operator may still navigate between screens to observe settings or monitor network status. The password can be alpha-numeric.

The unit is shipped with password protection OFF. Entering a password in the **MZ-RD Setup Screen #1** enables password protection. After protection is enabled, the user will be prompted to enter the password when an attempt is made to edit a setup parameter.

After entering the password, a 30 minute time period will be allowed for entries, after which the user will again be prompted to re-enter the password.



IMPORTANT: Make note of your password and save it.

3.3. Setup Programming

3.3.1. Setting the Clock

On the **System Screen**, access the **Clock setup screen**.

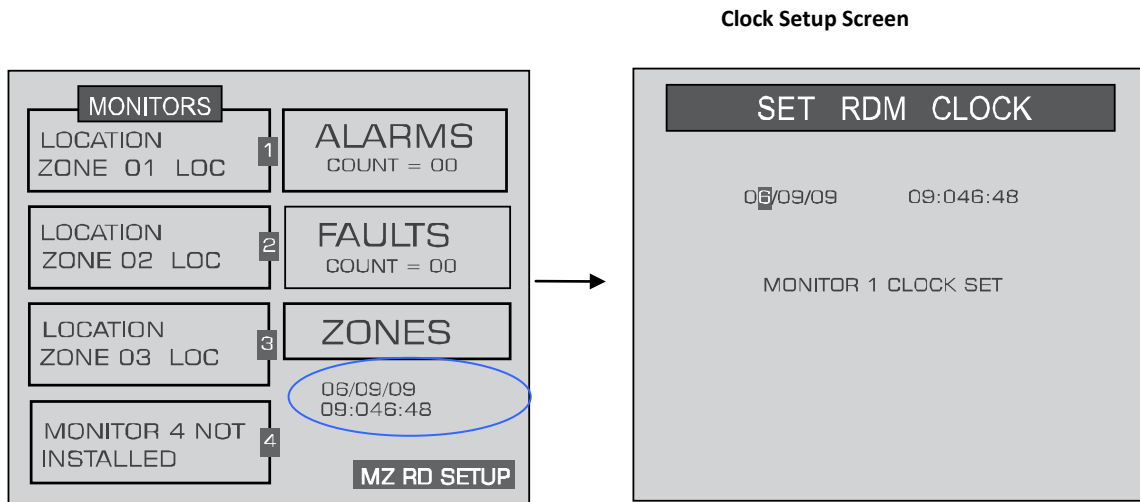

Use the cursor keypad to modify the field value and accept your entries. When editing is complete, do one of the following:

- Select the SET RD CLOCK option to synchronize all gas monitors to the current date/time setting.
- Select the ESC option to cancel all edits and revert to the previous setting.
- Press ENTER to accept the current date/time setting.

3.3.2. Navigating to the 1st MZ-RD Setup Screen

On the **System Screen**, select MZ-RD SETUP to access the **MZ-RD Setup Screen #1**.

MZ-RD Setup Screen #1

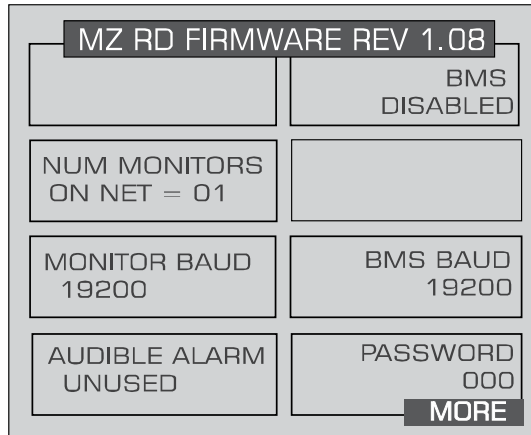
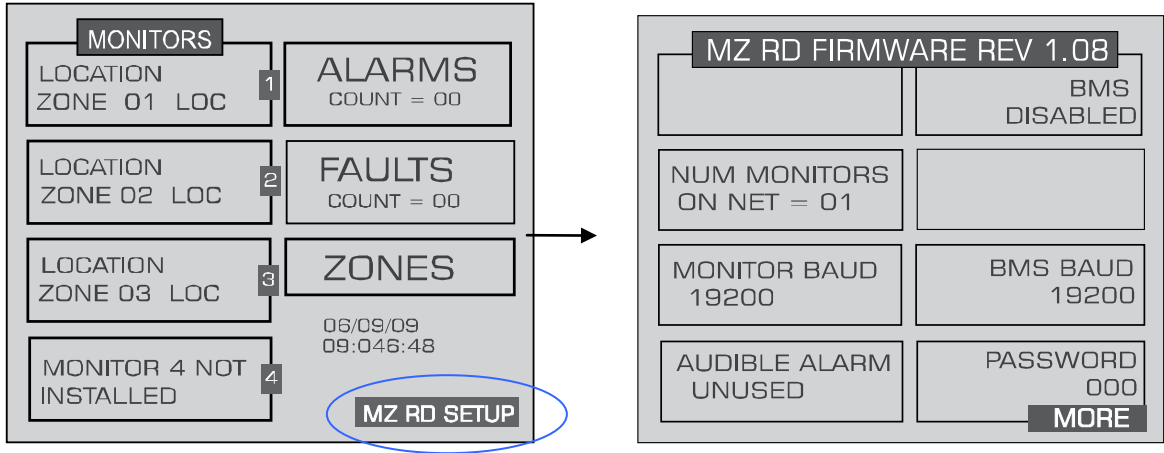

3.3.3. Num Monitors on Net

This is the number of gas monitors connected to the MZ-RD.



NOTE: When first powered up, the MZ-RD will automatically detect all gas monitors on the network with unique node addresses. Refer to Gas Monitor Node Address.

3.3.4. Monitor Baud

This is the baud rate of all gas monitors connected to the network. The default value is 19200.



NOTE: All gas monitors on the network must have the same baud rate.

3.3.5. Audible Alarm

This parameter selects the function of the MZ-RD’s internal audible alarm. Select Unused, Monitor on, Evacuate, Spill, Leak, Fault, or Alarm.

3.3.6. BMS

This enables or disables the connection to a Building Management System. When selected, use the UP/DOWN cursor keys to toggle the setting.

3.3.7. BMS Baud Rate

This is the baud rate of the Building Management System.

3.3.8. Password

This field is used to define a system password. The default setting is 000, which provides no password protection.

3.3.9. Navigating to the 2nd MZ-RD Setup Screen

On **MZ-RD Setup Screen #1**, select MORE to access **MZ-RD Setup Screen #2**. Select BACK to return to **MZ-RD Setup Screen #1**.

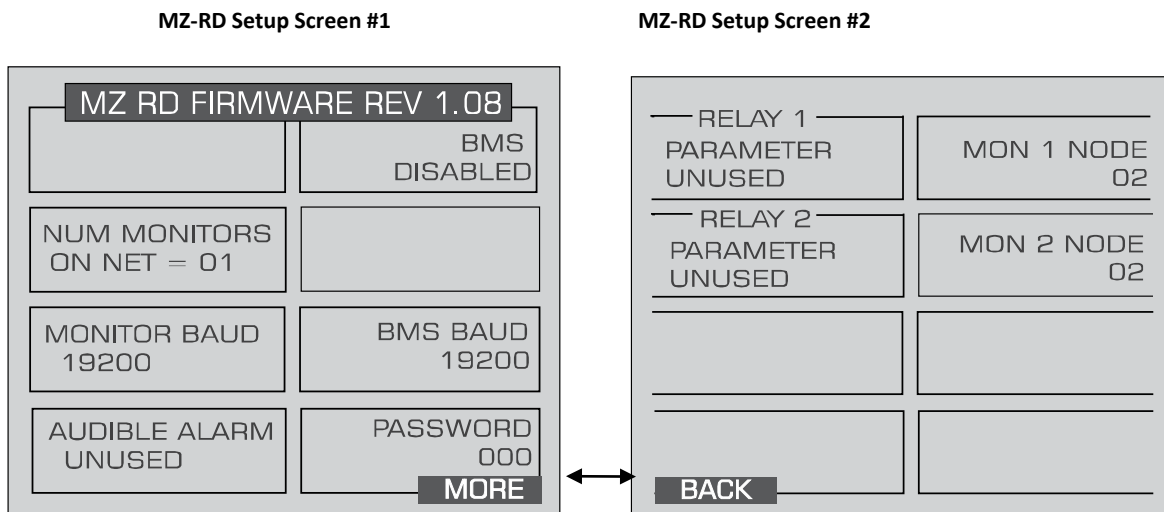

3.3.10. Setting Relay Parameters

This setting determines the function of relays 1 and 2 mounted inside the MZ-RD unit. Select Unused, Monitor On, Evacuate, Spill, Leak, Fault, or Alarm.



NOTE: “Monitor On” means that the RD responds only to critical faults (i.e., any fault that stops the units from monitoring, which includes lost communications with the MZ).

3.3.11. Node Address

This value is the node address from 1 to 15 assigned to each gas monitor which is on the network. These values must match the settings on each gas monitor.

3.3.12. Navigating to the 1st and then 2nd Monitor Setup Screen

From the **System Screen**, select the Multi-Zone unit you wish to set up to access that unit's **Monitor Setup Screen #1**.

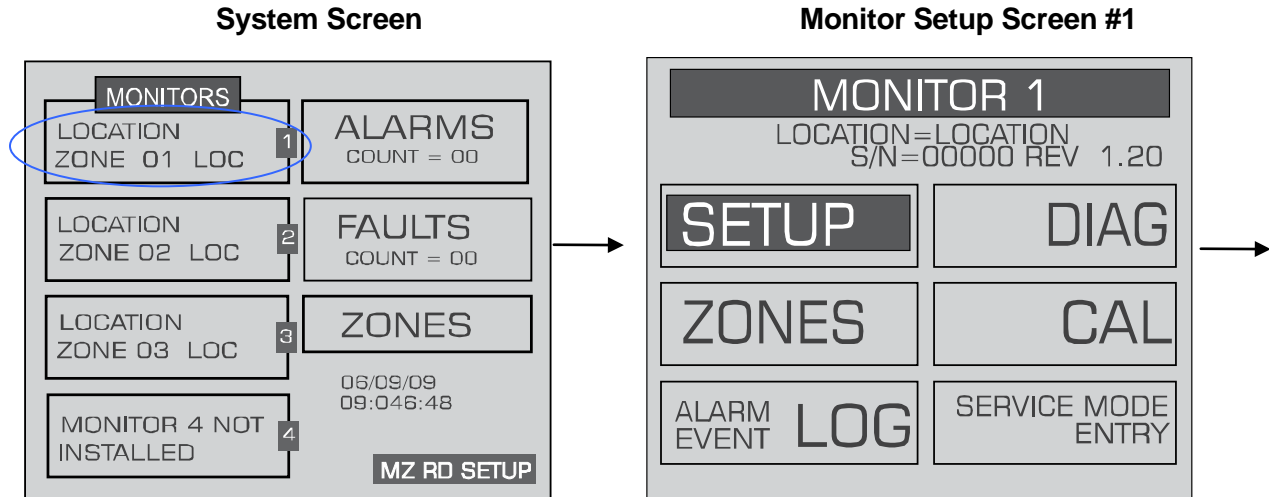

On **Monitor Setup Screen #1**, select the **SETUP** option to go to **Monitor Setup Screen #2**. To return to the **System Screen**, press **ESC**.

Monitor Setup Screen #2

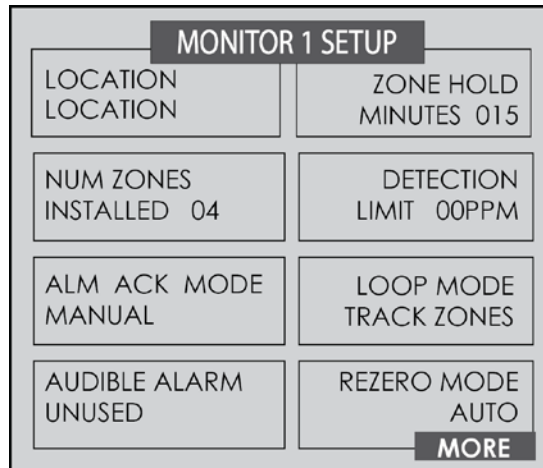

NOTE: For description or information on changing these settings please refer to the appropriate gas monitor instruction manual.

3.3.13. Navigating to the 3rd Monitor Setup Screen

From **Monitor Setup Screen #2**, select the **MORE** option to go to **Monitor Setup Screen #3**. Select the **BACK** option to return to **Monitor Setup Screen #2**. To return to the **System Screen**, press **ESC**.

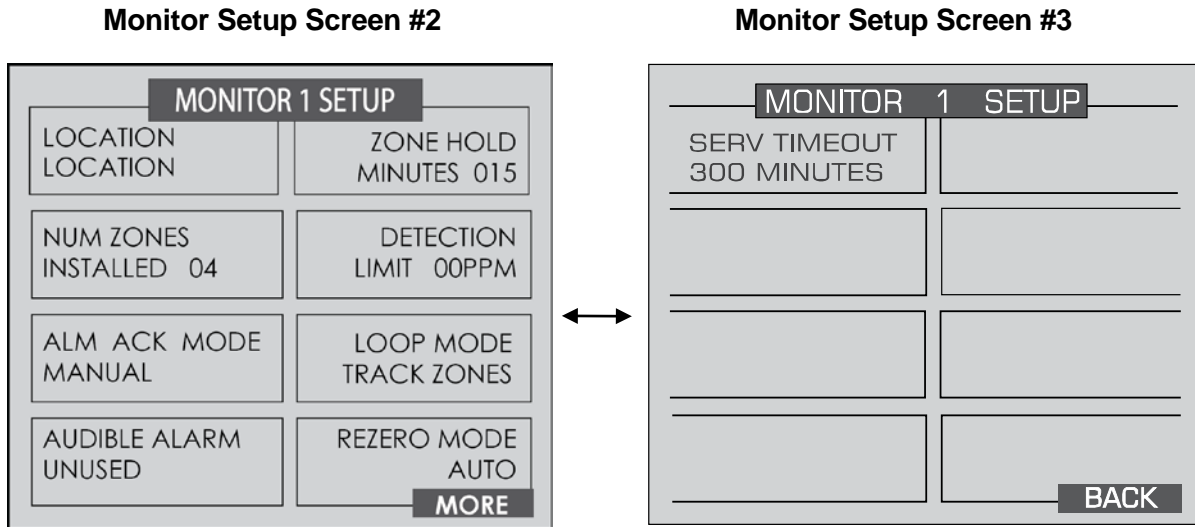

NOTE: For description or information on changing these settings please refer to the appropriate gas monitor instruction manual.

3.4. Zone Setup Programming

3.4.1. Navigating to the 1st Zone Setup Screen

From the **System Screen**, access the Monitor screen for the selected zone. On the Monitor Screen, select ZONES.

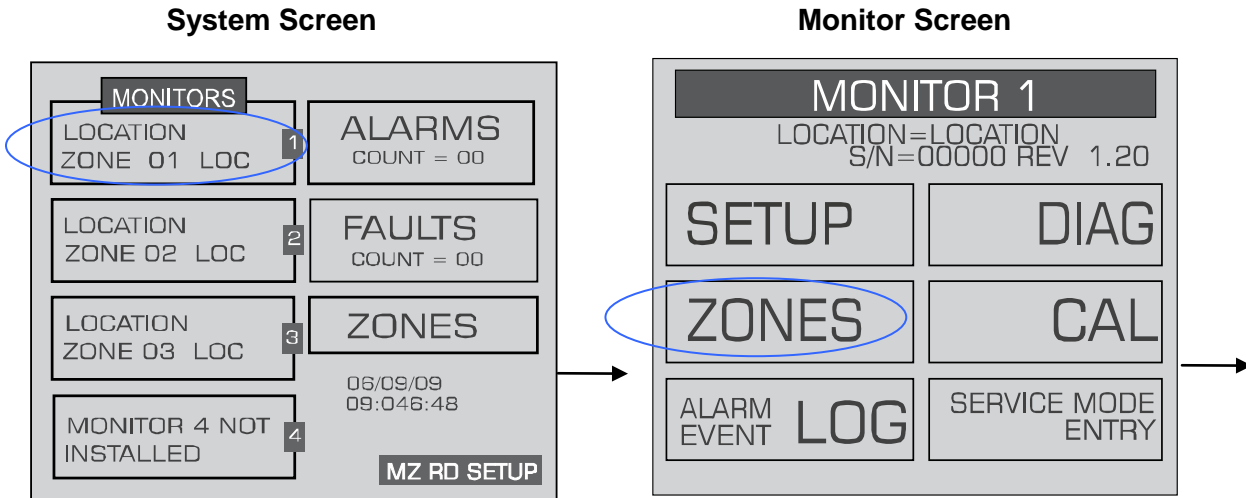

The **Zone Setup screen** will be displayed. To return to the **System Screen**, press ESC.

Zone Setup Screen #1

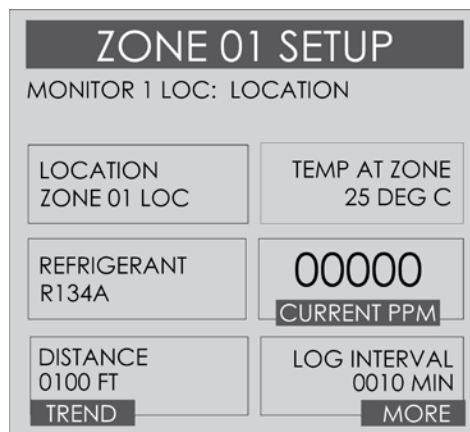

NOTE: For description or information on changing these settings please refer to the appropriate gas monitor instruction manual.

3.4.2. Navigating to the 2nd Zone Setup Screen

On **Zone Setup Screen #1**, select **MORE** to access **Zone Setup Screen #2**. Select **BACK** to return to **Zone Setup Screen #1**. To return to the **System Screen**, press **ESC**.

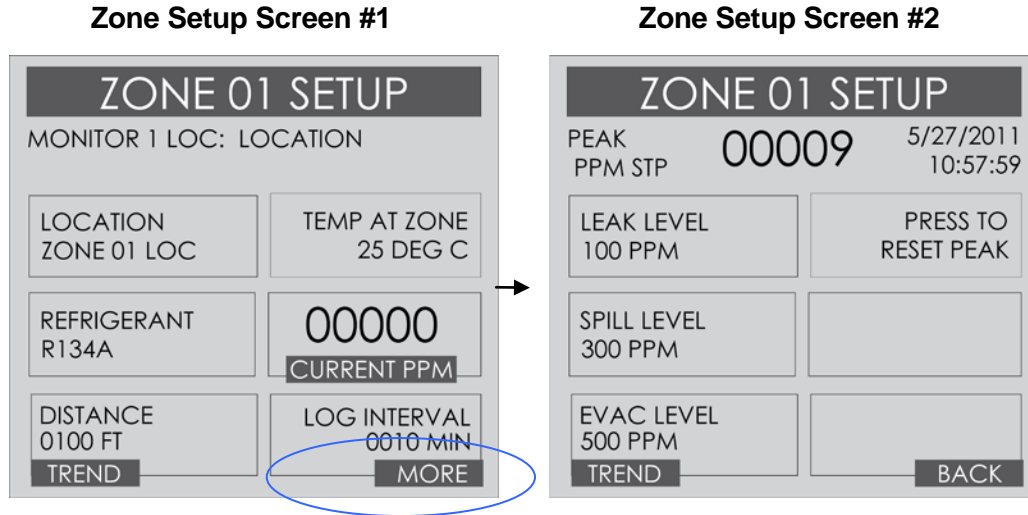

NOTE: For description or information on changing these settings please refer to the appropriate gas monitor instruction manual.

3.4.3. Navigating to the Trend Screen

On **Zone Setup Screen #2**, select the **Trend** option on the bottom left side to access the **Trend** screen.

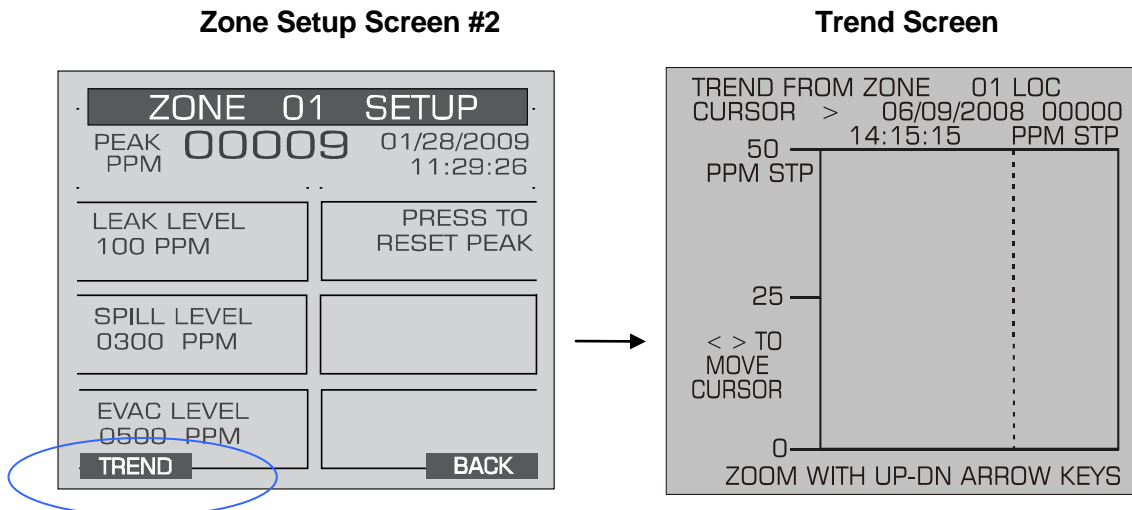

The trend graph opens with the cursor located over the most recent data point. Use the LEFT/RIGHT cursor keys to move the cursor to different data points. Holding a key down will cause the cursor to move rapidly across the screen. As you move the cursor position, the date and time of that reading, along with the ppm value, are displayed at the top of the screen above the graph. The trend graph is automatically scaled to accommodate the largest ppm value displayed. The ZOOM OUT and ZOOM IN options allow you to adjust the vertical scale of the graph.

The trend data is stored on a first-in, first-out basis. After 100 trend values have been stored the 101st value will replace the first value stored. Therefore, in normal operation, when entering trend mode the cursor will be located at the most recent data point. The data points to the left of the initial cursor location will be the next most recent. The data point to the right will be the oldest data point in the buffer and will be over written by the next data point.

CHAPTER 4. GENERAL OPERATION

4.1. Functional Overview

Normally each gas monitor will sequentially perform measurements on its active zones without user input. The total time it takes a gas monitor to complete a measurement cycle is directly proportional to the number of active zones and the physical length of the air lines. Monitors linked together on a network operate independently of each other and consequently complete their respective measurement cycles at different rates.

The MZ-RD operates by polling the network approximately once every 12 seconds to determine the current status of the gas monitors. If more than one gas monitor is connected to the network, it will sequentially poll each monitor for its status. This means that the more complicated the network, the longer it will take the MZ-RD to update the status information for all zones.

To display all the zones being monitored, go to the **System Screen** and press the ZONES key.

4.2. The Zone Screen

The top level **Zone Screen** provides a summary view of zone activity across the network. Each screen displays information from a single Multi-Zone monitor as indicated at the top of the display. Each screen can display information for up to 8 zones, and depending on the configuration of the system, there can be up to two screens for each Multi-Zone. Use the UP/DOWN cursor keys or the NEXT key to scroll the screen display.

Each box displays the zone location and the last ppm measurement. A blinking box indicates that a measurement is currently being taken in that location. An inverse flashing box indicates an alarm condition in that zone.

Zone Screen

| MONITOR 1 LOCATION | |
|----------------------|--|
| ZONE 01 LOC 0 PPM | |
| ZONE 02 LOC 0 PPM | |
| ZONE 03 LOC 0 PPM | |
| ZONE 04 LOC 0 PPM | |
| ALARMS | |

To further investigate the status of any zone, select the zone and press the ENTER key. That monitor's **Zone Setup Screen #1** will be displayed.

4.3. Alarm Conditions

When an alarm condition is detected anywhere on the network the red alarm will glow. Additionally, an external alarm device may activate and an audible alarm may sound if those features have been enabled.

An inverse flashing box indicates an alarm condition in the affected zone. If manual acknowledgement is required by the system setup, the alarm must be acknowledged by pressing the left arrow key while this screen is displayed. If the right arrow key is pressed, setup information for the alarm screen will be displayed

Zone Alarm Screen

| | |
|----------------------------|--------------------------|
| MONITOR 1 ZONE 02 LOCATION | |
| ZONE 02 | LOC |
| 00543 CONC NOW | R134A GAS TYPE |
| 00142 | 02/13/2009 16:35:01 |
| PPM PEAK ALARM | PEAK TIME ALARM TIME |
| EVACUATE | 02/13/2009 ALARM TIME |
| << = ACK | >> = SETUP |

If the current **Zone Screen** appears normal, scroll through the displays using the NEXT/BACK keys or the UP/DOWN cursor keys until you locate the affected zone. To further investigate the status of an affected zone, select the zone and press the ENTER key. That **Zone's Setup Screen #1** will be displayed. You may also select ALARMS to access the **Alarm Summary Screen**. Refer to *Alarms* on page 24 to learn more about responding to alarms.

4.4. Fault Conditions

If a system malfunction occurs, the yellow FAULT LED will glow. Additionally, an external alarm device may activate and an audible alarm may sound if those features have been enabled.

From the top level **Zone Screen**, make sure no zones are selected and press ENTER to go to the **System Screen** and then press the FAULTS key to access the **Fault Screen**. Refer to *System Faults* to learn more about responding to system faults.

Fault Screen

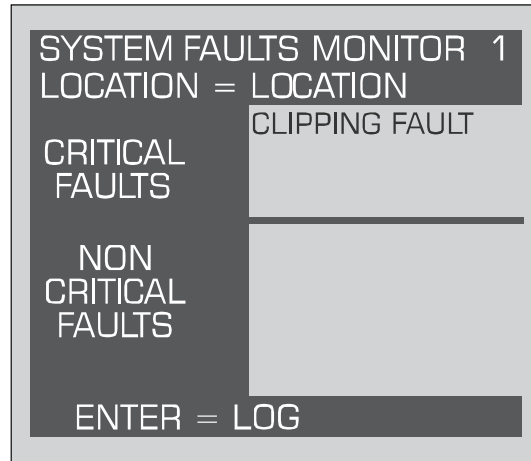

4.5. The System Screen

The **System Screen** provides a summary view of the entire gas monitor network. The boxes on the left side of the screen indicate the status of each gas monitor. This includes the name, the current zone, and if fault or alarm conditions are present on the network.

System Screen

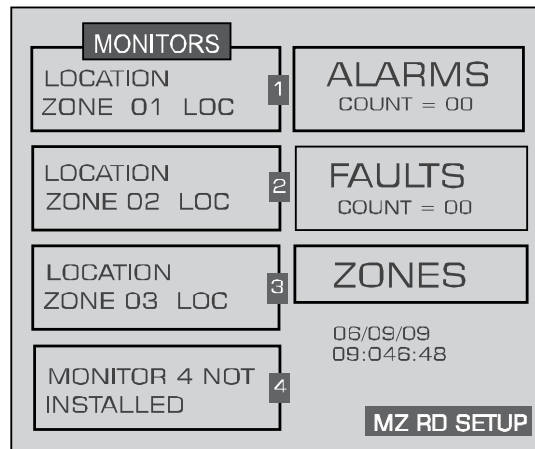

4.5.1. Alarm Conditions

When an alarm condition is detected anywhere on the network the red ALARM LED will glow. Additionally, an external alarm device may activate and an audible alarm may sound if those features have been enabled.

The ALARMS box in the upper right hand corner of the screen will blink and the count value will change to indicate the total number of alarm conditions on the network. To investigate an alarm, select the ALARMS option to go to the Alarm Summary Screen. Refer to *Alarms* on page 24 to learn more about responding to alarms.

System Screen (Alarm Mode)

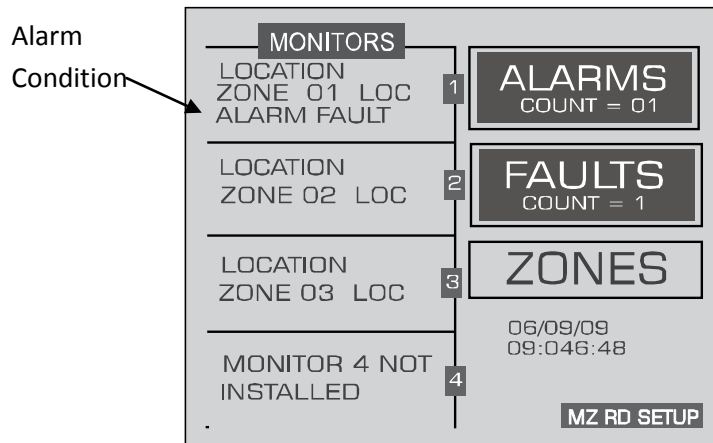

4.5.2. Alarm Log

From the **System Screen**, access the gas monitor you wish to view.

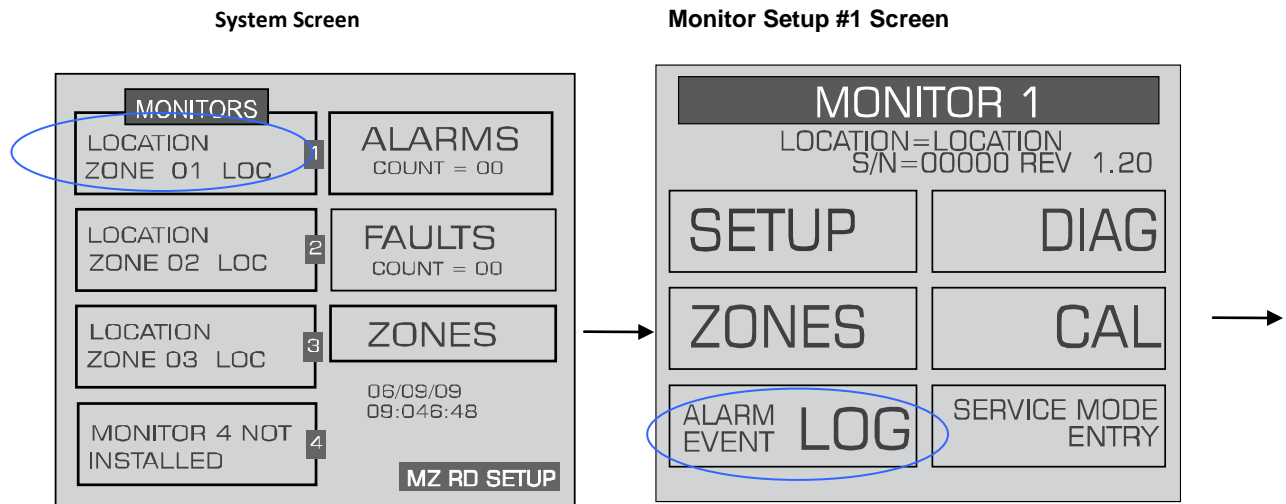

Select the ALARM EVENT LOG option and press ENTER to display the **Alarm Log Screen**.

Alarm Log Screen

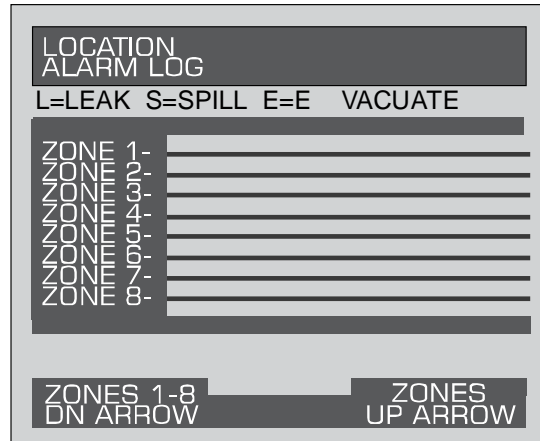

Use the key pad left/right keys to move through the log.

Use the LEFT/RIGHT and UP/DOWN cursor keys to move through the log.

The Alarm log shows the last **20 alarm** events. An alarm event is the occurrence of any alarm, any change in alarm level, or the clearing of any alarm. The alarm level is indicated by an L (leak), S (spill), or E (evacuate). The time and date of the alarm are displayed when the cursor is placed over the alarm.

4.5.3. Fault Conditions

If a system malfunction occurs, the yellow FAULT LED will glow. Additionally, an external alarm device may activate and an audible alarm may sound if those features have been enabled.

The FAULTS box on the right of the screen will blink and then counts the number of gas monitors on the system with a fault. To investigate a fault, select the FAULTS option to go to the **Fault Screen**. Refer to *System Faults* to learn more about responding to system faults.

System Screen (Fault Mode)

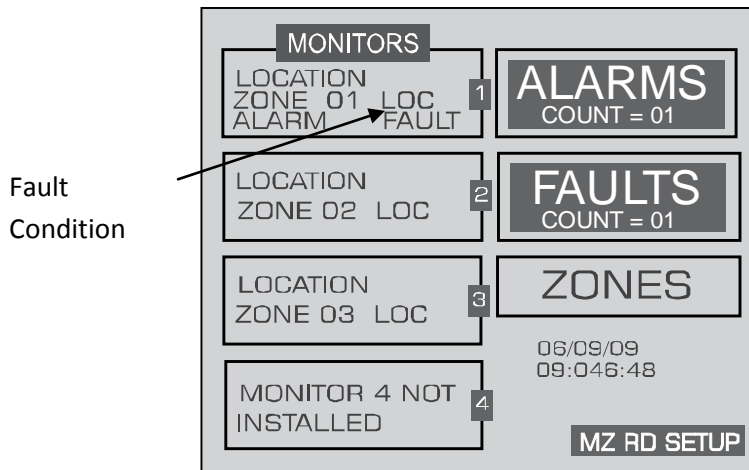

4.6. Alarms

4.6.1. Functional Overview

If the ppm level for any zone exceed its designated spill, leak, or evacuate thresholds, an alarm condition will be created. Once the gas monitor completes a measurement cycle in the affected zone the alarm condition will be indicated. At that time the red ALARM LED on the gas monitor will glow. Additionally, an external alarm device may activate and an audible alarm may sound if those features have been enabled.

The next time the MZ-RD polls the affected monitor, its red ALARM LED will glow. Additionally, an external alarm device may activate and an audible alarm may sound if those features have been enabled.

The alarm condition may or may not have to be acknowledged for the system to return to normal operation.

4.6.2. Responding to Alarms

There are two screens from which an operator can respond to alarms:

- From the **System Screen**, select the ALARMS field to go to the **Alarm Summary Screen**.
- From the top level **Zone Screen** select the ALARMS field at the bottom of the display screen to go to the **Alarm Summary Screen**.

Alarm Summary Screen

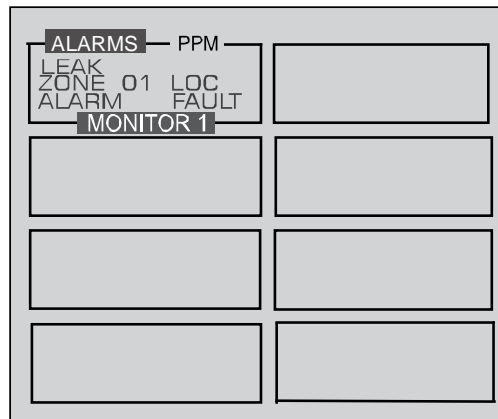

The **Alarm Summary Screen** displays a list of all alarm conditions pending across the network. The screen is divided into 8 boxes, and each box represents a single alarm. If more than 8 alarms are pending additional pages can be displayed by pressing the MORE key.

Each box displays the zone number, zone name, and the current ppm reading. A flashing box indicates an alarm that has not been acknowledged. A static box represents an alarm that has been acknowledged but has not yet been cleared from the system.

4.6.3. Alarm Detail Screen

To further investigate an alarm, select the alarm on the Alarm Summary screen, then press ENTER to access the **Alarm Detail Screen**.

Alarm Detail Screen

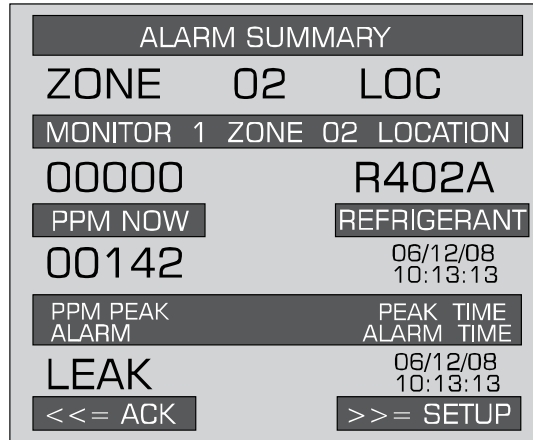

The **Alarm Detail Screen** displays more comprehensive information about the nature of the alarm including:

- Complete location information
- Refrigerant and current ppm
- Peak ppm and peak time
- Type of alarm, alarm time, and date

This screen provides the following three options at the bottom of the display:

- ACK (<<)** Acknowledges the alarm as described in the next section
- ESC** Returns to the **Alarm Summary Screen**
- SETUP (>>)** Navigates to **Zone Setup Screen #1**, which enables you to review the zone setup parameters and access the **Trend Screen**

4.6.4. Acknowledging Alarms

Each pending alarm may require, depending upon selected alarm mode, acknowledgment before the system returns to normal operation (refer to *Alarm Ack Mode*). To acknowledge an alarm, navigate to the **Alarm Detail Screen** and press the ACK key as previously described. You will then be returned to the **Alarm Summary Screen** and the box associated with that alarm will no

longer be blinking, indicating that the alarm has been acknowledged. Repeat this procedure to acknowledge any remaining alarms.

Alarm Summary Screen (Acknowledge Mode)

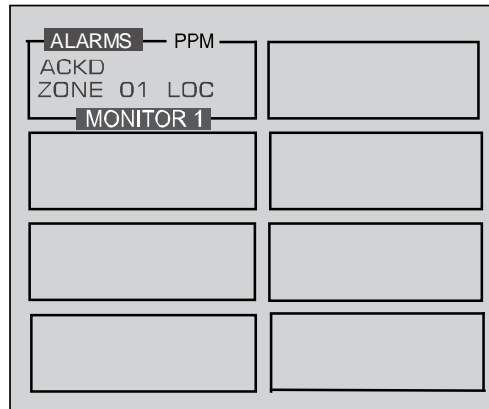

When all the alarms associated with a given gas monitor are acknowledged, its RED LED will turn off and any external alarms connected to the gas monitor relays will de-activate. All pending alarms across the entire network must be acknowledged before the MZ-RD returns to normal operation. When that occurs, its RED LED will turn off and any associated external alarms connected to the MZ-RD relays will de-activate.

The system will continue to generate new alarms if ppm values above the alarm thresholds are detected.

4.7. The Trend Screen

4.7.1. Overview - Log Interval

The gas monitor retains a data log of 100 measurements for each zone. The log interval is the number of minutes from 1 to 1440 between each log point. This parameter can be changed from **Zone Setup Screen #1**.

The default setting for this parameter is 1440 minutes (24 hours). If the log interval time is set to 0, then a measurement is recorded in the trend log after *every measurement cycle*. Therefore, after the trend log is filled it will contain the last 100 measurement points for a zone. If you want the data logged less frequently you should increase this value. It is important to remember that cycle time is dependent on many factors, including the number of zones being monitored, input line length, and the run zeroing mode selected. Before changing this value it may be useful to first review the log data using the **Trend Screen** to determine the nominal cycle time.

4.7.2. Navigating to the Trend Screen

Access the **Trend Screen** from the **Zone Screen** as follows:

From the top level **Zone Screen** press the key adjacent to the zone you wish to work with to first display its **Zone Setup Screen #1**. Then press the TREND key at the bottom of the display to go to the **Trend Screen**.

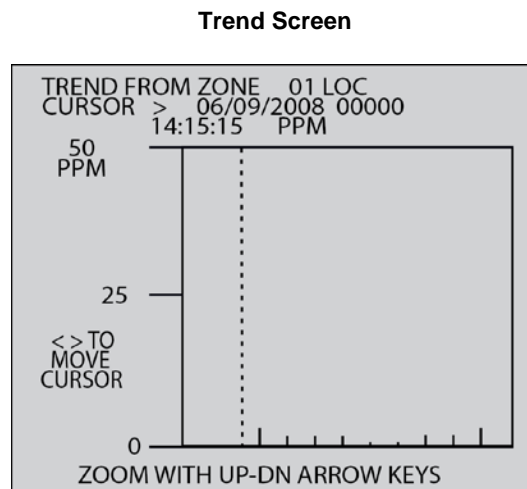

The trend graph opens with the cursor located over the most recent data point. Use the LEFT/RIGHT cursor keys to move the cursor to different data points. Holding a key down will cause cursor to move rapidly across the screen. As you move the cursor position, the date and time of that reading, along with the ppm value, are displayed at the top of the screen above the graph. The trend graph is automatically scaled to accommodate the largest ppm value displayed. The ZOOM OUT and ZOOM IN options, located in the bottom corners of the screen, allow you to adjust the vertical scale of the graph.

The trend data is stored on a first-in, first-out basis. After 100 trend values have been stored the 101st value will replace the first value stored. Therefore, in normal operation, when entering trend mode the cursor will be located at the most recent data point. The data points to the left of the initial cursor location will be the next most recent. The data point to the right will be the oldest data point in the buffer and will be over written by the next data point.

4.8. System Faults

4.8.1. Functional Overview

If a system malfunction occurs, the gas monitor will detect the problem and cause its yellow FAULT LED to glow. Additionally, an external alarm device may activate and an audible alarm may sound if those features have been enabled.

The next time the MZ-RD polls the affected monitor its yellow FAULT LED will also glow. Additionally, an external alarm device may activate and an audible alarm may sound if those features have been enabled.

Depending on the nature of the fault, the gas monitor may or may not continue to operate normally. Under a non-critical fault condition, the gas monitor will continue to measure and log data, but some peripheral functions may be compromised. Under a critical fault condition, action

is required for the gas monitor to operate normally. The table on the following page lists the various fault conditions and explains what action should be taken to correct the problem.

4.8.2. Navigating to the Fault Screen

On the **System Screen**, select FAULTS to access the **Fault Screen**.

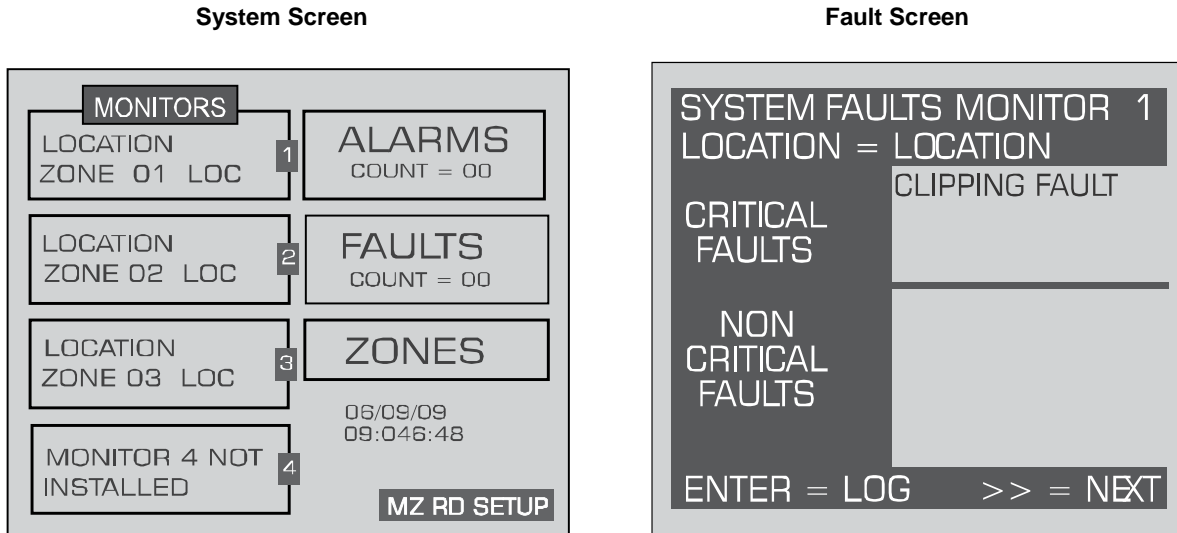

4.8.3. Critical Faults

- **NO FLOW ON ZONE** – On the **System Screen**, select ZONES. The **Zone Screen** will display a “NO FLOW” message in each individual zone affected. Check for a blockage in the air sample line or at the line end filter. After the blockage has been cleared, the gas monitor will return to normal operation after the zone has been sampled. **NOTE:** *This may take several minutes since it is dependent upon how many zones there are and their lengths.* The gas monitor will clear the fault the next time it polls the effected zone and the MZ-RD will return to normal operation the next time that it polls the gas monitor.
- **NO FLOW ON PURGE** – Check the purge line for a blockage. Verify that the length of the purge line and exhaust line do not exceed 300 feet (91 m) in length.
- **NO FLOW DETECTED** – Check for proper pump operation. Check the water trap – drain if necessary.
- **CLIPPING FAULT** – The detector voltage may be out of tolerance. Check the **Diagnostic Screen** for the DET voltage, AVE voltage and ZERO voltage. Call the factory with this information for further instructions.
- **REZERO VOLT TOL** – The detector output voltage is out of tolerance. Check the **Diagnostic Screen** and contact the factory for assistance.
- **TRIGGER FAULT** – No trigger from IR source pulser. Contact factory with all information from the DIAGNOSTIC SCREEN for farther instructions.

4.8.4. Non Critical Faults

- **BOX TEMP FAULT** – Enclosure’s internal temperature is outside normal range (or IR sensor has failed). Check the installation to verify that the monitor is not being subjected to extreme temperatures. Verify that the ventilation holes are not obstructed. Check the **Diagnostic Screen** for the ZERO temperature, BNCH temperature and BOX temperature. Call the factory with this information for further instructions.
- **BENCH TEMP FAULT** – IR sensor is outside of normal operating range (or sensor has failed). Check the installation to verify that the monitor is not being subjected to extreme temperatures. Check the **Diagnostic Screen** for the ZERO temperature, BNCH temperature and BOX temperature. Call the factory with this information for further instructions.
- **PRESSURE SENSOR** – Manifold pressure is outside normal operating range (or sensor has failed). Check the **Diagnostic Screen** record ALL data. Call the factory with this information for further instructions.
- **LOOP FAULT** – This would only be displayed if the dual 4-20 mAdc option was installed and one or both current loops are open. Check the wiring to load/monitoring circuit on both 4-20 mA loops.
- **CONFIG FAULT** – There is an error in **Monitor Setup Screen #2** – Number Zones Installed field, or in **MZ-RD Setup Screen #1** – Number of monitors on Network field. Check that the number of zones installed for each unit and the number of units on the network are properly programmed. Check to ensure that the manifold solenoid cable connector in each unit is securely fastened to its terminal connector. Check for an illegal parameter. If necessary, reset to the factory default settings.

4.8.5. Reset to Factory Default Settings



IMPORTANT: Performing this function deletes all program parameters, alarms, faults, trends and log files.

Resetting a Multi-Zone

1. Press and hold down the UP and DOWN arrow keys on the MZ monitor.
2. Cycle AC power OFF then ON.
3. Hold the keys until the second beep is heard.
4. The screen will indicate “This unit has been reset to factory default conditions”.
5. Release the keys.
6. Reprogram the MZ as described in this manual.

Resetting the MZ-RD – Occasionally it will be necessary to rest the MZ-RD to its factory default settings.

1. Press and hold down the UP and DOWN arrow keys on the MZ monitor.
2. Cycle AC power OFF, then ON;
3. Release the keys after the second beep is heard.

4.8.6. Clearing System Faults

If the fault condition is associated with a gas monitor, the monitor will return to normal operation soon after the problem is corrected. At that time the YELLOW LED will turn off and any external alarms connected to the monitor’s alarm relays will also turn off. The MZ-RD will return to normal operation the next time it polls the affected gas monitor.

Once the system malfunction has been corrected it may take some time for the fault condition to clear completely. If the fault is associated with a specific zone, the gas monitor must first cycle back to the affected zone before it returns to normal operation. At that time the YELLOW LED will turn off and any external alarms connected to the monitor’s alarm relays will also turn off. The MZ-RD will return to normal operation the next time it polls the affected monitor.

4.8.7. Viewing Fault Log

A data log of the last 20 fault conditions is retained in memory. From the **Fault Screen** press ENTER to display the fault log.

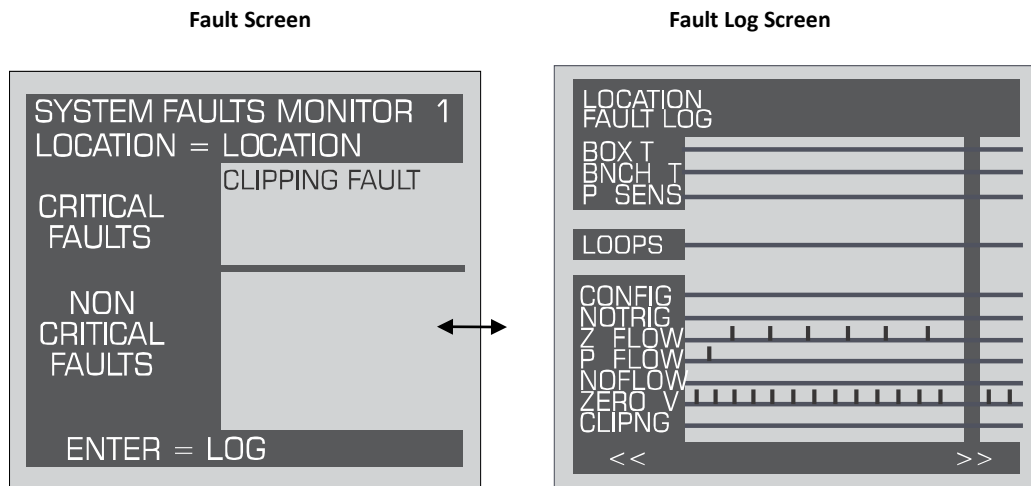

The Fault Log screen lists potential fault conditions in the left column. It also displays a check mark indicating which problems were associated with each fault condition, as represented by the vertical cursor bar. As you move the bar horizontally using the LEFT/RIGHT cursor keys, the date and time the fault condition was detected is displayed in the upper right hand corner of the display window.

Anytime the fault status changes, there is an entry in the fault log, both when the fault occurs and when it is cleared.

4.9. The Calibration Screen



NOTE: Calibration cannot be performed on the remote device. Information for performing this procedure on the main monitor is provided below.

4.9.1. Overview

The **Calibration Screen** is used to adjust the calibration factor for each refrigerant gas. It is also used to program the instrument for new gasses.



IMPORTANT: Changing information on CAL FACTORS will VOID the factory calibration. Typically, the unit will remain within the factory-calibrated accuracy indefinitely and no calibration is required. Complex software algorithms adjust for temperature drift, IR source aging, and pressure changes in order to keep the unit within factory accuracy specifications.

4.9.2. Navigating to the Calibration Screen

On the **System Screen**, select the target gas monitor and access that monitor's **Setup Screen #1**. Then select the CAL option to go to the selected monitor's **Calibration Screen**.

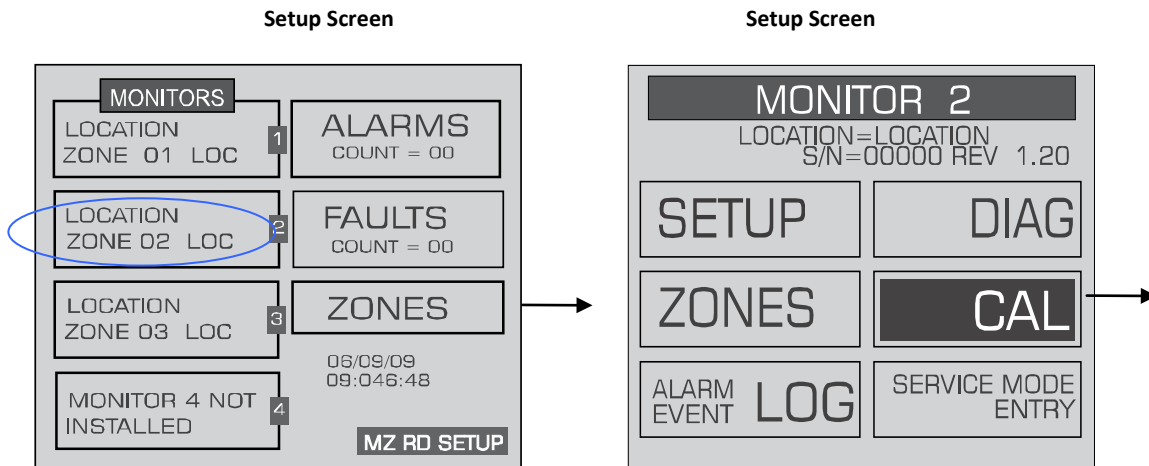

Calibration Screen

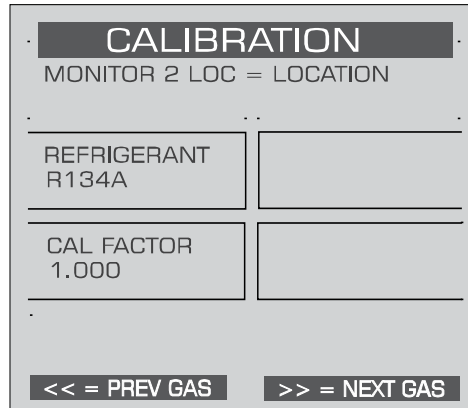

4.9.3. Adjusting Calibration Factor

The factory default cal factor for standard units is 1.000. This value may be different if the high accuracy option is ordered.

Modifications to calibration must be done on each monitor. If calibration is attempted from the MZ-RD unit, the “Use monitor front panel interface to adjust calibration” message is displayed.

4.10. The Diagnostic Screen

4.10.1. Overview

The **Diagnostic Screen** displays reference values for use by repair technicians for troubleshooting purposes.

4.10.2. Navigating to the Diagnostic Screen

On the **System Screen**, select the gas monitor you wish to view and press ENTER to access that monitor’s **Setup Screen**. Press the DIAG key to go to the selected monitor’s **Diagnostic Screen**.

System Screen

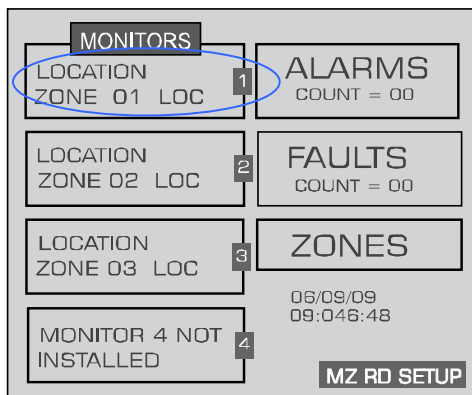

Setup Screen

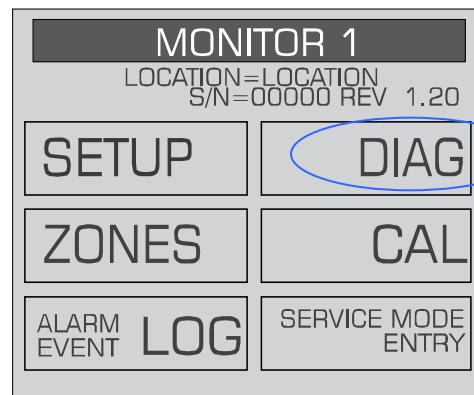

Diagnostic Screen

| DIAGNOSTIC DATA FOR MONITOR 1 | | | |
|-------------------------------|---|--|---------------|
| 01 ZONE 1 LOC | | | MODBUS |
| DET 4.2251V | F | | 485RX=8 |
| AVE 4.2273V | F | | 485TX=15 |
| ZERO 4.2267V | F | | FUNC=3 |
| NOISE 0.0009V | | | REG=0011H |
| AVEAU 0.00014 | | | |
| UM/L 0.000B | | | 0.000AMB |
| PPM 0.7B | | | 0.8STP |
| R134A NOW ZERO DELTA | | | |
| BENCH 27.78C | F | | 27.80C -0.02C |
| BOX 29.97C | F | | 29.96C 0.01C |
| PRES 13.63PSIA | | | -0.85 DP F |
| VAC 11.34PSIA | | | -3.20 DP |
| AMB 14.54PSIA | | | 2.29 DV F |
| FAULT CODE=0000 | | | 0100 FEET |

4.10.3. Diagnostic Screen Overview

The **Diagnostic Screen** contains sensor data and status information useful for trouble shooting various fault conditions. An explanation of each line of this screen is given below along with normal operating ranges.

| Field Name | Description |
|--------------|--|
| xxxx FEET | Programmed length of tubing for an active zone. |
| xx ZONE name | Current active zone and user-programmed name. This field may also show “WARM UP” during warm up mode. |
| DET | Detector Voltage – Peak-to-peak output of the IR sensor. In the absence of gas, this value range is 4.100V to 4.300V. |
| AVE | Average Detector Voltage – Running average of the values displayed in line 1. |
| ZERO | Zero Voltage – IR sensor output that was stored during the last purge cycle and has the same range as line 1. |
| NOISE | A 16 point running average of the noise portion of IR bench output. This reading is valuable mostly when gas is not present. |
| AVEAU | Average Absorbency – Optical absorbency computed from the Average Detector Voltage and Zero Voltage. In the absence of selected gas, the absorbency is 0.000AU. When sampling desired gas, its value varies proportionally with the gas concentration. |
| UM/L | uMoles/L – Absolute concentration in micro-moles per liter of gas based on Noise and the internal calibration. There are two figures displayed. The first (annotated by a B) is the actual measurement at the IR bench. The second is the calculated value corrected to ambient conditions (temperature + pressure). |

| Field Name | Description | | | | | | | | |
|-------------|---|-----------|------------------------------|------|----------|----------|-------------------------------|-----------|------------------|
| PPM | Parts Per Million is the volume concentration referenced to standard temperature and pressure and is computed from the Average Absorbency, Zero Temperature and Ambient Pressure. There are two figures displayed. The first (annotated by a B) is the actual PPM at the IR bench. The second is a PPM reading normalized to standard temperature and pressure. | | | | | | | | |
| ZERO | Zero Temperature – Displays the sensor and enclosure temperature measured and stored during the last purge cycle in degrees C. | | | | | | | | |
| BENCH | Bench Temperature – Current IR sensor temperature in degrees C as well as the raw voltage coming from the temperature sensor. This value can range from ambient to ambient +15 degrees C. | | | | | | | | |
| BOX | Box Temperature – This is the current internal enclosure temperature along with the raw voltage from the temperature sensor, and has the same range as the Bench temperature. | | | | | | | | |
| PRES | Pressure – This is the current absolute manifold pressure in PSIA along with the output voltage of the pressure sensor. This value should always be 0.2 to 1.0 PSIA below ambient (AMB). | | | | | | | | |
| VAC | Vacuum – The vacuum pressure is measured every purge cycle by closing all sample valves. Its value is typically 2.5 to 4.0 PSIA below ambient pressure. | | | | | | | | |
| AMB | Ambient – Ambient pressure is measured every purge cycle with the sample pump off and the manifold open. Its value is weather and altitude dependent and can range from 10.0 to 15.5 PSIA. | | | | | | | | |
| FAULT | Fault code listed in hexadecimal. See Fault Code list. | | | | | | | | |
| y.yyyX | Calibration multiplier used when measuring concentration. | | | | | | | | |
| TCx.xxxx | Temperature Compensation – magnitude of voltage applied to sensor output (in volts). Factory use only. | | | | | | | | |
| MODBUS data | <table border="0"> <tr> <td>485 RX=x</td> <td>Receive port number of bytes</td> <td>FUNC</td> <td>Function</td> </tr> <tr> <td>485 TX=x</td> <td>Transmit port number of bytes</td> <td>REG=xxxxx</td> <td>Register address</td> </tr> </table> | 485 RX=x | Receive port number of bytes | FUNC | Function | 485 TX=x | Transmit port number of bytes | REG=xxxxx | Register address |
| 485 RX=x | Receive port number of bytes | FUNC | Function | | | | | | |
| 485 TX=x | Transmit port number of bytes | REG=xxxxx | Register address | | | | | | |

4.11. Service Mode

When activated, the Service Mode will disable a specific gas monitor for a specified length of time, up to 240 minutes (4 hrs) to permit time for servicing the unit. The default is 60 minutes. This time interval can be changed as described in the *Service Timeout* section.

IMPORTANT: Note that while in the Service Mode, no measurements are made, nor are alarms activated.

1. From the **System Screen**, select the gas monitor you wish to place into Service Mode.
2. On **Monitor Setup Screen #1**, select SERVICE MODE ENTRY. An IN SERVICE option will appear to continue to “CONFIRM” or to “QUIT”.
3. To confirm IN SERVICE, press the ENTER key twice within 3 seconds.

Note that the **System Screen** will display which monitors are in the Service Mode.

To exit the Service Mode, select QUIT.

System Screen

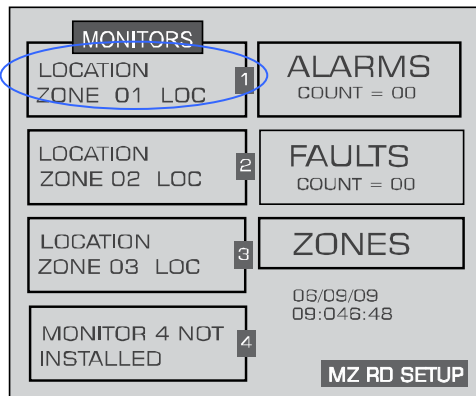

Monitor Setup Screen #1

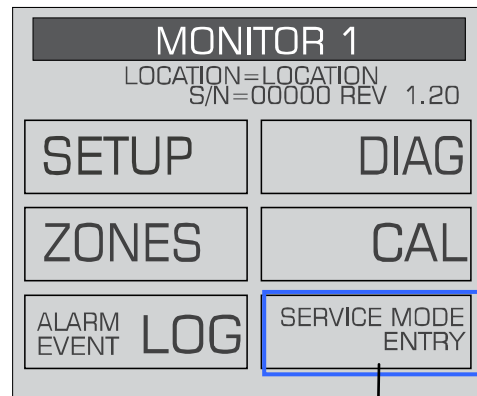

System Screen (Service Mode)

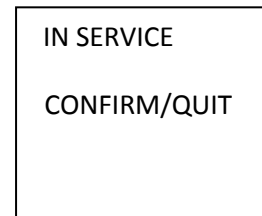
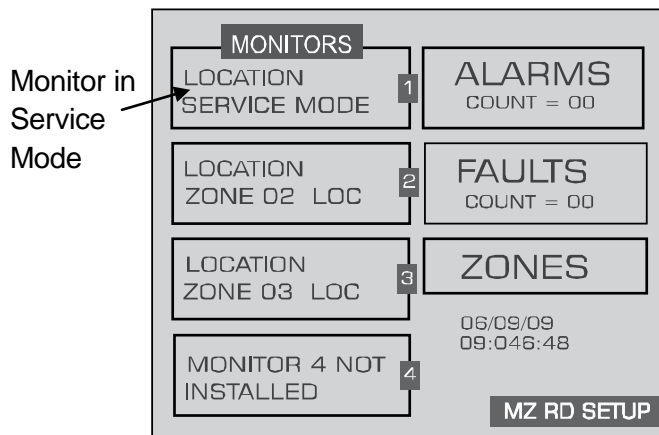

APPENDIX A. LOGIC DIAGRAM

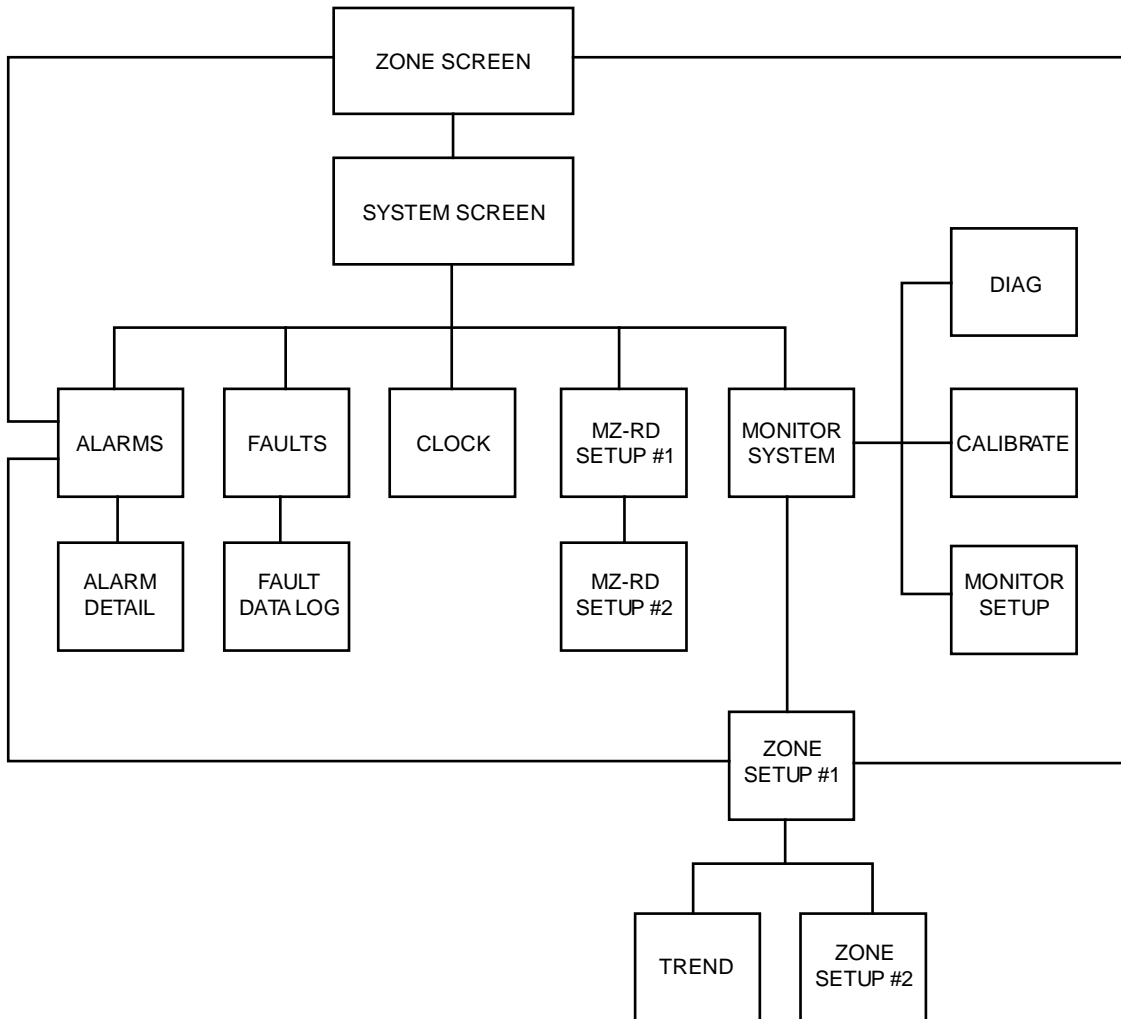

APPENDIX B. SPECIFICATIONS

| MZ-RD Specifications | |
|-----------------------------|---|
| Product Description | The Remote Display provides remote programming, interrogation and display functionality to support Bacharach’s gas monitors. The system design supports compliance to ANSI/BSR ASHRAE 15-2007 and ASHRAE Safety Code 34-2007. |
| Inputs | The MZ-RD accepts inputs from up to four gas monitors. It offers a wide variety of displays and can fully program any associated monitor. |
| Display | Back lit LCD. |
| Data Logging | The user may view a graphical display of the ppm trend for each zone. |
| Power Indication: | Green LED glows when AC power is applied |
| Alarm Indication: | Red LED glows and alarm condition is displayed |
| Fault Indication: | Yellow LED glows and fault condition is displayed |
| Password Protection | The MZ-RD can be password protected to prevent the unauthorized editing of setup parameters without disturbing the ability to monitor system outputs. |
| Power Safety Mode | Fully automatic system reset; all parameters maintained |
| Monitoring Distance | Up to 4500 feet (1372 m) from furthest gas monitor |
| Communications: | Full two-way communication with gas monitor monitors via RS-485 interface. Second RS-485 interface provided for connection to a Building Management System. |
| Relays: | Two SPDT programmable alarm contacts are provided rated 2A at 250VAC (inductive) and 5A at 250VAC (resistive) |
| Operating Temp | 32 to 113 °F (0 to 45 °C) |
| Ambient Humidity | 5 to 90% (non-condensing) |
| Size/Weight | 11" x 10" x 3" (27.9 cm x 25.4 cm x 7.6 cm) |

| MZ-RD Specifications | |
|--|--|
| (HxWxD) | |
| Weight | 5 lbs. (2.3 kg) |
| AC Power | 100 to 240 VAC, 50/60 Hz, 20 W |
| Mounting | Wall mount |
| Certification | UL 61010-1, CAN/CSA 22.2 No. 61010-1 & CE Mark |
| Warranty | 2 years from date of shipment |
| Altitude Limit | 6,562 ft (2,000 m) |
| <i>Specifications subject to change without notice</i> | |

APPENDIX C. AGENCY APPROVALS



CE Declaration of Conformity

The Manufacturer of the Products covered by this Declaration

BACHARACH Inc
621 Hunt Valley Circle
New Kensington, Pa 15068

Year in which conformity is declared: 2008

Products: Refrigerant Monitors

Model: HGM-SZ, AGM-SZ, CO2-SZ, HGM-MZ, AGM-MZ, CO2-MZ and MZ-RD

The undersigned hereby declares that the above referenced products are in conformity with the provisions of the following Directives and Standards.

Standards:

EN 61326-1:2006 – Electrical Equipment for measurement, control and Laboratory use – EMC Requirements – Part 1 General requirements

EN 61010-1:2001 – Safety Requirement for Control, Measurement & Laboratory Equipment

Directives:

In accordance with EMC Directive (2004/108/EC)

In accordance with Low Voltage Directive (2006 / 95 EC)

Signature: 

Name: Doug Keeporis

Title: VP of Product Development

Date: 23 August 2010

The technical documentation file required by this directive is maintained at the corporate headquarters of Bacharach Inc

MET LABORATORIES, INC. CERTIFICATION RECORD



The applicant named below has been authorized by MET Laboratories, Inc. to represent the product(s) listed in this record as "MET Certified" and to mark this/these product(s) according to the terms and conditions of the MET Mark Utilization Agreement, MET Listing Reports, and the applicable marking agreements. Only the product(s) bearing the MET Mark and under a follow-up service are considered to be included in the MET Certification program. This certification has been granted under a System 3 program as defined in ISO Guide 67.

FILE NUMBER: E113096

APPROVAL DATE: November 30, 2010

REVISED: -

| PRODUCT(S) | MODEL(S) | ELECTRICAL RATINGS |
|--|---|--|
| Refrigerant Monitors and Remote Display Monitors | HGMSZ, AGMSZ, CO2SZ, HGM-MZ, Emerson, RLM, CIR, AGM-MZ, CO2-MZ, MZ-RD | Models HGMSZ, AGMSZ, and CO2SZ: 100-240Vac, 15 Watts, 50/60Hz |
| | | Models HGM-MZ, Emerson, RLM, CIR, AGM-MZ, CO2-MZ: 100-240Vac, 20 Watts, 50/60Hz |
| | | Model MZ-RD: 100-240Vac, 20 Watts, 50/60 Hz |

| STANDARD NUMBER | STANDARD TITLE | EDITION |
|---------------------------------|---|---------|
| UL61010-1/CSA C22.2 No. 61010-1 | Standard for Safety for Electrical Equipment for Measurement, Control and Laboratory Use: Part 1: General Requirements | Second |

MET LABORATORIES, INC. requires that any and all changes proposed in the previously identified product(s), that affects the information contained in the above referenced listing report, must be submitted to MET for evaluation prior to implementation to assure continued MET Certification status.

The above identified product(s) has/have been submitted by the applicant:

APPLICANT:

Bacharach, Inc.
621 Hunt Valley Circle
New Kensington, PA 15068

The covered products shall be subjected to follow-up inspections to ensure that the Certified product(s) are identical to the representative product sample evaluated by MET LABORATORIES, INC. and that all manufacturer's responsibilities are being fulfilled as specified in the MANUFACTURING RESPONSIBILITY section of the Certification report.

Rick Cooper
Director of Laboratory Operations,
Safety Laboratory



*MET Laboratories, Inc. is accredited by OSHA and the Standards Council of Canada.
The Nation's First Nationally Recognized Testing Laboratory*



APPENDIX D. SERVICE CENTERS

Replacement parts and service can be obtained by contacting one of the following Bacharach Service Centers.

United States

Bacharach, Inc.
621 Hunt Valley Circle
New Kensington, PA 15068-7074
Phone: 724-334-5000, 800-736-4666
Fax: 724-334-5723
Email: help@MyBacharach.com

Canada

Bacharach of Canada, Inc.
20 Amber Street Unit #7
Markham, Ontario L3R 5P4 Canada
Phone: 905-470-8985
Fax: 905-470-8963
Email: bachcan@idirect.com

Europe

Murco Limited – a Bacharach Company
114a Georges Street Lower
Dun Laoghaire
Co. Dublin
Ireland
Phone: 353 1 284 6388
Fax: 353 1 284 6389
Email: sales@murco.ie



Headquarters:

621 Hunt Valley Circle, New Kensington, PA 15068-7074

Toll Free: 800-736-4666 • Tel: +1-724-334-5000 • FAX: +1-724-334-5001

Website: www.MyBacharach.com • E-mail: help@MyBacharach.com



Printed in U.S.A.

® Registered Trademark of Bacharach Inc.