



MultiZone Gas Monitors

- HGM-MZ (Halogen)
- AGM-MZ (Ammonia)
- CO2-MZ (Carbon Dioxide)

Installation • Operation • Maintenance

UL 61010-1
CAN/CSA 22.2 No. 61010.1
EN 14624



Instruction P/N: 3015-5074
Rev. 13
January 2015

WARRANTY

Bacharach, Inc. warrants to Buyer that at the time of delivery this Product will be free from defects in material and manufacture and will conform substantially to Bacharach Inc.'s applicable specifications. Bacharach's liability and Buyer's remedy under this warranty are limited to the repair or replacement, at Bacharach's option, of this Product or parts thereof returned to Seller at the factory of manufacture and shown to Bacharach Inc.'s reasonable satisfaction to have been defective; provided that written notice of the defect shall have been given by Buyer to Bacharach Inc. within two (2) years after the date of delivery of this Product by Bacharach, Inc.

Bacharach, Inc. warrants to Buyer that it will convey good title to this Product. Bacharach's liability and Buyer's remedy under this warranty of title are limited to the removal of any title defects or, at the election of Bacharach, to the replacement of this Product or parts thereof that are defective in title.

The warranty set forth in Paragraph 1 does not apply to parts that the Operating Instructions designate as having a limited shelf-life or as being expended in normal use (e.g., filters).

THE FOREGOING WARRANTIES ARE EXCLUSIVE AND ARE GIVEN AND ACCEPTED IN LIEU OF (I) ANY AND ALL OTHER WARRANTIES, EXPRESS OR IMPLIED, INCLUDING WITHOUT LIMITATION THE IMPLIED WARRANTIES OF MERCHANTABILITY AND FITNESS FOR A PARTICULAR PURPOSE: AND (II) ANY OBLIGATION, LIABILITY, RIGHT, CLAIM OR REMEDY IN CONTRACT OR TORT, WHETHER OR NOT ARISING FROM BACHARACH'S NEGLIGENCE, ACTUAL OR IMPLIED. The remedies of the Buyer shall be limited to those provided herein to the exclusion of any and all other remedies including, without limitation incidental or consequential damages. No agreement varying or extending the foregoing warranties, remedies or this limitation will be binding upon Bacharach, Inc. unless in writing, signed by a duly authorized officer of Bacharach.

**Register your warranty by visiting
www.MyBacharach.com**

Product improvements and enhancements are continuous; therefore the specifications and information contained in this document may change without notice.

Bacharach, Inc. shall not be liable for errors contained herein or for incidental or consequential damages in connection with the furnishing, performance, or use of this material.

Patent 6,590,690

Copyright © 2000–2015, Bacharach, Inc., All Rights Reserved

No part of this document may be photocopied, reproduced, or translated to another language without the prior written consent of Bacharach, Inc.

BACHARACH® is a registered trademark of Bacharach, Inc. All other trademarks, trade names, service marks and logos referenced herein belong to their respective owners.

Table of Contents

SECTION 1. INTRODUCTION.....	1
1.1. About This Manual	1
1.2. Warnings and Cautions	1
1.3. Safety Precautions	1
1.3.1. Hazardous Areas.....	1
1.3.2. Combustible and Flammable Gases	2
1.3.3. AC Power Supply	2
1.3.4. Protective Grounding.....	2
1.3.5. Explosive Atmosphere.....	2
1.3.6. Proper Exhaust Venting	2
1.3.7. Accessing the Interior of the Monitor.....	2
1.3.8. Misuse and Modifications to the Instrument.....	3
1.3.9. In Case of Malfunction.....	3
1.3.10. Fusing.....	3
1.3.11. Installation Category.....	3
1.3.12. Altitude Limit.....	3
1.3.13. Cleaning	3
1.4. Key External Hardware Components.....	4
1.5. Functional Overview.....	4
1.5.1. General Description.....	4
1.5.2. Communications Options	5
1.5.3. Understanding Monitoring Levels.....	5
1.5.4. Response to the Presence of Multiple Refrigerants (HGM Only)	5
1.5.5. Suggested Location of Sampling Points	5
1.5.6. Locating a Remote Display (Optional)	6
1.6. Specifications	7
SECTION 2. INSTALLATION.....	9
2.1. Installation Considerations	9
2.1.1. Warnings and Cautions	9
2.1.2. Inspection	9
2.1.3. Location of the Monitor.....	9
2.1.4. Mounting Instructions	9
2.2. Connecting Gas Sample Lines.....	10
2.2.1. Overview.....	10
2.2.2. Tubing Considerations	11
2.2.3. Connecting Purge Line.....	11
2.2.4. Connecting Exhaust Line	11
2.2.5. Connecting Sample Intake Lines	11
2.2.6. Installing an Optional Splitter Kit	12
2.2.7. Connecting the Water Trap	12
2.3. Interior Components.....	13
2.4. Electrical Wiring.....	13
2.5. Connecting Communications Devices	15
2.5.1. Remote Display Module (RD) Connection	15
2.5.2. Integrating with Building Management Systems	15
2.5.3. Larger Integrated Systems.....	15
2.5.4. Changing Terminator Switch Settings.....	16
2.5.5. Personal Computer	16
2.6. Terminating Multiple Monitors	17
2.7. Connecting to a Building Management System	17
2.8. PC Software	18
2.8.1. Operation.....	18

2.8.2.	Saving and Sending Programs	20
2.8.3.	Trend Data	20
2.8.4.	Converting the TREND Text File to a Microsoft Excel File	20
2.8.5.	Saving and Printing Screens and Logs	20
2.8.6.	USB Type Laptops	20
2.9.	Optional Current Loop Interfaces	21
2.9.1.	Optional 4–20 mA DC Outputs.....	21
2.9.2.	4-20 mA DC Connections.....	22
2.10.	Connecting External Alarms.....	23
2.10.1.	Overview.....	23
2.10.2.	Connection	23
SECTION 3. SETUP PROGRAMMING.....		25
3.1.	Initial Power Up	25
3.2.	Data Display Screen.....	25
3.3.	Navigating to the 1st Setup Screen.....	25
3.4.	Navigating to the 2nd Setup Screen	25
3.4.1.	Location	26
3.4.2.	Number of Zones Installed	26
3.4.3.	Alarm Acknowledge Mode.....	26
3.4.4.	Audible Alarm	26
3.4.5.	Zone Hold	27
3.4.6.	Detection Limit.....	27
3.4.8.	Loop Mode	27
3.4.7.	Loop2 Factor	27
3.4.9.	Re-Zero Mode	28
3.5.	Navigating to the 3rd Setup Screen	28
3.5.1.	Overview.....	28
3.5.2.	Baud Rate	28
3.5.3.	Node Address.....	28
3.5.4.	Password.....	28
3.6.	Additional Service Features	29
3.6.1.	Service Timeout	29
3.6.2.	DET Digipot	29
3.6.3.	Node Address.....	30
3.6.4.	Sensor Temperature Coefficient (For Factory Use Only)	30
3.6.5.	Password.....	30
3.6.6.	Acquiring Temperature Coefficient (For Factory Use Only)	30
3.6.7.	IR Digipot.....	30
3.7.	Establishing the CO ₂ Sensor Baseline	30
SECTION 4. GENERAL OPERATION		31
4.1.	Functional Overview.....	31
4.2.	The Zone Setup Screen	31
4.2.1.	Location	31
4.2.2.	Gas/Refrigerant Type	31
4.2.3.	Distance.....	32
4.2.4.	Zone Temperature.....	32
4.2.5.	Current Detection Reading.....	32
4.2.6.	Log Interval.....	32
4.3.	Navigating to the 2nd Zone Setup Screen	32
4.3.1.	Leak Level	33
4.3.2.	Spill Level	33
4.3.3.	Evacuation Level	33
4.3.4.	Re-Setting the Peak PPM Value	33
4.4.	Alarms	33

4.4.1.	Functional Overview	33
4.4.2.	Responding to Alarms	34
4.4.3.	Alarm Detail Screen	34
4.4.4.	Acknowledging Alarms	35
4.4.5.	Silencing an Alarm	35
4.4.6.	Clearing the Alarm Event Log	36
4.5.	System Faults	36
4.5.1.	Functional Overview	36
4.5.2.	Navigating to the Fault Screen	37
4.5.3.	Critical Faults	37
4.5.4.	Non Critical Faults	38
4.5.5.	Reset to Factory Default Settings	38
4.5.6.	Clearing System Faults	38
4.5.7.	Viewing Fault Log	39
4.5.8.	Viewing Flow Log	39
4.6.	The Trend Screen	40
4.6.1.	Navigating to the Trend Screen	40
4.7.	The Calibration Screen	40
4.7.1.	Overview	40
4.7.2.	Navigating to the Calibration Screen	41
4.7.3.	Calibration Procedure (HGM and AGM Only)	41
4.7.4.	Adjusting Calibration Factor (HGM and AGM Only)	41
4.7.4.	CO ₂ Atmospheric Concentration	42
4.7.6.	Programming New Gases (HGM Only)	42
4.8.	Zone Hold Mode	43
4.9.	The Diagnostic Screen	44
4.9.1.	Navigating to the Diagnostic Screen	44
4.9.2.	Diagnostic Screen Overview	45
SECTION 5. MAINTENANCE		47
5.1.	Replacement Parts Overview	47
5.2.	Replacement Parts and Optional Accessories	48
5.3.	Troubleshooting	50
APPENDIX A. RECOMMENDED REFRIGERANT GAS ALARM SETTINGS		53
APPENDIX B. RS-485 COMMUNICATIONS PROTOCOL		55
B.1.	Overview	55
B.2.	MODBUS RTU Protocol	55
B.3.	MZ MODBUS RTU Operation	55
B.3.1.	Overview	55
B.3.2.	Protocol Details	55
B.3.3.	MZ Monitor Polling	56
B.3.4.	Network Topologies	56
B.3.5.	Key Comm Protocol Parameters	56
B.3.6.	MODBUS Exception Responses	57
B.3.7.	MODBUS Gas Enumeration	57
B.4.	Standard Register Summary	58
B.4.1.	Dynamic Register Summary (2000 Series; R; Function Code 03)	58
B.4.2.	Dynamic Register Summary (2000 Series; R; Function Code 03)	59
B.5.	Block Mode Register Summary	62
B.5.1.	Summary of Registers	62
B.5.2.	System Data Register 0x0010 (16 Dec) (R/W, 54 Bytes)	62
B.5.3.	Status Register 0x001 (17 Dec) (R/W, 10 Bytes)	63
B.5.4.	Fault Code Table	64
B.5.5.	Zone Data Register 0x12xx (R/W, 78 Bytes)	64

B.5.6. Alarms and Alarm Acknowledge	65
B.5.7. Date Time Register 0x0015 (21 Dec) (R/W, 14 Bytes)	65
B.5.8. Sensor Data Register 0x0016h (22 Dec) (R, 82 Bytes)	66
B.5.9. Release Zone Hold Register 0x0017h (23 Dec) (W, 10 Bytes)	66
B.5.10. Hold Zone Register 0x0018h (23 Dec) (W, 10 Bytes).....	66
B.5.11. MZ Hold Mode.....	66
B.5.12. Fault Log Register 0x1900-01 (6400-6401 Dec) (R, 302 Bytes).....	67
B.5.13. Flow Log Register 0x001F (31 Dec) (R, 142 Bytes)	67
B.5.14. Alarm Log Register 0x1A00-02 (6656-58 Dec) (R, 582 Bytes).....	67
B.5.15. Service Mode Register 0x001B (27 Dec) (W, 10 Bytes).....	67
B.5.16. Release Service Mode 0x001C (28 Dec) (W, 10 Bytes).....	67
B.5.17. MZ Service Mode	68
B.5.18. PPM Register 0x001E (30 Dec) (R, 32 Bytes).....	68
B.5.19. Zone Log Registers 0x3xyy (R, 1502 Bytes).....	68
APPENDIX C. SYSTEM MENU MAP.....	69
APPENDIX D. AGENCY APPROVALS	73
APPENDIX E. SERVICE CENTERS	75
INDEX	77

SECTION 1. INTRODUCTION

1.1. About This Manual

Thank you for investing in a Bacharach Multi-Zone Gas Monitor. To assure operator safety and the proper use of the monitor please read this manual. It provides important information on the installation, operation, maintenance, and servicing of the monitor and display module.

If you have a working knowledge of your gas monitor, you will find this manual useful as a reference tool. If you are new to the use of gas monitors, this document is educational in the principles of gas detection and the proper operation of this device.

1.2. Warning and Caution Conventions

When used in this manual or as **labeled on the gas monitor**, the following hazard symbols and/or associated words are defined as follows.



WARNING: This symbol and/or the use of the word **WARNING** indicates a potential hazard associated with the use of this equipment. It calls attention to a procedure, practice, condition, or the like, which if not correctly performed or adhered to, could result in death or serious injury.

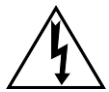

WARNING: This symbol and/or the use of the word **WARNING** indicates a potential hazard from **electrical shock**. It calls attention to a procedure, practice, condition, or the like, which if not correctly performed or adhered to, could result in death or serious injury.



CAUTION: This symbol and/or the use of the word **CAUTION** indicates a potential hazard associated with the use of this equipment. It calls attention to a procedure, practice, condition, or the like, which if not correctly performed or adhered to, could result in minor or moderate injury.



IMPORTANT: The use of the word **IMPORTANT** in this manual calls attention to a procedure, practice, condition, or the like, which if not correctly performed or adhered to, could result in incorrect performance of or damage to the equipment and may void the warranty.

1.3. Safety Precautions



WARNING: This instrument has not been designed to be intrinsically safe for use in areas classified as hazardous locations. For your safety, **DO NOT** use it in hazardous (classified) locations.



WARNING: This is NOT a safety device. Some gases which this instrument can detect may be combustible/flammable. When properly configured, this instrument is designed to alarm at concentrations that are lower than the explosive limit of the gas. As such, it is the buyer's responsibility to initiate an immediate planned response to any gas leaks as soon as they are detected. This equipment should NEVER be used to measure or sample gases at or above their respective lower explosive limits.



IMPORTANT: The gas monitor uses a universal power supply that is capable of accepting inputs of 100 to 240 VAC, 50/60 Hz. The monitor's power consumption is 20 Watts. It is highly recommended that the monitor be connected directly to the AC power source, preferably on its own circuit with UPS or surge protection.



WARNING: A switch or circuit breaker must be included in the building installation. The switch must be in close proximity to the monitor and within easy reach of the operator. The switch must be clearly marked as the disconnecting device for the equipment.



WARNING: Under no circumstances should the monitor be operated without connection to a protective ground. Doing so poses a potential shock hazard and is also a violation of electrical safety standards applicable to this type of equipment.



WARNING: Do not operate this equipment in the presence of flammable liquids, vapors, or aerosols. Operation of any electrical instrument in such an environment constitutes a safety hazard.



WARNING: It is imperative that the exhaust port on this instrument be properly vented as described in this manual. Failure to do so may constitute a safety hazard.



WARNING: Extreme care should be exercised when accessing the interior of the monitor. Only qualified electrical maintenance personnel should make connections and perform adjustments. Always remove AC power before opening the monitor's enclosure.



WARNING: The protection provided by the monitor may be impaired if the monitor is used in a manner not specified by Bacharach, Inc. Modifications to this monitor, not expressly approved, will void the warranty.



WARNING: Do not continue to use this equipment if there are any symptoms of malfunction or failure. In the case of such occurrence, de-energize the power supply and contact a qualified repair technician or the nearest Bacharach Service Center.



WARNING: This device uses type "F" fuses (F1 and F2) rated at 1.0 A, 250 VAC. Replace ONLY with Bacharach-approved fuses.



WARNING: Electrical installation should be performed by a certified electrician, and must comply with all applicable NEC/CEC and local electrical safety codes.



IMPORTANT: Use ONLY the provided knockouts for electrical and communications wiring. Drilling into the box will void the warranty.



IMPORTANT: This device is classified as Installation Category II, Pollution Degree II, as defined by UL.



IMPORTANT: This device is designed for operation at or below an altitude of 6,562 ft (2,000 m). Do not operate this device above this altitude limit.



NOTE: To clean the outside of the case use a dry cloth. To avoid shock hazard and/or equipment damage, DO NOT use soap and water.

1.4. Key External Hardware Components



Figure 1-1. Multi-Zone Monitor Front View



NOTE: Mounting cutouts are located on the back of the monitor, and are visible from inside the Multi-Zone monitor. A mounting template is also shipped with the monitor. For mounting information, refer to the mounting instructions on page 8.

Standard Accessories for a 4-Point System

QTY	Description	Part Number
5	Line-End Filters	3015-3420
1	Charcoal Filter (Halogen Gas Monitor Only)	3015-3125
3	End-of-line Water-Stop Filter Assembly	3015-5512
1	T-Bolt Bracket (Halogen Gas Monitor Only)	3015-2969
1	Multi-Zone Instruction Manual	3015-5074

1.5. Functional Overview

1.5.1. General Description

Gas monitors are specified to support compliance to federal, state and local safety codes governing emissions. Avoiding significant loss reduces equipment replacement costs, maintains equipment efficiency, promotes safety, and protects the environment.

The Bacharach Multi-Zone Monitor provides continuous monitoring of gas levels in up to 16 separate test zones. The instrument is easily programmed to monitor a variety of gases (dependent on particular model) and independent leak (small), spill (medium), and evacuation (large) levels may be designated for each zone. The instrument also retains a log of previous readings that can be easily accessed for analysis.

An audible alarm and front panel indicators are provided to signal alarm and fault conditions, and relay contacts are provided that can be used to trigger external alarm devices in the event of a system fault, or if a leak (small), spill (medium), or evacuation (large) level of gas is detected. The system also may be fitted with an optional two-channel 4-20 mA current loop board for connection to remote monitoring equipment.

The multi-zone monitor requires only minor periodic maintenance such as the occasional replacement of filters. The monitor incorporates active diagnostics that continuously check the system for proper operation. A front panel indicator is provided to alert an operator of system malfunctions, and fault codes are generated that enable the user to identify the cause of the fault.

1.5.2. Communications Options

The multi-zone monitor features full two-way communications via an RS-485 interface. MODBUS RTU is the communications protocol standard. The instrument can be connected directly to a Building Management System or it may be operated as a stand-alone system.

An RS-232C port is also provided for connection to a PC. This enables the monitor to be setup from a personal computer. Refer to Appendix B for more information on communications protocols.

1.5.3. Understanding Monitoring Levels

Effective use of this instrument requires an understanding of what constitutes reasonable alarm set points for the types of gas being monitored. Manufacturers define allowable exposure levels and threshold limit values in units of parts per million (ppm). In a good “tight” installation these background levels will be acceptably low and often do not require corrective action. You can reduce nuisance alarms and needless service calls if the alarm levels are set at practical limits. Bacharach has developed recommended monitoring refrigerant gas levels based on compliance to ANSI/BSR ASHRAE 15-2007 and ASHRAE Safety Code 34-2007. These reference levels are listed in Appendix A.

Setting the monitor at these recommended alarm levels will satisfy the needs of most users. However, the ppm levels generated by system leaks into the environment are greatly influenced by the volume of air in the sampling area, air circulation, size of the leak, distance to the monitoring point, and a host of other variables. In some cases the set points may need to be adjusted either up or down to achieve effective monitoring.

1.5.4. Response to the Presence of Multiple Refrigerants (HGM Only)

The HGM-MZ is a refrigerant level monitor, not a gas analyzer. You must program the monitor to test for a specific refrigerant, and it will only return accurate concentration readings for that particular refrigerant. If a leak occurs of another refrigerant gas type, the monitor may return incorrect readings.

Most applications only require detection of a single refrigerant and the problems that are associated with monitoring multiple gases are rarely an issue. If there is a possibility of multiple refrigerants leaking in the same sampling zone, then you should carefully consider which refrigerant compound you program the unit to monitor.

1.5.5. Suggested Location of Sampling Points

At the point of a leak the gas is nearly pure. As the gas is dispersed into the air, the gas molecules diffuse, causing a dilution of the original concentration. The monitor measures the concentration at the sample collection point. Therefore, if the termination of the collection line is not at the exact point of the leak, the unit will read a diluted mixture of the gas and air.

Gases of interest may be heavier or lighter than air and may collect above or below the point of the leak. Therefore sampling point placement is critical and must take into account properties of the target gas and air flow within the space. In general, sampling points should be located as close as possible to the sources of potential leaks. If this is impractical, then alarm set points for that zone should be adjusted to compensate for the dilution of the gas. General placement guidelines are shown below, but air-flow dynamics should also be considered (e.g., consider the effects of exhaust fans which tend to draw target gas from the space).

- HGM-MZ Halogen Mount sampling points 6-18 inches above floor
- AGM-MZ NH₃ (Ammonia) Mount sampling points 1-2 feet below ceiling
- CO₂-MZ CO₂ (Carbon Dioxide) Mount sampling points 4-6 feet above floor (breathing zone)

DO NOT block any of the zones. Unused zones may be disabled by setting the distance parameter to zero feet in the zone setup screen.

The MZ monitor should be centrally located in the mechanical room and be readily accessible for easy visual monitoring and servicing. The combined length of sample tubing plus exhaust tubing should not exceed 1200 ft (366 m) for any zone. The fresh air purge line should draw from an area that does not contain any gas other than fresh air. The exhaust line should run to an outside location if possible.



NOTE: The combined length of the purge line and the exhaust line cannot exceed 500 feet.

Ideally, two to three pick up points spaced around each chiller will provide sufficient coverage. It may be necessary to perform a smoke test of the mechanical room to determine the best locations. The smoke test provides the pattern of air currents present in the mechanical room.

The MZ monitor should be kept dry. When used in a wet or humid area, it is highly recommended to use the optional water stop accessory to avoid internal damage.

1.5.6. Locating a Remote Display (Optional)

The Remote Display (RD) Module should be mounted outside of the mechanical room, or just inside the room's doorway if the first option isn't possible. This is the "split architecture design" for safety of the operator. The RD can be located up to 4500 feet (1372 m) from the MZ monitor. The RD is the man machine interface by which you program the MZ, acknowledge alarms and observe conditions inside of the mechanical room. Note that there are two additional alarm relay contacts in the RD that can be programmed to alarm on leak, spill, evacuate, fault, or monitor on conditions.

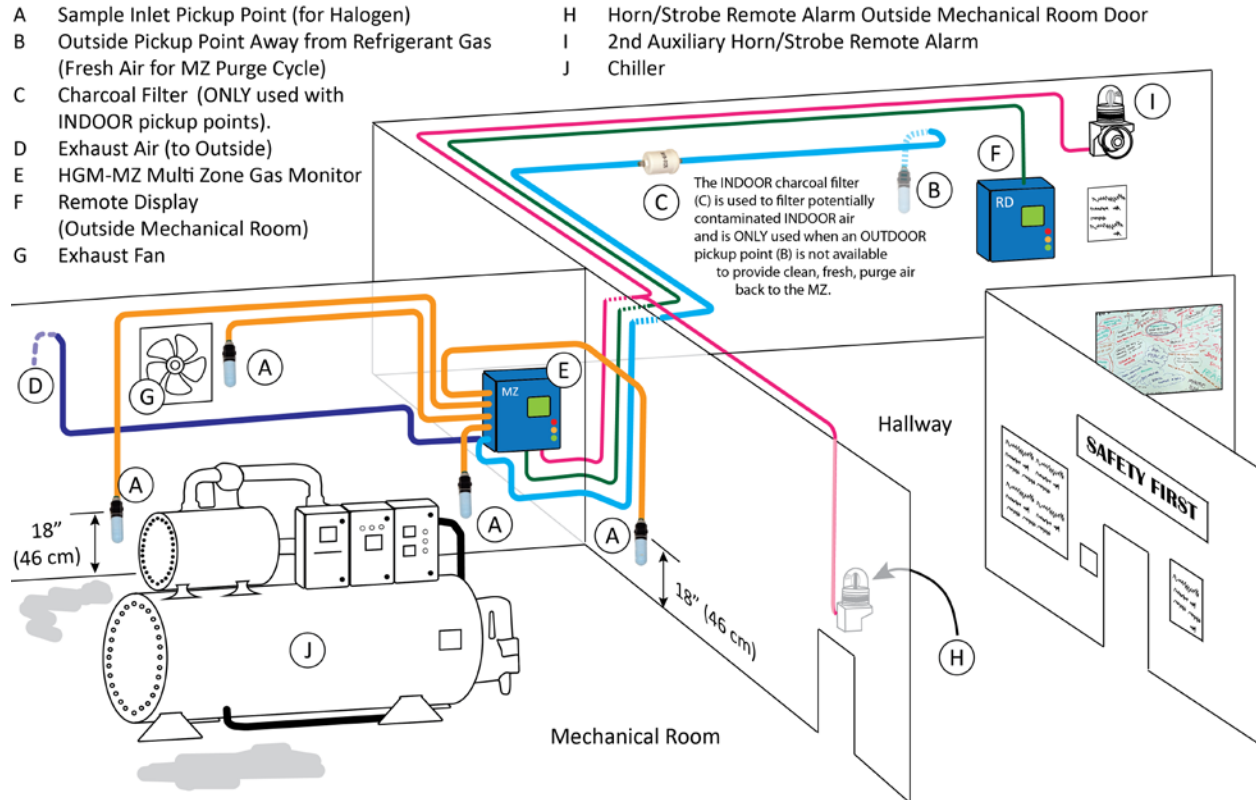

Figure 1-2. HGM-MZ (Halogen) and RD Placement in a Mechanical Room



NOTE: The pickup points located on the floor in the above illustration are examples for refrigerants which are heavier than air. Placement of pickup points should be determined based on characteristics of the gas being monitored and ambient conditions of the sampling area. (Air=28.9 g/mole, CO₂=44.0 g/mole, NH₃=17.0 g/mole, and halogens = 100+ g/mole.)

1.6. Specifications

HGM-MZ Specifications	
Product Type	Multiple refrigerant gases and multiple area monitoring system for low level continuous monitoring of CFC, HCFC and HFC refrigerant gases used in most commercial refrigeration systems. System design supports compliance to the refrigerant monitoring requirements of ANSI/BSR ASHRAE 15-2007 and ASHRAE Safety Code 34-2007.
Sensitivity	All gases 1 ppm
Measuring Range	All gases 0 to 10,000 ppm
Accuracy¹	Most gasses: ±1 ppm ±10% of reading from 0-1000 ppm (R11, R22, and R113 ±10 ppm ±15% of reading 0-1000 ppm)
Gas Library	<p>CFC: HFP, R-11, R-12, R-113, R-114, R-502</p> <p>HFC: R125, R-134a, R236FA, R245Fa, R32, R-404a (HP62), R-407a, R-407c (AC9000), R-407F, R-410a (AZ20), R422a, R422d, R427a, R-507 (AZ50), R-508b (SUVA95)</p> <p>HCFC: R-123, R-124, R21, R-22, R227, R-23, R-401a (MP39), R-402a (HP80), R-402b (HP81), R-408a, R-409a, R-500, R-503</p> <p>Halon: H1211, H1301, H2402</p> <p>Other: FA188, FC72, H1234YF, H1234ZE, N1230, N7100, N7200, N7300, N7600, R424A, R426A, R438A, CUSTOM</p>

AGM-MZ Specifications	
Product Type	The AGM-MZ provides multiple area monitoring system for low level continuous monitoring of Ammonia gases used in most commercial systems.
Sensitivity	20 ppm
Measuring Range	25 to 10,000 ppm
Accuracy¹	Most gasses: ±10 ppm ±10% of reading from 0-10,000 ppm
Gas Library	Ammonia (NH ₃)/R-717

CO ₂ -MZ Specifications	
Product Type	The CO ₂ -MZ provides multiple area monitoring for low level continuous monitoring of carbon dioxide gases used in most commercial systems. System design supports compliance to the gas monitoring requirements of ANS/BSR ASHRE 15-1994.
Sensitivity	10 ppm
Measuring Range	300-8,000 ppm
Accuracy¹	Most gasses: ±5 PPM ±5% of reading from 300-1000 ppm, ±10% of reading from 1001-3000 ppm
Gas Library	Carbon Dioxide (CO ₂)/R-744

¹ At reference environmental conditions (25°C, 45% RH non-condensing, 1 ATM)

General Multi-Zone Specifications	
Coverage	4 point standard, expandable to 16 points in 4 point increments
Detector Type	Infrared Non-Dispersive
Front Panel	3 Indicator lights: <ul style="list-style-type: none"> • Green Monitor is powered on. LED glows during normal operation; flashes when unit is in warm-up mode • Red Alarm. LED flashes when any point has exceeded the alarm setting. • Yellow Fault. LED flashes when there is a system fault
Size (H x W x D)	12.23" x 13.7" x 4.96" (31.06 cm x 34.80 cm x 12.60 cm)
Weight	15 lbs. (6.8 kg)
Sampling Mode	Automatic or manual (hold)
Re-Zero	Auto or on zone change
Response Time	5 to 315 seconds – depending on air line length and number of zones
System Noise	Less than 40 dB(A) @ 10 feet (3m)
Monitoring Distance	1,200 ft (366 m) maximum for combined length of sample + exhaust tubing (each zone)
Conditioned Signal	Dual optional 4-20 mA DC isolated outputs. Channel 1 = zone area, Channel 2 = PPM
Alarms	Four SPDT alarm contacts rated 2A at 250 VAC (inductive) 5 A at 250 VAC (resistive). Three are assigned to PPM level alarms, one assigned to system faults.
Communications	Full two-way communications with Remote Display Module or Building Management System via RS-485 serial interface. RS-232C communications port standard.
Power Safety Mode	Fully automatic system reset. All programmed parameters retained.
Operating Temp	32 to 122 °F (0 to 50 °C)
Ambient Humidity	5% to 90% RH (non-condensing)
AC Power	100 to 240 VAC, 50/60 Hz, 20 W
Certification	UL 61010-1, CAN/CSA 22.2 No. 61010-1 & CE Mark
Warranty	2 years from date of shipment
Altitude Limit	6,562 ft (2,000 m)
Sensor Life	7-10 years

SECTION 2. INSTALLATION

2.1. Installation Considerations

2.1.1. Warnings and Cautions



WARNING: Explosion hazard! Do not mount the MZ monitor in an area that may contain flammable liquids, vapors, or aerosols. Operation of any electrical equipment in such an environment constitutes a safety hazard.

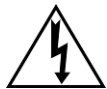

WARNING: Shock hazard! Always disconnect AC power before working inside the monitor.



CAUTION: Drilling holes in the MZ enclosure may damage the unit and will void the warranty. Please use the knockouts provided for electrical connections.



CAUTION: The MZ monitor contains sensitive electronic components that can be easily damaged. Do not touch nor disturb any of these components.

2.1.2. Inspection

The MZ monitor has been thoroughly inspected and tested prior to shipment from the factory. Nevertheless, it is recommended that the monitor be re-checked prior to installation. Inspect the outside of the enclosure to make sure there are no obvious signs of shipping damage. Open the enclosure and inspect the interior of the monitor for loose components that may have become dislodged during shipment. If damage is discovered, please contact the nearest Bacharach Service Center for assistance.

2.1.3. Location of the Monitor

The MZ monitor should be centrally located in the facility and should be easily accessible for visual monitoring and servicing. Combined length of the intake sample line and the exhaust line cannot exceed 1200 feet (366 m) in length, but it is important to remember that sampling cycle time is proportional to the total number and length of individual sample lines.

Dirt, grease, and oils can adversely affect the operation of the MZ monitor. The monitor should be installed out of direct sunlight in a clean, dry area that is not subject to temperature or humidity extremes. Installation of the monitor in a mechanical room is acceptable provided reasonable environmental conditions exist. If there is a question, consider installing the unit outside of the mechanical room in a cleaner area of the facility.



NOTE: The mounting location of the monitor should allow it to be easily accessible for visual monitoring and servicing.

2.1.4. Mounting Instructions



NOTE: The MZ monitor should be installed plumb and level and securely fastened to a rigid mounting surface.

The enclosure utilizes keyhole mounting brackets designed for ¼ inch fasteners. Locate the four screws as shown in the diagram below or by using the provided mounting template (P/N 3015-5109). Allow the screw heads to protrude approximately ¼ inch.

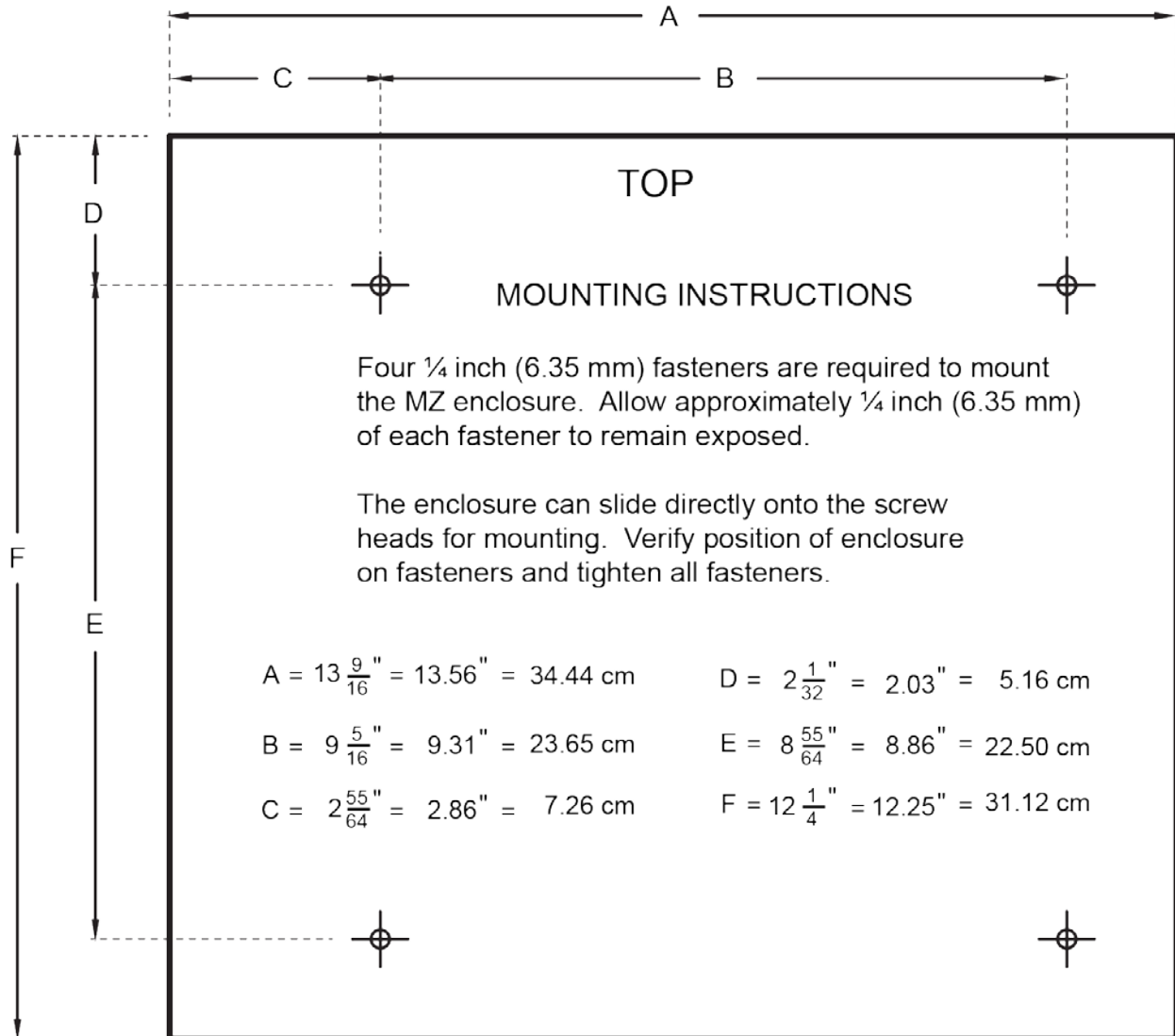

Figure 2-1. MZ Monitor Mounting Specifications

Hold the monitor flat against the mounting surface and allow it to slide down, engaging the screw heads in the keyhole slots of the mounting brackets. Adjust the screws as necessary to hold the monitor securely against the mounting surface.

2.2. Connecting Gas Sample Lines

2.2.1. Overview

Individual gas sample lines are run from the MZ monitor to each area of the facility to be monitored. Additionally, a purge line is installed to provide clean air for resetting the infrared zero baseline. All air, sample, and purge line connections are located on the left side of the enclosure. Refer to the illustration below.

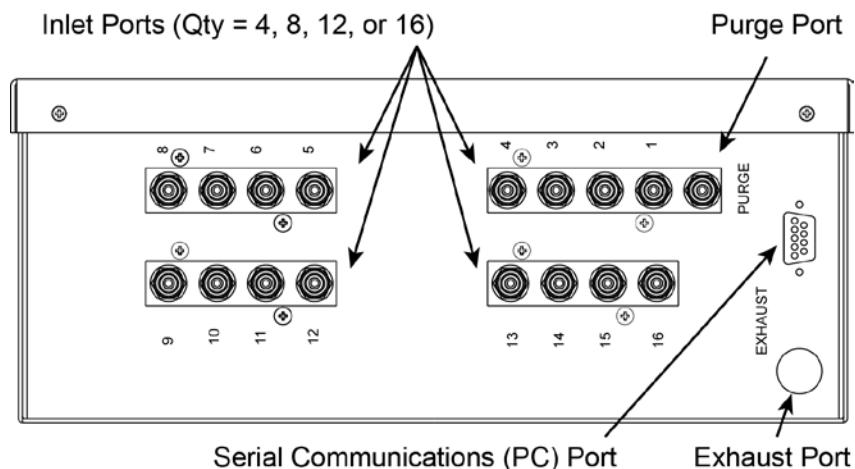

Figure 2-2. MZ Monitor Side View

2.2.2. Tubing Considerations

Use ¼" (6.35 mm) outside diameter (0.040" or 1.016 mm wall) flex tubing for all air lines (P/N 3015-3235) or equivalent. The tubing should be clean and free of residual moisture or other contaminants. The tubing should be cut cleanly with a sharp knife and care should be taken not to distort the tubing end.

To connect the air lines to the monitor simply push the tubing firmly onto the connector. To remove a line, press the plastic ring on the connector with one hand, then withdraw the tube with your other hand. See below.

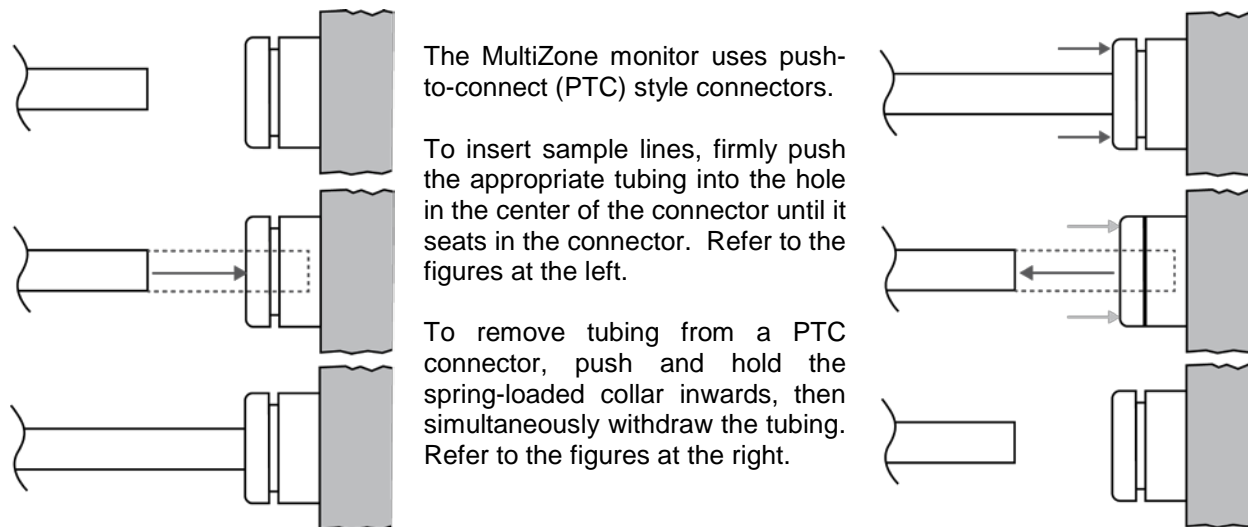

Figure 2-3. Using PTC Connectors: Connecting (Left) and Disconnecting (Right)

All tubing bends should have a radius of no less than 5" (12.7 cm) to ensure proper airflow. If kinks or obstructions occur in any of the air lines the instrument may not function properly.

2.2.3. Connecting Purge Line

A purge line is an intake line that is required to draw fresh air *into* the instrument and should not exceed 300 feet (91.44 m) in length. It is advisable to terminate the purge line outdoors, provided the input is not exposed to rain, snow, ice, exhaust fumes, or other airborne contaminants. If an outdoor installation is impractical, the line should be run to an area inside the facility that you are certain is not contaminated with ambient gas. If this is not possible, an optional charcoal filter assembly (P/N 3015-3125) can be used

with the Halogen Gas Monitor to filter refrigerant from the purge line. It may be mounted adjacent to the monitor. A line-end filter (P/N 3015-3420) should be attached to the end of the purge line when the charcoal filter is not used. Note that the charcoal filter option must NOT be used in ammonia or CO₂ applications.



IMPORTANT (CO₂ Only): Because CO₂ is present in ambient air, the purge line MUST BE run outside, away from any known sources of CO₂ gas. An atmospheric CO₂ concentration value can be manually entered by the user in the CAL screen. See CO₂ Atmospheric Concentration (page 42).

2.2.4. Connecting Exhaust Line

An exhaust line can be used when it is required to vent gas samples away from the instrument and should not exceed 300 feet (91.44 m) in length. The exhaust line should terminate in a location that is completely isolated from the purge line termination point and other areas of the facility that will be monitored. Ideally this line should terminate outdoors in a location that is not exposed to the elements. This line does not require a line-end filter. If the exhaust line terminates outside the building, position the tubing so that no water or moisture can enter it.

2.2.5. Connecting Sample Intake Lines

The MZ monitor is designed to accommodate up to 16 separate sample intake lines. The standard configuration of the unit includes one manifold of 4 intake connectors and 1 purge connector. Additional manifolds can be easily installed to increase monitoring capacity (field installation kit P/N 3015-5171, and 4 zone line end filter kit P/N 3015-3411).

Sample intake lines can be up to 1,200 feet (366 m) when no exhaust tubing is used. Otherwise, the combined length of the sample line and the exhaust line cannot exceed 1,200 ft (366 m). All line terminations should be positioned to reduce the possibility of mists, aerosols, oil, water, dust, or other contaminants being drawn into the instrument. A line-end filter (P/N 3015-3420) should be attached to the end of each sample intake line. General placement guidelines are shown below, but air-flow dynamics should also be considered (e.g., consider the effects of exhaust fans which tend to draw target gas from the space).

- HGM-MZ Halogen Mount sampling points 6-18 inches above floor
- AGM-MZ NH₃ (Ammonia) Mount sampling points 1-2 feet below ceiling
- CO₂-MZ CO₂ (Carbon Dioxide) Mount sampling points 4-6 feet above floor (breathing zone)



IMPORTANT: DO NOT block any of the zones. Unused zones may be disabled by setting their length parameter to zero in the zone setup screen.

Depending on type of use and location of lines, the end-of-line water stop filter assembly can be used to prohibit moisture from entering the intake lines. Three (3) end-of-line water stop filters are supplied with a standard unit. Place the end of the intake line into the blue receiver of the end of line water stop and tighten sufficiently.



NOTE: Only one filter assembly, either the line-end filter or end-of-line water stop, should be used for each line.

Please refer to the earlier section *Suggested Location of Sampling Points* (page 4) to learn more about where to place the ends of the sample intake lines.

2.2.6. Installing an Optional Splitter Kit

Splitter kits are made available which allow the MZ unit to take gas sample readings from several sample points while utilizing just a single zone. These kits are designed for use ONLY in confined/defined spaces with high potential for leaks, such as food cases, cold rooms, refrigeration rack rooms, etc. Bacharach's 2-way (P/N 3015-5404) and 3-way (P/N 3015-5405) splitter kits are available as optional accessories. Refer to instruction 3015-5415 (supplied with the kit) for detailed installation instruction.

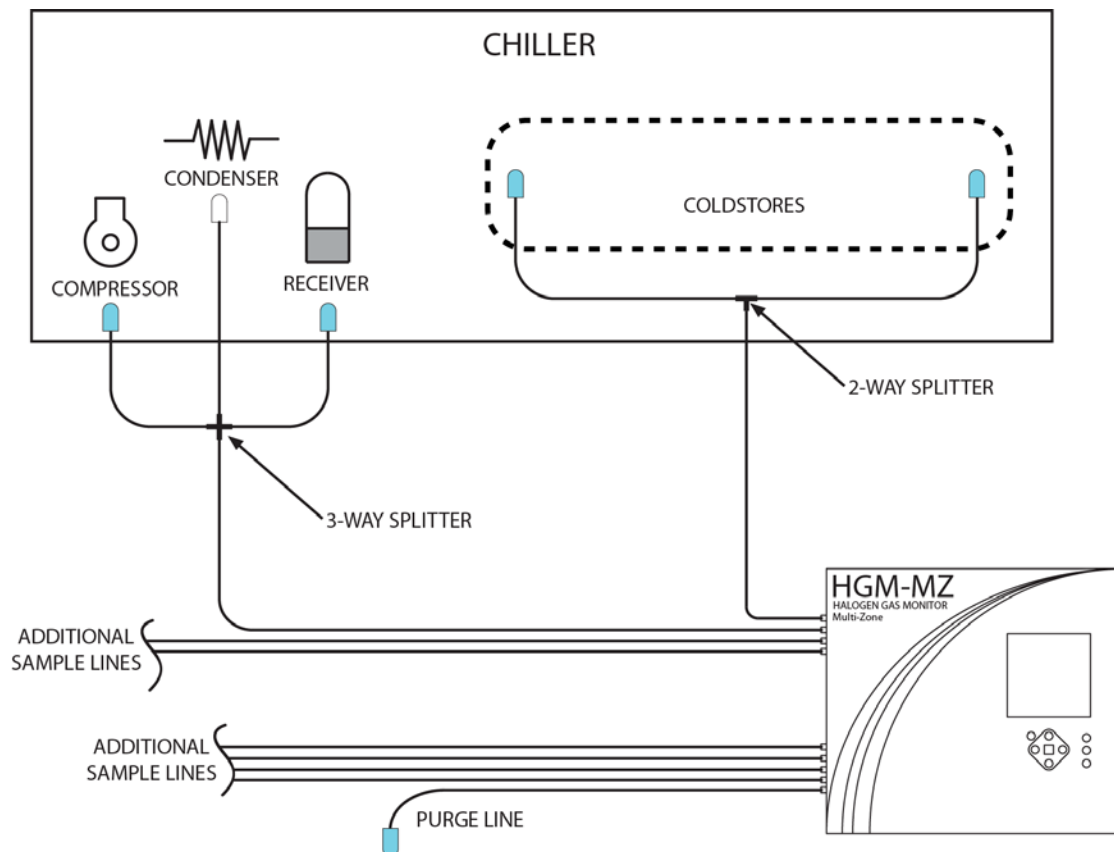

2.2.7. Connecting the Water Trap

The water trap is an optional accessory for applications that result in water or condensation frequently entering the intake lines. This is available in a manual style trap (P/N 0007-1655) which is manually emptied once it has become filled. Install the water trap close to the unit for the most effective results. The intake line may be cut where the user finds appropriate (preferably close to monitor). Each side of the intake line should be inserted into the receivers on either side of the water trap. Secure tightly. A replacement filter (P/N 0007-1656) for the water trap is available and is replaced by unscrewing the clear plastic cup of the water trap, pulling the filter directly out (do not unscrew), and inserting the new filter into place. Replace the cup of the water trap. If desired, an optional mounting bracket (0007-1657) may be used to secure the water trap in place.



NOTE: The termination filter (P/N 3015-3420) or end-of-line water stop filter (P/N 3015-5512) should be used, regardless of the presence of a water trap.



IMPORTANT: Extreme or humid temperatures may cause water to condense in the tubes. A water trap is highly recommended for use in these scenarios.

2.3. Interior Components

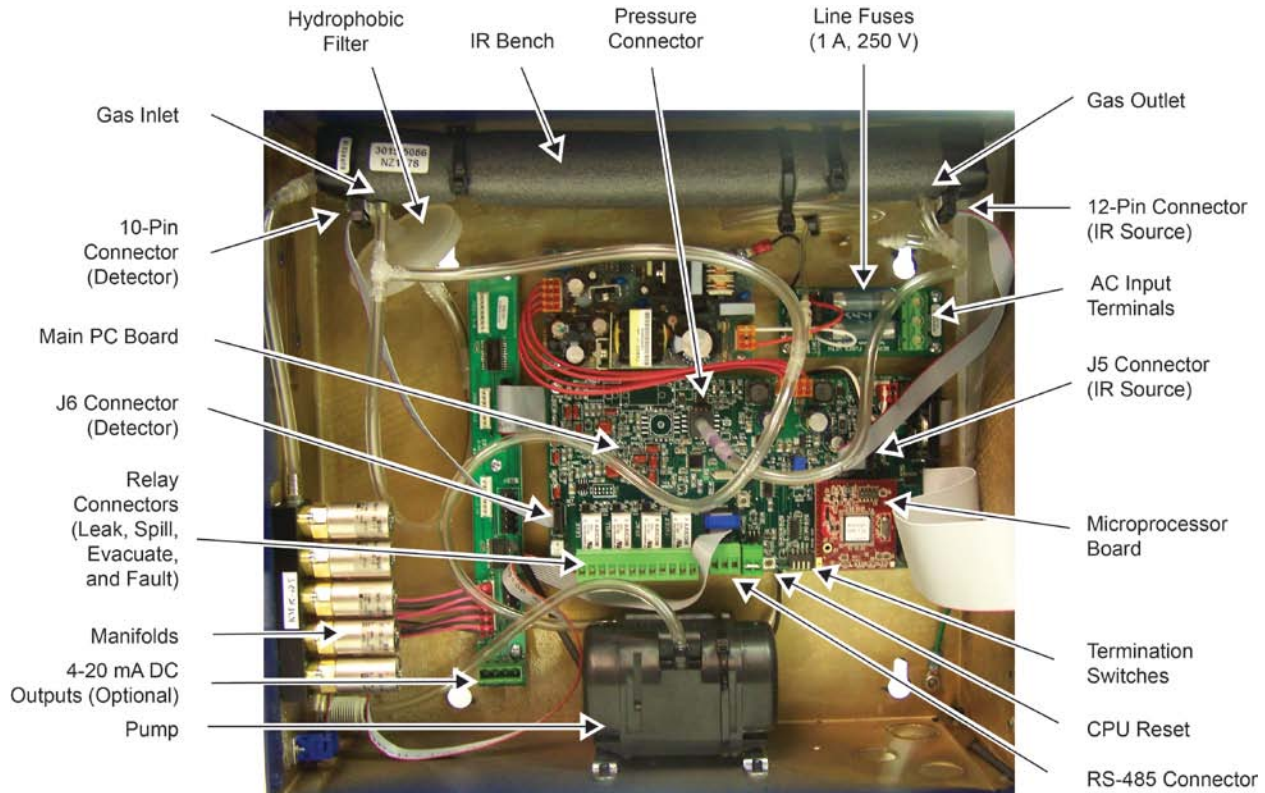

Figure 2-4. MZ Monitor Interior Components



NOTE: The plastic cable ties surrounding the air pump are to ensure safe handling during shipping. Please remove before operation. Reinstall a plastic cable around the air pump if the unit is shipped to Bacharach, Inc. for service or repair. This prevents damage during shipping.

2.4. Electrical Wiring

The MZ monitor uses a universal power supply that is capable of accepting inputs of 100 to 240 VAC, 50/60 Hz. The monitor's power consumption is 20 Watts. It is highly recommended that the monitor be connected directly to the AC power source, preferably on its own circuit. The AC power connection should be completed with UL listed 3-conductor wire (minimum 16 AWG), rated 300 VAC at 105°C.

Locate a convenient service knockout and install electrical conduit in the typical manner.

Locate the AC input terminals and ground stud on the inside of the monitor. Secure the incoming AC power neutral (white/blue) and live (black/brown) wires to the LINE 1 and LINE 2 terminals.

Using the supplied crimp-on ring terminals, washers, and nuts, connect the incoming AC power ground wire (green) to the monitor's AC input ground stud, and then install a separate wire between the ground stud and the GND terminal.



WARNING: Electrical installation should be performed by a certified electrician, and must comply with all applicable NEC/CEC and local electrical safety codes.



WARNING: Copper conductors for connection to supply mains must be made in accordance with NEC/CEC and local codes.



WARNING: The AC power ground wire must first be connected to the monitor's ground stud. Under no circumstances should this monitor be operated without a protective ground. Doing so poses a potential shock hazard, and is also a violation of electrical safety standards applicable to this type of equipment.



IMPORTANT: Drilling holes in the MZ enclosure may damage the unit and will void the warranty. Please use the knockouts provided for electrical connections.

A switch or circuit breaker rated 1.0 A, 250 VAC must be attached to the monitor's AC power leads. This switch must also be located in close proximity to the monitor, and be in easy reach of the operator. This switch should also be clearly marked as the monitor's main AC disconnect device. The circuit breaker or switch must disconnect all current-carrying conductors (i.e., live and neutral).

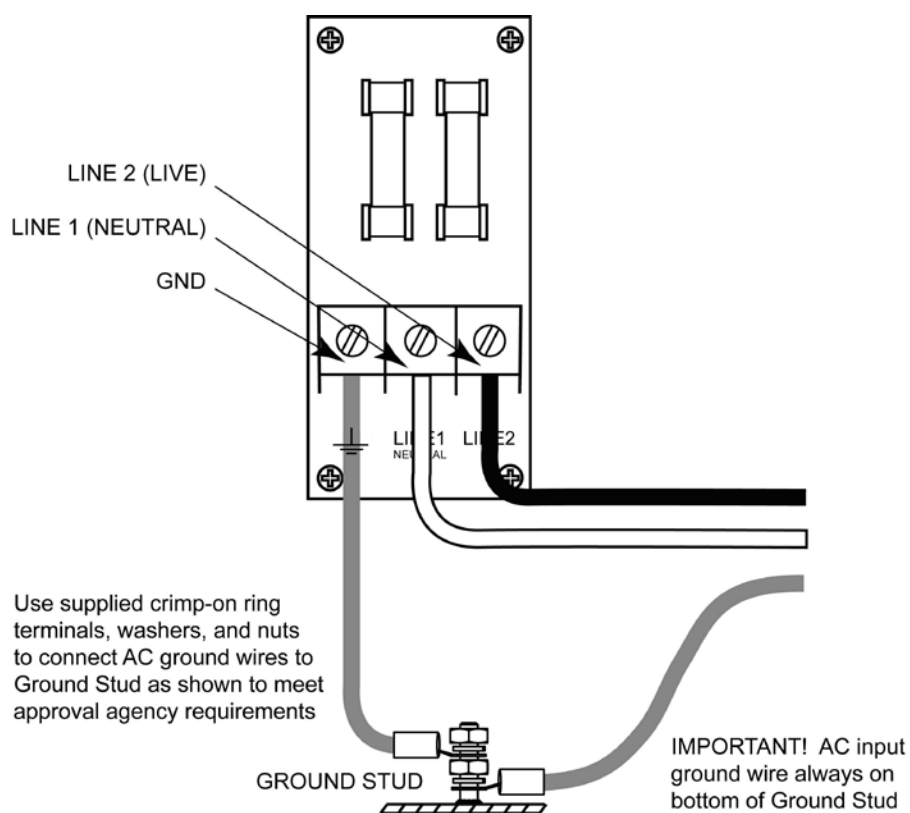

Figure 2-5. Multi-Zone AC Input Power and Ground Connections

2.5. Connecting Communications Devices

2.5.1. Remote Display Module (RD) Connection

The MZ is connected to the optional RD using a shielded twisted pair instrument cable. The maximum distance between the farthest MZ and RD is 4500 feet.

Use any of the remaining service knockouts to gain access to the interior of the monitor. The RS-485 communications wiring between the MZ and RD must be connected in the following manner:

1. Locate the RS-485 connector in the MZ (see Figure 2-3 on page 13).
2. Connect one lead of a twisted shielded pair to the “B” connection point. Note the wire color.
3. Connect the second wire to the “A” connection point. Note the wire color.
4. Connect the ground to the “GND” connection point.
5. Locate the RS-485 connector marked “TO MONITORS” in the RD (see this topic in the RD manual). This connector is located on the bottom of the RD PC board, second from the right.
6. Run the wire to the RD and connect the twisted shielded pair to the RS-485 “TO MONITORS” connector using the same color code as used on the MZ.

2.5.2. Integrating with Building Management Systems

The MZ may be connected directly to a Building Management System using a shielded twisted pair cable. The cable from the Building Management System is connected to the RS-485 connector inside the MZ monitor. MODBUS RTU is the standard communications protocol.

Use any of the remaining service knockouts to gain access to the interior of the monitor. Locate the RS-485 connector and remove it from the circuit board. Secure the wire leads to the connector orienting them as shown in the diagram below. Check to make sure that the polarity matches the wiring to the Building Management System. When you are through securing the connections, carefully plug the connector back onto the circuit board.

2.5.3. Larger Integrated Systems

You may also connect the MZ monitor to a Building Management System through a Remote Display. In this case, first connect the MZ to the RD as described above. Then, follow the instructions in the *Communications Connections* section of the RD manual for information on how to connect the RD to a Building Management System.

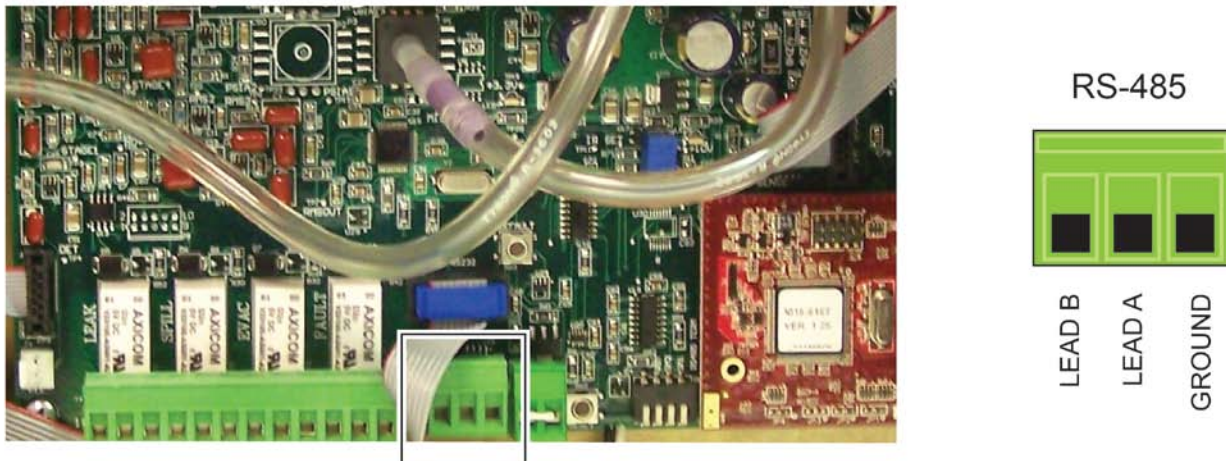

Figure 2-6. RS-485 Connector

2.5.4. Changing Terminator Switch Settings

The terminator switch is shipped from the factory in the “OUT” position (no termination). This is the correct setting if the MZ is to be installed in the middle of a network. If the MZ monitor is connected as a single device or if it is the last device on the network chain, the terminator must be moved to the “IN” position.

Locate switch #4 and determine its position. If it must be moved, slide the switch to the appropriate position. (Note that switches 1-3 are for service use.)

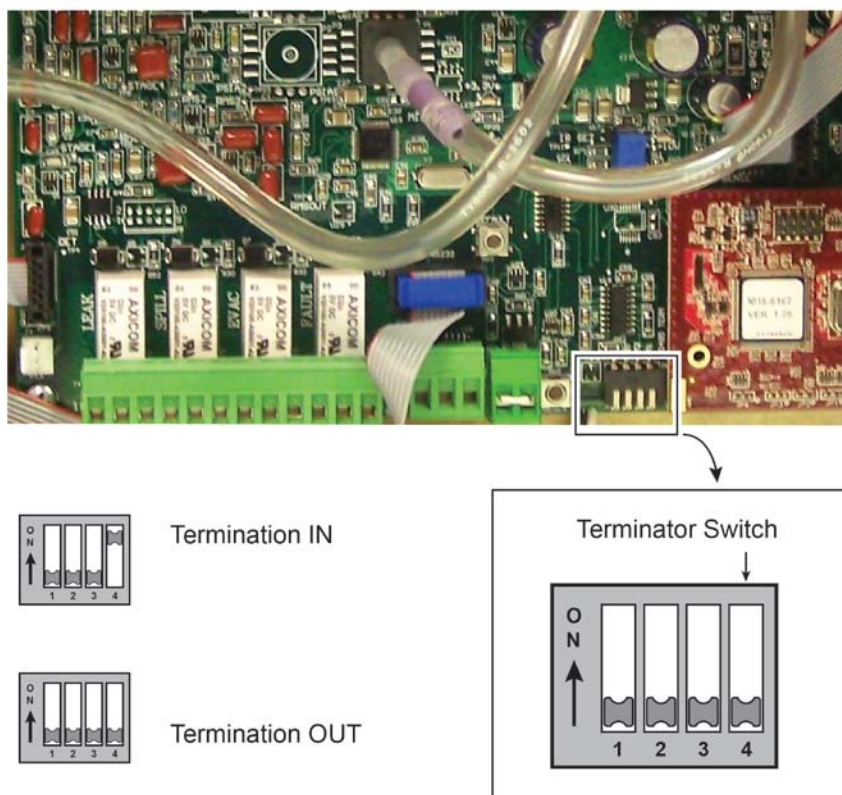

Figure 2-7. Termination Switches

2.5.5. Personal Computer

The MZ may be connected to a personal computer using the RS-232 interface on the left side of the enclosure. Software will be provided upon request or as a download from the Bacharach website at <http://www.MyBacharach.com/downloads.htm>.



NOTE: Refer to the “PC Software” section (section 2.8 on page 18) for details.

2.6. Terminating Multiple Monitors

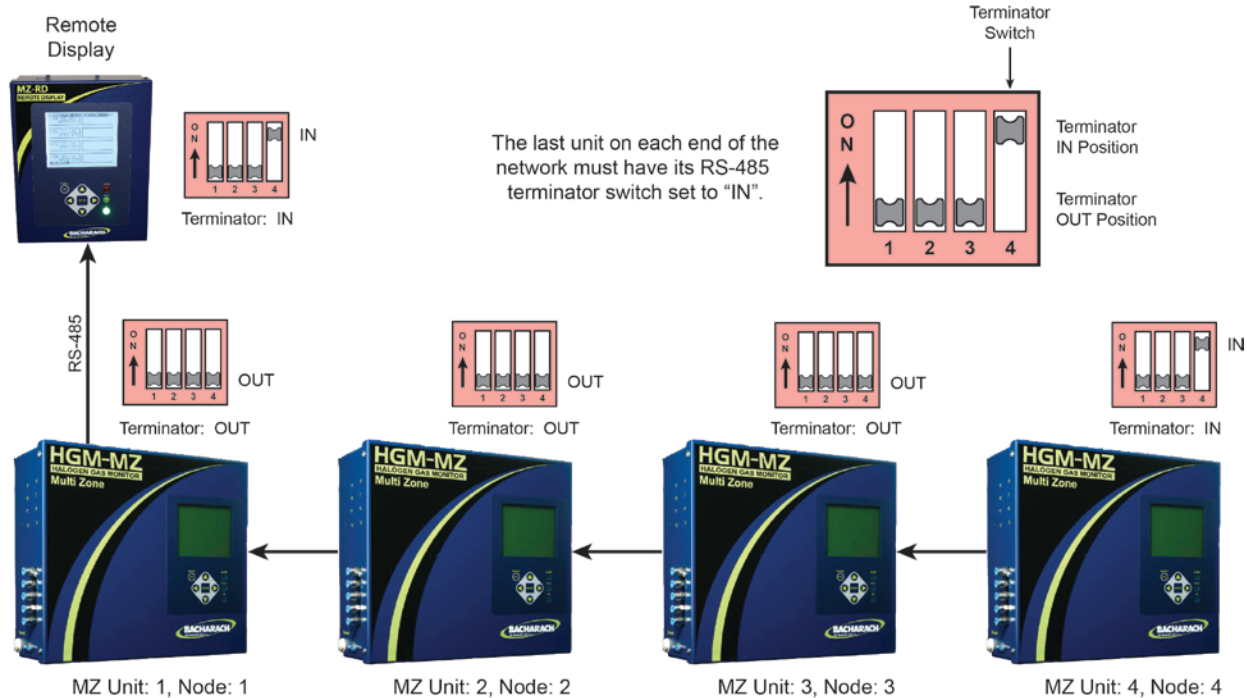

Figure 2-8. Termination Settings for a Network of Multiple Monitors and a Remote Display



NOTE: For multiple MZs with Remote Display, the last MZ or RD on either end of the network must have its terminator in the "IN" position, and all other units must have their terminators in the "OUT" position.



NOTE: For multiple MZs with Remote Display, the total length of the RS-485 cable cannot exceed 4500 feet (1372 m). (Use instrument cable 20 gauge multi-strand shielded and twisted pair – similar or equal to Belden cable #8762.)

2.7. Connecting to a Building Management System

The MZ monitor may be connected to a Building Management System via the RS-485 connector. The node address on each MZ monitor may be set from 1 to 15 in order to identify itself to the Building Management System.



NOTE: Building Management Systems set to a 0 or 1 address both respond to messages from the RD as address 1, therefore you should not have a unit set to 0 and another set to 1 on the same network.

If the MZ network is connected directly to a Building Management System it **may not** be connected to the RD. However, the RD has two communications ports, an "upstream" port (labeled BMS) and a "downstream" port (labeled TO MONITORS). A BMS node may be connected to the upstream RD port while the downstream RD port talks to the MZ monitors. In this case, the BMS is talking "through" the RD to the MZ monitors, but not physically on the MZ/RD network.



NOTE: User must have two (2) dedicated ports to successfully complete the required setup.

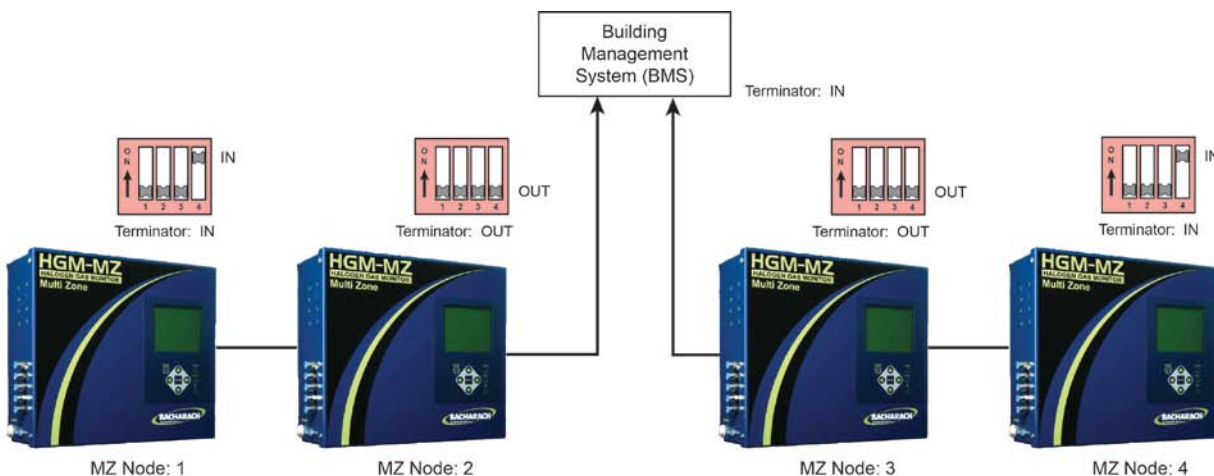

Figure 2-9. Termination Settings for Multiple Monitors Connected to a BMS (Two Trunks)

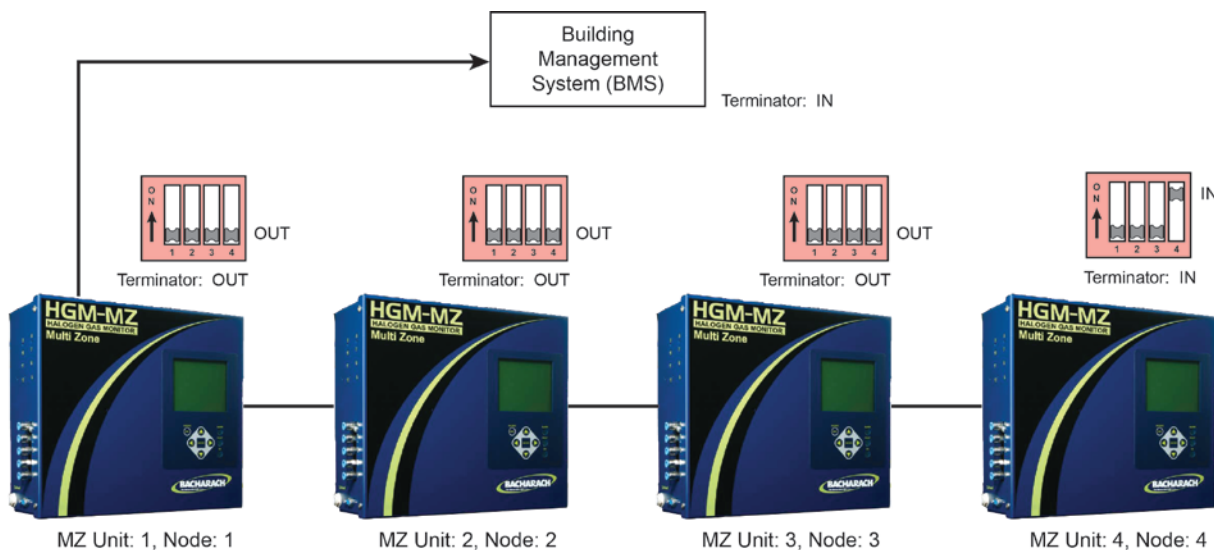

Figure 2-10. Termination Settings for Multiple Monitors Connected to a BMS (Daisy Chain)

2.8. PC Software

2.8.1. Operation



NOTE: The MZ is compatible with HGM300 PC software version 1.52 and higher. However, calibration data can only be edited on the front panel of the MZ, not through the PC software or RDM units.



NOTE: The PC software is not compatible with 64-bit (or newer) computers.



NOTE: The PC software uses COM1 by default. Therefore, the interface cable should be connected to the port configured as COM1 on the PC. Also, no other software drivers or devices in the computer may control COM1 when the MZ software is in use. Alternatively, COM2 (for example) may be used by adding a space and the number 2 to the command line as follows:

C:\pc2HGM.exe 2

When using a USB to serial converter, be sure it has been mapped to COM1 or COM2.

The connection is made through a standard “straight through” serial port connection. A three-wire connection is used (RXD, TXD, and GND). No hardware flow control is used. The MZ software automatically configures COM1 to match the MZ RS-232 communications parameters.



NOTE: Occasionally, the laptop connection will not connect properly and only two beeps are heard and the program times out. To resolve this, disconnect the RS-232 cable and cycle power on the MZ and the laptop. After both are operational, connect the RS-232 cable and start the software program.

1. Apply power to MZ monitor and allow it to warm up. Note that on CO₂ models, a “Clearing Purge Line” message is displayed for approximately 2.5 minutes before warm up begins.
2. Connect RS-232 interface cable to the PC and RS-232 port on the MZ monitor.
3. Insert software disk into the PC.
4. Open the MZ software using Windows Explorer.
5. Upon start up, the program will immediately attempt to download data from the MZ, as indicated by several beeps.

Navigate using your PC keyboard:

- Use the **up, down, left, and right arrow** keys to navigate through the screen options.
 - Use the **Enter** key to select options.
 - Use the **Esc** key to go back one step.
6. Go to EDIT. From the EDIT Menu, select SYSTEM. The monitors’ LOCATION becomes highlighted. Press **Enter** to move to the TAG area. Use the **Backspace** key to remove the existing tag. Enter a new tag. Press **Enter** to return to LOCATION. Select the next item to be addressed. Note that you cannot change the “SN” or “FIRMWARE” items. Press the **Esc** key to return to the menu bar.
 7. Go to EDIT. From the EDIT Menu, select ZONES. Select a specific zone to identify and set parameters. When REFRIGERANT is selected (Halogen Monitor), scroll through the gas library to locate and select the gas type for that zone.
 8. Setting the Alarms: Select EVAC LEVEL. Use the **Backspace** key to clear previous setting. Type in the new PPM level. Use the same method to set the spill level and leak level.
 9. To close or bypass a zone: Set the DISTANCE to 0 feet.



IMPORTANT: When a modified parameter (zone, system, or calibration) is sent to the MZ monitor, please wait for the computer software to indicate that the download is complete before continuing with any further edits.

2.8.2. Saving and Sending Programs

- When saving to your computer, the program will automatically add “.cfg” to the filename you have entered.
- To send a saved program to the MZ, open the program and connect the PC to the MZ. From the monitor, select SEND SETUP and press **Enter**. The saved program will be sent to the MZ.

2.8.3. Trend Data



NOTE: Creating a trend data file must be done while connected to the MZ.

From the computer, select GET TREND DATA. Select the zone that you want to trend and press **Enter**. The trend data will appear in a list format. Press **Enter** again to access the file name screen. Type the file name in for that particular zone. Press **Enter**. The file will be saved as a text file that can be converted to an Excel file or printed as is.



NOTE: The TREND file must be saved zone by zone, with a filename per zone.

2.8.4. Converting the TREND Text File to a Microsoft Excel File

Open Excel and the desired file. Select “Delimited” format and “Space” as the delimiter. Select “General” as the column data format. The text file will display as an Excel file. When saving, change the file name extension to “.xls”. Comments or notes may be added to this file as needed and saved.

2.8.5. Saving and Printing Screens and Logs

Open the software while connected to the MZ. After the software receives the program, open the desired screen (e.g., software screen, alarm log, fault log, diagnostic screen, etc.). Use the **Alt** and **Print Screen** key combination on the PC keyboard to capture the image and paste it into a Word document. Save and print. This is the last thing that needs to be done.

2.8.6. USB Type Laptops

Some laptops have USB ports and no RS-232 9-pin ports. A USB-to-serial converter or PCMCIA-to-serial converter will be required if a PCMCIA slot is available. You will be required to purchase a PCMCIA card that provides an RS-232 output. This is necessary for Windows Vista and higher versions. We recommend the PCMCIA card manufactured by:

SEALEVEL SYSTEMS, INC.
155 TECHNOLOGY PLACE
P. O. BOX 830
LIBERTY, SC 29657
PHONE – 864-843-4343
www.sealevel.com

Reference part numbers 2105R USB-to-RS232 or PC-SIO-232 PCMCIA card. A “straight through” RS-232 cable and a DB25-to-DB9 adapter will be required to connect the laptop to the HGM-MZ.

2.9. Optional Current Loop Interfaces



NOTE: The two-output, current loop interface is an option that **MUST** be ordered separately.

2.9.1. Optional 4–20 mA DC Outputs

Upon installation of the optional 4–20 mA DC Interface Board (P/N 3015-5152), the MZ has the capability of providing dual 4-20 mA DC scrolling current loop outputs for connection to external monitoring devices (e.g., a local loop-powered display or a building management system [BMS]).



IMPORTANT: Loop outputs are powered internally. Do not use an external power supply as this can damage the loop card.



NOTE: Optional remote loop-powered displays are available to view the 4-20 mA outputs.

The interfaces are set up as follows:

- Loop 1 indicates zone area
- Loop 2 indicates PPM.

The 4-20 mA outputs are scaled to correspond to individual zone numbers and PPM concentrations. Scaling for the 16 (maximum) zone numbers is fixed (see table below). The default scaling for the PPM concentrations provides a 0-1000 PPM range for the 4-20 mA output, although it can be adjusted through the LOOP2 FACTOR option in the SYSTEM SETUP screen. Refer to the tables below.

Loop 1 = Zone

Output	Zone
4 mA DC	n/a
5 mA DC	1
6 mA DC	2
7 mA DC	3
8 mA DC	4
9 mA DC	5
10 mA DC	6
11 mA DC	7
12 mA DC	8
13 mA DC	9
14 mA DC	10
15 mA DC	11
16 mA DC	12
17 mA DC	13
18 mA DC	14
19 mA DC	15
20 mA DC	16

Loop 2 = PPM (Default: 0.016 mA DC = 1 PPM)

Output	PPM (Default)
4 mA DC	0 PPM
5 mA DC	63 PPM
6 mA DC	125 PPM
7 mA DC	188 PPM
8 mA DC	250 PPM
9 mA DC	313 PPM
10 mA DC	375 PPM
11 mA DC	438 PPM
12 mA DC	500 PPM
13 mA DC	563 PPM
14 mA DC	625 PPM
15 mA DC	688 PPM
16 mA DC	750 PPM
17 mA DC	813 PPM
18 mA DC	875 PPM
19 mA DC	937 PPM
20 mA DC	1000 PPM

2.9.2. 4-20 mA DC Connections

External devices are connected to the MZ monitor using a shielded dual twisted pair cable. Use any of the remaining service knockouts to gain access to the interior of the monitor. Locate the dual 4–20 mA DC output connector (see below) and remove it from the circuit board. Secure the wire leads to the connector orienting them as shown in the diagram below. Check to make sure the polarity matches the wiring at the external device. When you are through securing the connections, carefully plug the connector back onto the circuit board.



NOTE: The ground connections of the 4-20 mA DC output connector are common.



NOTE: The 4-20 mA DC output connector are SIGNAL OUT ONLY. DO NOT APPLY POWER.



NOTE: It is highly recommended that a current loop isolator is used when connecting to the 4-20 outputs. Bacharach recommends the “Dataforth DSCL 21 Loop powered isolator DIN mount.” More detailed information can be found at www.dataforth.com.



NOTE: When one or both current loop outputs are not used, install a jumper wire between the ground and the unused loop terminal(s) to prevent the system from generating a current loop fault.

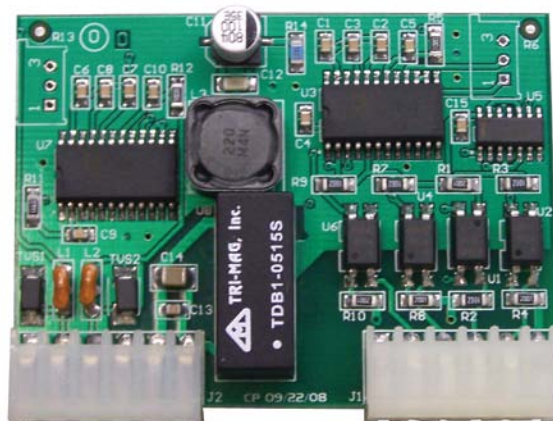

Figure 2-11. Optional Dual 4-20 mA DC Output Board for the MultiZone



CAUTION: The loop outputs have isolated grounds. Therefore the cable shield should be terminated at the receiver and **not** the MZ monitor. The signal for both current loops must be returned to the MZ monitor.

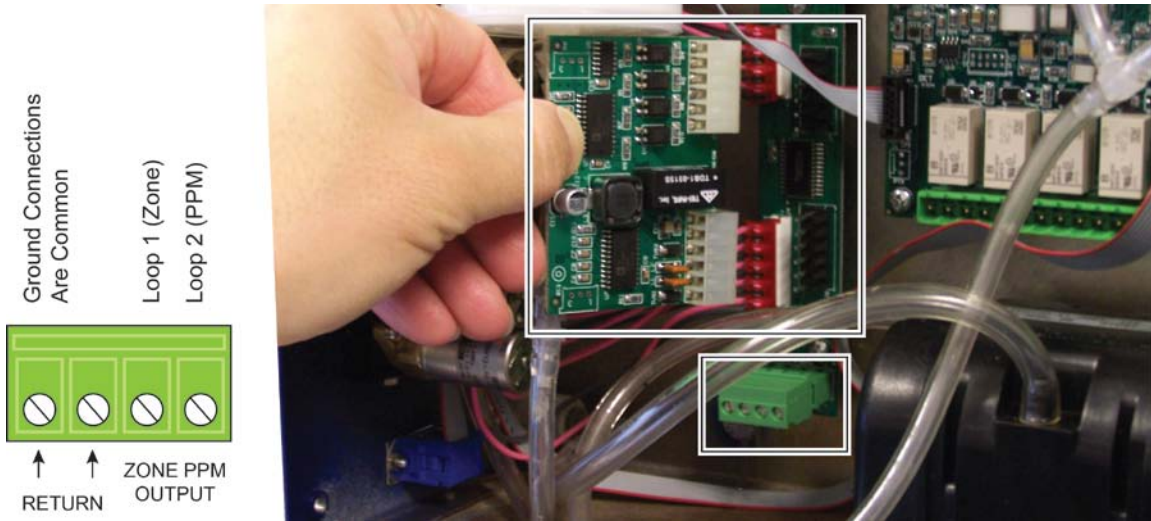

Figure 2-12. Optional Dual 4-20 mA DC Output Board and Connector

2.10. Connecting External Alarms

2.10.1. Overview

The MZ monitor includes four SPDT relays whose contacts are rated 2 A at 250 VAC (inductive) and 5 A at 250 VAC (resistive). These relays are used for the connection of external alarm devices that are activated when the relay is energized. The relays are factory assigned to energize under the following conditions:

Relay #1	Leak	Alarm Point 100 ppm
Relay #2	Spill	Alarm Point 300 ppm
Relay #3	Evacuate	Alarm Point 500 ppm
Relay #4	Fault	System Fault Event

2.10.2. Connection

Use the conduit or any of the remaining service knockouts to gain cable access to the interior of the monitor. Locate the relay connector (see Figure 2-3 on page 13) and remove it from the circuit board. Secure the leads to the connector orienting them as shown in the diagram below. When you are through securing the connections, carefully plug the connector back onto the circuit board.

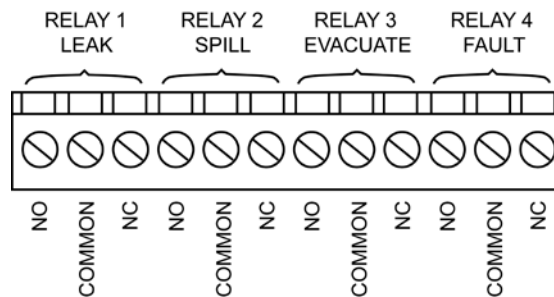

Figure 2-13. MZ Monitor Relay Connector

Each relay may be connected as normally open (NO), or normally closed (NC). The relay contacts are rated 2 A at 250 VAC (inductive) and 5 A at 250 VAC (resistive).

Power for the alarm devices connected to the relay contacts may be supplied by an external 24 VDC power source or the monitor's AC input terminals. In the first wiring diagram, power to this device is being tapped off the monitor's AC input. In the second wiring diagram, power is supplied from an external power source.

Jumper the “Live/Positive” line of an external power source (DC devices) or the monitor’s AC input (AC devices) to the “Common” terminal on the relay connector.

Connect the “Live/Positive” end of the strobe or horn to the “NO” terminal of whichever level of alarm is appropriate for the application.

For protection, install an in-line fuse of the appropriate size and design for the external alarm device being used.

The other end of the strobe or horn is connected to the “Neutral/Negative” leg of the external power source (DC devices) or monitor’s AC input (AC devices).

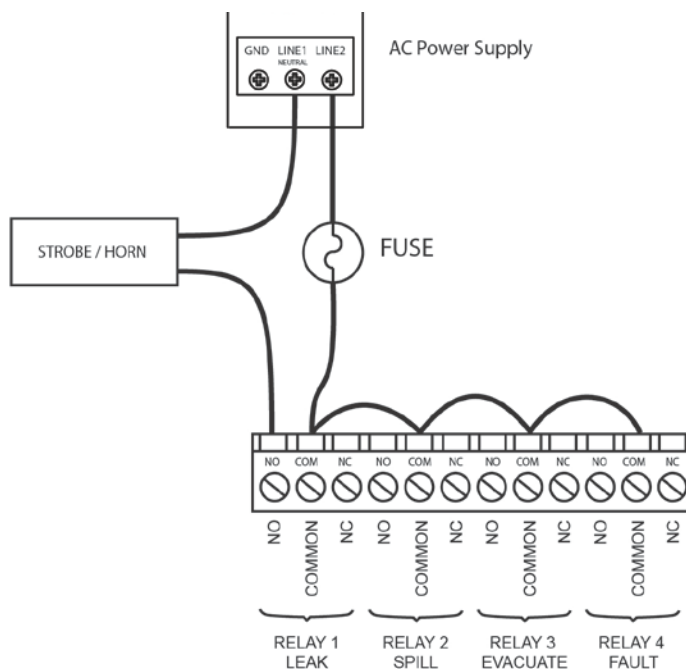

Figure 2-14. Typical AC External Alarm Relay 1 Wiring

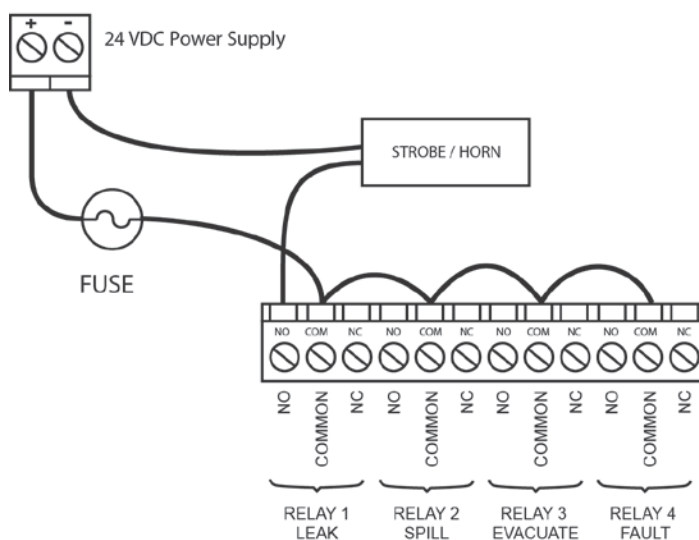

Figure 2-15. Typical DC External Alarm Relay 1 Wiring

SECTION 3. SETUP PROGRAMMING

3.1. Initial Power Up

When the MZ monitor is powered up, all front panel LEDs will illuminate and a splash screen will appear, displaying the monitor's firmware version level. Note that on CO₂ models, a "Clearing Purge Line" message is displayed for approximately 2.5 minutes before warm up begins. After a moment, the **Warm Up screen** will be displayed and the green **MONITOR ON** light will blink.

After a 15-minute warm up cycle, the **MONITOR ON** light will glow steadily and the **Data Display screen** will be displayed. (See Appendix C for an overview map of the screens in the system.)

3.2. Data Display Screen

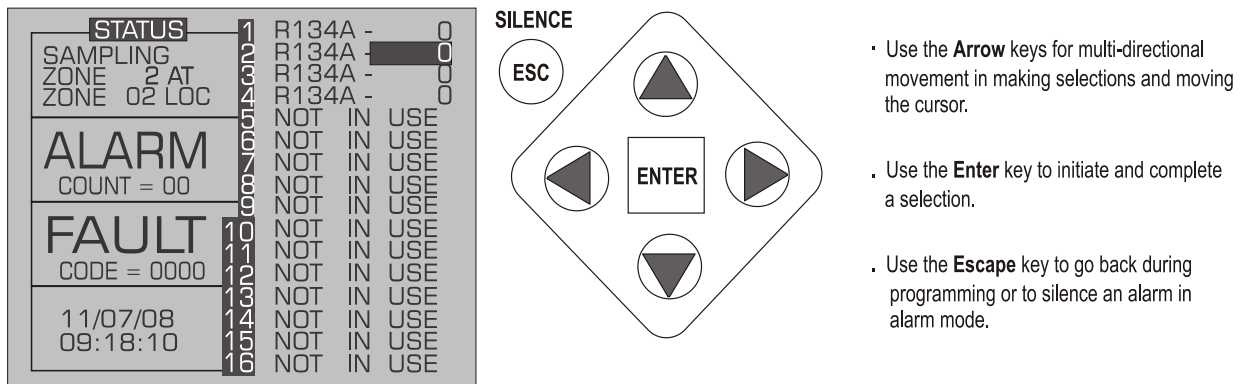

Figure 3-1. Data Display Screen and Front Panel Keypad

3.3. Navigating to the 1st Setup Screen

From the Data Display Screen, press the UP or DOWN arrow key. **SETUP** will be highlighted in the first box. Press **ENTER** to select this option and display the **Setup** screen (see below).

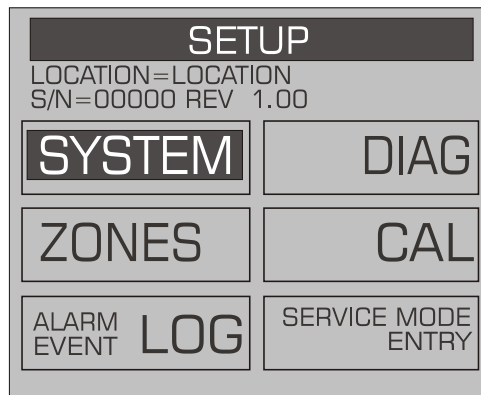

Figure 3-2. System Setup Screen #1

3.4. Navigating to the 2nd Setup Screen

From **System Setup Screen #1**, select the **SYSTEM** option to go to **System Setup Screen #2**. Select the **ESC** key to return to the **System Setup Screen #1**.

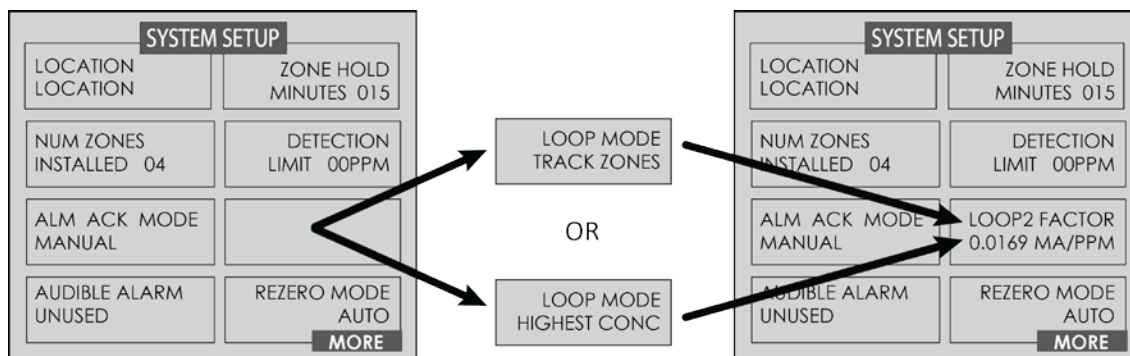

Figure 3-3. HGM System Setup Screen #2

3.4.1. Location

This is the name you assign to the MZ monitor to identify its location. It may have up to 12 alphanumeric characters.

1. Press the ENTER key to adjust the setting.
2. Use the LEFT/RIGHT cursor keys to move across the entry field and the UP/DOWN cursor keys to modify the individual characters.
3. Press ENTER to accept the new entry or ESC to revert to the previous setting.

3.4.2. Number of Zones Installed



IMPORTANT: Do not change the number of zones to deactivate unused zones. Changing the number of installed zones is only necessary when manifold blocks are added or removed. Go to the individual zone that you wish to disable and set its distance to zero.

1. Press the ENTER key to adjust the number.
2. Use the UP/DOWN cursor keys to modify the number (must be 4, 8, 12, or 16).
3. Press ENTER to accept the new number or ESC to revert to the previous setting.

3.4.3. Alarm Acknowledge Mode

This function programs the relays in the unit for latching or non-latching operation.

1. Press the ENTER key to adjust the setting.
Use the UP/DOWN cursor keys to toggle between settings.

AUTO	Non-latching (Alarm relay will automatically de-energize when the gas level drops below its alarm point.)
MANUAL	Latching (Alarm relay remains energized, and will not release until the alarm condition has been manually acknowledged. Refer to <i>Acknowledging Alarms</i> on Page 35.)
2. Press ENTER to accept the new entry or ESC to revert to the previous setting.

3.4.4. Audible Alarm

This parameter selects the function of the MZ monitors internal audible alarm device.

1. Press the ENTER key to adjust the setting.
2. Use the UP/DOWN cursor keys to select unused, monitor on, evacuate, spill, leak, fault, or alarm.
3. Press ENTER to accept the new entry or ESC to revert to the previous setting.



NOTE: In "Monitor On" mode, the unit will only give audible alarms on a critical fault that stops the unit from monitoring.

3.4.5. Zone Hold

Sets the length of time a zone will be monitored when the zone hold feature is activated. The default is 15 minutes. The range is 1 to 999 minutes.

1. Press the ENTER key to adjust this setting.
2. Use the LEFT/RIGHT cursor keys to move across the entry field and the UP/DOWN cursor keys to modify the individual numbers.
3. Press ENTER to accept the new entry or ESC to revert to the previous setting.

3.4.6. Detection Limit

This is essentially a squelch setting that instructs the instrument to interpret PPM readings below the designated level as 0. The range is 1 to 99 PPM.

1. Press the ENTER key to adjust the setting.
2. Use the UP/DOWN cursor keys to modify the setting.
3. Press ENTER to accept the new entry or ESC to revert to the previous setting.

3.4.7. Loop Mode

This sets the loop mode of the two optional 4-20 mA outputs. Options are:

- track zones mode (default)
- highest PPM concentration mode.



NOTE: Both LOOP MODE (for selecting track zones or highest PPM mode) as well as the LOOP2 FACTOR (for scaling the PPM output) are configured from the SETUP menu. Configure one, then press ENTER to access the other.

In *track zones mode* the MZ adjusts the ZONE and PPM outputs to correspond to the latest sampled zone number and its corresponding PPM concentration, respectively. For example, if the MZ samples zone #9 at 63 PPM, the ZONE and PPM outputs would read 13 mA (corresponds to zone #9) and 5 mA (corresponds to 63 PPM), respectively, until the next zone is sampled. This continues in a cyclic fashion through each zone. Note that this example assumes LOOP2 Factor was left at its default value (0.016). This can be adjusted through the LOOP2 FACTOR option in the SYSTEM SETUP screen.

In *highest concentration (PPM) mode* the MZ adjusts the two current outputs to correspond to the zone number that has the highest PPM concentration and the corresponding value of that concentration, respectively. Unlike *track zones mode*, this mode will adjust the two outputs to correspond to whichever zone has the highest PPM concentration. For example, if zone #9 is sampled at 125 PPM, the two 4-20 mA outputs will read 13 mA and 6 mA, respectively, as long as it continues to sample at 125 PPM or until a different zone samples a concentration greater than 125 PPM.

3.4.8. Loop2 Factor

This sets the PPM scale factor for current loop number 2. After setting the loop mode, the menu box changes to a lower-level menu that allows you to set the Loop2 Factor. To calculate the current output, multiply the scale factor by the PPM and add 4. For example, at the default scale factor of 0.016, a measurement of 100 ppm would generate a current output of 5.6 mA DC. The current output cannot exceed the 20 mA DC capacity of the interface.

1. Press the ENTER key to adjust the setting.
2. Use the LEFT/RIGHT cursor keys to move across the entry field and the UP/DOWN cursor keys to modify the individual characters.
3. Press ENTER to accept the new entry or ESC to revert to the previous setting.



NOTE: Both LOOP MODE (for selecting track zones or highest PPM mode) as well as the LOOP2 FACTOR (for scaling the PPM output) are configured from the SETUP menu. Configure one, then press ENTER to access the other.

3.4.9. Re-Zero Mode

This parameter defines the frequency at which the instrument re-zeros the optical sensor.

1. Press the ENTER key to adjust the setting.
2. Use the UP/DOWN cursor keys to toggle between settings.
AUTO Sets the instrument to re-zero every 10 minutes.
ZONE CHANGE Sets the instrument to re-zero at each zone change. This is the most accurate setting, but increases the time interval between measurement cycles.
3. Press ENTER to accept the new entry or ESC to revert to the previous setting.

3.5. Navigating to the 3rd Setup Screen

3.5.1. Overview

From **System Setup Screen #2**, select the MORE option to go to **System Setup Screen #3**. Select the BACK option to return to **System Setup Screen #2**.

The screenshot shows a menu titled "SYSTEM SETUP" with four rows of input fields. The first row is "RS485 BAUD" with the value "19200". The second row is "NODE ADDRESS" with the value "01". The third row is "PASSWORD" with the value "000". The fourth row is empty. A "BACK" button is located in the bottom right corner of the screen.

Figure 3-4. System Setup Screen #3



NOTE: The **RS485 BAUD** rate text is replaced by "Service Timeout" when in Service Mode.

3.5.2. Baud Rate

This parameter defines the baud rate for the RS-485 communications port.

1. Press the ENTER key to adjust the setting.
2. Use the cursor keys to scroll through a list of available baud rates to select the desired baud rate.
3. Press ENTER to accept the new entry or ESC to revert to the previous setting.

3.5.3. Node Address

Each monitor on the network must have a distinct node address. The node address may be set from 1 to 64.

1. Press the ENTER key to adjust the setting.
2. Use the LEFT/RIGHT cursor keys to move across the entry field and the UP/DOWN cursor keys to modify the individual numbers.
3. Press ENTER to accept the new entry or ESC to revert to the previous setting.

3.5.4. Password

This field is used to define a system password. The default setting is 000, which provides no password protection.

1. Press the ENTER key to adjust the password.

2. Use the LEFT/RIGHT cursor keys to move across the entry field and the UP/DOWN cursor keys to modify the individual alphanumeric characters.
3. Press ENTER to accept the new password or ESC to revert to the previous setting.



NOTE: After entering the password (including the 1st time it is set), the MZ begins a 30-minute “inactivity” timer that is reset every time a key is pressed. When the timer reaches zero, password access is enabled. To enable password protection *sooner*, cycle power on the MultiZone. When password protected, a password entry is required in order to view screens other than the SYSTEM or ZONE VIEW screen.

3.6. Additional Service Features

The Service Mode option is located on the System Setup Screen in the bottom right corner. When activated, the Service Mode will disable the MZ unit for a specified length of time. The default is 5 minutes. This time interval can be changed as described in the *Service Timeout* section below.



IMPORTANT: Note that while in the Service Mode no measurements are made, nor are any alarms activated.

Access the service mode options from the initial **Data Display Screen**. Press the **SERVICE MODE ENTRY** option **twice within 3 seconds**. To exit the Service Mode, again press the **SERVICE MODE ENTRY** option **twice within 3 seconds**.

Several features can be viewed on the System Setup Screen #3 when the monitor is placed in service mode. While in service mode, the user can identify the model number, set digipot values and sensor temperature, and acquire the temperature coefficient.

SYSTEM SETUP	
SERV TIMEOUT 300 MINUTES	DET DIGIPOT 180
NODE ADDRESS 01	SENSOR TEMP C 0.00000
PASSWORD 000	ACQUIRE TEMPCO
MODEL 30155043	IR DIGIPOT 124
	MORE

Figure 3-5. System Setup Screen #3 (Service Mode)

3.6.1. Service Timeout

Displayed in Service Mode. Sets the length of time the Service Mode is in effect. Stops the monitor for up to 300 minutes (5 hrs) to allow for servicing the unit.

1. Press the ENTER key to adjust the setting.
2. Use the LEFT/RIGHT cursor keys to move across the entry field and the UP/DOWN cursor keys to modify the individual numbers.
3. Press ENTER to accept the new entry or ESC to revert to the previous setting.

3.6.2. DET Digipot

The DIGIPOT function allows *manual* and a more precise adjustment of the digital potentiometer, which controls the voltage of the IR Detector. The DIGIPOT is auto tuned at every power up.

1. Press the ENTER key to adjust the setting. Once the option is selected the screen will also display the voltage.
2. Use the UP/DOWN cursor key to modify the digipot value.

3.6.3. Node Address

Each monitor on the network must have a distinct node address. The node address may be set from 1 to 64.

1. Press the ENTER key to adjust the setting.
2. Use the LEFT/RIGHT cursor keys to move across the entry field and the UP/DOWN cursor keys to modify the individual numbers.
3. Press ENTER to accept the new entry or ESC to revert to the previous setting.

3.6.4. Sensor Temperature Coefficient (For Factory Use Only)

This field is typically for factory use only. A customer *may* need to enter a temperature coefficient if the IR bench is replaced and a new temperature coefficient is supplied with the replacement bench. Note, however, changing this setting will void the calibration.

3.6.5. Password

This field is used to define a system password. The default setting is 000 (no password protection).

1. Press the ENTER key to adjust the password.
2. Use the LEFT/RIGHT cursor keys to move across the entry field and the UP/DOWN cursor keys to modify the individual alphanumeric characters.
3. Press ENTER to accept the new password or ESC to revert to the previous setting.

3.6.6. Acquiring Temperature Coefficient (For Factory Use Only)

This field is for factory use only. Changing this setting will void the calibration.

3.6.7. IR Digipot

This option indicates the electrical parameters of the infrared emitter.

3.7. Establishing the CO₂ Sensor Baseline

At power up, an automatic zeroing sequence establishes the CO₂ sensor baseline. At that time, the MZ assumes the default ambient CO₂ level of 386 ppm. However, if:

- the purge line wasn't connected to the instrument, or
- the purge line was not terminated in fresh air,

then the sensor baseline may be compromised. If you suspect that the baseline was compromised, then you can re-establish the proper CO₂ sensor baseline by ensuring the purge line is properly installed and following the procedure below.

1. Restart the monitor by either (a) cycling the power, or (b) pressing the CPU reset switch on the main printed circuit board (see Figure 3-6).

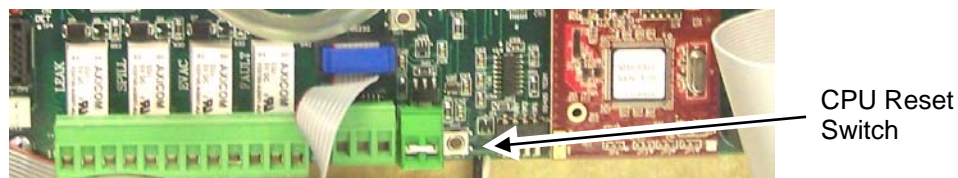

Figure 3-6. Location of CPU Reset Button



WARNING: If using the CPU reset switch to restart the instrument, extreme care should be exercised when accessing the interior of the monitor. This includes touching a non-painted area of the MZ chassis to provide proper grounding prior to touching the CPU reset switch or any other internal components. Failure to touch a grounding area can allow static electricity on your clothing or body to damage the monitor. Such damage is not covered under warranty.

2. After the restart and the warm-up have completed, the instrument is ready for use.

SECTION 4. GENERAL OPERATION

4.1. Functional Overview

Normally each MZ monitor will sequentially perform measurements on its active zones without user input. The total time it takes a MZ monitor to complete a measurement cycle is directly proportional to the number of active zones and the physical length of the air lines. Monitors linked together on a network operate independently of each other and consequently complete their respective measurement cycles at different rates.

The Remote Display operates by polling the network approximately once every 12 seconds to determine the current status of the MZ monitors. If more than one MZ is connected to the network, it will sequentially poll each monitor for its status. As a practical matter this simply means that the more complicated the network, the longer it will take the RD to update the status information for all zones.

4.2. The Zone Setup Screen

From **System Setup Screen #2**, scroll down to select the **ZONES** option.

The screenshot shows the 'ZONE 01 SETUP' screen with the following fields and buttons:

- LOC: LOCATION** (header)
- LOCATION**: ZONE 01 LOC
- TEMP AT ZONE**: 25 DEG C
- REFRIGERANT**: R134A
- 00000** (with **LAST PPM** button below it)
- DISTANCE + EXH**: 0100 FT
- LOG INTERVAL**: 0010 MIN
- TREND** (button)
- MORE** (button)

Figure 4-1. Zone Setup Screen #1

4.2.1. Location

This is the name you assign to the MZ monitor to identify the zone location. It may have up to 12 alphanumeric characters.

1. Press the ENTER key to adjust the setting.
2. Use the LEFT/RIGHT cursor keys to move across the entry field and the UP/DOWN cursor keys to modify the individual characters.
3. Press ENTER to accept the new entry or ESC to revert to the previous setting.

4.2.2. Gas/Refrigerant Type

This parameter defines the kind of gas the MZ is detecting.

1. Press the ENTER key to adjust the setting;
2. Use the LEFT/RIGHT cursor keys to select the type of gas you want the device to detect. (Options differ depending on model).
3. Press ENTER to accept the new entry or ESC to revert to the previous setting.

4.2.3. Distance + EXH

This parameter defines the combined length of the sample tubing plus any tubing on the exhaust port. Total length should not exceed 1200 ft.

1. Press the ENTER key to adjust the setting.
2. Use the LEFT/RIGHT cursor keys to move across the entry field and the UP/DOWN cursor keys to modify the individual characters.
3. Press ENTER to accept the new entry or ESC to revert to the previous setting.

4.2.4. Temp @ Zone

This parameter is used to set the expected temperature of the air at the zone being sampled. The value is used to calculate the STP PPM value shown in the diagnostic screen only.

1. Press the ENTER key to adjust the setting.
2. Use the LEFT/RIGHT cursor keys to move across the entry field and the UP/DOWN cursor keys to modify the individual characters.
3. Press ENTER to accept the new entry or ESC to revert to the previous setting.

4.2.5. Current Detection Reading

This reading displays the current PPM level of the selected gas.

4.2.6. Log Interval

The MZ retains a data log of 100 measurements for each zone. The log interval is the number of minutes from 1 to 1440 between each log point. This parameter can be changed from **Zone Setup Screen #1**.

The default setting for this parameter is 10 minutes. If the log interval time is set to 0, then a measurement is recorded in the trend log after *every measurement cycle*. Therefore, after the trend log is filled, it will contain the last 100 measurement points for a zone. If you want the data logged less frequently, increase this value. It is important to remember that cycle time is dependent on many factors, including the number of zones monitored, input line length, and the run zeroing mode selected. Before changing this value it may be useful to first review the log data using the **Trend Screen** to determine the nominal cycle time.

4.3. Navigating to the 2nd Zone Setup Screen

Select the **MORE** option at the bottom right side of the first Zone Setup screen to continue to the next screen containing more options. This screen displays the peak PPM value in the upper left side of the screen.

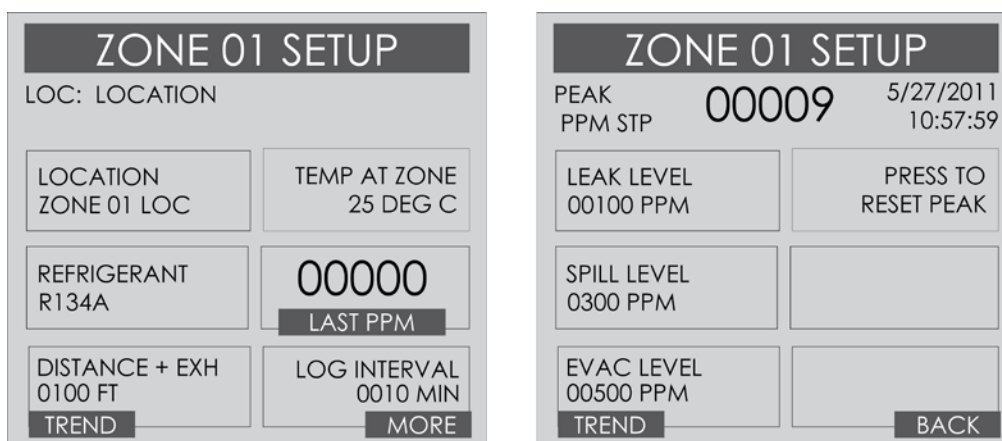

Figure 4-2. Navigating from the First to the Second Zone Screen

4.3.1. Leak Level

This is the concentration level in PPM that will activate a leak alarm condition.

1. Press the ENTER key to adjust the value.
2. Use the UP/DOWN cursor keys to modify the setting.
3. Press ENTER to accept the new entry or ESC to revert to the previous setting.



NOTE: The leak level value must be less than the spill level.

4.3.2. Spill Level

This is the concentration level in PPM that will activate a spill alarm condition.

1. Press the ENTER key to adjust the value.
2. Use the UP/DOWN cursor keys to modify the setting.
3. Press ENTER to accept the new entry or ESC to revert to the previous setting.



NOTE: The spill level value must be less than the evacuation level and greater than the leak level.

4.3.3. Evacuation Level

This is the concentration level in PPM that will activate an evacuate alarm condition.

1. Press the ENTER key to adjust the value.
2. Use the UP/DOWN cursor keys to modify the setting.
3. Press ENTER to accept the new entry or ESC to revert to the previous setting.



NOTE: The evacuation level value must be greater than the spill level.

4.3.4. Re-Setting the Peak PPM Value

Pressing this key resets the current peak PPM level stored in memory and displays it at the top of the screen.

4.4. Alarms

4.4.1. Functional Overview

If the PPM level for any zone exceeds its designated spill, leak, or evacuate thresholds, an alarm condition will be created. Once the MZ monitor completes a measurement cycle in the affected zone the alarm condition will be indicated. At that time the red ALARM LED on the MZ monitor will glow. Additionally, an external alarm device may activate and an audible alarm may sound if those features have been enabled.

The next time the RD polls the affected monitor its red ALARM LED will glow. Additionally, an external alarm device may activate and an audible alarm may sound if those features have been enabled.

4.4.2. Responding to Alarms

An operator can respond to the alarms by accessing the **Alarm Summary Screen**. Navigate to this screen by selecting ALARM on the first (**Data Display**) screen.

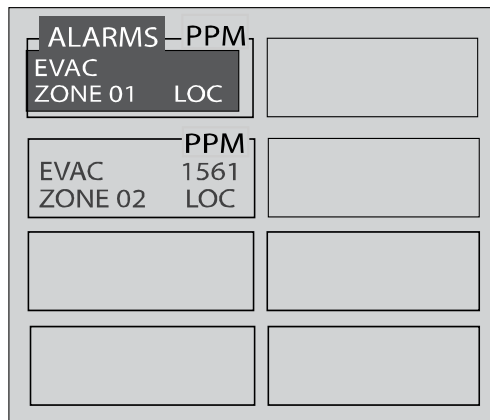

Figure 4-3. Alarm Summary Screen

The **Alarm Summary Screen** displays a list of all alarm conditions pending across the network. The screen is divided into 8 boxes, and each box represents a single alarm. If more than 8 alarms are pending, the MORE option will be displayed at the bottom of the screen to permit access to that additional information.

Each box displays the zone number, zone name, and the current PPM reading. A flashing box indicates an alarm that has not been acknowledged. A static box represents an alarm that has been acknowledged, but has not yet been cleared from the system.

4.4.3. Alarm Detail Screen

To further investigate an alarm, press the ENTER key to go to the **Alarm Detail Screen**.

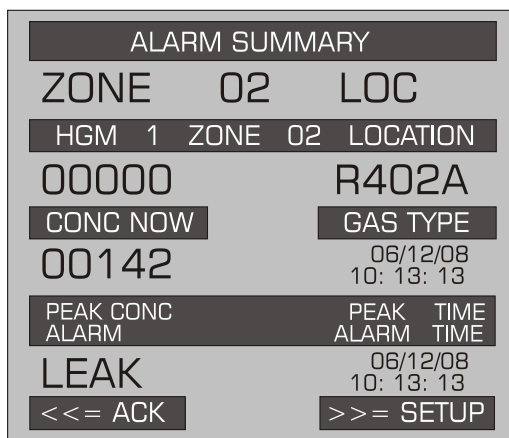

Figure 4-4. Alarm Detail Screen

The **Alarm Detail Screen** displays more comprehensive information about the nature of the alarm including:

- Complete location information
- Gas type and current concentration (CONC NOW)
- Peak concentration and peak time
- Type of alarm, alarm time, and date.

This screen provides the following navigation options at the bottom of the display:

- ACK** Using the left arrow key, acknowledges the alarm as described in the next section
- SETUP** Using the right arrow key, navigate to the **Zone Setup Screen #1**. This enables review of the zone setup parameters and access to the **Trend Screen**.

Use the ESC button on the front case to go back to the previous menu.

4.4.4. Acknowledging Alarms

Each pending alarm may require, depending upon selected alarm mode, acknowledgment before the system returns to normal operation (refer to *Alarm Ack Mode* on page 26). To acknowledge an alarm, navigate to the **Alarm Detail Screen** and select the ACK option as previously described. You will then be returned to the **Alarm Summary Screen** and the box associated with that alarm will no longer be blinking, indicating that the alarm has been acknowledged. Repeat this procedure to acknowledge any remaining alarms.

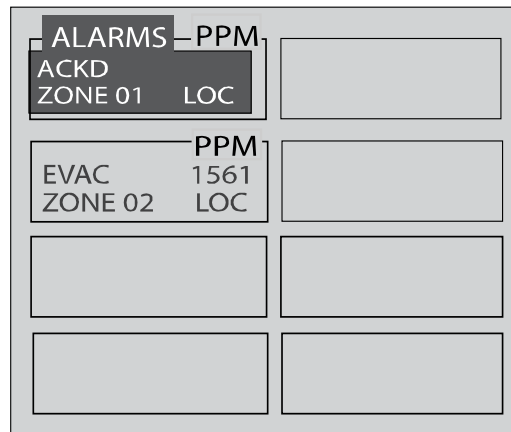

Figure 4-5. Alarm Summary Screen (Acknowledge Mode)

Once all the alarms associated with a given MZ monitor are acknowledged, its RED LED will turn off and any external alarms connected to the MZ relays will de-activate. All pending alarms across the entire network must be acknowledged before the Remote Display returns to normal operation. Once that occurs, its RED LED will turn off and any associated external alarms connected to the RD relays will de-activate.

Keep in mind that the system will continue to generate new alarms if PPM values above the alarm thresholds are detected.

4.4.5. Silencing an Alarm

When alarms are active, the ESC key functions as a silence key. During an active alarm and with the main screen displayed, press the ESC key. This will generate a prompt to "PRESS ENTER TO CONFIRM SILENCE". When ENTER is pressed, the LEAK relay will open and the internal audible alarm (if enabled) will turn off. In this way, when the LEAK relay is used to operate strobes and horns, they can be quickly silenced without effecting the SPILL or EVAC, which may be controlling fans or ventilation equipment. This "silence" mode will be indicated by a reverse flashing "S" in the alarm window. "Silence mode" will be automatically canceled if the alarm condition of any zone changes by clearing or elevating to a higher level.

4.4.6. Clearing the Alarm Event Log

A data log of the last 20 alarm events is retained in memory.

- From the **Data Display Screen**, press the UP or DOWN arrow key. **SETUP** will be highlighted in the first box.
- Press the DOWN arrow key until **Alarm Event Log** is highlighted, then press **ENTER** to select this option and display the **Alarm Event Log** (see below).

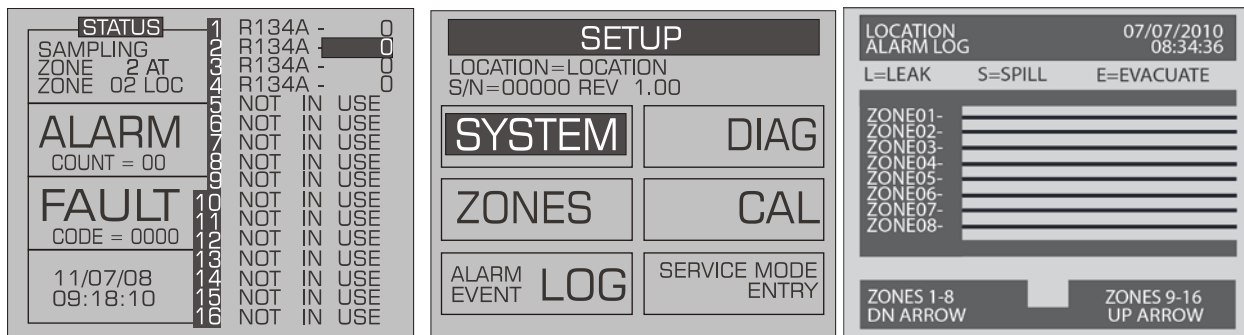

Figure 4-6. Accessing the Alarm Event Log

This screen lists zones in the left column and displays which alarms were associated with each zone as represented by the vertical cursor bar. As you move the bar horizontally using the LEFT/RIGHT cursor keys, the date and time the alarm condition was detected is displayed in the upper right hand corner of the display window.



NOTE: The Alarm Event Log can be reset by pressing a combination of the ENTER and RIGHT arrow buttons while viewing the log.

4.5. System Faults

4.5.1. Functional Overview

If a system malfunction occurs, the yellow FAULT LED will glow. Additionally, an external alarm device may activate and an audible alarm may sound if those features have been enabled (see *Connecting External Alarms* on page 23 and *Audible Alarm* on page 26).

The next time the Remote Display polls the affected monitor its yellow FAULT LED will also glow. Additionally, an external alarm device may activate and an audible alarm may sound if those features have been enabled (see *Connecting External Alarms* on page 23 and *Audible Alarm* on page 26).

Depending on the nature of the fault, the MZ monitor may or may not continue to operate normally. Under a non-critical fault condition, the MZ will continue to measure and log data, but some peripheral functions may be compromised. Under a critical fault condition, action is required for the MZ monitor to operate normally. The table on the following page lists the various fault conditions and explains what action should be taken to correct the problem. Note that the fault codes are cumulative. For example, a code <4200> is both a <4000> "REZERO VOLT TOL" and <0200> "GAIN SET FAULT" combined, indicating two simultaneous faults.

4.5.2. Navigating to the Fault Screen

Displayed on the initial **Data Display** Screen is a **Fault** option. Scroll down with the cursor key and select this option, which will introduce you to the **Fault Screen**.

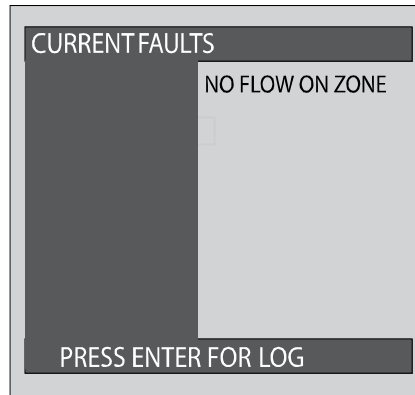



Figure 4-7. Fault Screen

4.5.3. Critical Faults

Fault	Code	Description / Possible Causes
NO FLOW ON ZONE	<0800>	<p>Go to the Data Display Screen and press the FAULT key. This will display a “NO FLOW” message in each individual zone affected. Check for a blockage in the air sample line or at the line end filter. Once the blockage has been cleared, the MZ monitor will return to normal operation after the zone has been sampled.</p> <hr/> <p> NOTE: This can take some several minutes since it is dependent upon how many zones there are and their lengths. The MZ will clear the fault the next time it polls the effected zone and the RD will return to normal operation the next time that it polls the MZ.</p> <hr/>
NO FLOW ON PURGE	<1000>	Check the purge line for a blockage. Verify that the length of the purge line and exhaust line do not exceed 500 feet in length.
CLIPPING FAULT	<8000>	The detector voltage may be out of tolerance. For information on troubleshooting this type of fault, refer to section 5.3 on page 50.
REZERO VOLT TOL	<4000>	The detector output voltage is out of tolerance. For information on troubleshooting this type of fault, refer to section 5.3 on page 50.
OVER RANGE DETECTED	<2000>	This indicates that the measured concentration on one or more zones have exceeded the measurement range. For information on troubleshooting this type of fault, refer to section 5.3 on page 50.
ZERO FILTER FAULT	<0100>	Indicates contamination in the purge air, or if a charcoal filter is in use, the filter may need to be changed.
GAIN SET FAULT	<0200>	Indicates sensor gain (digipot) is outside acceptable range. For information on troubleshooting this type of fault, refer to section 5.3 on page 50.
A2D FAULT	<0400>	Analog to digital converter not working.

4.5.4. Non Critical Faults

Fault	Code	Description / Possible Causes
BOX TEMP FAULT	<0001>	Enclosure's internal temperature is outside normal range (or IR sensor has failed). Check the installation to verify that the monitor is not being subjected to extreme temperatures. Verify that the ventilation holes are not obstructed. Refer to the Diagnostic Screen for the ZERO temperature, BNCH temperature and BOX temperature. Call the factory with this information for further instructions.
BENCH TEMP FAULT	<0002>	Optical bench is outside of normal operating range (or sensor has failed). Check the installation to verify that the monitor is not being subjected to extreme temperatures. Check the Diagnostic Screen for the ZERO temperature, BNCH temperature and BOX temperature. Call the factory with this information for further instructions.
PRESSURE SENSOR	<0004>	Manifold pressure is outside normal operating range (or sensor has failed). Check the Diagnostic Screen record ALL data. Call the factory with this information for further instructions.
RS485 FAULT	<0008>	RS-485 Communications Error.
LOOP FAULT	<0010>	This would only be displayed if the dual 4-20 mA DC option was installed and one or both current loops are open. Check the wiring to load/monitoring circuit on both 4-20 mA loops.
CONFIG FAULT	<0080>	There is an error in Setup Screen #2 – Number Zones Installed field, or in RDM Setup Screen #1 – Number of MZ monitors on Network field. Check that the number of zones installed for each MZ unit and the actual number of MZ units on the network are properly programmed. Check to ensure that the manifold solenoid cable connector in each MZ unit is securely fastened to its terminal connector. If necessary, reset to the factory default settings.

4.5.5. Reset to Factory Default Settings



IMPORTANT: Performing this function wipes out all program parameters, alarms, faults, trends and log files.

1. Press and hold down the UP and DOWN arrow keys on the MZ monitor (page 13).
2. Cycle AC power OFF then ON.
3. Hold the keys until the second beep is heard.
4. The screen will indicate "This unit has been reset to factory default conditions".
5. Release the keys.
6. Reprogram the MZ as described in this manual.

4.5.6. Clearing System Faults

If the fault condition is associated with an MZ, the monitor will return to normal operation soon after the problem is corrected. At that time the YELLOW LED will turn off and any external alarms connected to the monitor's alarm relays will also turn off. The RD will return to normal operation the next time it polls the affected MZ monitor.

Once the system malfunction has been corrected it may take some time for the fault condition to clear completely. If the fault is associated with a specific zone, the MZ must first cycle back to the affected zone before it returns to normal operation. At that time the YELLOW LED will turn off and any external alarms connected to the monitor's alarm relays will also turn off. The RD will return to normal operation the next time it polls the affected monitor.

4.5.7. Viewing Fault Log

A data log of the last 20 fault conditions is retained in memory. On the **Fault Screen**, select the LOG option to view a display of the fault log.

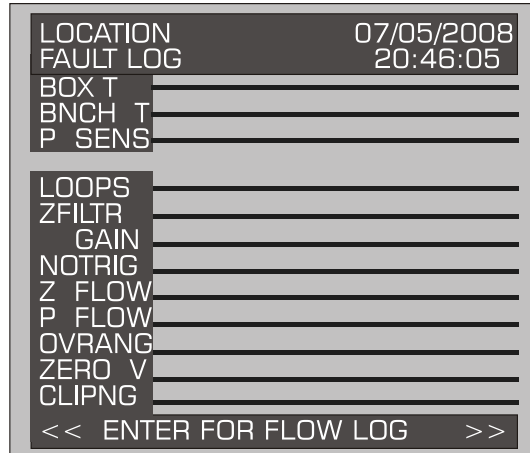

Figure 4-8. Fault Log Screen

This screen lists potential fault conditions in the left column and displays a check mark indicating which problems were associated with each fault condition as represented by the vertical cursor bar. As you move the bar horizontally using the LEFT/RIGHT cursor keys, the date and time the fault condition was detected is displayed in the upper right hand corner of the display window.



NOTE: Anytime the fault status changes, there is an entry in the fault log, both when the fault occurs and when it is cleared.



NOTE: The Fault Log can be reset by pressing a combination of the ENTER and RIGHT arrow buttons while viewing the log.

4.5.8. Viewing Flow Log

On the Fault Log screen, press ENTER to access the Flow Log screen. The Flow Log displays the last 20 flow events for all zones and the purge port.

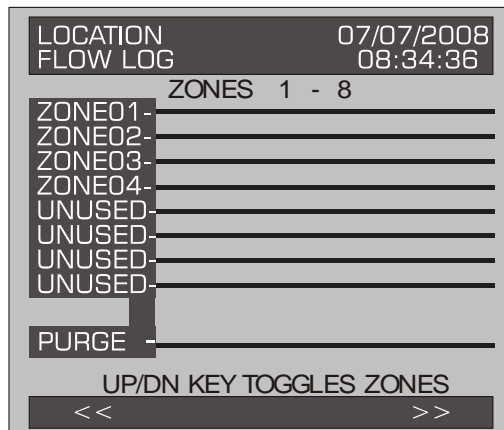

Figure 4-9. Flow Log Screen

This screen lists the zones in the left column and displays flow data. Use the UP/DOWN buttons to scroll through the zones and the LEFT/RIGHT to scroll through the log data. As you move the bar horizontally, the date and time of the condition is displayed in the upper right hand corner.

The Flow Log can be reset by pressing a combination of the ENTER and RIGHT arrow buttons while viewing the log.

4.6. The Trend Screen

4.6.1. Navigating to the Trend Screen

From the **Zone Screen**, select the **Trend** option on the bottom left side. This will open the **Trend** screen.

The trend graph opens with the cursor located over the most recent data point. Use the LEFT/RIGHT cursor keys to move the cursor to different data points. Holding a key down will cause the cursor to move rapidly across the screen. As you move the cursor position, the date and time of that reading, along with the PPM value, are displayed at the top of the screen above the graph. The trend graph is automatically scaled to accommodate the largest PPM value displayed. The ZOOM OUT and ZOOM IN options allow you to adjust the vertical scale of the graph.

The trend data is stored on a first-in, first-out basis. After 100 trend values have been stored the 101st value will replace the first value stored. Therefore, in normal operation, when entering trend mode the cursor will be located at the most recent data point. The data points to the left of the initial cursor location will be the next most recent. The data point to the right will be the oldest data point in the buffer and will be over written by the next data point.

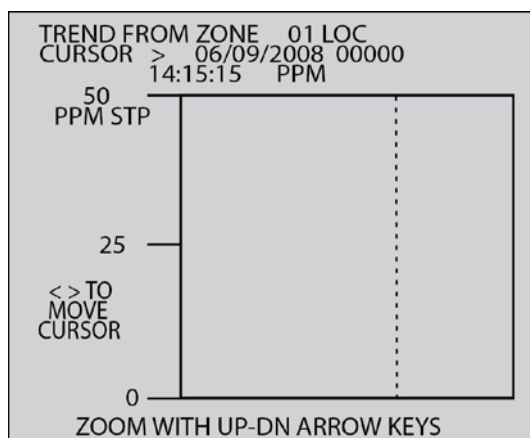

Figure 4-10. Trend Screen



NOTE: The Trend Data Log can be reset by pressing a combination of the ENTER and RIGHT arrow buttons while viewing the log.

When finished, press the ESC key to revert to the previous screen.

4.7. The Calibration Screen

4.7.1. Overview

The **Calibration Screen** is used to adjust the calibration factor for each gas. It is also used to program the instrument (Halogen only) for new gases.



IMPORTANT: Changing information on CAL FACTOR will void the factory calibration. Typically, the unit will remain within the factory-calibrated accuracy indefinitely and no calibration is required. Complex software algorithms adjust for temperature drift, IR source aging, and pressure changes in order to keep the unit within factory accuracy specifications.

4.7.2. Navigating to the Calibration Screen

On the System Setup screen, select the Calibration option (**CAL**).

Figure 4-11. Calibration Screen (HGM and AGM Only)

4.7.3. Calibration Procedure (HGM and AGM Only)

The CAL FACTOR is determined by sampling a known dilution of the type of gas to be sampled. Calibration is best performed at or near full scale. It can, however, be done at any concentration, and ideally in the range where maximum accuracy is desired down to, but not below, 100 PPM.

A cylinder of the desired gas at a certified PPM level must be used to assure sampling occurs at ambient conditions. A minimum sample size of 5 liters is required.

The MZ monitor should be operating for at least one hour prior to performing a calibration.

Prepare the MZ for sampling by initially setting its CAL FACTOR to 1.000. Next, set up the MZ for a logging interval of zero minutes, and place the MZ monitor in its zone hold mode for the zone you wish to use for calibration purposes.

Connect the sample bag directly to the intake port for the zone you have set up and allow the MZ monitor to sample the entire bag. When sampling is complete, view the trend data for the zone used to sample. Read the measured PPM by placing the cursor on the spikes caused by the sample. If the bag was large enough for multiple samples, average the most stable ones.

The new CAL factor is computed by dividing the known gas value by the measured value. Typically this value will be between 0.95 and 1.05. This value is stored in non-volatile memory.

4.7.4. Adjusting Calibration Factor (HGM and AGM Only)

The factory default cal factor for standard units is 1.000. This value may be different if the high accuracy option is ordered.

Proceed as follows to adjust the current calibration factor:

1. Use the PREV GAS or NEXT GAS options to scroll through the list of gases until the gas you wish to work with is displayed.
2. Select the CAL FACTOR option to edit the value.
3. Use the LEFT/RIGHT cursor keys to move across the entry field and the UP/DOWN cursor keys to modify the individual numbers.
4. Press ENTER to accept the new entry or ESC to revert to the previous setting.



NOTE: The CO₂ calibration is a more complex, 2-point calibration. CO₂ units are factory calibrated and not intended to be calibrated in the field. Refer to screens in section 4.7.5 for CO₂ calibration screen details.

4.7.5. CO₂ Atmospheric Concentration

Because CO₂ is present in ambient air, a relative reading is used to determine the amount of CO₂ coming from a leak. The CAL screen offers the ability to manually enter the ambient CO₂ concentration. This value is typically in the range of 380-400 ppm, however concentrations may vary slightly based on geographic locations or other factors (the factory default setting is 386 ppm).



IMPORTANT: The ambient CO₂ level is set at the factory to 386 ppm and will likely not need to be changed. If, however, the ambient CO₂ concentration at your location is known to be a value other than this default value, then the instrument's ambient CO₂ setting may need to be changed.

If needed, adjust the ambient CO₂ concentration as follows:

1. From the SYSTEM SETUP menu, navigate to the CAL screen.
2. Ensure the GAS TYPE setting is selected (see Figure 4-12) and press ENTER.
3. CO₂ calibration curve options are displayed. Simply press ENTER to access the ambient CO₂ concentration setting (PPM IN PURGE). See Figure 4-12.
4. Use the UP/DOWN cursor keys to modify the numbers to set to the appropriate value.
5. Press ENTER to accept the new entry or ESC to revert to the previous setting.

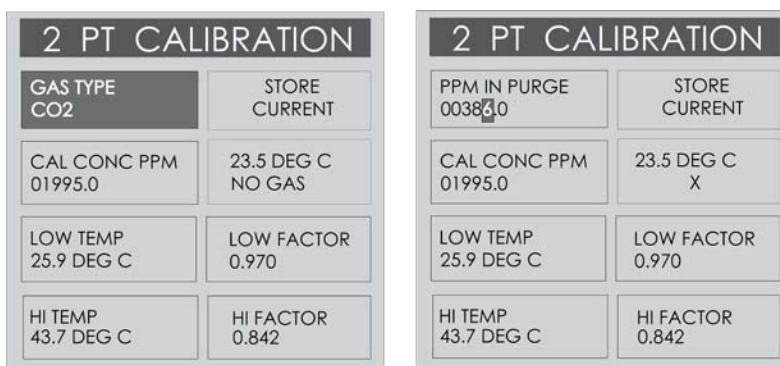

Figure 4-12. Accessing the CO₂ Atmospheric Concentration Setting (PPM IN PURGE)



IMPORTANT: Do not alter any other parameters within the Calibration Menu as this will alter the factory calibration.

4.7.6. Programming New Gases (HGM Only)

As new gases come into use the MZ monitor allows the addition of these new gases to its on-board gas library. At the end of the gas library list is an option labeled CUSTOM for adding new gases. From the **Calibration Screen** use the LEFT/RIGHT arrows to select CUSTOM from the list of gases. Next, press ENTER, and use the UP/DOWN arrow keys to enter the calibration factor. The selection of the matching gas and CAL factor is performed by Bacharach by analyzing the new gas. Once the matching gas is determined, field calibration is possible by using the same procedure as for other gases. When the new gas entry is complete simply setup the appropriate zone for CUSTOM.

Program the instrument for a new gas as follows:

1. From the **Calibration Screen**, use the PREV GAS or NEXT GAS options to scroll through the list of available choices until the CUSTOM option is displayed.

The screenshot shows a screen titled "CALIBRATION". Below the title, it says "LOCATION = LOCATION". There are two columns of options. The left column has "REFRIGERANT" and "CUSTOM". The right column has a blank box. Below these, there are two more rows. The left row has "CAL FACTOR" and "1.000". The right row has a blank box. At the bottom, there are two buttons: "<<= PREV GAS" and ">>= NEXT GAS".

Figure 4-13. Custom Gas Screen (HGM Only)

2. Select the CUSTOM option. Press ENTER to accept the new entry or ESC to revert to the previous setting.
3. Enter the new CAL Factor as received from Bacharach.

4.8. Zone Hold Mode

A zone can be placed on hold and continuously monitored for a length of time determined by the Zone Hold Time value. To place a zone on hold, select the zone at the main run screen, then press and hold down the ENTER key until the unit beeps. The word "HOLDING" will appear in the status box.

While in the hold mode, further investigation of the zone's status can be made by navigating to that **Zone's Setup Screen #1**. To release the zone from the hold mode, press and hold down the ENTER key until the unit beeps and the screen display returns to normal.

4.9. The Diagnostic Screen

4.9.1. Navigating to the Diagnostic Screen

On the **System Setup** screen, select the Diagnostic option (**DIAG**).

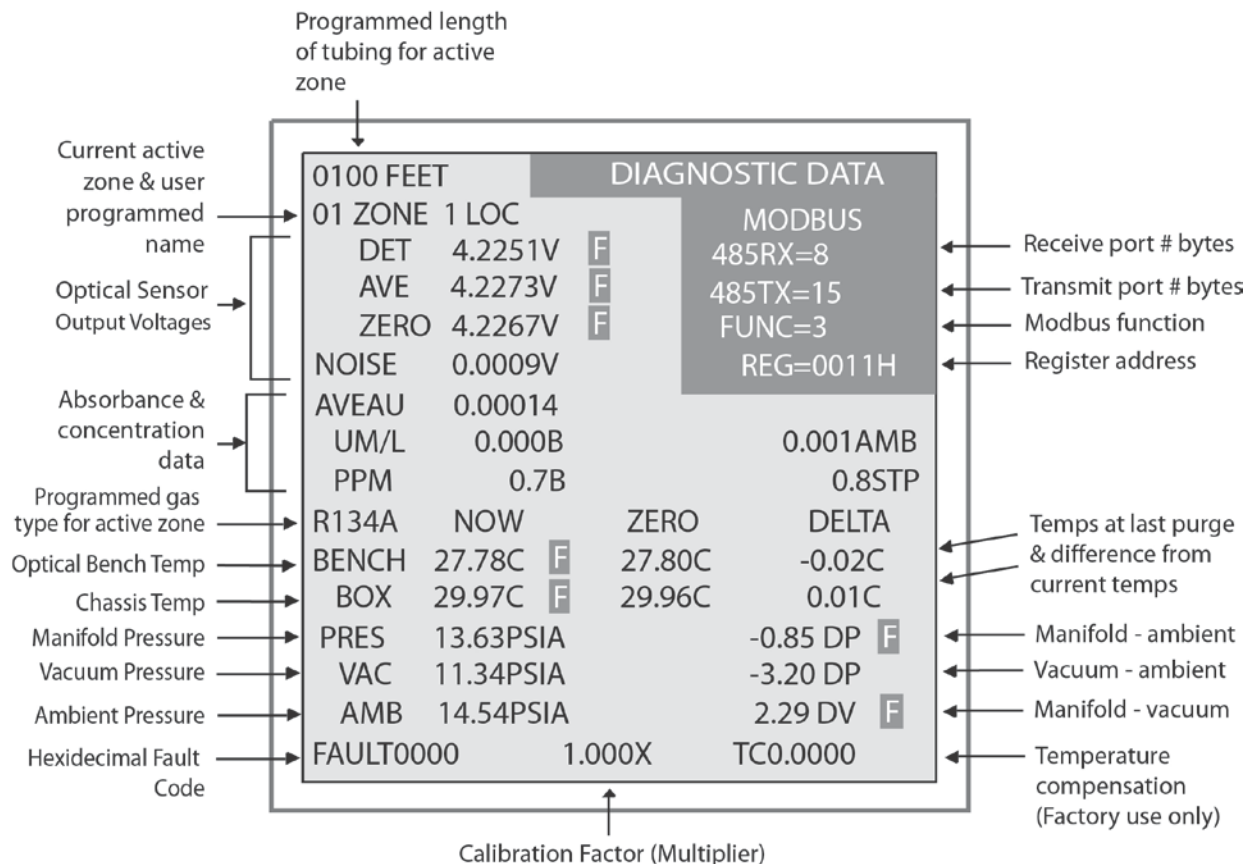

F Indicates parameter is out of tolerance & causing a fault condition.

Diagnostic Options & Controls

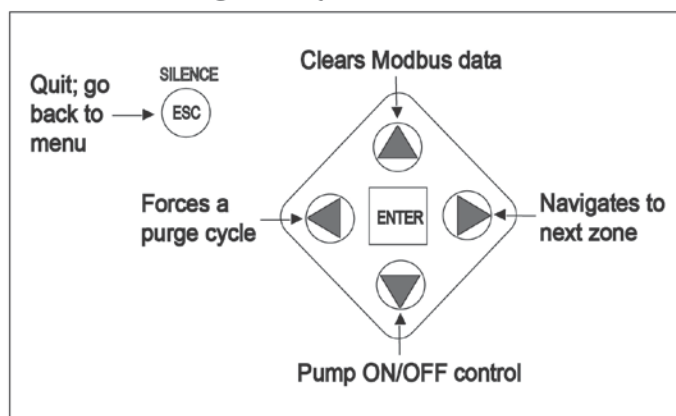

Figure 4-14. Diagnostic Screen

4.9.2. Diagnostic Screen Overview

The **Diagnostic Screen** contains sensor data and status information useful for trouble shooting various fault conditions. An explanation of the information provided on each line of this screen is listed below, including normal operating ranges.

Field Name	Description
xxxx FEET	Programmed length of tubing for an active zone.
xx ZONE <i>name</i>	Current active zone and user-programmed name. This field may also show "WARM UP" during warm up mode.
DET	Detector Voltage – Peak-to-peak output of the IR sensor. In the absence of gas, this value range is 4.100V to 4.300V.
AVE	Average Detector Voltage – Running average of the values displayed in line 1.
ZERO	Zero Voltage – IR sensor output that was stored during the last purge cycle and has the same range as line 1.
NOISE	A 16 point running average of the noise portion of IR bench output. This reading is valuable mostly when gas is not present.
AVEAU	Average Absorbency – Optical absorbency computed from the Average Detector Voltage and Zero Voltage. In the absence of selected gas, the absorbency is 0.000AU. When sampling desired gas, its value varies proportionally with the gas concentration.
UM/L	uMoles/L – Absolute concentration in micro-moles per liter of gas based on Noise and the internal calibration. There are two figures displayed. The first (annotated by a B) is the actual measurement at the IR bench. The second is the calculated value corrected to ambient conditions (temperature + pressure).
PPM	Parts Per Million is the volume concentration referenced to standard temperature and pressure and is computed from the Average Absorbency, Zero Temperature and Ambient Pressure. There are two figures displayed. The first (annotated by a B) is the actual PPM at the IR bench. The second is a PPM reading normalized to standard temperature and pressure.
ZERO	Zero Temperature – Displays the sensor and enclosure temperature measured and stored during the last purge cycle in degrees C.
BENCH	Bench Temperature – Current IR sensor temperature in degrees C as well as the raw voltage coming from the temperature sensor. This value can range from ambient to ambient +15 degrees C.
BOX	Box Temperature – This is the current internal enclosure temperature along with the raw voltage from the temperature sensor, and has the same range as the Bench temperature.
PRES	Pressure – This is the current absolute manifold pressure in PSIA along with the output voltage of the pressure sensor. This value should always be 0.2 to 1.0 PSIA below ambient (AMB).
VAC	Vacuum – The vacuum pressure is measured every purge cycle by closing all sample valves. Its value is typically 2.5 to 4.0 PSIA below ambient pressure.
AMB	Ambient – Ambient pressure is measured every purge cycle with the sample pump off and the manifold open. Its value is weather and altitude dependent and can range from 10.0 to 15.5 PSIA.
FAULT	Fault code listed in hexadecimal. See Fault Code list.
y.yyyX	Calibration multiplier used when measuring concentration.
TCx.xxxx	Temperature Compensation – magnitude of voltage applied to sensor output (in volts). Factory use only.
MODBUS data	485 RX=x Receive port number of bytes 485 TX=x Transmit port number of bytes FUNC Function REG=xxxxx Register address

SECTION 5. MAINTENANCE

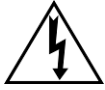

WARNING: Shock hazard! Always disconnect AC power before opening the enclosure of the monitor.

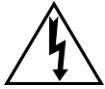

WARNING: The AC power ground wire must first be connected to the monitor's ground stud. Under no circumstances should this monitor be operated without a protective ground. Doing so poses a potential shock hazard, and is a violation of electrical safety standards applicable to this type of equipment.

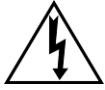





WARNING: Electrical installation should be performed by a certified electrician, and must comply with all applicable NEC/CEC and local electrical safety codes.



IMPORTANT: The MZ monitor contains sensitive electronic components that can be easily damaged. Do not touch nor disturb any components. Do not dislodge electrical wiring or pneumatic tubing.

5.1. Replacement Parts Overview

Part Name	P/N	Description
Charcoal Filter (Halogen Monitor Only)	3015-3125	The charcoal filter removes refrigerant gas from the purge-air stream during the purging process. Replace the charcoal filter (P/N 3015-3125) approximately every 6 months, when a zero filter fault occurs (fault code <0100>), or after the monitor has been exposed to unusually high levels of refrigerant gas, such as after an evacuation alarm. 
Hydrophobic Filter	0007-1650	The hydrophobic filter prevents water from entering the IR detector. A zone flow fault will occur (fault code <0800>) if this filter becomes blocked. Replace the hydrophobic filter as required (P/N 0007-1650). 
Air Line Tubing	0304-2743 0304-2742	The gas sample line and optional exhaust line should be periodically checked for obvious signs of kinks, damage and contamination. Replace the tubing as required (P/N 0304-2743 or 0304-2742 for Ammonia).
Line End Filter Assembly	3015-3420	The gas-sample line filter and purge-line termination filters prevent dust and dirt from entering the monitor. Both of the filters should be periodically checked and replaced when there are obvious signs of contamination. <ul style="list-style-type: none"> A zone flow fault will occur (fault code <0800>) if the gas-sample line filter becomes blocked A purge flow auto will occur (fault code <1000>) if the purge-line filter becomes blocked. Remove the filter from the line and replace it with a new one. 
Line End Filter	3015-2906	
End-of-Line Water Stop	3015-5512	The end-of-line water stops prevent contaminants and moisture from entering the monitor. This filter should be periodically checked and replaced when there are obvious signs of contamination. 

Multi-Zone Gas Monitors

Part Name	P/N	Description
Water Trap	0007-1655	The water trap removes moisture that enters tubing before allowing it to enter the internal components of the MZ unit. The water trap should be emptied often as condensate accumulates. The water trap filter should be periodically checked and replaced when there are obvious signs of contamination. 
Fuses	04-2620	The MZ monitor is protected from electrical damage by two, 1A, 250 V, type “F” fuses. Locate the fuse holders and carefully remove the fuses from their holders. Inspect and test the fuses with an ohm meter for continuity. Replace the fuses as required.
Clock Battery	204-0020	The clock battery maintains the correct date and time when AC power is not applied to the monitor. Replace this battery approximately every 5 years. Battery shelf life is 10 years.
Sample Pump	3015-5176	The sample pump draws the gas sample into the monitor through the IR detector and discharges the sample via the exhaust port. To replace the pump, remove the inlet and outlet tubing, disconnect the AC power wires from the pump and remove the pump from the monitor. Install a new sample pump.
Intake Manifold Kit	3015-5171	Up to three additional intake manifolds (4 zones each) can be installed in the MZ monitor to increase the total capacity to 16 zones. Each manifold requires a 4-zone line end filter kit (3015-3411). (Follow the instructions provided to install the manifolds. Then follow the instructions earlier in this manual to install the air lines and complete the zone programming steps. The MZ setup must also be updated to recognize the new zones.)
	3015-5595	Stainless steel version of 3015-5171.
4–20 mA DC Interface Board	3015-5152	The optional 4–20 mA DC Interface Board allows the operator to take advantage of the current loop interfaces provided for connection of external devices to the MZ monitor. The interface board plugs into the sockets provided on the valve/pump drive PCB, and the external devices are then cabled to the MZ monitor as described earlier in this manual.

5.2. Replacement Parts and Optional Accessories

Replacement Parts

Item Description	Part Number
Battery: Panasonic CR2032, 3V Warning: In compliance with agency approvals & safety regulations, the battery must be replaced with the specified Bacharach replacement part.	0204-0020
Filter: Charcoal, Zero Air	3015-3125
Filter: Hydrophobic (Internal)	0007-1650
Filter: End of Line – Assembly (Termination/gas sample line)	3015-3420
Filter: End-of-Line (Filter Only)	3015-2906
Filter: End-of-line water stop	3015-5512
Charcoal Filter Mounting Bracket	3015-2969
Fuse: 1.0 A, 250 V, Type “F”	0004-2620
Replacement Pump	3015-5176
Tubing: ¼ in OD (For HGM and CO ₂ ; by the foot)	0304-2743
Tubing: ¼ in OD (For AGM; by the foot)	0304-2742

Item Description	Part Number
¼" to 6 mm Reducer Kit (10)	3015-5389 (10)
¼" to 6 mm Reducer Kit (8)	3015-5390 (8)
IR Bench Replacement Kit (HGM)	3015-4572
IR Bench Replacement Kit (AGM)	3015-4492
IR Bench Replacement Kit (CO ₂)	3015-5507
Universal Power Supply	3015-5523
Main PC Board Replacement	3015-5483
Key Pad PC Board	3015-5521
Display PC Board	3015-5522
Power Entry PC Board	3015-5524
Solenoid Valve Manifold Drive PC Board	3015-5542
5 Port Solenoid Block (for HGM and CO ₂ : Zones 1-4 and purge port)	3015-5080
4 Port Solenoid Block (for HGM and CO ₂ : Zones 1-4)	3015-5072
5 Port Stainless Steel Manifold (for AGM; Zones 1-4 and purge port)	3015-5081
4 Port Stainless Steel Manifold (for AGM: Zones 1-4)	3015-5073

Optional Accessories

Item Description	Part Number
Interface Board, 4-20 mA	3015-5152
Variable Flow Regulator	3015-3849
Four Zone Expansion Kit (must order filters [3015-3411] in conjunction with kit)	3015-5171
Four Zone End-of-Line Filters Kit	3015-3411
Splitter Kit (2-way)	3015-5404
Splitter Kit (3-way)	3015-5405
Remote Loop Powered Display Assembly	3015-4992
Manifold Replacement Fittings	3015-5753
Surge Protectors	
120 V	3015-4121
230 V	3015-5530
4-20 mA	3015-4123
Alarms	
Audible/Visual 120 VAC	3015-3076
Audio-Visual Alarm, 18-28 VDC, Surface Mount	3015-5490
Audio-Visual Alarm, 18-28 VDC, Panel Mount	3015-5491
Audio Alarm, 18-28 VDC, Surface Mount	3015-5492
Audio Alarm, 18-28 VDC, Panel Mount	3015-5493
Annual Maintenance Kits	
4 Zone (5 line end filters, 1 charcoal filter, 1 hydrophobic, 3 end-of-line water stop filters)	3015-5525
8 Zone (9 line end filters, 1 charcoal filter, 1 hydrophobic, 3 end-of-line water stop filters)	3015-5526

Item Description	Part Number
12 Zone (13 line end filters, 1 charcoal filter, 1 hydrophobic, 3 end-of-line water stop filters)	3015-5527
16 Zone (17 line end filters, 1 charcoal filter 1 hydrophobic 3 end-of-line water stop filters)	3015-5528
Gases	
R-22 Gas Cylinder, 100 PPM	3015-3850
R-134a Gas Cylinder, 100 PPM	3015-3851
R-123 Gas Cylinder, 100 PPM	3015-3852
R-22 Gas Verification Kit	3015-3430
R-134a Gas Verification Kit	3015-3437
R-123 Gas Verification Kit	3015-3438
Water Traps	
Manual Drain Water Trap	0007-1655
Manual Drain Water Trap Replacement Filter	0007-1656
Manual Drain Water Trap Mounting Bracket	0007-1657
Communications Kits	
N2 JCI Metasys Communications Kit	3015-4230
LonWorks Communications Kit	3015-4231
BACnet Communications Kit	3015-5606

5.3. Troubleshooting

Certain critical faults may be corrected by checking and adjusting the detector voltage and/or emitter power. These faults include:

- CLIPPING FAULT <8000>
- REZERO VOLT TOL <4000>
- OVER RANGE DETECTED <2000>
- GAIN SET FAULT <0200>

To troubleshoot any of the above faults, use the procedure listed below.

1. With the monitor in either Warm Up Mode (flashing green LED) or Sampling Mode (solid green LED), access the Setup Menu by pressing the ENTER key twice.
2. Scroll to the bottom right of the screen to select the "Service Mode Entry" option.
3. With the "Service Mode Entry" option highlighted, press ENTER twice to enter Service Mode.
4. Scroll to the "SYSTEM" option and press ENTER.
5. Scroll to the "MORE" option and press ENTER. Note that "MORE" will flash when it is selected.
6. Scroll to and select the "IR DIGIPOT" option (see below) and press ENTER.
7. Use the UP and DOWN arrows to adjust the MW reading to 450 (or as close as possible). When at the proper value, press ESC once.

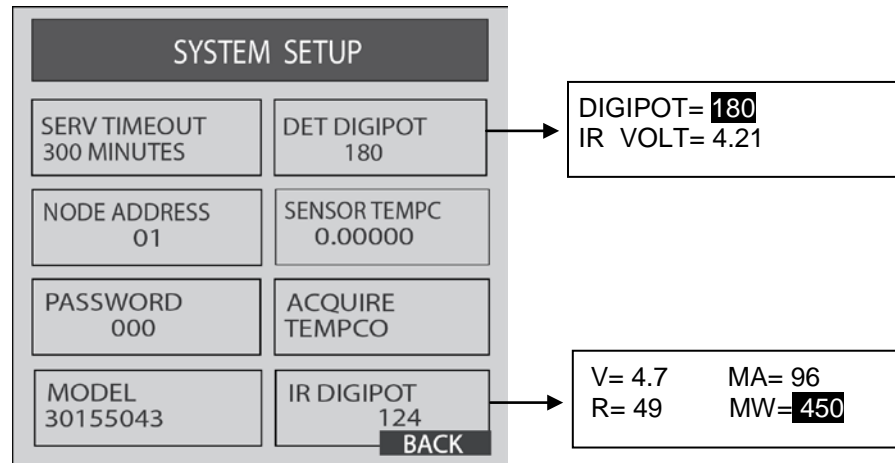

Figure 5-1. Sample DIGIPOT Readings

8. Scroll to "DET DIGIPOT" option (see above) and press ENTER.
9. Use the UP and DOWN arrows to adjust the IR VOLT reading to 4.20 (or as close as possible). When at the proper value, press ESC once.



IMPORTANT! If IR VOLT does not reach 4.200 ± 0.100 volts when adjusting the DIGIPOT, return to step 6 to lower the IR emitter setting. If the IR emitter setting is 450 ± 20 mW, adjust the new IR emitter setting to 375 ± 20 mW. Repeat step 8 with the new IR emitter setting.

10. Press ESC to save.
11. Press ESC to get to the System Menu. Scroll to Service Mode and press ENTER twice to leave Service Mode. Press ESC once and allow the instrument to complete a pressure check and purge cycle (approximately 2 minutes).

If the faults cannot be cleared using the above procedure, call the factory for further assistance.

APPENDIX A. RECOMMENDED REFRIGERANT GAS ALARM SETTINGS

Gas	Alarm Settings (PPM)		
	Leak	Spill	Evacuate
CO ₂ /R-744	1500	2000	3000
FA188	100	300	500
FC72	100	300	500
H1301	100	300	500
H1211	100	300	500
H2402	100	300	500
H1234YF	100	300	500
HFP	100	300	500
N1230	100	300	500
NH ₃ /R-717	50	150	300
R11	100	300	500
R12	100	300	500
R21	100	300	500
R22	100	300	500
R23	100	300	500
R32	100	300	500
R113	100	300	500
R114	100	300	500
R123	25	35	50
R124	100	300	500
R125	100	300	500
R134A	100	300	500
R227	100	300	500
R236FA	100	300	500
R245FA	100	300	500
R401A	100	300	500
R402A	100	300	500

Gas	Alarm Settings (PPM)		
	Leak	Spill	Evacuate
R402B	100	300	500
R404A	100	300	500
R407A	100	300	500
R408A	100	300	500
R407C	100	300	500
R409A	100	300	500
R410A	100	300	500
R422A	100	300	500
R422D	100	300	500
R424A	100	300	500
R426A	100	300	500
R427A	100	300	500
R438A	100	300	500
R500	100	300	500
R502	100	300	500
R503	100	300	500
R507	100	300	500
R508B	100	300	500
R-717/NH ₃	50	150	300
R-744/CO ₂	1500	2000	3000
H1234ZE	100	300	500
R407F	100	300	500
N7100	75	200	300
N7200	25	50	100
N7300	10	20	50
N7600	3	5	8

APPENDIX B. RS-485 COMMUNICATIONS PROTOCOL

B.1. Overview

The following instructions are intended as a guide for integrating the MZ network into a Building Management System. If you are unfamiliar with complex systems of this type, it is recommended that you contact Bacharach for technical assistance.

B.2. MODBUS RTU Protocol

The MZ monitor communicates with master devices (such as the Remote Display or a Building Management System) over the RS-485 serial interface. Because the monitor is configured with a two wire RS-485 serial bus, data transmission occurs in “half-duplex” mode. Therefore, only one device may be in transmit mode at any given time.

This document specifies the MODBUS communications protocol as implemented on the applicable instruments. Programmers should refer to the MODBUS Protocol Reference Guide for details and more comprehensive instructions. The guide is available at www.modbus.org. Specific communications software is available at: <http://www.MyBacharach.com/downloads.htm>

B.3. MZ MODBUS RTU Operation

B.3.1. Overview

The MZ and RD are equipped to communicate with other equipment using the MODBUS RTU protocol. Using this communications channel a MODBUS master device may communicate with up to 15 MZ monitors on a communications network, exchanging measurement information, alarm data, fault data, history (logs and trends) and setup information. Additionally, the MODBUS master can control the operating state of an MZ monitor, placing the MZ in any of its different operating modes. The network may be configured so that the MZ monitors are connected directly to the MODBUS master device, or the MODBUS master device may communicate with the MZs through the RD.



NOTE: This document was written with the assumption that the reader is familiar with the various setup parameters and operational modes for the Multi-Zone.

B.3.2. Protocol Details

A 2-wire RS-485 bus is used for transmission, therefore communications occurs in a Half-Duplex mode. The MZ is a slave device and will respond to queries in the MODBUS RTU format from a master device.

Three MODBUS functions are supported. They are function 03 (read holding register), function 06 (write single register), and function 16 (Preset Multiple registers – for block mode only). Please refer to the MODBUS Protocol Reference Guide (available at www.modicon.com/techpubs/techPubNew/PI_MBUS_300.pdf) for protocol detail and use instructions.

In addition to the standard register groups found in the 2000 and 3000 address ranges, a block mode access is provided for OEMs who need efficient access to the complete range of system variables using the least amount of queries. The block mode data is organized into structures (internal to the MZ monitor) which can be accessed by the MODBUS registers defined in this document. A corresponding set of data structures should be maintained by the master device. These master device data structures become the destination for responses to read queries and sources for preset register commands. When a read holding register query is made by the master device the MZ monitor responds by sending the contents of the structure referenced by the specified register. After the master validates the MZ response using the CRC bytes, it must then move the data into its matching data structure before individual items may be accessed or modified. Therefore, the master data structure should correspond to the MZ data structure byte for byte. Note that some data structures have been divided into multiple registers due to MODBUS RTU message length constraints. To change a setting in the MZ monitor, the master device first reads the register structure that contains the data item to be modified, makes the desired change, then sends the structure back using the preset multiple register function. If the transaction is successful, the MZ monitor sends the appropriate MODBUS response. It is the responsibility of the master device, when making modifications, to insure that all parameters transferred are within the working limits of the MZ.



IMPORTANT: Each time parameters are modified and sent back to the monitor using function 16 (preset multiple registers), the new values are written to the monitor's non-volatile FLASH memory. Due to the finite write life of the FLASH memory device (10K-100K write cycles), modifying and writing variables should be performed on an "as needed" basis and not periodically. Exceeding the FLASH write life can result in memory corruption, requiring a CPU board replacement.

B.3.3. MZ Monitor Polling

After the MZ monitors are setup and operating, the master device need only poll each monitor for its status register which contains summary data of the monitors' alarms, faults, and operating state. If exceptions are detected through the status register and more details are required, additional registers can be examined. Also if current PPM values are required, the PPM register provides access to current PPM values for all zones. The MZ monitor requires a minimum of 20 seconds to complete a gas concentration measurement for a single zone. Therefore, it is not necessary to poll the MZ monitor more frequently than once every 15-20 seconds, as there will not be any new data available/obtained by more frequent polling. In fact, excessive polling will slow the operation of the MZ. Under no circumstances should the MZ monitor be continuously polled at rate faster than 500 ms, as this could result in erroneous readings by the MZ monitor.

B.3.4. Network Topologies

MZ monitors may be connected directly to the MODBUS network or they may be connected to the network through a Remote Display. In either case, each MZ monitor must have a unique node ID. Up to 15 MZ monitors can be connected directly to the MODBUS network.

If MZ monitors are accessed via an RD connected to a MODBUS network, the RD "BMS enabled" parameter must be set equal to "1" via the "RDM SETUP" screen on the Remote Display. The same commands and registers are used to communicate with the MZ directly or through the RD. If the communications are through the RD, it monitors each MODBUS message to determine if the message is intended for one of the MZ monitors it is connected to. If it is, the RD passes the message through to the MZ monitors. If it is not, the message is not passed through. The RD does not make any modifications to MODBUS messages. It simply passes the query through to the MZ monitor, and passes the response back to the MODBUS master. In other words, it allows the MZ monitors to be logically connected to the MODBUS network, when physically they are connected to the local RD network.



IMPORTANT: It is very important to understand that the RD will only pass messages through to the MZ monitor when the RD is either in the "SYSTEM" screen or the "ZONE VIEW" screen. If the RD is in any other screen, it will return a MODBUS "busy" exception response (exception code 06).

All RD screens, except the SYSTEM and ZONE VIEW screens, have a 10 minute timeout interval. After this, the screen will return to the SYSTEM or ZONE VIEW screen, depending on which one was last displayed. The RD may also be password protected so that a password entry is required in order to view screens other than the SYSTEM or ZONE VIEW screen.

B.3.5. Key Comm Protocol Parameters

Parameter	Description
MODBUS Mode	RTU only
MZ Baud Rate	Default is 19,200. Programmable as defined in system data register.
Parity	No Parity
Stop Bits	Default is 1. Can be set for 2 via System data register.
Maximum Response Time	4000 ms when directly accessing the MZ monitor. 8,000 ms when accessing the MZ monitor through the RD.
Error Checking	CRC per MODBUS specifications



NOTE: All data sent out from the MZ is in “little endian” byte order (least significant byte followed by most significant byte). This should be taken into account if the master that process the data is a “big endian” type. Non-data information (starting address, number of points, etc.) follows normal MODBUS protocol, which is Big Endian.

B.3.6. MODBUS Exception Responses

The following MODBUS exception responses are supported by the unit.

- 01 Illegal Function
- 02 Illegal Data Address
- 03 Illegal Data Value
- 06 Slave Device Busy (Occurs only when MZ is connected to the bus through an RD and the RD is not in the SYSTEM or ZONE VIEW screen)

B.3.7. MODBUS Gas Enumeration

The following table provides decimal and hexadecimal MODBUS enumerations for supported refrigerant

Refrigerant Gas	DEC	HEX
CO ₂ /R-744	0	00
NH ₃ /R-717	0	00
R11	0	00
R12	1	01
R22	2	02
R23	3	03
R113	4	04
R114	5	05
R123	6	06
R124	7	07
R134A	8	08
R401A	9	09
R402A	10	0A
R402B	11	0B
R404A	12	0C
R407A	13	0D
R407C	14	0E
R409A	15	0F
R410A	16	10
R500	17	11
R502	18	12
R503	19	13
R507	20	14
R508B	21	15
H1301	22	16
R408A	23	17

Refrigerant Gas	DEC	HEX
FA188	24	18
R236FA	25	19
N1230	26	1A
R227	27	1B
HFP	28	1C
FC72	29	1D
R21	30	1E
R125	31	1F
H1211	32	20
H2402	33	21
R245FA	34	22
R422A	35	23
R422D	36	24
R427A	37	25
H1234YF	38	26
R424A	39	27
R426A	40	28
R438A	41	29
R32	42	2A
H1234ZE	43	2B
R407F	44	2C
N7100	45	2D
N7200	46	2E
N7300	47	2F
N7600	48	30
Custom	49	31

B.4. Standard Register Summary

B.4.1. Dynamic Register Summary (2000 Series; R; Function Code 03)

Register Address	Description	Type	Range
2000	FAULT CODE	UNSIGNED INT	0-65535
2001	PPM ZONE 1	UNSIGNED INT	0-65535
2002	PPM ZONE 2	UNSIGNED INT	0-65535
2003	PPM ZONE 3	UNSIGNED INT	0-65535
2004	PPM ZONE 4	UNSIGNED INT	0-65535
2005	PPM ZONE 5	UNSIGNED INT	0-65535
2006	PPM ZONE 6	UNSIGNED INT	0-65535
2007	PPM ZONE 7	UNSIGNED INT	0-65535
2008	PPM ZONE 8	UNSIGNED INT	0-65535
2009	PPM ZONE 9	UNSIGNED INT	0-65535
2010	PPM ZONE 10	UNSIGNED INT	0-65535
2011	PPM ZONE 11	UNSIGNED INT	0-65535
2012	PPM ZONE 12	UNSIGNED INT	0-65535
2013	PPM ZONE 13	UNSIGNED INT	0-65535
2014	PPM ZONE 14	UNSIGNED INT	0-65535
2015	PPM ZONE 15	UNSIGNED INT	0-65535
2016	PPM ZONE 16	UNSIGNED INT	0-65535
2017	ALARM LEVEL ZONE 1	UNSIGNED INT	0-3
2018	ALARM LEVEL ZONE 2	UNSIGNED INT	0-3
2019	ALARM LEVEL ZONE 3	UNSIGNED INT	0-3
2020	ALARM LEVEL ZONE 4	UNSIGNED INT	0-3
2021	ALARM LEVEL ZONE 5	UNSIGNED INT	0-3
2022	ALARM LEVEL ZONE 6	UNSIGNED INT	0-3
2023	ALARM LEVEL ZONE 7	UNSIGNED INT	0-3
2024	ALARM LEVEL ZONE 8	UNSIGNED INT	0-3
2025	ALARM LEVEL ZONE 9	UNSIGNED INT	0-3
2026	ALARM LEVEL ZONE 10	UNSIGNED INT	0-3
2027	ALARM LEVEL ZONE 11	UNSIGNED INT	0-3
2028	ALARM LEVEL ZONE 12	UNSIGNED INT	0-3
2029	ALARM LEVEL ZONE 13	UNSIGNED INT	0-3
2030	ALARM LEVEL ZONE 14	UNSIGNED INT	0-3
2031	ALARM LEVEL ZONE 15	UNSIGNED INT	0-3
2032	ALARM LEVEL ZONE 16	UNSIGNED INT	0-3
2033	(STATUS) MODE	UNSIGNED INT	0-3
2034	(STATUS) STATE	UNSIGNED INT	0-4
2035	RESERVED	UNSIGNED INT	0

Register Address	Description	Type	Range
2036	(STATUS) ACTIVE ZONE	UNSIGNED INT	1-16
2037	(STATUS) MAX ALARM	UNSIGNED INT	0-3
2038	(STATUS) ACTIVE ALARM COUNT	UNSIGNED INT	0-16
2039	(STATUS) ACK'D ALARM COUNT	UNSIGNED INT	0-16
2040	RESERVED	UNSIGNED INT	0
2041	(STATUS) FAULT CODE	UNSIGNED INT	0-65535
2042	(STATUS) AUDIBLE ALARM	UNSIGNED INT	0-1
2043	(STATUS) SILENCED	UNSIGNED INT	0-1
2044	(STATUS) HIGHEST CONC ZONE	UNSIGNED INT	1-16
2045	(STATUS) HIGHEST CONCENTRATION	UNSIGNED INT	0-65535
2046	(STATUS) ZONES INSTALLED	UNSIGNED INT	4,8,12,16
2047	(SENSOR) MANIFOLD PRESSURE x100	UNSIGNED INT	0-1600
2048	(SENSOR) AMBIENT PRESSURE x100	UNSIGNED INT	0-1600
2049	(SENSOR) VACUUM PRESSURE x100	UNSIGNED INT	0-1600
2050	(SENSOR) BENCH TEMP x100	SIGNED INT	0-6000
2051	(SENSOR) AVE VOLTAGE x1000	UNSIGNED INT	0-5000
2052	(SENSOR) ZERO VOLTS x1000	UNSIGNED INT	0-5000
2053	(SENSOR) AVE AU x10000	UNSIGNED INT	0-30000
2054	(SENSOR) BENCH PPM	UNSIGNED INT	0-65535

B.4.2. Dynamic Register Summary (2000 Series; R; Function Code 03)

Register Address	Description	Type	Range
3000	REFRIGERANT TYPE ZONE 1	UNSIGNED INT	0-49
3001	REFRIGERANT TYPE ZONE 2	UNSIGNED INT	0-49
3003	REFRIGERANT TYPE ZONE 3	UNSIGNED INT	0-49
3003	REFRIGERANT TYPE ZONE 4	UNSIGNED INT	0-49
3004	REFRIGERANT TYPE ZONE 5	UNSIGNED INT	0-49
3005	REFRIGERANT TYPE ZONE 6	UNSIGNED INT	0-49
3006	REFRIGERANT TYPE ZONE 7	UNSIGNED INT	0-49
3007	REFRIGERANT TYPE ZONE 8	UNSIGNED INT	0-49
3008	REFRIGERANT TYPE ZONE 9	UNSIGNED INT	0-49
3009	REFRIGERANT TYPE ZONE 10	UNSIGNED INT	0-49
3010	REFRIGERANT TYPE ZONE 11	UNSIGNED INT	0-49
3011	REFRIGERANT TYPE ZONE 12	UNSIGNED INT	0-49
3013	REFRIGERANT TYPE ZONE 13	UNSIGNED INT	0-49
3013	REFRIGERANT TYPE ZONE 14	UNSIGNED INT	0-49
3014	REFRIGERANT TYPE ZONE 15	UNSIGNED INT	0-49
3015	REFRIGERANT TYPE ZONE 16	UNSIGNED INT	0-49

Multi-Zone Gas Monitors

Register Address	Description	Type	Range
3016	LEAK LEVEL ZONE 1	UNSIGNED INT	>0 <SPILL PPM
3017	LEAK LEVEL ZONE 2	UNSIGNED INT	>0 <SPILL PPM
3018	LEAK LEVEL ZONE 3	UNSIGNED INT	>0 <SPILL PPM
3019	LEAK LEVEL ZONE 4	UNSIGNED INT	>0 <SPILL PPM
3030	LEAK LEVEL ZONE 5	UNSIGNED INT	>0 <SPILL PPM
3031	LEAK LEVEL ZONE 6	UNSIGNED INT	>0 <SPILL PPM
3033	LEAK LEVEL ZONE 7	UNSIGNED INT	>0 <SPILL PPM
3033	LEAK LEVEL ZONE 8	UNSIGNED INT	>0 <SPILL PPM
3034	LEAK LEVEL ZONE 9	UNSIGNED INT	>0 <SPILL PPM
3035	LEAK LEVEL ZONE 10	UNSIGNED INT	>0 <SPILL PPM
3036	LEAK LEVEL ZONE 11	UNSIGNED INT	>0 <SPILL PPM
3037	LEAK LEVEL ZONE 12	UNSIGNED INT	>0 <SPILL PPM
3038	LEAK LEVEL ZONE 13	UNSIGNED INT	>0 <SPILL PPM
3039	LEAK LEVEL ZONE 14	UNSIGNED INT	>0 <SPILL PPM
3030	LEAK LEVEL ZONE 15	UNSIGNED INT	>0 <SPILL PPM
3031	LEAK LEVEL ZONE 16	UNSIGNED INT	>0 <SPILL PPM
3032	SPILL LEVEL ZONE 1	UNSIGNED INT	>LEAK <EVAC PPM
3033	SPILL LEVEL ZONE 2	UNSIGNED INT	>LEAK <EVAC PPM
3034	SPILL LEVEL ZONE 3	UNSIGNED INT	>LEAK <EVAC PPM
3035	SPILL LEVEL ZONE 4	UNSIGNED INT	>LEAK <EVAC PPM
3036	SPILL LEVEL ZONE 5	UNSIGNED INT	>LEAK <EVAC PPM
3037	SPILL LEVEL ZONE 6	UNSIGNED INT	>LEAK <EVAC PPM
3038	SPILL LEVEL ZONE 7	UNSIGNED INT	>LEAK <EVAC PPM
3039	SPILL LEVEL ZONE 8	UNSIGNED INT	>LEAK <EVAC PPM
3040	SPILL LEVEL ZONE 9	UNSIGNED INT	>LEAK <EVAC PPM
3041	SPILL LEVEL ZONE 10	UNSIGNED INT	>LEAK <EVAC PPM
3042	SPILL LEVEL ZONE 11	UNSIGNED INT	>LEAK <EVAC PPM
3043	SPILL LEVEL ZONE 12	UNSIGNED INT	>LEAK <EVAC PPM
3044	SPILL LEVEL ZONE 13	UNSIGNED INT	>LEAK <EVAC PPM
3045	SPILL LEVEL ZONE 14	UNSIGNED INT	>LEAK <EVAC PPM
3046	SPILL LEVEL ZONE 15	UNSIGNED INT	>LEAK <EVAC PPM
3047	SPILL LEVEL ZONE 16	UNSIGNED INT	>LEAK <EVAC PPM
3048	EVAC LEVEL ZONE 1	UNSIGNED INT	>SPILL -10K PPM
3049	EVAC LEVEL ZONE 2	UNSIGNED INT	>SPILL -10K PPM
3050	EVAC LEVEL ZONE 3	UNSIGNED INT	>SPILL -10K PPM
3051	EVAC LEVEL ZONE 4	UNSIGNED INT	>SPILL -10K PPM
3052	EVAC LEVEL ZONE 5	UNSIGNED INT	>SPILL -10K PPM
3053	EVAC LEVEL ZONE 6	UNSIGNED INT	>SPILL -10K PPM
3054	EVAC LEVEL ZONE 7	UNSIGNED INT	>SPILL -10K PPM

Register Address	Description	Type	Range
3055	EVAC LEVEL ZONE 8	UNSIGNED INT	>SPILL -10K PPM
3056	EVAC LEVEL ZONE 9	UNSIGNED INT	>SPILL -10K PPM
3057	EVAC LEVEL ZONE 10	UNSIGNED INT	>SPILL -10K PPM
3058	EVAC LEVEL ZONE 11	UNSIGNED INT	>SPILL -10K PPM
3059	EVAC LEVEL ZONE 12	UNSIGNED INT	>SPILL -10K PPM
3060	EVAC LEVEL ZONE 13	UNSIGNED INT	>SPILL -10K PPM
3061	EVAC LEVEL ZONE 14	UNSIGNED INT	>SPILL -10K PPM
3062	EVAC LEVEL ZONE 15	UNSIGNED INT	>SPILL -10K PPM
3063	EVAC LEVEL ZONE 16	UNSIGNED INT	>SPILL -10K PPM
3064	DISTANCE ZONE 1	UNSIGNED INT	0-1200ft
3065	DISTANCE ZONE 2	UNSIGNED INT	0-1200ft
3066	DISTANCE ZONE 3	UNSIGNED INT	0-1200ft
3067	DISTANCE ZONE 4	UNSIGNED INT	0-1200ft
3068	DISTANCE ZONE 5	UNSIGNED INT	0-1200ft
3069	DISTANCE ZONE 6	UNSIGNED INT	0-1200ft
3070	DISTANCE ZONE 7	UNSIGNED INT	0-1200ft
3071	DISTANCE ZONE 8	UNSIGNED INT	0-1200ft
3072	DISTANCE ZONE 9	UNSIGNED INT	0-1200ft
3073	DISTANCE ZONE 10	UNSIGNED INT	0-1200ft
3074	DISTANCE ZONE 11	UNSIGNED INT	0-1200ft
3075	DISTANCE ZONE 12	UNSIGNED INT	0-1200ft
3076	DISTANCE ZONE 13	UNSIGNED INT	0-1200ft
3077	DISTANCE ZONE 14	UNSIGNED INT	0-1200ft
3078	DISTANCE ZONE 15	UNSIGNED INT	0-1200ft
3079	DISTANCE ZONE 16	UNSIGNED INT	0-1200ft
3080	ALARM ACK ZONE 1	UNSIGNED INT	1=ACK 0=NACK
3081	ALARM ACK ZONE 2	UNSIGNED INT	1=ACK 0=NACK
3082	ALARM ACK ZONE 3	UNSIGNED INT	1=ACK 0=NACK
3083	ALARM ACK ZONE 4	UNSIGNED INT	1=ACK 0=NACK
3084	ALARM ACK ZONE 5	UNSIGNED INT	1=ACK 0=NACK
3085	ALARM ACK ZONE 6	UNSIGNED INT	1=ACK 0=NACK
3086	ALARM ACK ZONE 7	UNSIGNED INT	1=ACK 0=NACK
3087	ALARM ACK ZONE 8	UNSIGNED INT	1=ACK 0=NACK
3088	ALARM ACK ZONE 9	UNSIGNED INT	1=ACK 0=NACK
3089	ALARM ACK ZONE 10	UNSIGNED INT	1=ACK 0=NACK
3090	ALARM ACK ZONE 11	UNSIGNED INT	1=ACK 0=NACK
3091	ALARM ACK ZONE 12	UNSIGNED INT	1=ACK 0=NACK
3092	ALARM ACK ZONE 13	UNSIGNED INT	1=ACK 0=NACK
3093	ALARM ACK ZONE 14	UNSIGNED INT	1=ACK 0=NACK

Register Address	Description	Type	Range
3094	ALARM ACK ZONE 15	UNSIGNED INT	1=ACK 0=NACK
3095	ALARM ACK ZONE 16	UNSIGNED INT	1=ACK 0=NACK
3096	ALL ALARM ACK	UNSIGNED INT	1=ACK 0=NACK

B.5. Block Mode Register Summary

B.5.1. Summary of Registers

Register Name Number	HEX	Decimal	Description
System Data	0x0010	16	R/W System Setup Data
Status	0x0011	17	R/W Operating summary of faults, alarms and status
Zone Data	0x12xx	4609-4630	R/W Setup data for up to 16 zones (xx defines zone number)
CAL Data	0x0014	20	R/W Cal Factors for all gases
Date/Time	0x0015	21	R/W Set MZ date & time
Sensor Data	0x0016	22	R Raw measurement of sensors
Rel. Hold	0x0017	23	W Release MZ out of hold mode
Hold Zone	0x0018	24	W Put MZ into hold mode
Fault Log	0x19xx	6400-6401	R 20 most recent fault events (xx = 00 or 01)
Flow Log	0x001F	31	R 20 most recent flow fault events
Alarm Log	0x1Axx	6656-6658	R 20 most recent alarm events (xx = 00, 01, or 02)
Serv. Mode	0x001B	27	W Puts MZ into service mode
Rel Serv.	0x001C	28	W Release MZ from service mode
PPM	0x001E	30	R PPM values for all zones
Zone Log	0x3yxx	0-6	Trend data for each MZ zone [y = zone # (starting at 0), xx = 00 – 06] Data

Data Type Abbreviations	
C	Character
Float	Floating Point
I	Integer
TIM	Time
UI	Unsigned Integer

B.5.2. System Data Register 0x0010 (16 Dec) (R/W, 54 Bytes)

Variable	Type	Length	Description
Type	UI	2 bytes	Indicates EEPROM has been initialized if value = 300 DO NOT MODIFY
REV	Float	4 bytes	Firmware Rev Level DO NOT MODIFY
UNUSED	UI	2 bytes	Firmware Serial Number DO NOT MODIFY
Node	UC	1 byte	Network Slave Node # (valid values are 1-15). The default is that indicated by the Node DIP Switch on main board.
Location	C	13 bytes	Array defining text name of unit
Stop_Bits	C	1 byte	Number of stop bits used in the MZ data stream. Default = 1. Other available value is 2

Variable	Type	Length	Description
Aud_Alarm	UC	1 byte	Sounds internal board buzzer on condition; 0 = no buzzer; 1= Alarm; 2=Fault; 3=Leak; 4=Spill; 5=Evacuate; 6=Monitor Off line (DEFAULT = 0)
Alarm_Ack_Mode	UC	1 byte	Defines Alarm Operation. Manual Acknowledge = 0; Auto Acknowledge = 1 (DEFAULT = 0)
Num_Zones	UC	1 byte	Number of install zones (Value initialized during auto detect during Power On Self Test).
UNUSED	TIM	13 bytes	UNUSED
Rezero_Mode	UC	1 byte	Defines re-zero mode. Auto Re-zero = 0; Re-zero every zone = 1 (DEFAULT = 0)
Hold_Time	UI	2 byte	Length of zone hold interval in minutes (DEFAULT = 15 minutes)
UNUSED	UC	1 byte	Minimum detection limit (in PPM). Concentrations less than or equal this value will read as 0 PPM (DEFAULT = 0 PPM)
Avg_Size	UC	1 byte	Size of running average used in computing PPM value. DO NOT MODIFY.
Loop2_factor	Float	4 bytes	Defines PPM current loop output. (DEFAULT = 0.16 mA/PPM)
Serv_Mode_TO	UI	2 bytes	Service Mode Timeout value (in minutes). (DEFAULT = 60 MINUTES)
RS485_BAUD	UI	2 bytes	BAUD RATE for RS-485 connection (between RD and MZ monitor or MODBUS master and MZ depending on the Network topology). Default=9 (19.2K); other values are 8=9600, 7=4800
Mode	UI	2 bytes	UNUSED

B.5.3. Status Register 0x011 (17 Dec) (R/W, 10 Bytes)

Variable	Type	Length	Description
Mode	UC	1 byte	Defines Operating Mode of MZ. 0 = normal Mode; 1 = Zone_Hold Mode; 2 = Diagnostic Mode; 3 = Service mode. DO NOT MODIFY (use zone hold register or service mode register to change this parameter)
State	UC	1 byte	Defines MZ Current State. 0 = Idle; 1 = Sampling; 2 = Zeroing; 3 = Warm Up, 4 = Pressure Check DO NOT MODIFY
Measuring	UC	1 byte	Value = 1 if unit is acquiring detector signal for running avg. DO NOT MODIFY
Active_Zone	UC	1 byte	Current Zone being checked. 0=zone 1, 1=zone 2, etc.
Max_Alarm	UC	1 byte	Indicates highest non-acknowledged alarm level DO NOT MODIFY
Alarm_Count	UC	1 byte	Number of alarms that are currently active. DO NOT MODIFY
UNUSED	UC	1 byte	UNUSED
Loop_Card	UC	1 byte	Value = 1 if 4-20 mA card has been detected. DO NOT MODIFY
Fault	UI	2 bytes	Fault Flag Structure uses bitwise access to 16 bit word as defined in the table below.

B.5.4. Fault Code Table

BIT	Fault Type	Code	Description
15	CLIPPING FAULT	0x8000	0x8000 Sensor output voltage too high
14	ZERO RANGE FAULT	0x4000	Sensor output voltage outside limits during purge
13	OVER RANGE FAULT	0x2000	Gas concentration above measurable range
12	PURGE FLOW FAULT	0x1000	No flow detected during purge cycle
11	ZONE FLOW FAULT	0x0800	No flow detected during sample cycle
10	A2D FAULT	0x0400	Analog to digital converter not working
9	GAIN SET FAULT	0x0200	Digipot gain setting out of normal range
8	ZERO FILTER FAULT	0x0100	Charcoal filter (if used) needs replacement
7	CONFIG FAULT	0x0080	No zones are enabled
6	UNUSED FAULT 2	0x0040	
5	UNUSED FAULT 1	0x0020	
4	LOOP FAULT	0x0010	Current loop is open
3	RS485 FAULT	0x0008	Communications error
2	MANIFOLD P FAULT	0x0004	Pressure sensor readings are out of range
1	BENCH T FAULT	0x0002	Sensor temperature is out of range
0	BOX T FAULT	0x0001	Chassis temperature is out of range

B.5.5. Zone Data Register 0x12xx (R/W, 78 Bytes)

Each zone for an MZ has a separate zone data structure that is 78 bytes long. The zone number is the low order byte in the register address (i.e., Zone 1 data register = 0x1201h).

Variable	Type	Length	Description
Location	C	13 bytes	13 byte array, Alpha Numeric Description or Name of Zone
Flow OK	UC	1 byte	Status of Flow check. Value of 1 indicates flow check is good. DO NOT MODIFY.
Refrigerant Type	UC	1 byte	See note 1 Below (DEFAULT = R134a)
Distance	UI	2 bytes	Zone Tubing Length (in feet) (DEFAULT = 100 feet [approx. 30.5 meters])
Zone Temp	I	2 bytes	Average temperature at zone (degrees C) (DEFAULT = 25°C)
Concentration	Float	4 bytes	Last Measured concentrations (uM/L) DO NOT MODIFY
Concentration2	Float	4 bytes	Last Measured concentration (PPM) DO NOT MODIFY
Alarm Ack	UC	1 bytes	Set value to 1 to acknowledge Alarm. <div style="border: 1px solid black; padding: 5px; display: inline-block;">  <p>NOTE: MZ will reset this byte to 0 when the Alarm byte (below) is = 0 and zone in alarm is sampled. If the alarm condition/byte increases (leak>>spill or spill>>evac) the MZ will also reset this byte to 0.</p> </div>
Alarm	UC	1 bytes	Alarm Status; 0 = no alarm, 1 = leak; 2 = spill; 3 = evac.
Leak Level	UI	2 bytes	Level to trigger a leak alarm (in PPM) (DEFAULT = 100)
Spill Level	UI	2 bytes	Level to trigger a spill alarm (in PPM) (DEFAULT = 300)
Evac Level	UI	2 bytes	Level to trigger a evacuate alarm (in PPM) (DEFAULT = 500)
Peak PPM	UI	2 bytes	Highest Recorded PPM in zone
Peak Time	TIM	13 bytes	Date an time of highest peak (see note 2 for format)
Alarm Time	TIM	13 bytes	Date and time of last alarm (see note 2 for format)
Alarm Ack/Time		13 bytes	
Log Interval	UI	2 bytes	Number of minutes between Log entries (DEFAULT = 1440)



NOTE: Refer to the *Recommended Alarm Settings & Gas Enumeration* table on page 53.



NOTE: Time Structure Format consists of 13 unsigned character types. They are 1 second digit, 10 second digit, 1 minute digit, 10 minute digit, 1 hour digit, 10 hour digit, 1 day digit, 10 day digit, 1 month digit, 10 month digit, 1 year digit, 10 year digit, last byte is unused.

B.5.6. Alarms and Alarm Acknowledge

The Multi-Zone can be operated in two different alarm acknowledge modes, Auto and Manual (set via the `alarm_ack_mode` variable in the system data register). For purposes of this discussion, the term “Alarm” refers to an MZ state where the alarm light is on and the appropriate alarm relay is activated. The term “Alarm condition” refers to the external condition (i.e., refrigerant leak) that initially causes the MZ monitor to go into an alarm. If an alarm occurs it can be handled in one of 3 ways.

- 1. Non-Latching Mode.** This mode is enabled by setting the `AUTO_ACK_MODE` parameter in the system register to “1”. In this mode, if an alarm condition occurs an MZ alarm will be created. If the alarm condition is subsequently removed, the MZ alarm will automatically be cleared by the MZ monitor when the zone in alarm is sampled “clear”. Note, in this mode of operation, it is possible for an alarm to occur and be cleared without user or MODBUS master intervention. If this is the case, the only evidence of the alarm would be contained in the MZ alarm log.
- 2. Latching Mode with Silence.** This mode is enabled by setting the `AUTO_ACK_MODE` in the system register to “0”. In this mode, if an alarm condition occurs, an MZ alarm will be created. In order for the alarm to be removed the MODBUS master will write a “0” to the `ALARM` parameter in the `ZONE` register. This will cause the alarm to be “silenced” in the MZ monitor (i.e., the alarm relays will return to their normal state and the `ALARM` lamp will be extinguished). The next time the zone with the alarm condition is sampled, if the alarm condition still exists, the alarm will be reactivated and the alarm parameter will be reset to “1” in the MZ. Otherwise, if the alarm condition has cleared, no further action is required and normal operation will resume.
- 3. Latching Mode without Silence.** This mode is enabled by setting the `AUTO_ACK_MODE` in the system register to “0”. In this mode, if an alarm condition occurs, an MZ alarm will be created. The MZ MODBUS master will then write a “1” to the `ALARM ACK` parameter in the zone register. The alarm will continue to persist (i.e., Relays in alarm state and Alarm light on) until the offending zone is sampled and no alarm condition is detected. At that point, the `ALARM ACK` parameter is automatically cleared by the MZ monitor, as is the `ALARM` parameter.



NOTE: If the `ALARM ACK` parameter is set to “1” and the `ALARM CONDITION` is upgraded (from leak to spill, or spill to evacuate) the `ALARM ACK` parameter will automatically be cleared to “0” by the MZ.

B.5.7. Date Time Register 0x0015 (21 Dec) (R/W, 14 Bytes)

Variable	Type	Length	Description
Date_Time	Time	14 bytes	Contains current time and date. Structure is defined as in note 2 of zone data

Time Structure Format consists of 14 unsigned character types. They are 1 second digit, 10 second digit, 1 minute digit, 10 minute digit, 1 hour digit, 10 hour digit, a day digit, 10 day digit, 1 month digit, 10 month digit, 1 year digit, 10 year digit, day of the week, last byte is unused.

B.5.8. Sensor Data Register 0x0016h (22 Dec) (R, 82 Bytes)

Variable	Type	Length	Description
Pressure	Float	4	Manifold Pressure is PSIA
P_Volts	Float	4	Pressure sensor output Voltage
Vacuum_P	Float	4	Pressure with all value closed and pump on in PSIA
Ambient_P	Float	4	Absolute Ambient Pressure in PSIA
Box_T	Float	4	Enclosure Temperature in Degrees C
Box_T_Volts	Float	4	Box temp sensor output voltage
Bench_T	Float	4	Optical bench temperature in Degrees C
Bench_T_Volts	Float	4	Bench temp sensor output voltage
Bench_Z_T	Float	4	Optical bench temp in degrees C at last zero interval
Box_Z_T	Float	4	Box temp in degrees C at last zeroing
PkPk_int	UI	2	Current peak to peak A/D counts from detector
PkPk	Float	4	Current peak to peak voltage from detector
Ave_PkPk	Float	4	Running average voltage from detector
Zero_PkPk	Float	4	Voltage measured at last zeroing
Noise	Float	4	Largest Change in running average
AU	Float	4	Current absorbance value
Ave_AU	Float	4	Running Average of absorbance level
Bench_PPM	Float	4	PPM in bench based on zone gas selection (uncorrected for pressure and temperature)
STP_PPM	Float	4	PPM corrected to STP (1 atm, 25 deg C)
Bench_UML	Float	4	Micromoles/liter in bench (uncorrected)
Ambient_UML	Float	4	Micromoles/liter corrected to ambient pressure

B.5.9. Release Zone Hold Register 0x0017h (23 Dec) (W, 10 Bytes)

Variable	Type	Length	Description
Rel_Hold	*	*	See description of STATUS REGISTER

B.5.10. Hold Zone Register 0x0018h (23 Dec) (W, 10 Bytes)

Variable	Type	Length	Description
Zone_Hold	*	*	See description of STATUS REGISTER

B.5.11. MZ Hold Mode

The MZ monitor can be made to hold or “dwell” on a particular zone if necessary. The length of the hold time is defined by the HOLD TIME parameter in the System Data Register.

Placing the MZ Monitor into hold mode:

1. Read the MZ Status Register (0x0011h)
2. Modify the content of the status register structure to change the MODE parameter to zone hold mode. Active zone parameter to the zone you wish to hold
3. Send this updated status register structure back to the MZ using PRESET MULTIPLE REGISTER COMMAND to the HOLD ZONE REGISTER (0x0018h).

Releasing the Zone Hold

1. Read the MZ monitor Status Register (0x0011h)
2. Modify the content of the status register to change the MODE parameter to normal mode. Active zone parameter to the zone which you would like to resume normal activity on
3. Send this updated status register structure back to the MZ using PRESET MULTIPLE REGISTER COMMAND to the RELEASE HOLD REGISTER (0x0017h).

B.5.12. Fault Log Register 0x1900-01 (6400-6401 Dec) (R, 302 Bytes)

These registers contain the 20 most recent fault events, the time they occurred, and a pointer to the most recent event. The data is split into 2 registers. The first register contains 200 bytes and the second register contains 102 bytes. The results of these two register reads should be recombined into the Fault Log Data Structure after both have been received.

Variable	Type	Length	Description
Fault	UI	40 bytes	20 most recent fault events. Each event is decoded as indicated in Fault Flag Structure given after the Status Register Description
Time	TIM	260 bytes	Time of each fault occurrence. TIM value as defined in NOTE 2 of Zone Data
Ptr	UC	1 byte	Pointer to most recent event
Unused	UC	1 byte	Unused

B.5.13. Flow Log Register 0x001F (31 Dec) (R, 142 Bytes)

Variable	Type	Length	Description
Flow Event	UI	40 bytes	20 most recent flow fault events. Each bit of the unsigned int represents a zone and a 1 indicates no flow. Zero indicates flow.
Purge Flow Event	UC	20 bytes	20 most recent flow fault events where a 1 indicates no flow. Zero indicates flow.
Time	TIM	80 bytes	Time/date stamps for 20 most recent logged flow events. This variable is an unsigned long integer formatted as seconds since Jan 1 of 1980
Ptr	UC	1 byte	Pointer to most recent event
Unused	UC	1 byte	Unused

B.5.14. Alarm Log Register 0x1A00-02 (6656-58 Dec) (R, 582 Bytes)

These registers contain the 20 most recent alarm events, the time they occurred, and a pointer to the most recent event. The data is split into 3 registers and should be recombined into an appropriate structure after all three registers have been received. Register 0x1A00h contain 200 bytes, Register 0x1A01h contains 200 bytes, and register 0x1A02h contains 181 bytes.

Variable	Type	Length	Description
Event	UC	320 bytes	20 most recent alarm events. Each event contains 1 byte for each zone. Each zone Byte is defined as 0=No Alarm, 1=Leak Alarm, 2=Spill Alarm, 3=Evac Alarm.
Time	TIM	260 bytes	Time of each alarm event. TIM value as defined in NOTE 2 of Zone Data
Ptr	UC	1 byte	Pointer to most recent event
Unused	UC	1 byte	Unused

B.5.15. Service Mode Register 0x001B (27 Dec) (W, 10 Bytes)

Variable	Type	Length	Description
Rel_Svc_Mode	*	*	See description of STATUS REGISTER

B.5.16. Release Service Mode 0x001C (28 Dec) (W, 10 Bytes)

Variable	Type	Length	Description
Ent_Svc_Mode	*	*	See description of STATUS REGISTER

B.5.17. MZ Service Mode

The MZ monitor can be placed into service mode if necessary. During service mode the unit will take no measurements, any and all alarms are silenced, and all relays are opened. The unit automatically comes out of service mode after a preset interval defined by the service_mode_TO parameter in the System Data Register.

Placing the unit into Service Mode:

1. Read the MZ Status Register (0x0011h)
2. Modify the content of the status register structure to change the MODE parameter to service mode.
3. Send this updated status register structure back to the MZ unit using PRESET MULTIPLE REGISTER COMMAND to the SERVICE MODE REGISTER (0x001Bh).

Releasing the unit from Service Mode:

1. Read the MZ Status Register (0x0011h)
2. Modify the content of the status register to change the MODE parameter to normal mode.
3. Send this updated status register structure back to the MZ unit using PRESET MULTIPLE REGISTER COMMAND to the RELEASE SERVICE MODE REGISTER (0x001Ch).

B.5.18. PPM Register 0x001E (30 Dec) (R, 32 Bytes)

Variable	Type	Length	Description
PPM	UI	32 bytes	16 Unsigned Integers that represent the PPM values for each MZ monitor zone



NOTE: 16 values are returned independent of the number of actual zones installed in the unit. The master device is required to know how many zones are installed in the unit (available in the System Register) in order to properly interpret the data.

B.5.19. Zone Log Registers 0x3xyy (R, 1502 Bytes)

These registers are used to transfer the zone log data. Each zone has a circular log of 100 past data points. The period between data points is defined by the Log Interval parameter in each corresponding Zone Data Register. The data for each zone is defined by the “x” place in the above register address. For zone 1 the Register address is 0x30yyh, for zone 2 the register address is 0x31yyh, etc. The data for each zone is sent in 8 consecutive registers due to MODBUS RTU message length constrains. The addresses are defined by the “yy” place in the above address. For zone 1, all log data can be obtained by reading 0x3000h, 0x3001h, 0x3002h, , 0x3007h. The first seven registers contain 200 bytes each and the last register contains 102 bytes. After all registers have been received the data should be reassembled into the full data structure.

Variable	Type	Length	Description
Index	UI	2	Point to current reading
Time	TIM	1300	Time record for each of the 100 log points. The format for the TIM type is defined in note 2 of zone data
PPM	UI	200	Last 100 log points (2 bytes per point)

APPENDIX C. SYSTEM MENU MAP

Multizone System Map Sample Setup Screens

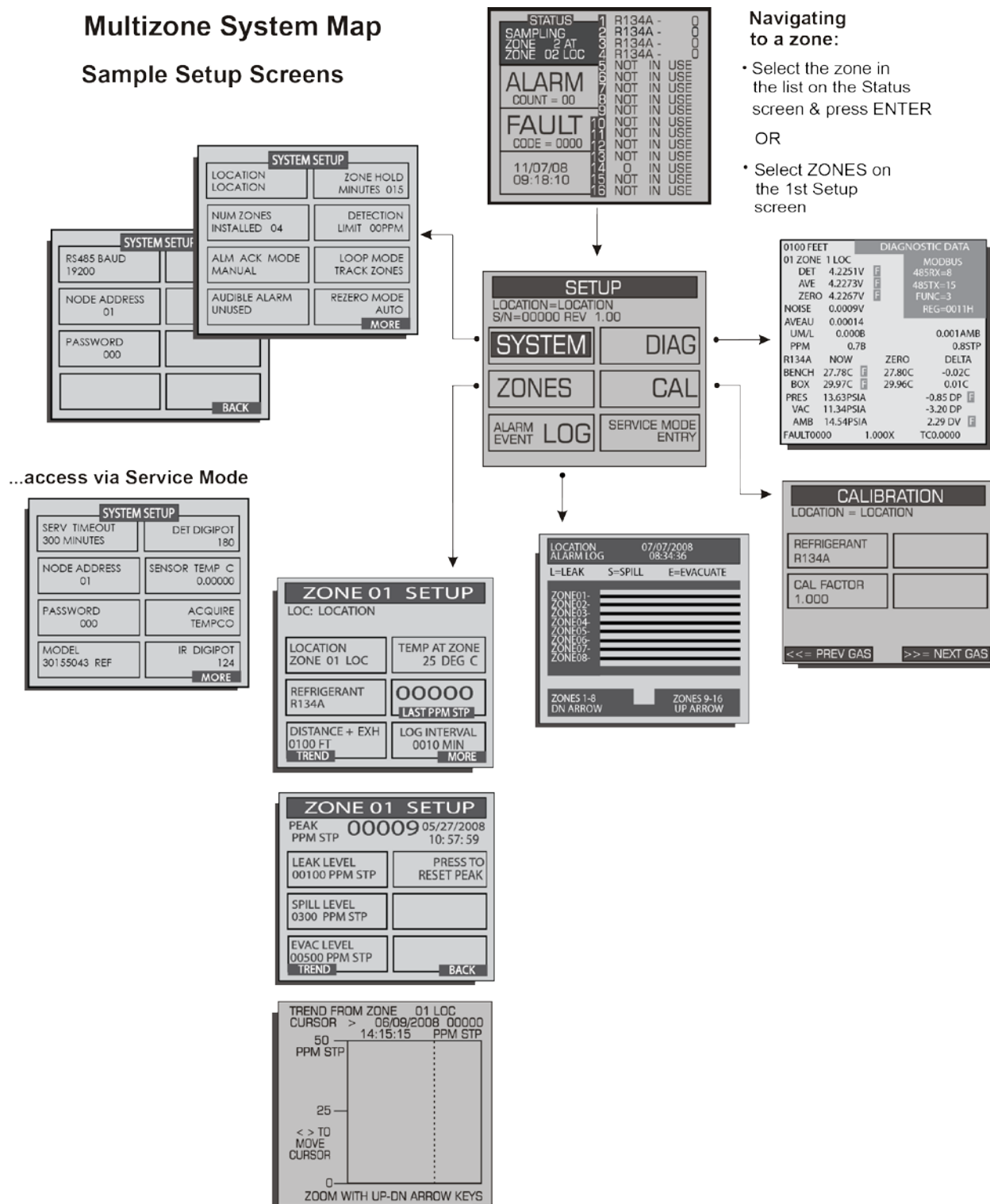

MultiZone System Map Sample Alarm & Fault Screens

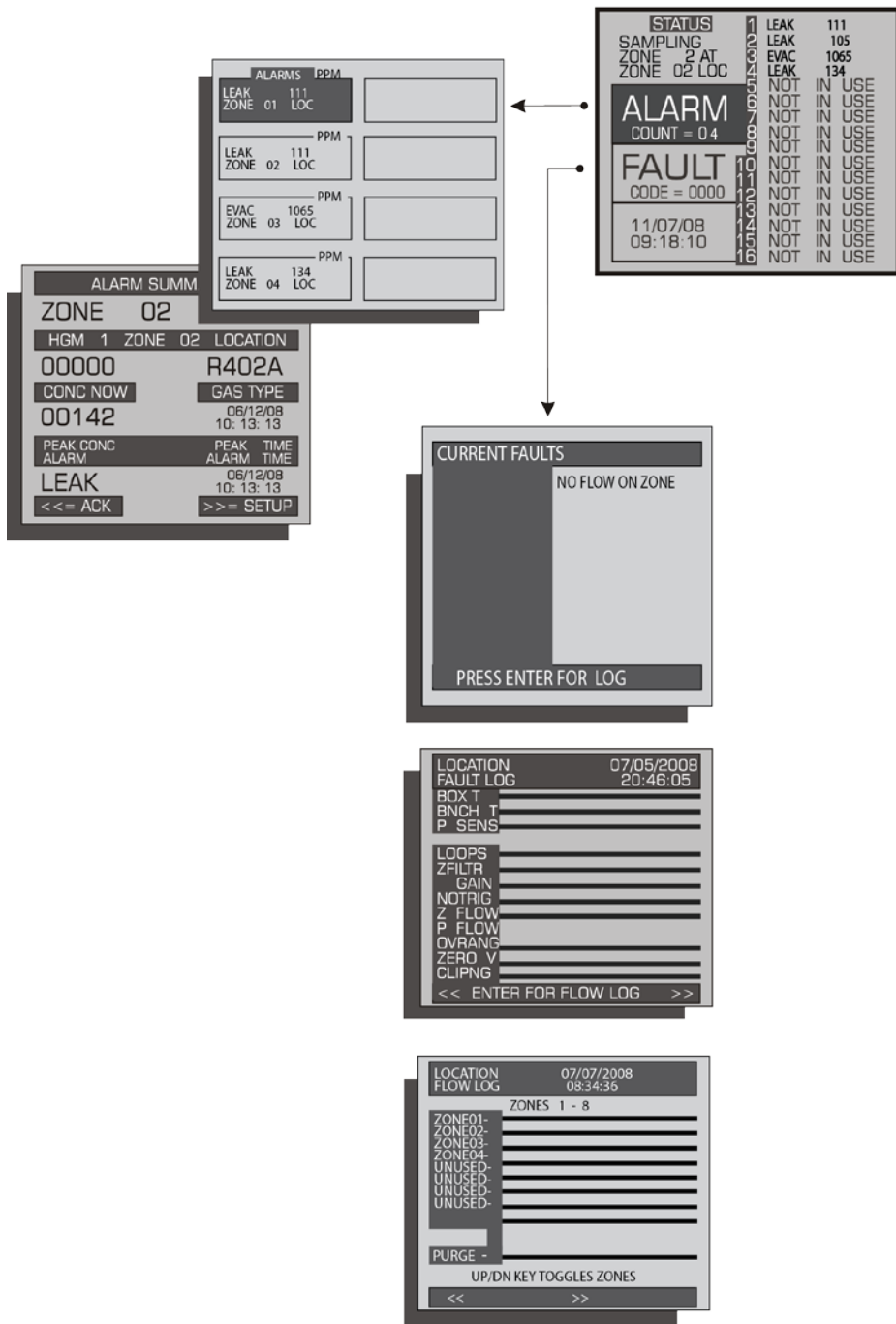

Navigating to a zone:

- Select the zone in the list on the Status screen & press ENTER
- OR
- Select ZONES on the 1st Setup screen

APPENDIX D. AGENCY APPROVALS



CE Declaration of Conformity

The Manufacturer of the Products covered by this Declaration

BACHARACH Inc
621 Hunt Valley Circle
New Kensington, Pa 15068

Year in which conformity is declared: 2008

Products: Refrigerant Monitors

Model: HGM-SZ, AGM-SZ, CO2-SZ, HGM-MZ, AGM-MZ, CO2-MZ and MZ-RD

The undersigned hereby declares that the above referenced products are in conformity with the provisions of the following Directives and Standards.

Standards:

EN 61326-1:2006 – Electrical Equipment for measurement, control and Laboratory use – EMC Requirements – Part 1 General requirements
EN 61010-1:2001 – Safety Requirement for Control, Measurement & Laboratory Equipment

Directives:

In accordance with EMC Directive (2004/108/EC)
In accordance with Low Voltage Directive (2006 / 95 EC)

Signature:

Name: Doug Keepors
Title: VP of Product Development
Date: 23 August 2010

The technical documentation file required by this directive is maintained at the corporate headquarters of Bacharach Inc

MET LABORATORIES, INC. CERTIFICATION RECORD



The applicant named below has been authorized by MET Laboratories, Inc. to represent the product(s) listed in this record as "MET Certified" and to mark this/these product(s) according to the terms and conditions of the MET Mark Utilization Agreement, MET Listing Reports, and the applicable marking agreements. Only the product(s) bearing the MET Mark and under a follow-up service are considered to be included in the MET Certification program. This certification has been granted under a System 3 program as defined in ISO Guide 67.

FILE NUMBER: E113096

APPROVAL DATE: November 30, 2010

REVISED: -

PRODUCT(S)	MODEL(S)	ELECTRICAL RATINGS
Refrigerant Monitors and Remote Display Monitors	HGMSZ, AGMSZ, CO2SZ, HGM-MZ, Emerson, RLM, CIR, AGM-MZ, CO2-MZ, MZ-RD	Models HGMSZ, AGMSZ, and CO2SZ: 100-240Vac, 15 Watts, 50/60Hz
		Models HGM-MZ, Emerson, RLM, CIR, AGM-MZ, CO2-MZ: 100-240Vac, 20 Watts, 50/60Hz
		Model MZ-RD: 100-240Vac, 20 Watts, 50/60 Hz

STANDARD NUMBER	STANDARD TITLE	EDITION
UL61010-1/CSA C22.2 No. 61010-1	Standard for Safety for Electrical Equipment for Measurement, Control and Laboratory Use: Part 1: General Requirements	Second

MET LABORATORIES, INC. requires that any and all changes proposed in the previously identified product(s), that affects the information contained in the above referenced listing report, must be submitted to MET for evaluation prior to implementation to assure continued MET Certification status.

The above identified product(s) has/have been submitted by the applicant:

APPLICANT:

Bacharach, Inc.
621 Hunt Valley Circle
New Kensington, PA 15068

The covered products shall be subjected to follow-up inspections to ensure that the Certified product(s) are identical to the representative product sample evaluated by MET LABORATORIES, INC. and that all manufacturer's responsibilities are being fulfilled as specified in the MANUFACTURING RESPONSIBILITY section of the Certification report.

Rick Cooper
Director of Laboratory Operations,
Safety Laboratory



*MET Laboratories, Inc. is accredited by OSHA and the Standards Council of Canada.
The Nation's First Nationally Recognized Testing Laboratory*





Declaration of Conformity

The Manufacturer of the Products covered by this Declaration is

BACHARACH Inc
621 Hunt Valley Circle
New Kensington, Pa 15068

The European Standard covered by this Declaration

EN 14624 "Performance of mobile leak detectors and of room controllers of halogenated refrigerants"

The Products Covered by this Declaration

HGM-SZ and HGM-MZ, Single and Multi Zone Refrigerant Monitors

The Basis on which Conformity is being Declared

The manufacturer hereby declares under his sole responsibility that the products identified above comply with the approval standard EN 14624 Performance of mobile leak detectors and room controllers of halogenated refrigerants. The technical documentation required to demonstrate that the products meet the requirements of EN 14624 has been compiled and is available for inspection by the relevant enforcement authorities. October, 2010

Signature:

Name: Doug Keenforts

Title: VP of Product Development

Date: 06 December 2010

The technical documentation file required by this directive is maintained at the corporate headquarters of Bacharach Inc

European Standard EN14624: 2005 testing with R-134a (Halogen Gas Monitor Only).

Min. Sensitivity Threshold	1 ppm
Max. Sensitivity Threshold (within 1 ppm \pm 10% reading accuracy range)	1,000 ppm
Max. Sensitivity Threshold within Instrument Reading Range	10,000 ppm
Zeroing Time from 1,000 ppm*	<12 seconds
Zeroing Time from 10,000 ppm*	<25 seconds
Reaction Time for detection of minimum threshold*	\leq 12 seconds
Min. Sensitivity threshold once max. threshold has been measured	1 ppm
Repeatability at 500 ppm	\pm 1% of reading

* Based on a minimum tubing length of one foot

APPENDIX E. SERVICE CENTERS

United States

Bacharach, Inc.
621 Hunt Valley Circle
New Kensington, PA 15068
Phone 724-334-5051
Fax: 724-334-5723
Email: help@MyBacharach.com

Canada

Bacharach of Canada, Inc.
20 Amber Street Unit #7
Markham, Ontario L3R 5P4
Canada
Phone: 905-470-8985
Fax: 905-470-8963
Email: support@BachCan.ca

Europe

Murco Limited – a Bacharach Company
114a Georges Street Lower
Dun Laoghaire
Co. Dublin
Ireland
Phone: 353 1 284 6388
Fax: 353 1 284 6389
Email: sales@murco.ie

INDEX

NUMBERS	
0007-1650	47, 48
0007-1655	12, 47, 54
0007-1656	12, 54
0007-1657	12, 54
0204-0020	48
0304-3235	47
0304-5111	48
04-2620	47
204-0020	48
3015-2906	47, 48
3015-2969	4, 48
3015-3076	49
3015-3125	4, 11, 47, 48
3015-3235	11, 48
3015-3411	12, 48, 49
3015-3420	4, 11, 12, 47, 48
3015-3430	49
3015-3437	49
3015-3438	49
3015-3849	49
3015-3850	49
3015-3851	49
3015-3852	49
3015-4121	49
3015-4123	49
3015-4492	48
3015-4562	48
3015-4572	48
3015-4992	49
3015-5072	49
3015-5073	49
3015-5074	i, 4
3015-5080	49
3015-5081	49
3015-5109	10
3015-5152	21, 48, 49
3015-5171	12, 48, 49
3015-5176	48
3015-5389	48
3015-5390	48
3015-5404	12, 49
3015-5405	12, 49
3015-5483	48
3015-5490	49
3015-5491	49
3015-5492	49
3015-5493	49
3015-5512	4, 12, 47, 48
3015-5521	48
3015-5522	49
3015-5523	48
3015-5524	49
3015-5525	49
3015-5526	49
3015-5527	49
3015-5528	49
3015-5530	49
3015-5542	49
4-20 mA DC outputs/loops	13, 38
Interface Board	21, 48
A	
A2D fault	37, 59
absorbance	44
AC input power	2, 8, 13, 14, 23, 24, 38, 47, 48
disconnecting	9
removing prior to service	2
source	2, 13
terminals	13, 23
accessories	4, 12, 48-54
accuracy	7
acknowledging alarms	6, 33, 34, 35, 62
active diagnostics	5
address	17, 28, 30, 45, 61, 59, 67
air lines	11, 31, 48
tubing	47
air pump	13
alarm(s) 4-6, 8, 19, 20, 23, 24, 26, 29, 33-35, 38, 47, 49, 59-64, 66, 67	
acknowledgement mode	26, 35
audible	4, 26, 33, 35, 36
condition	26, 33, 35, 36, 44, 63, 64
detail screen	34, 35
event log	36
LED	4, 33
levels	5
log	20
manually acknowledged	26
nuisance	5
set points	5
settings	57, 64
summary screen	34, 35
time	34
unacknowledged	34
uncleared	34
alphanumeric characters	26, 29, 30, 31
altitude limit	3
ambient air, CO ₂ presence	11, 42
ambient pressure	44
annual maintenance kits	49
ANSI/BSR ASHRAE 15-2007	5, 7
ASHRAE Safety Code 34-2007	5, 7
audible alarm	4, 26, 33, 35, 36

B

Bacharach
 service center3, 9
 website.....16
 battery48
 replacement schedule48
 shelf life.....48
 baud rate28
 Belden cable #876217
 bench.....38, 45, 65
 temp fault.....38
 blockage37
 box temp fault.....38
 building management system5, 8, 15, 17, 18,
 21, 59
 bypassing a zone19

C

cable shield22
 cable ties13
 CAL factor40-44
 calibration18, 20, 41, 42, 45
 factor.....40-44
 factory, voiding41
 procedure.....41
 screen40-43
 cautions and warnings1
 CE Mark8
 cfg file extension20
 charcoal filter4, 11, 37, 47-49
 chassis temperature.....44
 circuit board.....15, 22, 23
 circuit breaker.....2, 14
 clean air10
 cleaning3
 clearing purge line.....19, 25
 clipping fault37, 63
 clock battery48
 COM1 and COM219
 communications parameters19
 communications protocol5
 components.....4, 13
 concentration.....44
 condensation12
 conduit.....13, 23
 config fault38, 63
 connections2, 15, 22
 exhaust line10
 purge line10
 relay23
 sample lines.....10
 contaminants.....11, 37, 47
 crimp-on ring terminals.....13
 critical faults.....37, 38
 current loop22, 38

board4
 fault.....22
 isolator.....22
 outputs.....21, 22
 cycle time32

D

damage1, 3, 6, 9, 14, 21, 47
 preventing during shipment.....13
 shipping9
 data display screen25, 29, 37
 data point40
 dateiii, 8, 34, 36, 39, 40, 48, 61, 64, 66
 DB25-to-DB9 adapter20
 detection limit27
 detector connector13
 diagnostic screen20, 38, 44, 45
 digipot29, 37
 dimensions.....8
 display screen4
 distance parameter5
 downstream port17
 drilling holes9, 14

E

EDIT menu.....19
 electrical connections and wiring9, 13, 14
 electronic components9, 47
 emissions4
 emitter30
 EN1462467
 enclosure2, 9, 10, 14, 16, 45, 47
 end-of-line filter4, 12, 47, 49
 ESC key25, 35, 40
 evacuation.....4, 47
 alarm23, 33, 57, 62, 63
 level33
 Excel file.....20
 exhaust line5, 37, 47
 connecting11
 max length.....6, 9, 11, 12
 exhaust port2, 48
 max length32
 exhaust tubing.....5
 explosive atmosphere warning2
 external alarm4, 24, 33, 36
 devices, triggering4, 23
 external monitoring devices21
 external power source23, 24

F

factory default settings38, 41
 fault(s) ..4-6, 8, 20, 23, 26, 36-39, 44, 45, 47, 54,
 59-63, 66
 log.....20, 39
 screen.....37, 39

filter(s)iii, 4, 5, 11, 12, 37, 47-54, 63
 replacement.....12
 termination.....12
 firmware version.....25
 flammable liquids2, 9
 flashing box (alarm condition)34, 44
 flow control19
 flow events39, 66
 flow log screen39
 viewing.....39
 front panel4, 5, 18, 25
 indicator4, 5, 18, 25
 keypad25
 fuse(s)3, 13, 24, 47, 48
 fuses.....

G

gain set fault.....36, 37, 63
 gas inlet.....13
 gas library.....7
 gas outlet.....13
 gas type.....44
 gas/refrigerant type31
 ground13, 14, 15, 22
 GND terminal/stud13
 ground wire13, 14

H

H1234YF6, 57, 68
 H1234ZE6, 57, 68
 Halogen Gas Monitor4, 11, 67
 HGM300 PC software18
 highest PPM concentration mode27
 hold mode.....41, 43, 61, 65
 horn24, 35
 humid installation area6
 humidity8
 hydrophobic filter13, 47

I

increase monitoring capacity.....12
 infrared zero baseline.....10
 in-line fuse.....24
 installation1, 2, 5, 9, 11-13, 21, 38
 intake placement4, 9-11, 12, 37, 47, 48
 instruction manual4
 intake connectors11
 intake line(s).....11, 12
 condensation12
 max length12
 IR bench/detector13, 29
 replacement kit48
 IR digipot30
 IR source connector13
 isolated grounds.....22

J

J5 connector13
 J6 connector13
 jumper wire22

K

knockout(s)3, 9, 13-15, 22, 23

L

laptop19, 20
 leak4-6, 19, 23, 26, 33, 42, 57, 62, 63, 64, 66
 alarm33
 level33
 LED(s).....4, 8, 35, 36, 38
 length parameter.....12
 LINE 113
 LINE 213
 line end filter.....4, 11, 12, 47
 placement.....12
 line terminations.....12
 location.....5, 11, 12, 26, 31, 34, 40, 42
 log20, 32, 36, 39, 40, 64, 67, 68
 files38
 interval.....32
 previous readings4
 loop fault38, 63
 loop mode27
 loop2 factor21, 27

M

main PC board13
 maintenance1, 2, 5, 47
 manifold(s)11-13, 26, 38, 45, 48
 pressure44
 replacement fittings49
 measurement cycle.....31, 32, 33
 measuring range7
 mechanical room.....5, 6, 9
 memory33, 36, 39, 41, 60
 menu map69, 67
 microprocessor board13
 Microsoft Excel file20
 MODBUS5, 15, 44, 59, 67
 function.....44
 model number29
 modifications3
 moisture11, 12, 47
 monitoring capacity, increasing12
 mounting
 bracket.....12
 cutouts.....4
 location9, 10
 template.....4, 10
 MZ network17, 59

N

N7100.....6, 57, 68
 N7200.....6, 57, 68
 N7300.....6, 57, 68
 N7600.....6, 57, 68
 NEC/CEC compliance.....13, 14
 network..... 16, 17, 28, 30, 31, 34, 35, 38, 59, 60
 neutral13
 no flow on purge.....37
 no flow on zone.....37
 node address17, 28, 30
 normally closed23
 normally open.....23
 nuisance alarms5
 number of installed zones26

O

optical bench temperature.....44
 optical sensor output voltages44
 output voltages44
 outputs.....13
 over range detected37

P

password..... 28-30, 60
 patent ii
 PCMCIA slot.....20
 PCMCIA-to-serial converter20
 peak concentration/PPM level33, 34
 peak time.....34
 personal computer5, 16
 pick up points, determining best locations6
 polarity.....15, 22
 polling.....31, 60
 power LED.....4, 25
 power supply13, 21
 de-energizing on malfunction3
 universal2
 PPM reading34, 45
 pressure connector13
 pressure sensor38
 printing screens and logs20
 programming25
 new gases.....42
 protective ground2, 14
 pump13, 48, 65
 purge line.....5, 10, 11, 37
 clearing19, 25
 max length6, 11
 purge port.....11, 39

R

R-123 gas cylinder and verification kit49
 R-134a gas cylinder and verification kit49
 R-22 gas cylinder and verification kit49

R407F6, 57, 68
 RD..... See Remote Display Module
 RDM setup screen #138
 reaction time71
 receive port44
 reducer kit48
 refrigerant.....5, 7, 11, 47, 64
 monitor vs. analyzer5
 register address44
 relays13, 23, 26, 35, 38, 64, 67
 connectors.....13, 23
 contacts4, 23
 in the RD.....6
 rating.....23
 Remote Display Module..6, 8, 15, 17, 31, 35, 36, 59, 60
 distance from MZ.....6
 max distance to MZ15
 remote monitoring equipment4
 repairiii, 3, 13
 repeatability.....71
 replacement of filters5
 replacement parts47, 48
 re-zero mode.....28
 re-zero volt tol36, 37
 RS-232.....16, 19, 20
 cable.....19, 20
 communications parameters19
 interface.....16, 19
 output20
 port5, 19
 RS-48528
 cable, max length17
 communications error.....38
 connector.....13, 15, 17
 fault.....38, 63
 interface.....5
 recommendations.....17
 wiring15

S

safety1, 2, 4, 6, 9, 13, 14, 48
 sample intake lines4, 9-11, 12, 37, 47, 48
 max length9, 12
 sample pump45, 48
 sample tubing.....5
 sampling cycle time.....9
 sampling points, suggested locations5
 saving screens and logs20
 Sealevel Systems, Inc.20
 sensitivity threshold.....7, 71
 minimum71
 sensor life.....8
 sensor temperature.....29, 45
 coefficient30
 serial port connection.....19

serviceii, 5, 13, 15, 16, 22, 23, 29, 61, 62, 67
 centers75
 knockout13
 mode28, 29, 62, 67
 set points5
 setup25
 menu27
 setup screen #228, 38
 shipping9, 13
 shock hazard2, 3, 14
 silence mode35
 smoke test6
 software screen20
 solenoid38
 connections4
 specifications ii, iii, 7, 8, 10, 41, 61
 spill 4, 6, 19, 23, 26, 33, 57, 62, 63, 64, 66
 alarm33
 level33
 splash screen25
 splitter kit12
 squelch setting27
 stand-alone system5
 static box34
 strobe24, 35
 surge protection2
 switches13
 system faults4, 8, 36
 LED4
 cleaning38
 system menu map69, 71
 system setup screen(s) 21, 27, 29, 41, 44
 screen #125
 screen #225, 26, 28, 31
 screen #328, 29

T

T-bolt bracket4
 temperature8
 coefficient29
 compensation44
 terminal connector38
 terminating multiple monitors17
 terminating the cable shield22
 termination switches13
 terminator(s)16, 17
 tolerance37
 transmit port44
 trend 20, 32, 38, 40, 41, 59
 graph40
 data20, 40, 41
 screen32, 35, 40

tubing8, 11, 12, 45, 47, 48, 71
 bend radius11
 installing11
 length32, 44
 removing11
 restrictions5
 twisted shielded pair15

U

UL classification3
 unused zones12
 disabling5
 UPS2
 upstream port17
 USB-to-serial converter19, 20

V

vacuum pressure44

W

warm up cycle25
 warm up screen25
 warnings and cautions1
 warrantyiii, 8
 registering on-lineiii
 voiding1, 3, 9, 14
 washers13
 water stop6, 12, 47, 48, 54
 website16
 wet installation area6
 Windows19, 20
 www.dataforth.com22

X

xls file extension20

Z

zero filter fault37, 63
 zeroing time71
 zone(s) 5, 8, 26, 27, 31, 32, 36-40, 48, 60, 61, 62, 63, 67
 current44
 hold mode43
 hold time27
 name34
 number27, 34, 61, 63
 setup screen5, 12, 31, 32, 35
 zones
 disabling12
 maximum number4





Headquarters:

621 Hunt Valley Circle, New Kensington, PA 15068-7074
Toll Free: 800-736-4666 • Tel: +1-724-334-5000 • FAX: +1-724-334-5001
Website: www.MyBacharach.com • E-mail: help@MyBacharach.com



Printed in U.S.A.

® Registered Trademark of Bacharach Inc.
