

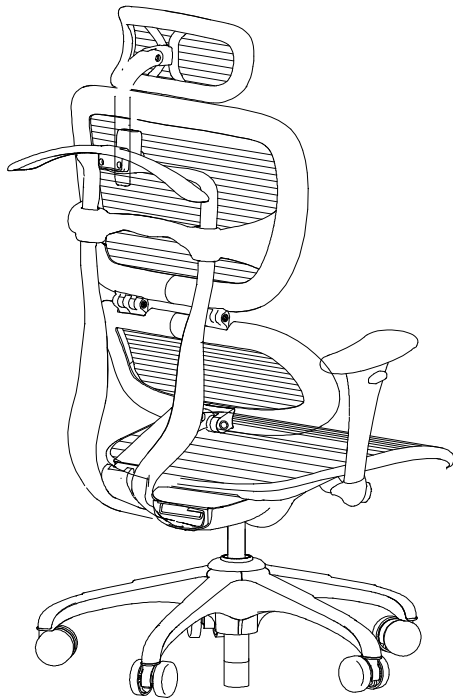















BLT-34729 Butterfly Chair Assembly Instructions



Parts/Hardware

P1		Cylinder	1 EA
P2		Base	1 EA
P3		Caster	5 EA
P4		Seat	1 EA
P5a		Left Arm	1 EA
P5b		Right Arm	1 EA
P6a		Arm Bolt	4 EA
P6b		Arm Lock Washer	4 EA
P7		Allen Wrench	1 EA
P8a		Back Bolt	3 EA
P8b		Back Lock Washer	3 EA
P9		Back Assembly	1 EA
P10		Head Rest	1 EA

Touchboards

205 Westwood Ave, Long Branch, NJ 07740
 Phone: 866-94 BOARDS (26273) / (732)-222-1511
 Fax: (732)-222-7088 | E-mail: sales@touchboards.com

Missing Parts or UPS Damaged Parts

For Your Convenience you can
 EMAIL us at

support@moorecoinc.com

24HOURS 7 DAYS A WEEK

1.) Push in five Casters (P3) into the Base (P2).
Insert the Cylinder (P1) into the Base (P2).

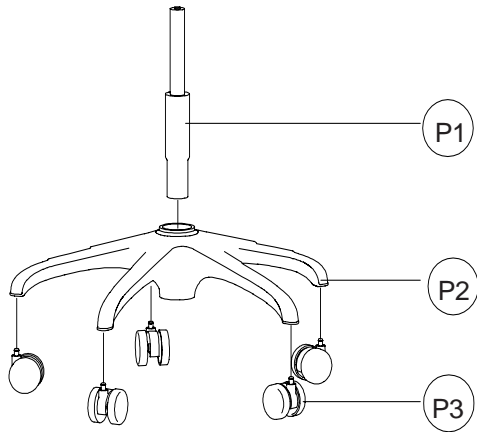

2.) Place the Seat (P4) on the top of the Cylinder (P1).

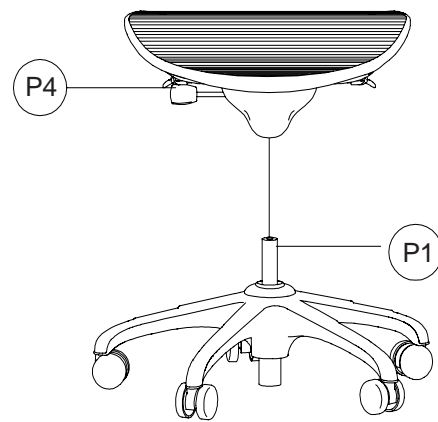

3.) Attach the Left Arm (P5a) to the Seat (P4) using two Arm Bolts (P6a) and two Arm Lock Washers (P6b). Attach the Right Arm (P5b) to the Seat (P4) using two Arm Bolts (P6a) and two Arm Lock Washers (P6b). Tighten with Allen Wrench (P7).

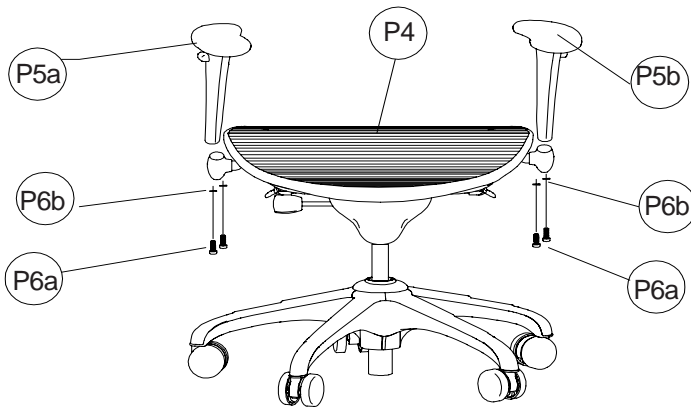

4.) Slide the Back Assembly (P9) into the rear of the Seat (P4) and secure with three Back Bolts (P8a) and three Back Lock Washers (P8b). Tighten with Allen Wrench (P7).

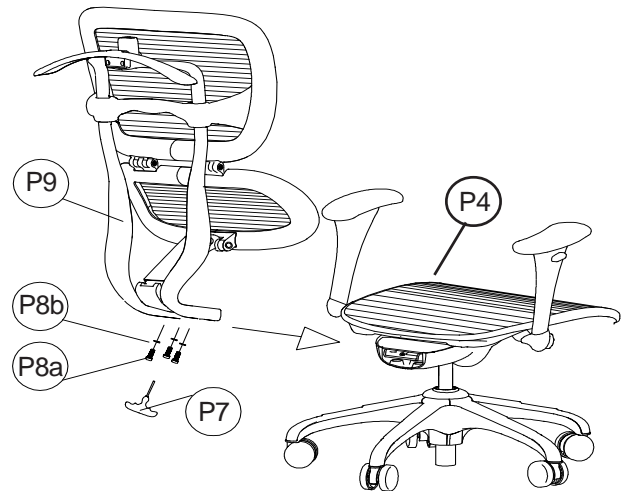

5.) Insert the Head Rest (P10) into the top of Back Assembly (P9).

