

BALT[®]

WIND-SURFER Tri-Level Computer Workstation

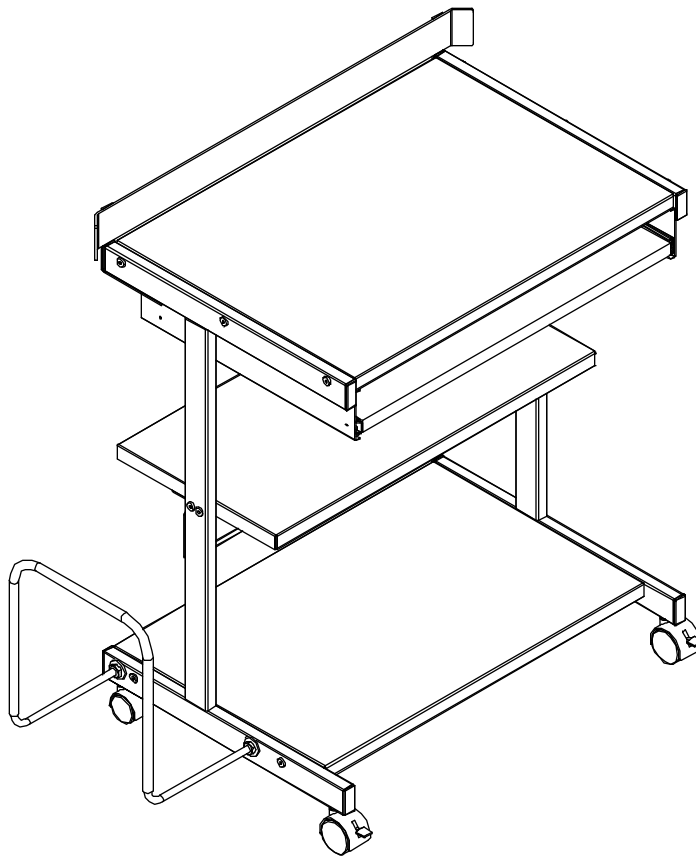











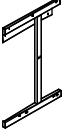



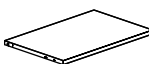



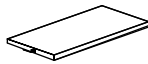

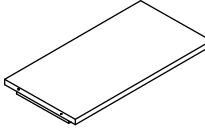

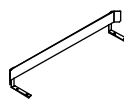
Touchboards

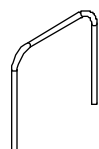
205 Westwood Ave, Long Branch, NJ 07740
Phone: 866-94 BOARDS (26273) / (732)-222-1511
Fax: (732)-222-7088 | E-mail: sales@touchboards.com

Assembly Instructions

Wind-Surfer

Tri Level Computer Workstation

Part	Drawing	Description	Qty	Part	Drawing	Description	Qty
P-1		Right Leg	1 EA	Hardware List			
P-2		Left Leg	1 EA	A		9/16" Flat Head Screw	8 EA
P-3		Top Platform	1 EA	A1		1-7/8" Flat Head Screw	14 EA
P-4		Bottom Shelf	1 EA	B		Square Nut	14 EA
P-5		Stability Panel	1 EA	C		Sheet Metal Screw	2 EA
P-6		Middle Shelf	1 EA	D		2" Locking Caster (for front)	2 EA
P-7		Keyboard Platform	1 EA	E		2" Caster (for Back)	2 EA
P-8		Monitor Rail	1 EA	F		Allen Wrench	1 EA
P-9		CPU Sleeve	2 EA	G		Caster Wrench	1 EA
P-10		CPU Rod	1 EA	H		Hex Nut	4 EA
				J		Flat Washer	2 EA
				K		Black Plastic Spacer	2 EA
				L		Inner Slide	2 EA
				M		Long Screws	4 EA
				Tools required: Phillips Head Screw Driver			

READ THROUGH INSTRUCTIONS FROM BEGINNING TO END BEFORE STARTING TO ASSEMBLE UNIT.

Do not use unless all screws are tight. At least every six months, check all screws to be sure they are tight. If parts are missing, broken, damaged, or worn, stop use of the product until repairs are made by your dealer using factory authorized parts.

WIND-SURFER Assembly Diagram

BALT®

Illustration # 1

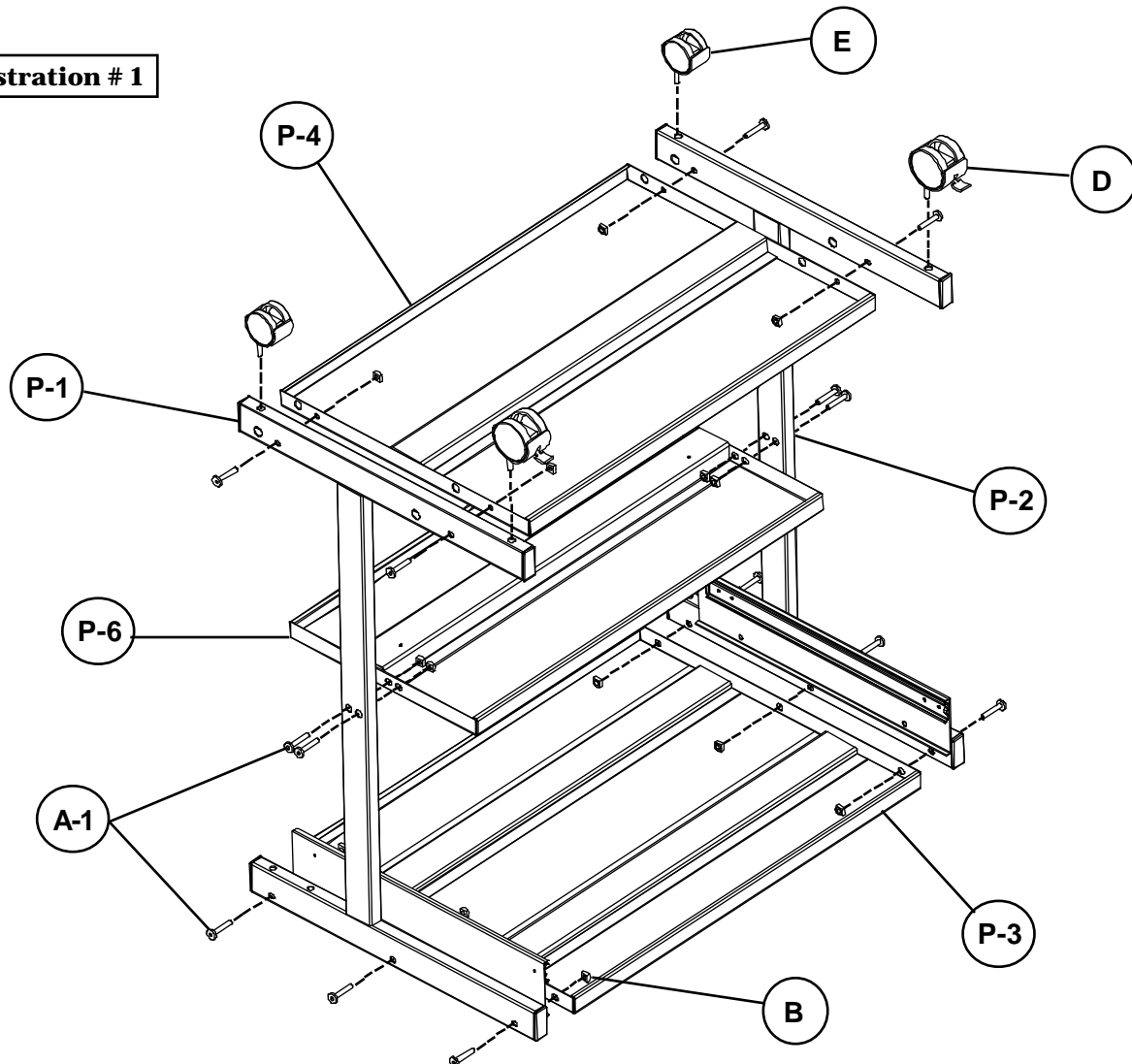

To Assemble:

1. Separate and Identify all the Parts and Hardware.
2. Place Top Panel (P-3) upside down on floor or table and attach Right Leg (P-1) and Left Leg (P-2) using 6 Flat Head Screws (A1) and 6 Square nuts (B) as shown in illustration # 1. (*Hand tighten only*)
3. Attach Middle Shelf (P-6) to Right Leg (P-1) and Left Leg (P-2) using 4 Flat Head Screws (A1) and 4 Square nuts.
4. Attach Bottom Shelf (P-4) to Right Leg (P-1) and Left Leg (P-2) using 4 Flat Head Screws (A1) and 4 Square nuts (B).
5. Attach 2 Locking Casters (D) to the front, and 2 Casters (E) to the back of the unit. Tighten all Casters using Caster Wrench (G).

***Should you require assistance during assembly, please call our
Customer Service Department Monday - Friday 8 a.m. - 5 p.m. Central Standard Time***

Toll-Free Customer Service - 1-800-749-2258

6. Attach Stability Panel (P-5) to Right Leg (P-1) and Left Leg (P-2) using 4 Flat Head Screws (A).

7. Secure Middle Shelf (P-6) with 2 Sheet Metal Screws (C) through holes in Stability Panel (P-5) as shown in illustration # 2.

Illustration # 2

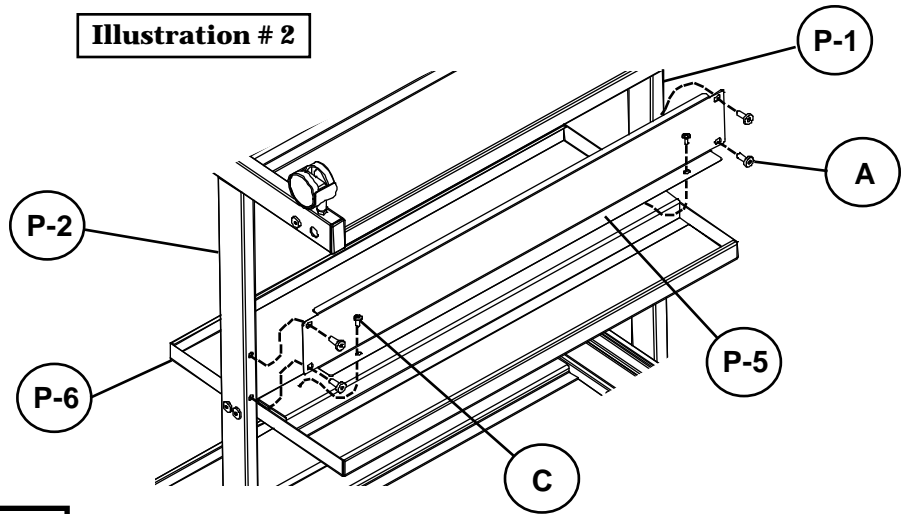
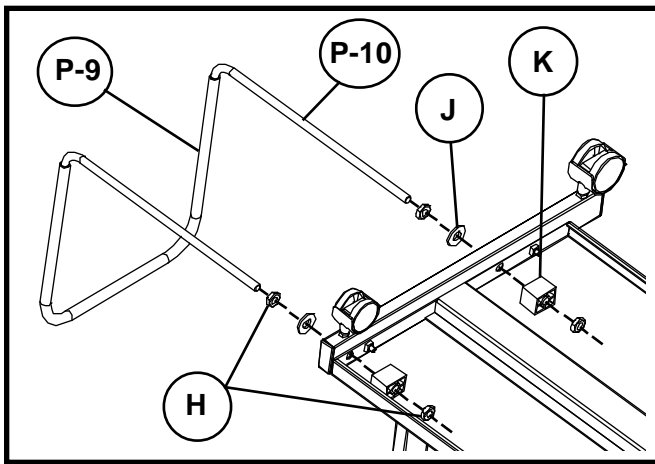

Illustration # 3



8. Place 1 each Hex Nut (H), and 1 each Flat Washer (J) on each CPU Rod (P-10). Insert 2 CPU Rods through the Right Leg (P-1) or the Left Leg (P-2) as shown in illustration # 3.

9. Place 1 each Black Plastic Spacer (K) over each CPU Rod and secure each Rod with 1 each Hex Nut (H). Slide CPU Sleeve (P-9) over ends of CPU Rods as shown in illustration # 3.

10. Attach Monitor Rail (P-8) to Right Leg (P-1) and Left Leg (P-2) using 4 Flat Head Screws (A) as shown in illustration # 4. Tighten all the Screws securely using Allen Wrench (F).

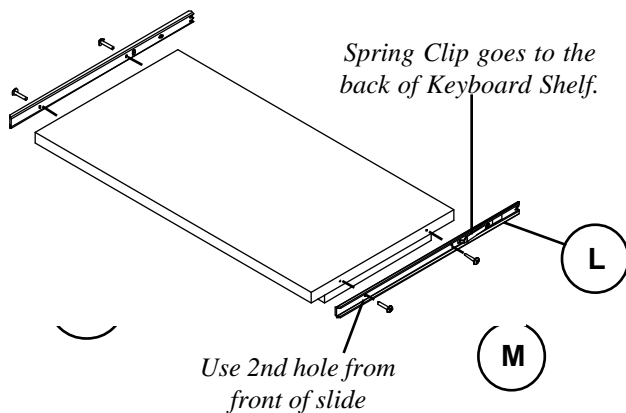

11. Attach 2 Inner slides (L) to the Keyboard Platform (P-7) using 4 Long screws (M). Insert Keyboard Assembly into the 'Slides' on the Right and Left Legs (P-1 & P-2) as shown in illustration # 4. (*Before inserting Keyboard assembly, pull the 'Rollers' to the front of the Slide.*)

Illustration # 4

