

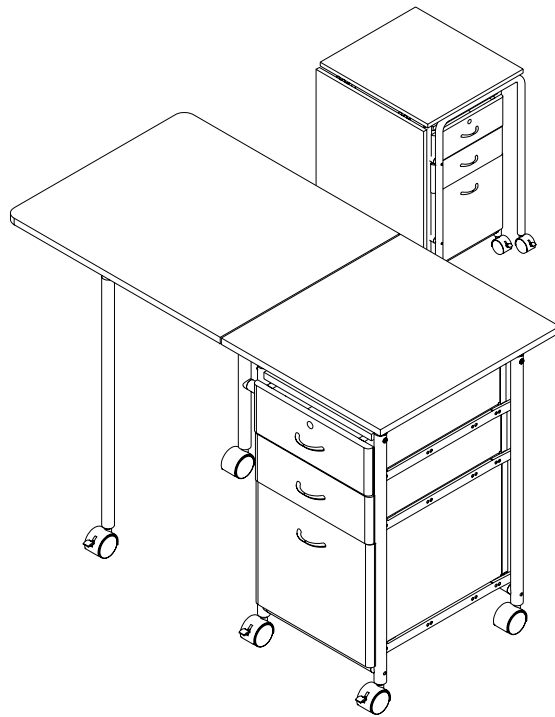









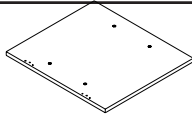
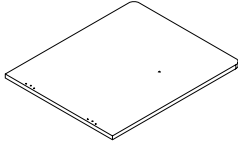
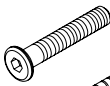
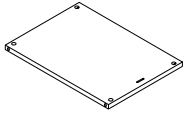
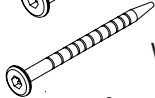
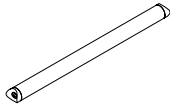

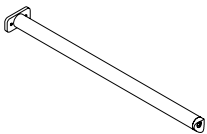

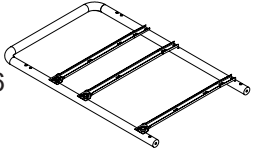

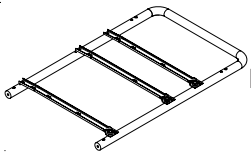

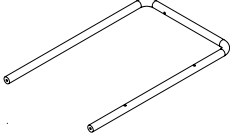

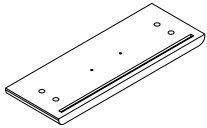

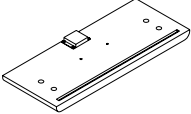
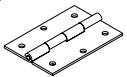
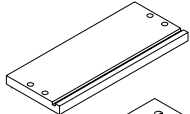
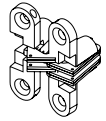
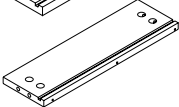
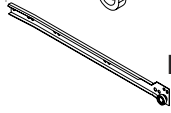
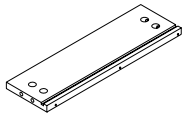
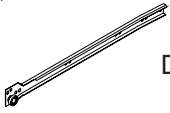
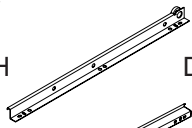
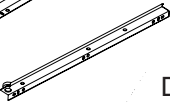
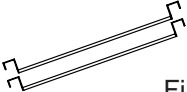



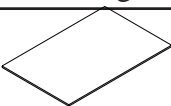

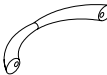
#89904 Fold-N-Stow

Portable Desk w/Drawers

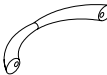

Assembly Instructions

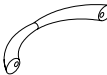
Part	Drawing	Description	Qty	Part	Drawing	Description	Qty
P-1		Top Panel-Drawer	1 EA	Hardware List			
P-2		Folding Top	1 EA	A		Socket Screw M6x35mm	14 EA
P-3		Shelf Panel	1 EA	A1		Wood Screw M5x55	4 EA
P-4		Drawer Brace	4 EA	A2		Phil Flat M4x10mm Return Hinges	8 EA
P-5		Return Brace	2 EA	A3		Phil Flat Wd Screw M3.8x12 Drawer Slides	12 EA
P-6		Left Drawer Leg w/holes for Hinges	1 EA	A4		Phil Pan Hd M4 X 18 Drawer Handle	6 EA
P-7		Right Drawer Leg	1 EA	A5		Phil Pan Wd Screw M3.5 X 12 Flat Hinges	12 EA
P-8		Return Leg	1 EA	B		Cam Post	24 EA
P-9		Drawer Front	1 EA	C		Cam Lock	24 EA
P-10		Drawer Front w/Lock (For Locking Drawer)	1 EA	D		Flat Hinge	2 EA
P-11		Drawer Back	2 EA	E		Return Hinge	2 EA
P-12		Left Drawer Side	2 EA	F		Drawer Slide(Outer-left) (Factory installed on leg)	3 EA
P-13		Right Drawer Side	2 EA	G		Drawer Slide(Outer-right) (Factory installed on leg)	3 EA
				H		Drawer Slide(Inner-left)	3 EA
				J		Drawer Slide(Inner-right)	3 EA
				J-1		File Drawer Hangers	2 EA
				K		2" Locking Caster (for front)	3 EA
				L		2" Caster (for Back)	3 EA

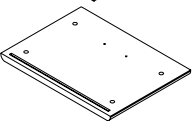
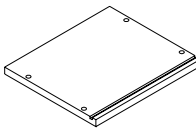
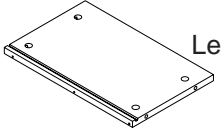
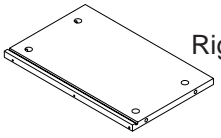
Part	Drawing	Description	Qty	Part	Drawing	Description	Qty																
P-14		Drawer Bottom	3 EA	<div style="border: 2px solid black; border-radius: 15px; padding: 10px;"> <p style="text-align: center; margin: 0;">Hardware List</p> <table style="width: 100%; border-collapse: collapse;"> <tr> <td style="width: 5%; text-align: center;">M</td> <td style="width: 15%;"></td> <td style="width: 60%;">Threaded Steel Pin</td> <td style="width: 20%; text-align: center;">1 EA</td> </tr> <tr> <td style="text-align: center;">N</td> <td></td> <td>Key</td> <td style="text-align: center;">2 EA</td> </tr> <tr> <td style="text-align: center;">P</td> <td></td> <td>Drawer Handle</td> <td style="text-align: center;">3 EA</td> </tr> <tr> <td style="text-align: center;">R</td> <td></td> <td>Allen Wrench</td> <td style="text-align: center;">1 EA</td> </tr> </table> </div>				M		Threaded Steel Pin	1 EA	N		Key	2 EA	P		Drawer Handle	3 EA	R		Allen Wrench	1 EA
M		Threaded Steel Pin	1 EA																				
N		Key	2 EA																				
P		Drawer Handle	3 EA																				
R		Allen Wrench	1 EA																				
P-15		File Drawer Front	1 EA																				
P-16		File Drawer Back	1 EA																				
P-17		Left File Drawer Side	1 EA																				
P-18		Right File Drawer Side	1 EA																				

Fold-N-Stow Assembly Diagram

To Assemble:

1. Identify and Separate all the Parts and Hardware.
2. Place the Top Panel-Drawer (P-1) with the Predrilled holes facing up. Align the Folding Top (P-2) Next to the Top Panel-Drawer (P-1) as shown in illustration #1. Attach 2 Flat Hinges (D) using 12 Wood Screws (A5) as shown in illustration # 1.

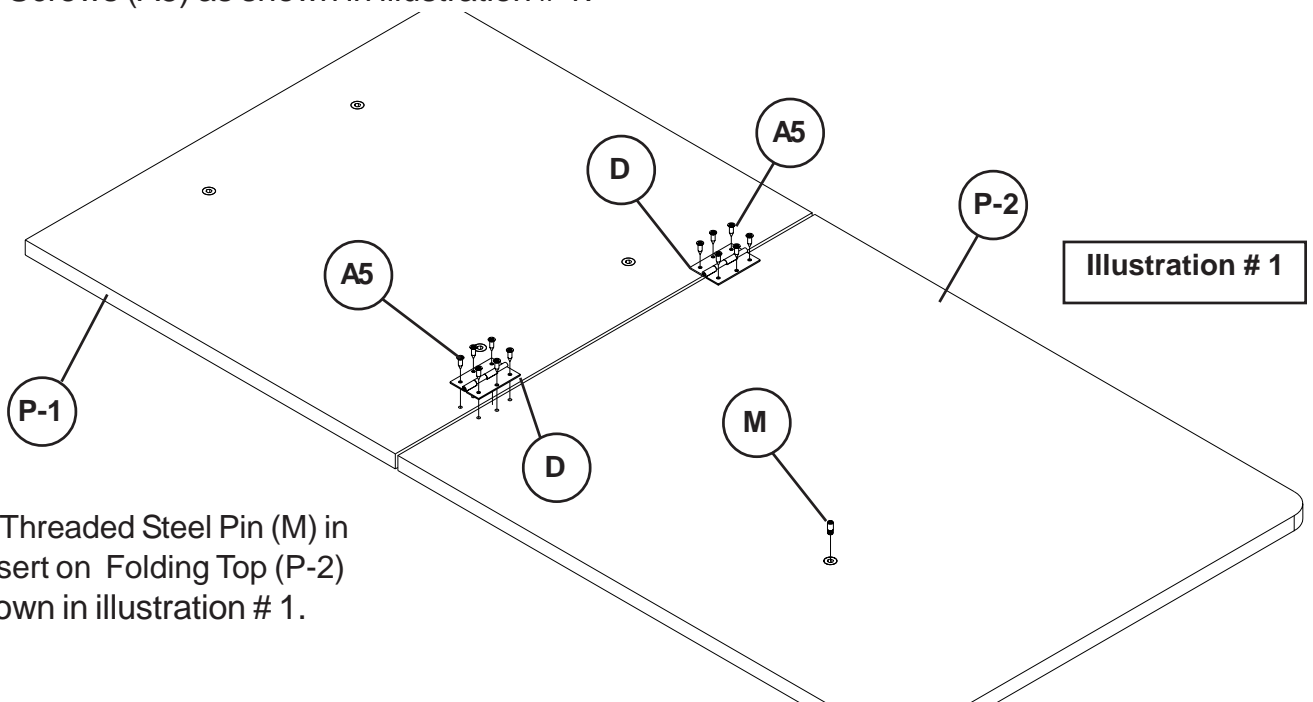

3. Insert Threaded Steel Pin (M) in Nut insert on Folding Top (P-2) as shown in illustration # 1.

4. Place 4 Drawer Braces (P-4) between the Left Drawer Leg (P-6) and the Right Drawer Leg (P-7). Secure using 8 Screws (A) as shown in illustration # 2.

5. Slide the Shelf Panel (P-3) between the Left Drawer Leg (P-6) and the Right Drawer Leg (P-7) as shown in illustration # 2. Secure using 4 Screws (A1) .

6. Insert 2 Return Hinges (E) in the holes in the Left Drawer Leg (P-6) as shown in illustration # 2. Secure using 4 Screws (A2).

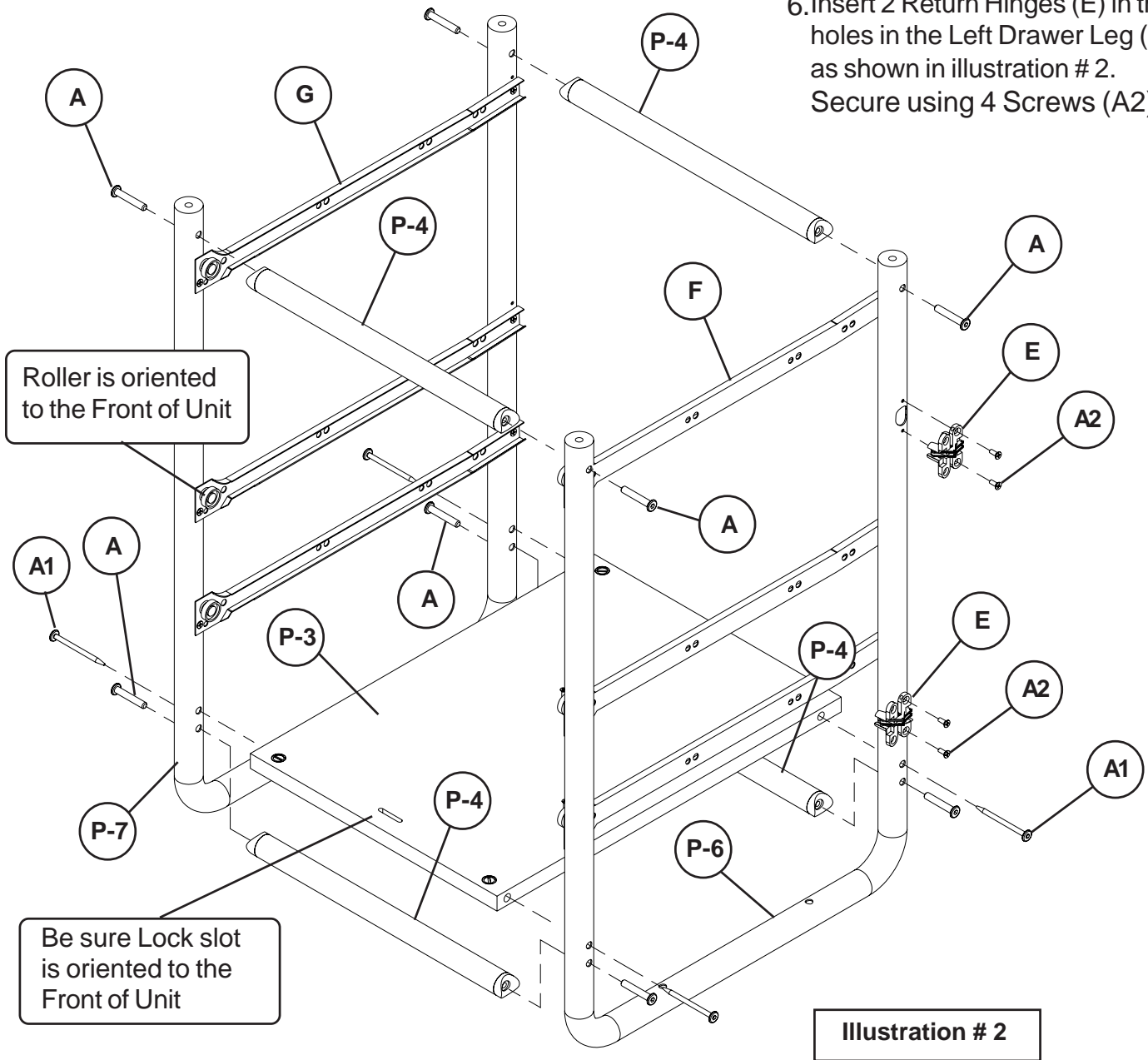

Do not use unless all screws are tight. At least every six months, check all screws to be sure they are tight. If parts are missing, broken, damaged, or worn, stop use of the product until repairs are made by your dealer using factory authorised parts.

**Should you require assistance during assembly,
please call our Customer Service Department
Monday - Friday 8 a.m. - 5 p.m. Central Standard Time
Toll-Free Customer Service
1-800-749-2258**

Illustration # 3

7. Place the Top Panel-Drawer (P-1) with the Predrilled holes facing up. Attach the Left Drawer Leg (P-6) and the Right Drawer Leg (P-7) using 4 Screws (A) as shown in illustration # 3.

8. Attach 2 Return Brace (P-5) to the 2 Return Hinges (E) using 4 screws (A2) as shown in illustration #3.

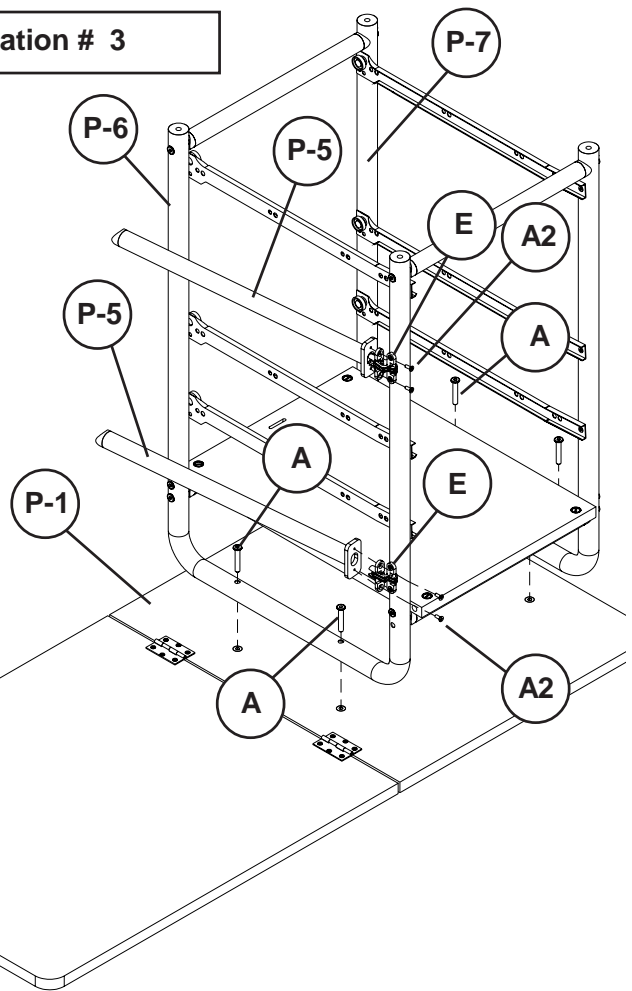
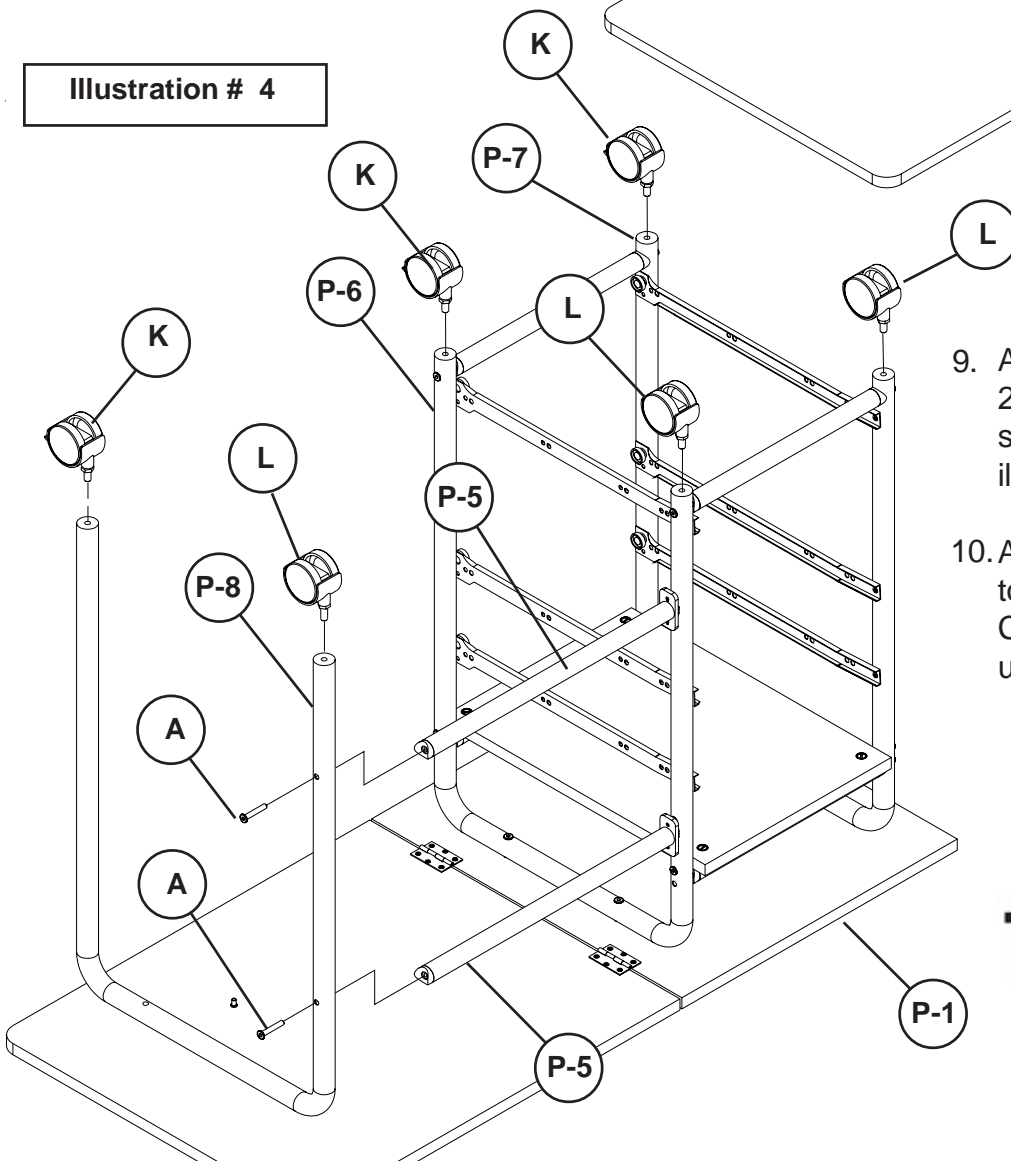

Illustration # 4



9. Attach Return Leg (P-8) to the 2 Return Braces (P-5) using 2 screws (A) as shown in illustration #4.

10. Attach 3 Locking Casters (K) to the front of the unit and 3 Casters (L) to the back of the unit.

Tighten Socket Screws using Allen Wrench (R)

Touchboards

205 Westwood Ave, Long Branch, NJ 07740
Phone: 866-94 BOARDS (26273) / (732)-222-1511
Fax: (732)-222-7088 | E-mail: sales@touchboards.com

11. Place the 2 Left Drawer Sides (P-12) and 2 Right Drawer Sides (P-13) with the Holes facing up and install 16 Cam Locks (C) into the large holes in each side as shown in illustration # 5.

Illustration # 5

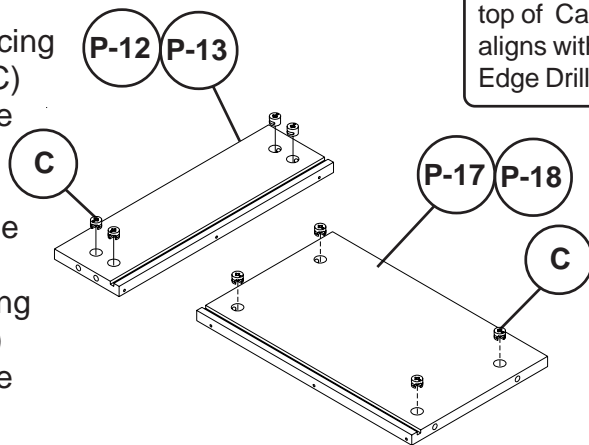

Be sure that arrow on top of Camlock (N) aligns with centerline of Edge Drilled hole.

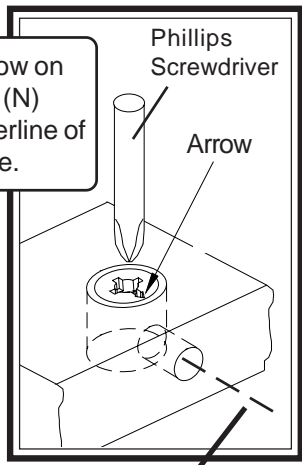

Centerline of Edge Drilled hole.

12. Place the Left File Drawer Side (P-17) and Right File Drawer Side (P-18) with the Holes facing up and install 8 Cam Locks (C) into the large holes in each side as shown in illustration # 5.

13. Place the Drawer Front (P-9), Drawer Front -Lock (P10) & File Drawer Front (P-15) with the Predrilled holes facing up and install 12 Cam Posts (B) in the 12 threaded insert nuts (Pre-installed) as shown in illustration # 6.

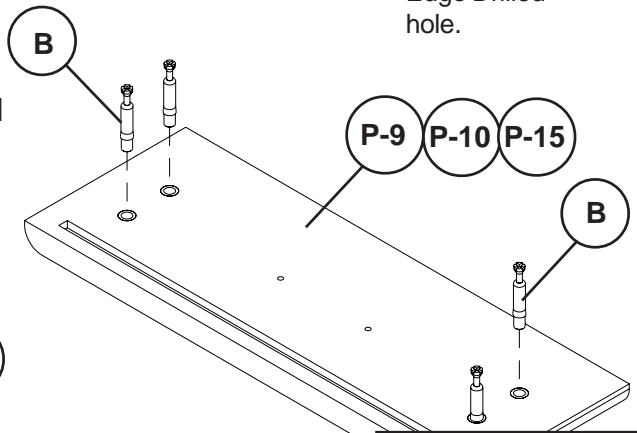
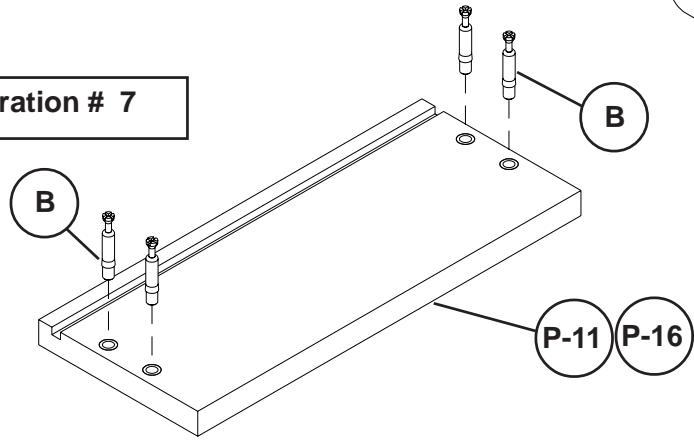

Illustration # 6

Illustration # 7



14. Place the 2 Drawer Backs (P-11) & the File Drawer Back (P-16) with the Predrilled holes facing up and install 12 each Cam Posts (B) in the 12 threaded insert nuts (Pre-installed) as shown in illustration # 7.

15. Attach the Drawer Front (P-9) to the Left Drawer Side (P-12) and Right Drawer Side (P-13). Attach the Drawer Front w/Lock (P-10) to the Left Drawer Side (P-12) and Right Drawer Side (P-13). Secure by turning the Cam Locks (C) 1/4 Turn until they lock as shown in illustration # 8.

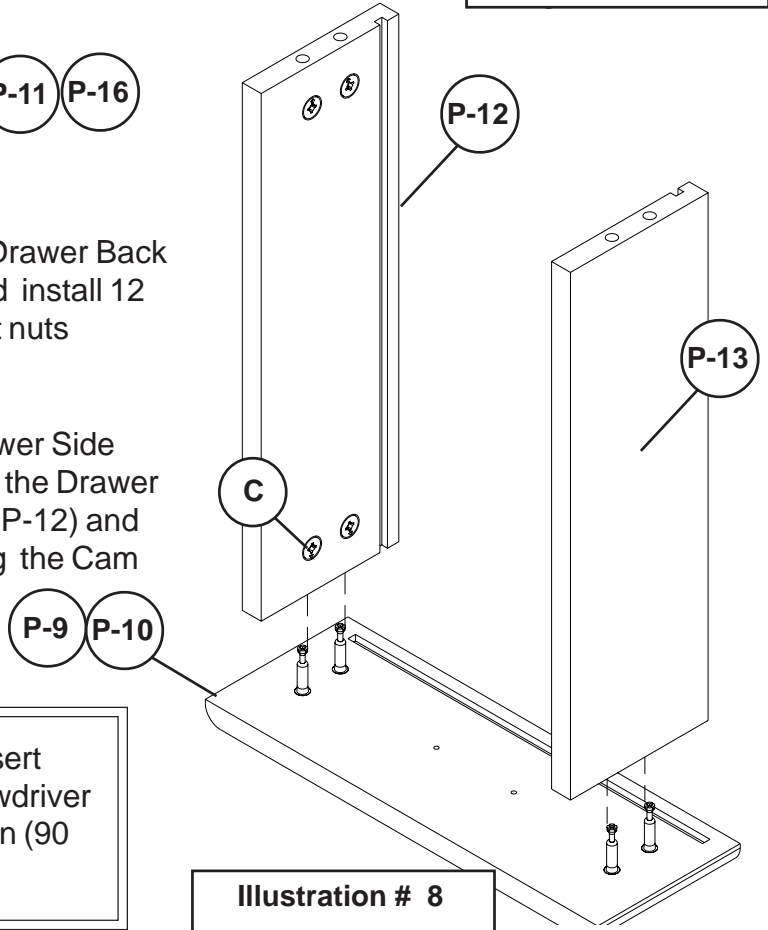
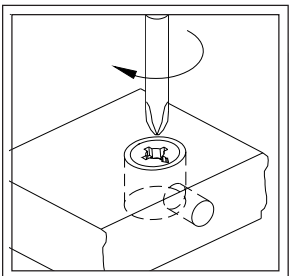

Illustration # 8



To Secure Cam Locks, Insert Large Phillips Head Screwdriver and turn Cam Lock 1/4 turn (90 degrees) clockwise.

16. Slide Drawer Bottom (P-14) into the slot in the Left & Right Drawer Sides (P-12 & P-13) as shown in illustration # 9.

17. Attach the Drawer Back (P-11) to the Left & Right Drawer Sides (P-12 & P-13). Secure by turning the Cam Locks (C) 1/4 turn until they lock as shown in illustration # 9.

18. Repeat Steps 16 & 17 for 2nd Drawer using Drawer Front -Lock (P-10).

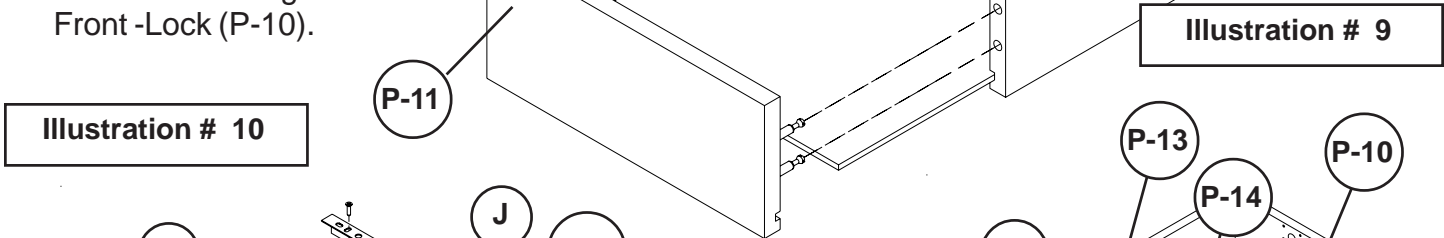

Illustration # 10

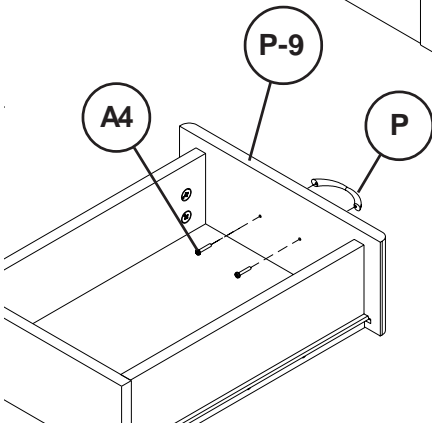
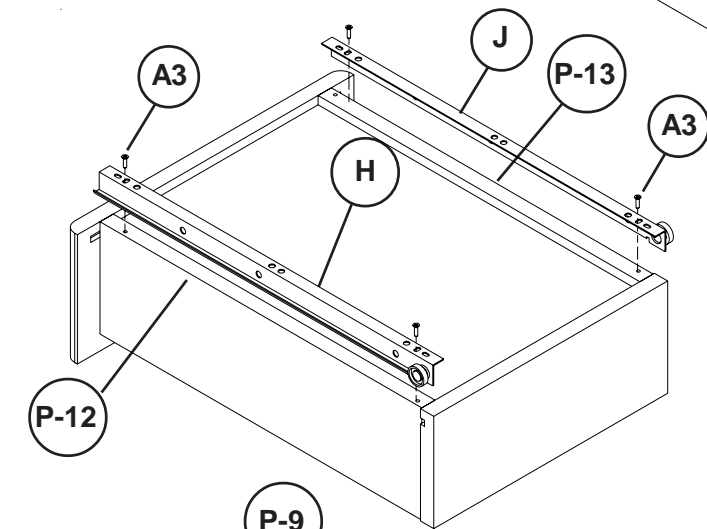
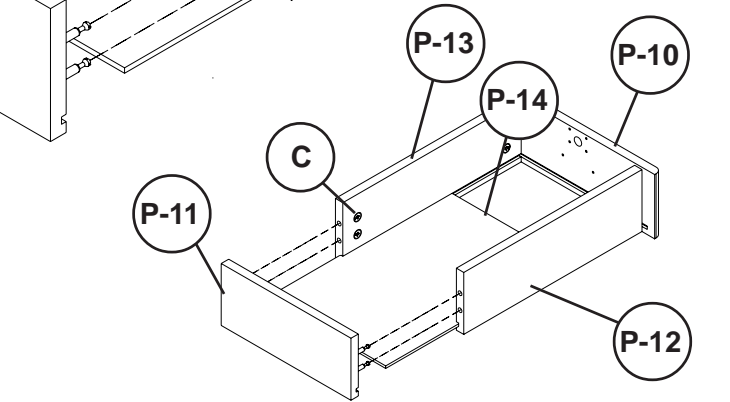

Illustration # 11

22. Attach Drawer Handle (R) to Drawer Front-Lock (P-10) using 2 screw (A4) as shown in illustration # 12.



19. Align Drawer Slide-Inner Left (H) and Drawer Slide-Inner Right (J) to the Left Drawer Side (P-12) & Right Drawer Side (P-13). Secure using 4 screws (A3) as shown in illustration # 10.

20. Repeat Step 19 for 2nd Drawer.

21. Attach Drawer Handle (P) to Drawer Front (P-9) using 2 screw (A4) as shown in illustration # 11.

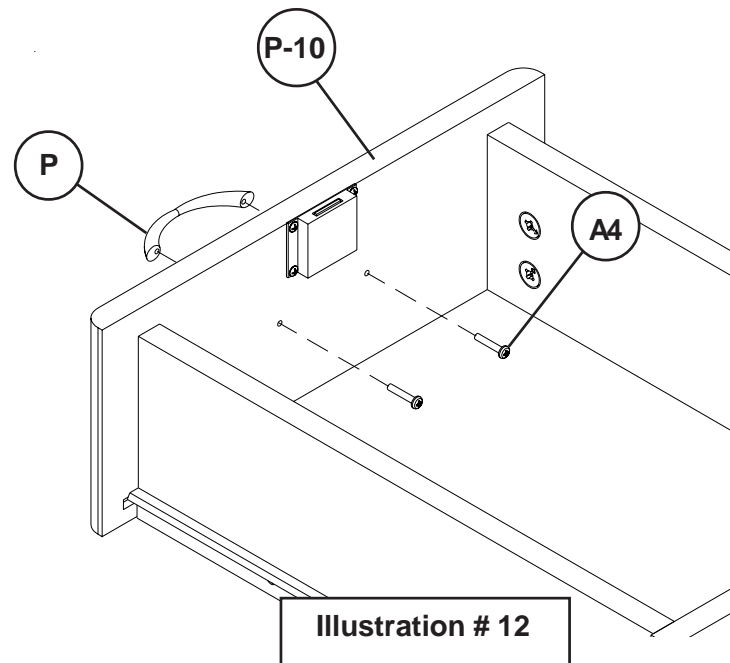
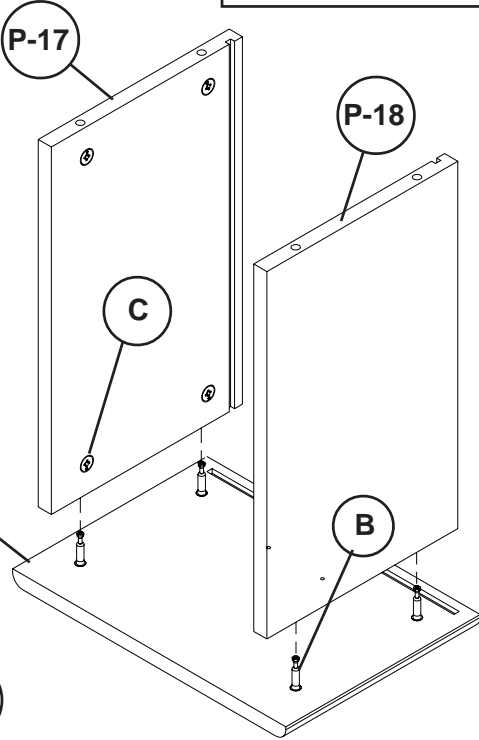

Illustration # 12

23. Attach the File Drawer Front (P-15) to the Left & Right File Drawer Sides (P-17 & P-18) and secure by turning the Cam Locks (C) 1/4 Turn until they lock as shown in illustration # 13.

Illustration # 13



24. Slide Drawer Bottom (P-14) into the slot in the Left & Right File Drawer Sides (P-17 & P-18) as shown in illustration # 14.

25. Attach the File Drawer Back (P-16) to the Left & Right File Drawer Sides (P-17 & P-18). Secure by turning the Cam Locks (C) 1/4 Turn until they lock.

Illustration # 14

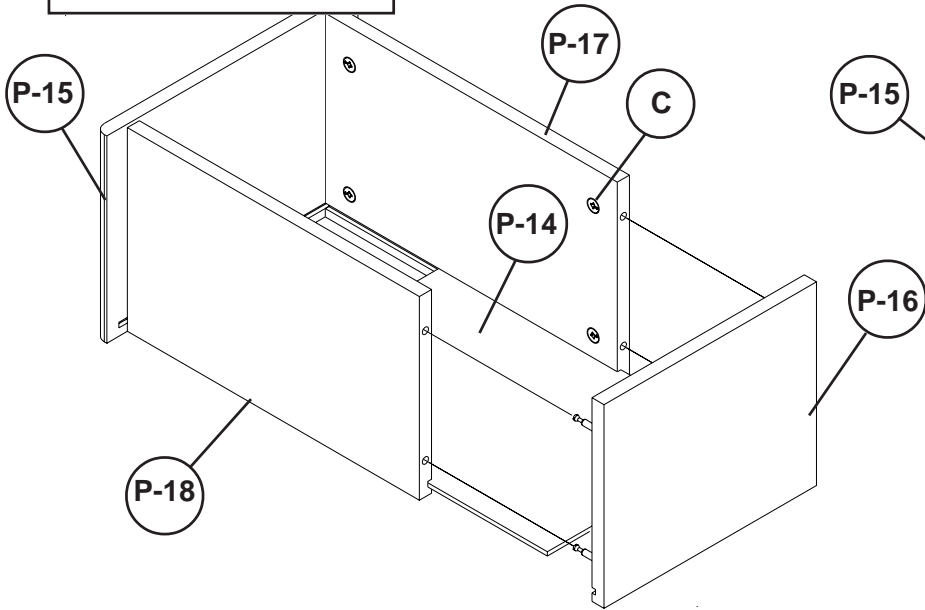

26. Align Drawer Slide-Inner Left (H) and Drawer Slide-Inner Right (J) to the Left & Right File Drawer Sides (P-17 & P-18). Secure using 4 screws (A3) as shown in illustration # 15.

Illustration # 15

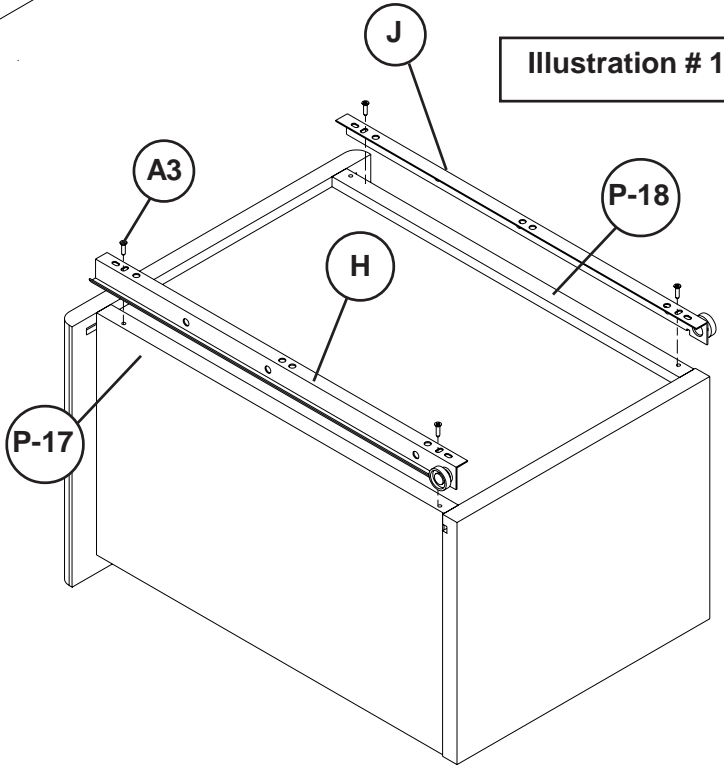
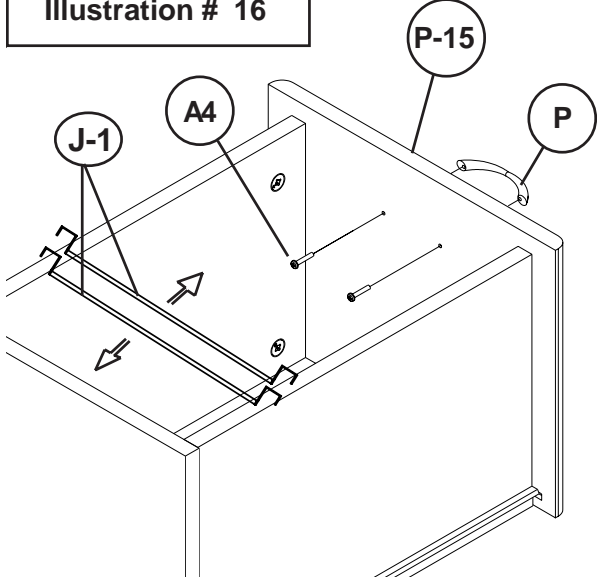

Illustration # 16



27. Attach Drawer Handle (P) to File Drawer Front (P-15) using 2 screw (A4) as shown in illustration # 16. Attach File Drawer Hangers (J-1) on drawer sides.

28. Tilt front of Drawer and drop roller on Inner Drawer Slides (H & J) behind roller on Outer Drawer Slides (F & G) as shown in illustration # 17.

Illustration # 17

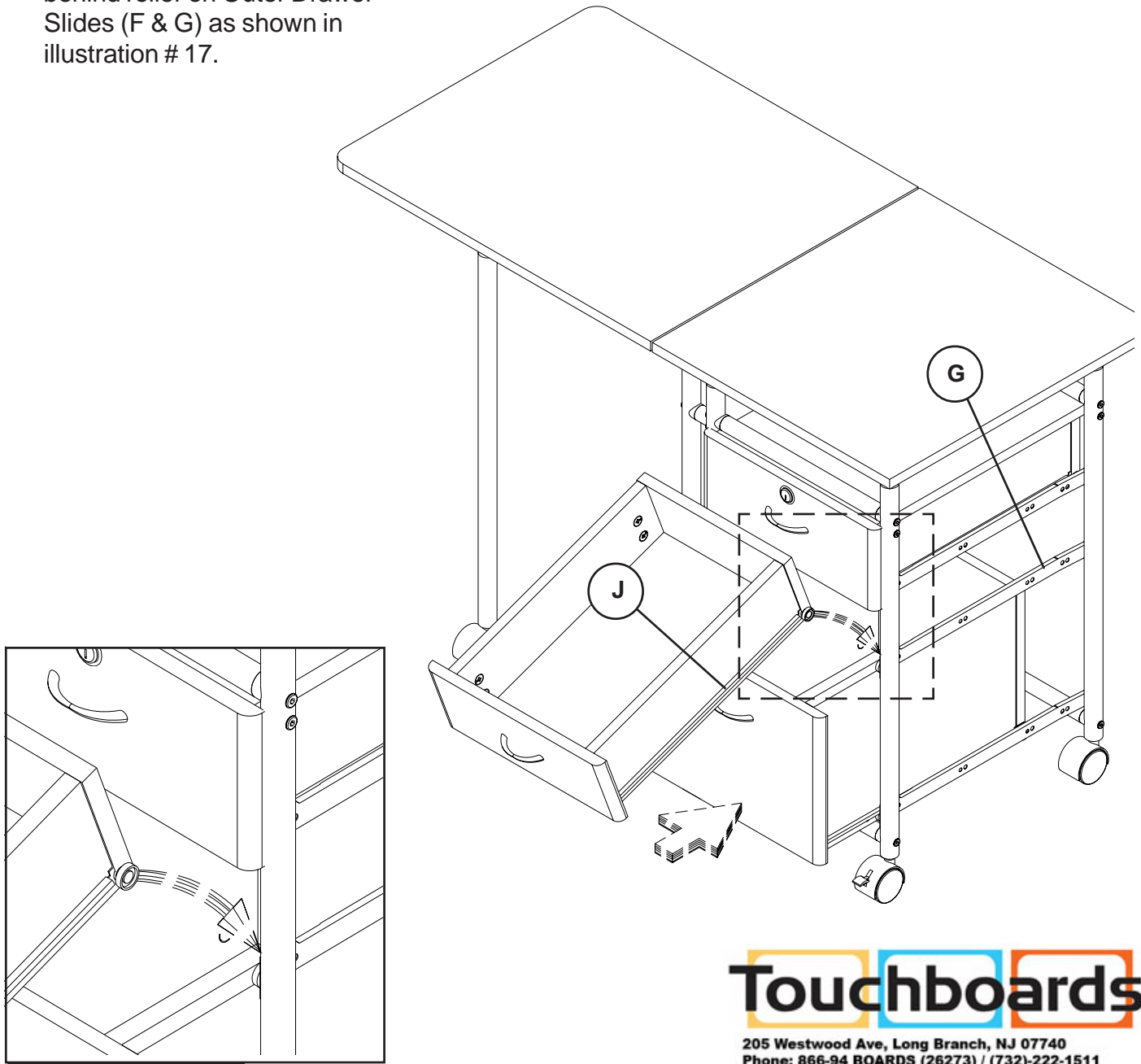

Detail # 19

Touchboards

205 Westwood Ave, Long Branch, NJ 07740
Phone: 866-94 BOARDS (26273) / (732)-222-1511
Fax: (732)-222-7088 | E-mail: sales@touchboards.com

Important

The Balt product you have purchased is guaranteed against material and workmanship defects. This guarantee extends 1 year from date of purchase. Should this product fail to function satisfactorily under normal use due to defect or imperfection, the defective part or product will be replaced. Damage caused by common carriers during shipment is not included in this guarantee.

This guarantee sets forth all applicable guarantees and remedies. No other warranty, expressed or implied shall apply. Failure to follow instructions found in Important Information Section of Owner Sheet shall void the guarantee. Consequential or incidental damages and or costs are not refundable.