



Digital Projector

User Manual

Portable Series | GS50

V 1.00

Product support

This document aims to provide the most updated and accurate information to customers, and thus all contents may be modified from time to time without prior notice. Please visit the website for the latest version of this document and other product information. Available files vary by model.

1. Make sure your computer is connected to the Internet.
2. Visit the local website from Support.BenQ.com. The website layout and content may vary by region/country.

Search for your model's user manual and related document.

Servicing

- If misuse or other accident occurs, contact qualified service personnel for servicing.
- Contact your place of purchase or visit the local website from Support.BenQ.com for more support.



Support.BenQ.com

Q&A Index

Start with the topics you are interested in:

Setup

How do I set up the projector and turn it on?

Choosing a location	28
Operations	30

Calibration and Image Editing

How do I adjust the focus of the projected image?

Adjusting the projection angle	38
Fine-tuning the image clarity	39
Correcting keystone	40
Corner Fit	41

How do I adjust the projector for outdoor use?

Using the projector in an outdoor setting	29
Product care after outdoor use	65

Usage

How do I play music via the projector?

Using the built-in speaker on the projector	45
Using the projector as a Bluetooth speaker	53

How do I use voice control?

Google Assistant	44
------------------	----

Can I charge my device via the projector's USB-C port?

Charging the battery	32
----------------------	----

How do I prevent kids from accidentally pressing the buttons on the projector or remote control?

Panel key lock	18
----------------	----

Maintenance and Product Support

What should I do if I don't plan to use the projector for a long time?

Storing the projector

64

How do I clean my projector after outdoor use?

Product care after outdoor use

65

Important safety instructions

9

Table of contents

Product support	2
Servicing.....	2
Q&A Index	3
Package contents	12
Standard accessories.....	12
Introduction	14
Projector exterior view	14
Front, top, and left side view	14
Rear, bottom, and right view	16
Dimensions.....	17
Ports	18
LED indicators	19
Remote control.....	22
Installing/Replacing the remote control batteries	24
Remote control effective range.....	25
BenQ Smart Control (remote control app)	26
Installation	28
Choosing a location	28
Using the projector in an outdoor setting.....	29
Operations	30

Installing the ATV dongle.....	30
Charging the battery	32
Starting up the projector	33
Shutting down the projector	37
Adjusting the projected image	38
Adjusting the projection angle	38
Fine-tuning the image clarity.....	39
Correcting keystone.....	40
Corner Fit	41
Android TV	42
The Android TV home screen.....	42
Google Assistant	44
Playing music via the projector	45
Using the built-in speaker on the projector	45
Using the projector as a Bluetooth speaker	45
Connections	46
Switching between Android TV and input sources	48
Wireless connections	49
Wireless projection.....	49
Wired connections.....	50
Connecting a device with HDMI or USB-C with DisplayPort.....	50
Connecting a flash drive	51
Bluetooth connections	53
Using the projector as a Bluetooth speaker	53
Pairing/Connecting to a Bluetooth speaker or headphones	54

Navigating the settings menu	56
About the settings menu	56
Using the Settings menu.....	57
Brightness	58
Picture Mode	58
Sound Mode	59
Picture	59
Power Mode	60
Eye Protection	60
Parental Control	61
Installation	61
System	63
Maintenance	64
Care of the projector	64
Cleaning the lens.....	64
Storing the projector	64
Transporting the projector	65
Product care after outdoor use	65
Extending LED life	65
Troubleshooting	67
Specifications	70
Projector specifications	70
Timing chart.....	72
Supported file formats.....	75
Appendix	76
Installing the projector on a tripod (purchased separately)	76
Copyright and disclaimer	77

Copyright	77
Disclaimer	77
Warranty	77
Statement regarding hyperlinks and third-party websites	78

Important safety instructions

Your projector is designed and tested to meet the latest standards for safety of information technology equipment. However, to ensure safe use of this product, it is important that you follow the instructions mentioned in this manual and marked on the product.

1. Please read this user manual before you operate your projector.
Keep this manual in a safe place for future reference.

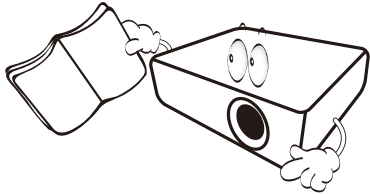

2. Always place the projector on a level, horizontal surface during operation.
 - Do not place the projector on an unstable cart, stand, or table as it may fall and be damaged.
 - Do not place inflammables near the projector.
 - Do not use if tilted at an angle of more than 10 degrees left to right, nor at angle of more than 15 degrees front to back.

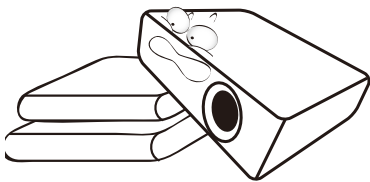

3. Do not store the projector on end vertically. Doing so may cause the projector to fall over, causing injury or resulting in damage.

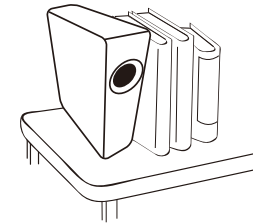

4. Do not place the projector in any of the following environments:
 - Space that is poorly ventilated or confined. Allow at least 50 cm clearance from walls and free flow of air around the projector.
 - Locations where temperatures may become excessively high, such as the inside of a car with all windows closed.
 - Locations where excessive humidity, dust, or cigarette smoke may contaminate optical components, shorten the projector's lifespan and darken the screen.

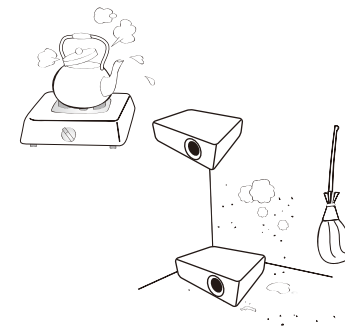

- Locations near fire alarms.
- Locations with an ambient temperature above 40°C/104°F.

- Locations where the altitudes are higher than 2000 m (6562 feet).

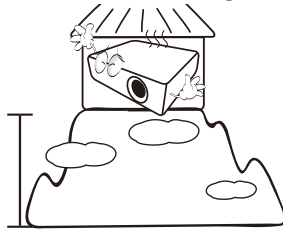

- Do not block the vents holes while the projector is on (even in power-saving mode).
 - Do not cover the projector with any item.
 - Do not place the projector on a blanket, bedding or any other soft surface.

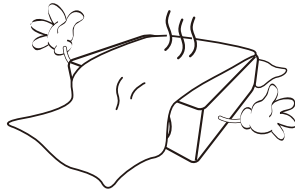

- In areas where the mains power supply voltage may fluctuate by ± 10 volts, it is recommended that you connect the projector through a power stabilizer, surge protector or uninterruptible power supply (UPS) as appropriate to your situation.

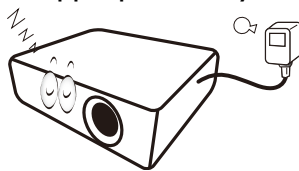

- Do not step on the projector or place any objects upon it.



- Do not place liquids near or on the projector. Liquids spilled into the projector will void your warranty. If the projector does become wet, disconnect it from the power point and call BenQ to have the projector repaired.

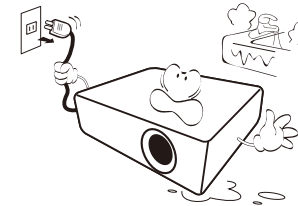

- Do not look straight into the projector lens during operation. It may harm your sight.

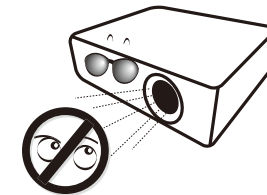

- Do not operate the projector LED beyond the rated LED life. Excessive operation of LEDs beyond the rated life could cause LEDs to break on rare occasions.

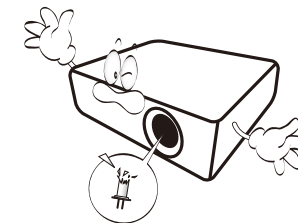

- This projector is capable of displaying inverted images for ceiling installation.

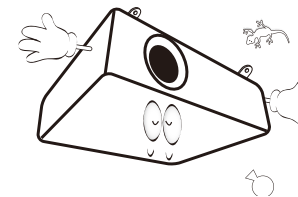

12. Do not attempt to disassemble this projector. There are dangerous high voltages inside which may cause death if you should come into contact with live parts.

Under no circumstances should you ever undo or remove any other covers. Refer servicing only to suitably qualified professional service personnel.

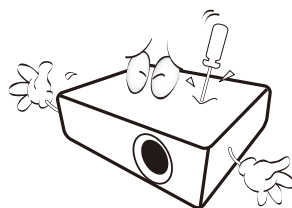

- !** Please keep the original packing for possible future shipment. If you need to pack your projector after use, adjust the projection lens to an appropriate position, put the lens cushion around the lens, and fit the lens cushion and projector cushion together to prevent damage during transportation.

13. When you think service or repair is required, take the projector only to a suitably qualified technician.

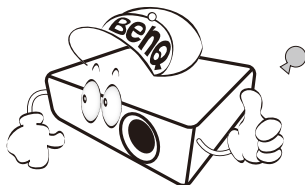

Moisture condensation

Never operate the projector immediately after moving it from a cold location to a hot location. When the projector is exposed to such a change in temperature, moisture may condense on the crucial internal parts. To prevent the projector from possible damage, do not use the projector for at least 2 hours when there is a sudden change in temperature.

Avoid volatile liquids

Do not use volatile liquids, such as insecticide or certain types of cleaner, near the projector. Do not have rubber or plastic products touching the projector for a long time. They will leave marks on the finish. If cleaning with a chemically treated cloth, be sure to follow the cleaning product's safety instructions.

Disposal

This product contains the following materials which are harmful to human bodies and environment.

- Lead, which is contained in solder.

To dispose of the product, consult your local environment authorities for regulations.

- !** The illustrations and the images shown in this document are for your reference. The actual content may vary by the product supplied for your region.

Package contents

Carefully unpack and verify that you have the items below. Some of the items may not be available depending on your region of purchase. Please check with your place of purchase.

Standard accessories

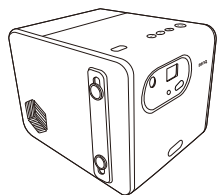

GS50 Projector



ATV Dongle (QS01)

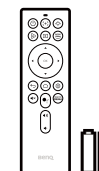

**Remote Control
(with Two AAA Batteries)**

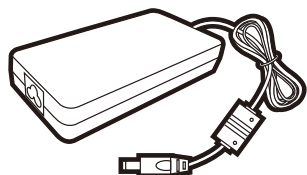

Adapter

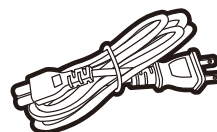

Power Cord

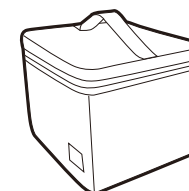

Carrying Bag



Quick Start Guide



**Warranty Card
(varies by region)**



Regulatory Statements

-
-  LED life results will vary depending on environmental conditions and usage. Actual product's features and specifications are subject to change without notice.
 - Some of the accessories may vary from region to region.
 - The warranty card is only supplied in some specific regions. Please consult your dealer for detailed information.
 - For AC/DC adapter, the socket-outlet shall be installed near the equipment and shall be easily accessible.
 - Use original accessories to ensure compatibility.
 - Power cord plug type may change based on regional requirements.
-

Introduction

Projector exterior view

Front, top, and left side view

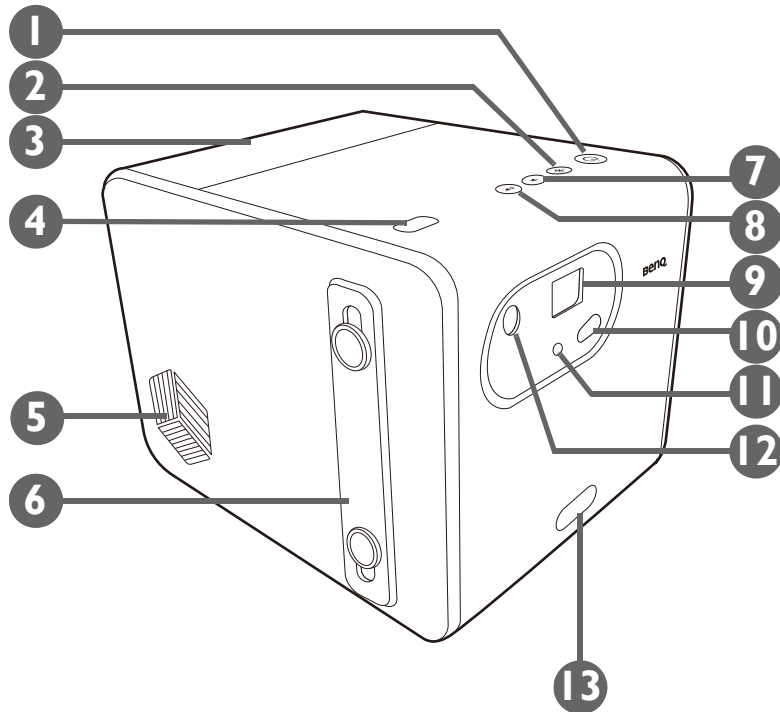

1.  **Power button and LED**

Turns the projector on and off. See [Starting up the projector on page 33](#) for more details. See [LED indicators on page 19](#) for details on the LED behavior.

2.  **Bluetooth button and LED**

Activates Bluetooth speaker mode. See [Using the projector as a Bluetooth speaker on page 53](#) for more details. See [LED indicators on page 19](#) for details on the LED behavior.

3. **Back cover**

Remove to install the ATV dongle (QS01). See [Installing the ATV dongle on page 30](#) for more details.

4. **Ambient light sensor**

5. **Speaker**

6. **Hand strap**

7.  **Volume down button**

8.  **Volume up button**

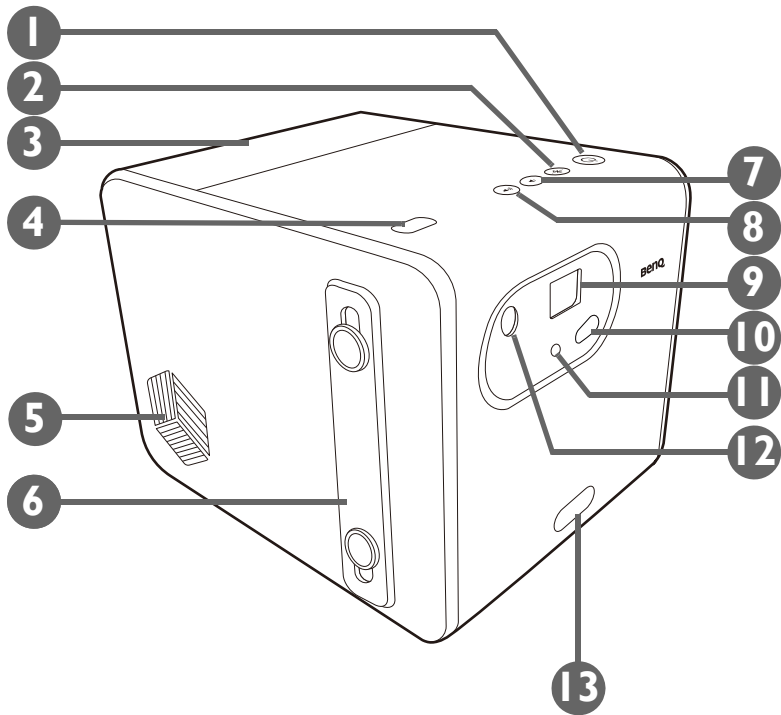

9. Projection lens

10. Front IR sensor

11. Eye protection sensor

Detects objects in front of the projector to automatically shut off the projector light. See [Eye Protection on page 60](#) for details.

12. Auto focus camera

13. Quick-release button

Press to adjust the projection angle. See [Adjusting the projection angle on page 38](#) for more details.

Rear, bottom, and right view

See [Connections on page 46](#) for connection details.

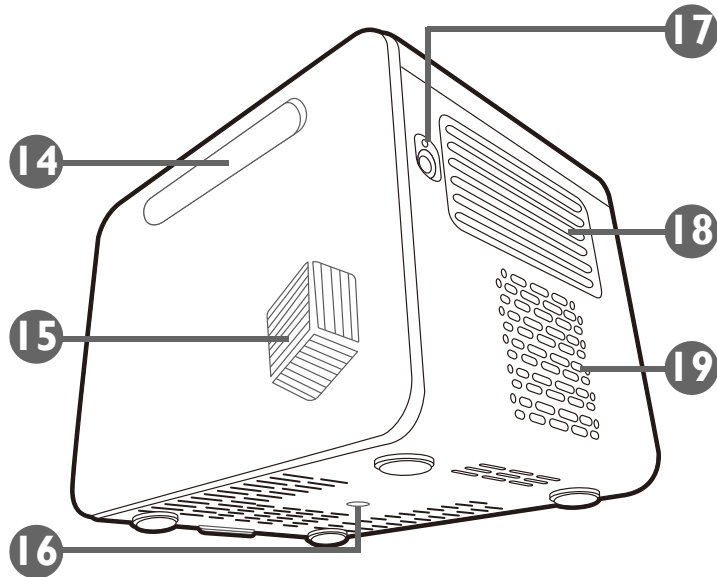

14. IO cover (See [Ports on page 18](#) for details.)

Flip open from the recess on the right side to access the input/output ports.

15. Speaker

16. Tripod screwhole

Used to attach a tripod plate to mount the projector on a tripod. See [Installing the projector on a tripod \(purchased separately\) on page 76](#) for details.

17. Power adapter port

Open the cover to access the port.



Please only use the supplied power adapter to avoid possible dangers such as electric shock and fire.

18. Rear vent

19. Speaker

Dimensions

154 (W) x 146 (H) x 186 (D) mm

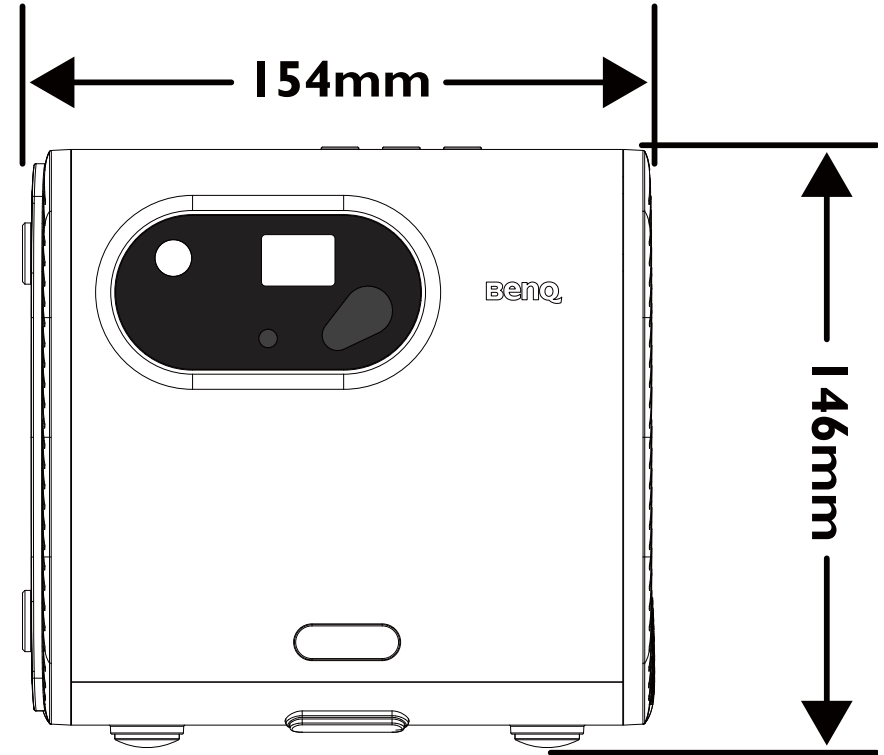
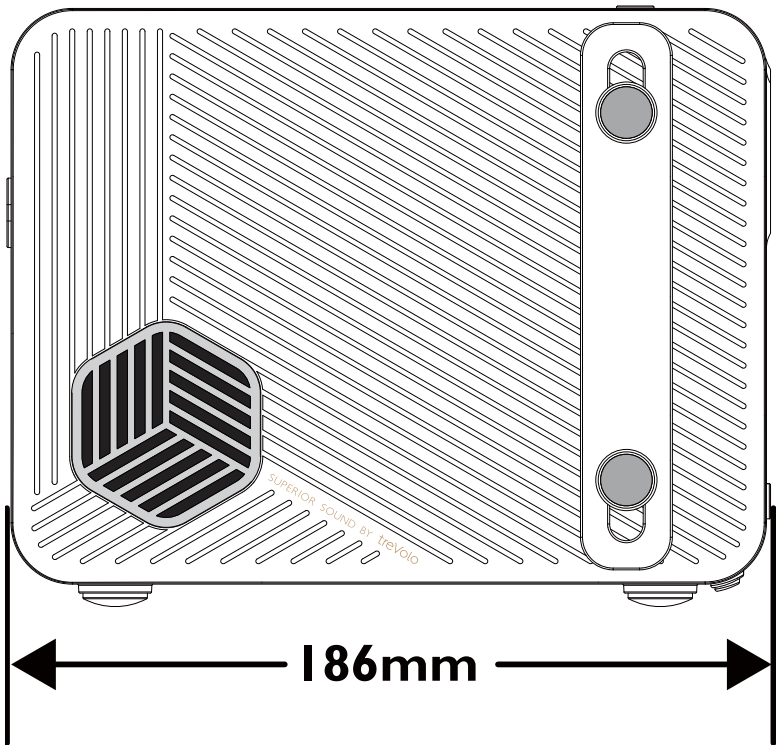

Ports

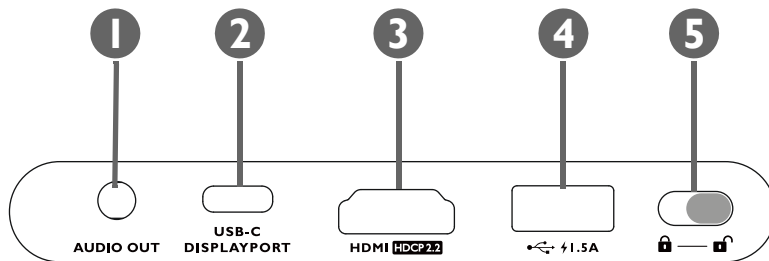

1. 3.5” audio output jack

Used to connect headphones, speakers, and other equipment to broadcast audio.

2. USB-C port with DisplayPort functionality

Used to connect devices with DisplayPort functionality to project video from the device.



The USB-C port is able to provide power (5V, 1.5A) to connected devices. However, it cannot support multimedia reader (i.e., it cannot access files stored on a flash storage drive).

3. HDMI port (Version 2.0b) featuring ARC

Used to connect video sources that support the HDMI interface or speakers that support Audio Return Channel (ARC) to output audio.

4. USB-A 2.0 port

Used to connect a USB-A storage device to project/broadcast media stored on the device.



The USB-A port is able to provide power (5V, 1.5A) to connected devices.

5. Panel key lock

Enables/Disables the buttons on the projector and remote control. When the panel key lock is enabled only the following buttons can be used: the power button on the projector and/or remote control, and the **FamiLand**, **Google Assistant** and **Prime Video** buttons on the remote control.

LED indicators

There is a multi-color power LED (1) and a blue/red Bluetooth LED (2) at the top of the projector.

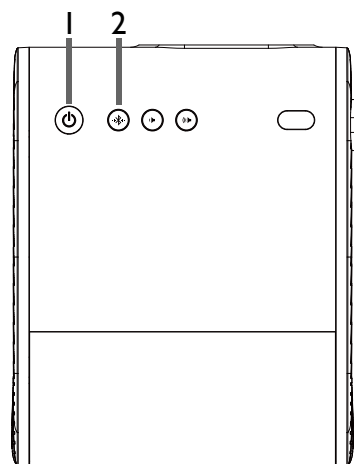

Refer to the table below for definitions of various LED behaviors.

Scenario	Status	Power LED indicator	Bluetooth LED indicator
		LED Behavior	LED Behavior
Turning on / Turning off	Powering on / off properly	Green - breathing	N/A
	Low battery capacity (< 5%)	Red - flashing until stop pressing power button on device	N/A
Charging with Adapter	Battery capacity = 0 ~ 94%	Red - solid	N/A
	Battery capacity = 95 ~ 100%	Green - solid	N/A

Scenario		Status	Power LED indicator	Bluetooth LED indicator
			LED Behavior	LED Behavior
Battery Mode	Power on	Battery capacity = 60 ~ 100%	Green - solid	N/A
		Battery capacity = 20 - 60%	Orange - solid	N/A
		Battery capacity < 20%	Red - breathing	N/A
	Standby	Battery capacity = 60 ~ 100%	Green - breathing	N/A
		Battery capacity = 20 - 60%	Orange - breathing	N/A
		Battery capacity < 20%	Red - breathing	N/A
Battery percentage check (by double-clicking the Power button)		Battery capacity = 60 ~ 100%	Green - flashing twice	N/A
		Battery capacity = 20 - 60%	Orange - flashing twice	N/A
		Battery capacity < 20%	Red - flashing twice	N/A
Bluetooth Speaker Mode		Switching to Bluetooth speaker mode	Refer to charging or battery mode behavior.	Blue - flashing
		Pairing and connecting in process	Refer to charging or battery mode behavior.	Blue - breathing
		Connected successfully	Refer to charging or battery mode behavior.	Blue - flashing twice then turned solid
		Playing music	Refer to charging or battery mode behavior.	Blue - solid
		Disconnecting and entering into Bluetooth standby mode	Refer to charging or battery mode behavior.	Blue - solid then turned breathing
		Switching to Projector mode	Refer to charging or battery mode behavior.	Blue - breathing then turned off

Scenario	Status	Power LED indicator	Bluetooth LED indicator
		LED Behavior	LED Behavior
Error*	Driver board error	Purple - solid	Red- flashing
	Fan error	Red - solid	Red - flashing
	Optical engine temperature error	Red - flashing	Red - solid
	Battery error	Purple - flashing	Red - solid
	G sensor error	N/A	N/A

*Restart the projector if there are any errors.

Remote control

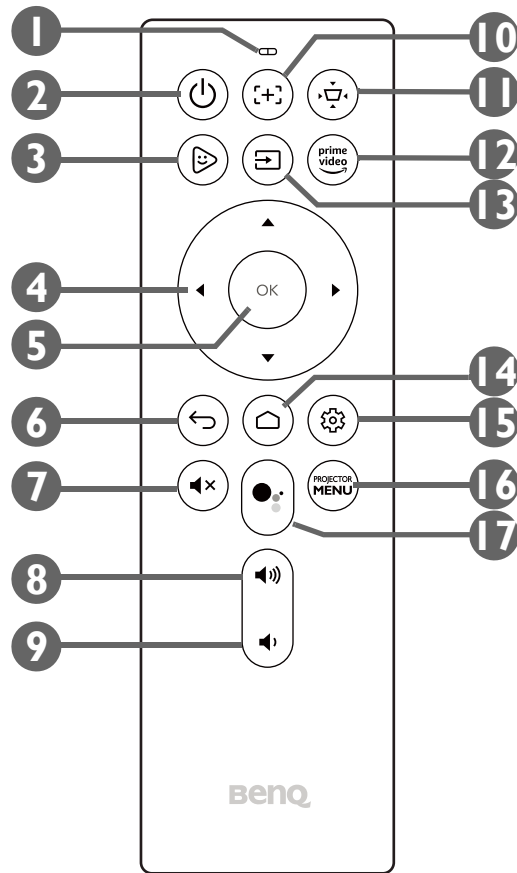

- 1. Microphone**
Receives spoken commands for Google Assistant.
- 2. Power**
Turns the projector off and on.
- 3. FamiLand**
Launches the **FamiLand** app in **Android TV**.
- 4. Arrow buttons (◀Left, ▶Right, ▲Up, ▼Down)**
Used as navigation buttons to select the desired menu items and to make adjustments.
- 5. OK**
Used to confirm selections.
- 6. Back**
Returns to the previous menu.
- 7. Mute**
Mutes the projector's audio.
- 8. Volume Up**
Increases the projector volume.
- 9. Volume Down**
Decreases the projector volume.

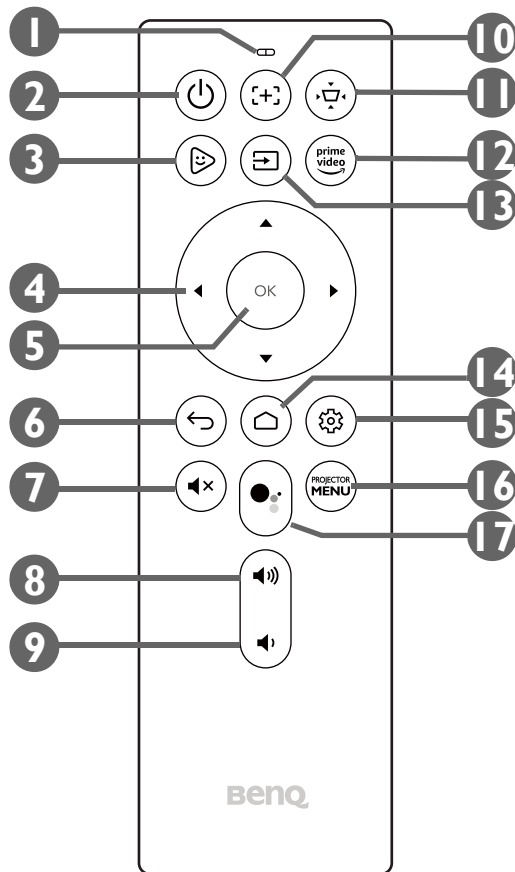

10. [Focus] Focus

Adjusts the focus for the projector automatically. See [Fine-tuning the image clarity on page 39](#) for more details.

11. [Keystone / Corner Fit] Keystone / Corner Fit

Adjusts the keystone settings for the projector. You may switch this button to adjust the keystone or corner fit settings.

See [Correcting keystone on page 40](#) and [Installation on page 61](#) for more details.

12. Prime Video

Launches Amazon's Prime Video streaming service.

13. [Source] Source

Opens the input source menu.

14. [Home] Home

Returns to the **Android TV** home menu.

15. [Settings] Settings

Launches the **Android TV** settings menu.

16. PROJECTOR MENU

Launches the projector's on-screen settings menu.

17. [Google Assistant] Google Assistant

Activates Google Assistant, Google's voice powered virtual assistant service. For more information on Google Assistant, including supported commands and phrases, check Google's official website.

Installing/Replacing the remote control batteries

Before you can begin to use the remote control, you must install the supplied batteries into the remote control.

1. Slide the battery cover outwards.

 When sliding the battery cover, do not try to pull the cover too hard as it is tethered to the remote control by a plastic band and cannot be completely removed.

2. Insert the batteries in the orientation shown below.
3. Slide the battery cover back onto the remote control.

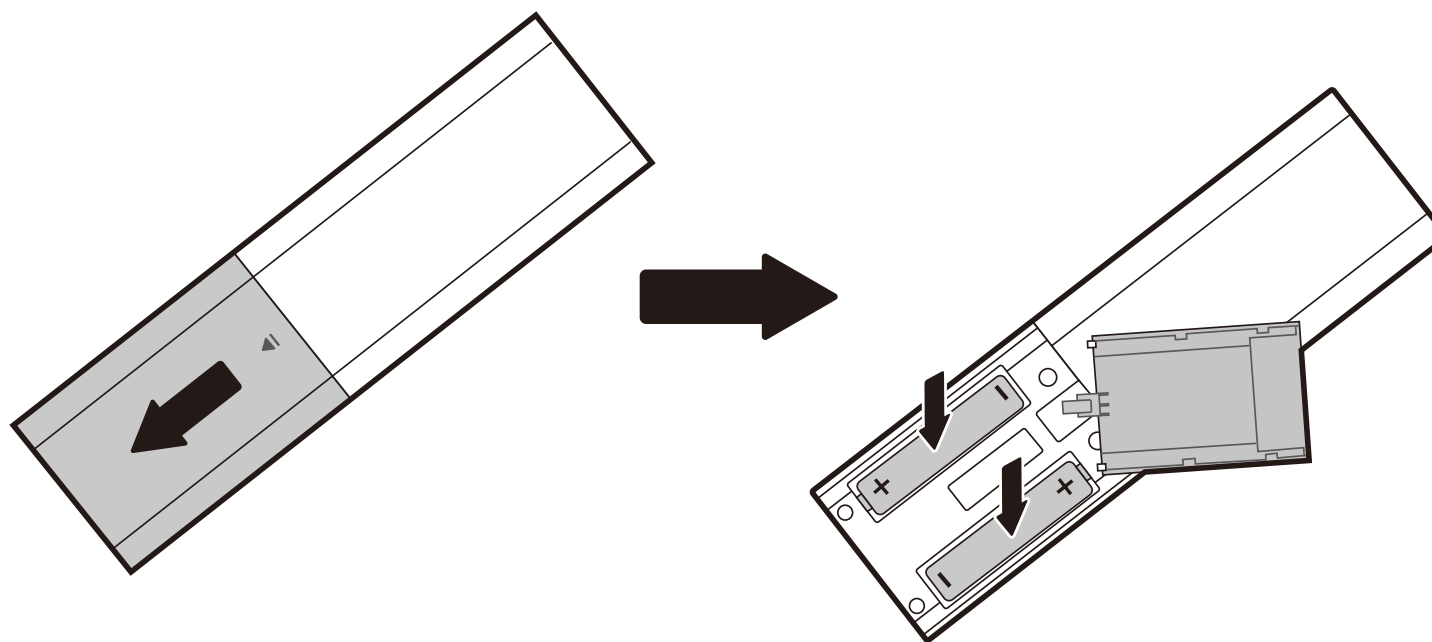

 Avoid leaving the remote control and battery in an excessively hot or humid environment like the kitchen, bathroom, sauna, sunroom or in a closed car.

Remote control effective range

The projector has one IR remote control sensor located at the front of the projector with a range of 8 meters (~26 feet) at an angle of 30 degrees (left and right) and 20 degrees (up and down). Prior to remote control pairing process during the setup wizard (see for [Starting up the projector on page 33](#) details), the remote control can only be used either by pointing it directly at the IR sensor or by reflecting the IR signal off of a wall/screen, making sure that there are no obstacles between the remote control and the IR sensor on the projector.

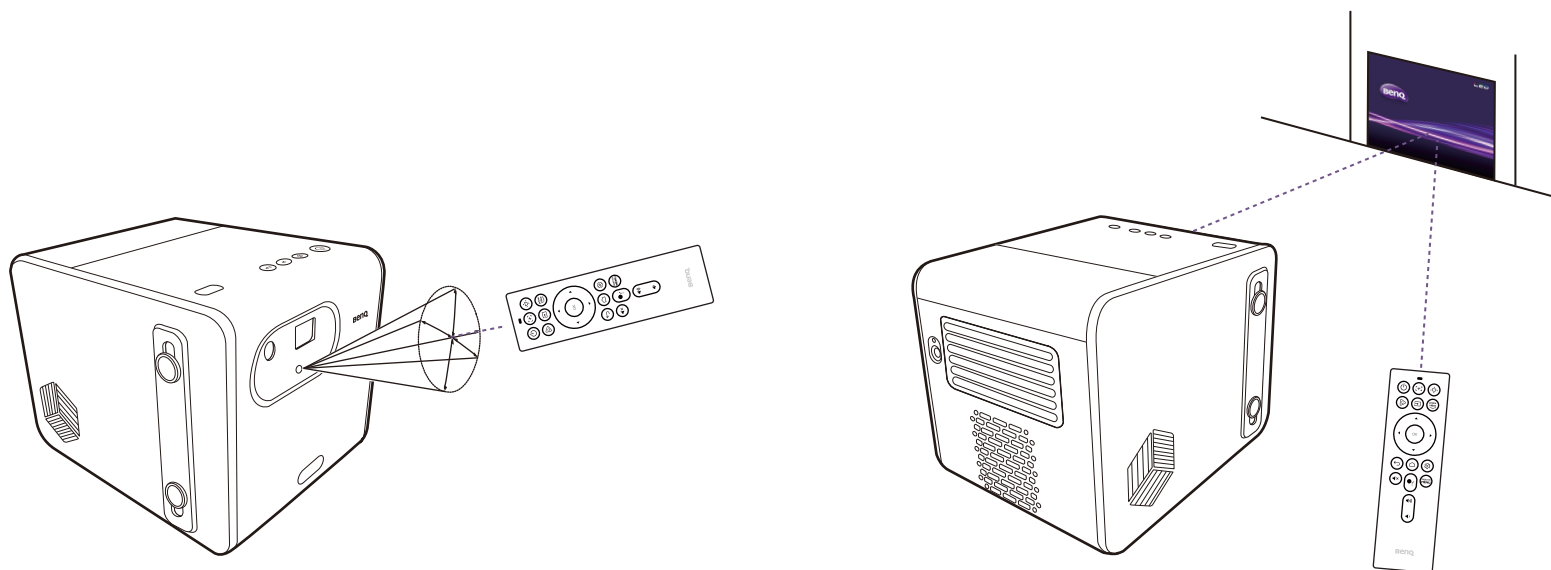

Once the remote control has been paired to the ATV dongle installed in the projector, you will be able to use it at any angle within a range of 7 meters (~23 feet).

 Voice input and Google Assistant functionality on the remote control is only available after the remote control has been paired to the projector during the setup wizard process. See [Starting up the projector on page 33](#) for more details.

BenQ Smart Control (remote control app)

The projector also supports the **BenQ Smart Control** app, which lets you transform your Android or iOS device into a remote control to control the ATV dongle (QS01) via buttons and/or touch gestures.

To begin using the **BenQ Smart Control** app:

1. Download and install **BenQ Smart Control** from Google Play or the iOS App Store on your device (e.g., a smartphone).
2. Connect your smartphone to the same wireless network as the ATV dongle (QS01).
3. Launch the **Wireless Projection** app from the **Android TV** Home screen on the projector to activate the **BenQ Smart Control** function automatically.
4. Open the **BenQ Smart Control** app  on your smartphone.
5. The app will automatically connect to your ATV dongle (QS01).

-
- You must be connected to the same wireless network as the projector for **BenQ Smart Control** to work correctly.
 - If the app does not automatically connect to your ATV dongle (QS01), or if multiple compatible products are connected to the same network, select the corresponding ATV dongle (QS01) you want to control from the list of products.
-

6. Choose one of the following methods to use **BenQ Smart Control**:
 - Tap **DPad** to use the pre-configured buttons in the app to control your projector.

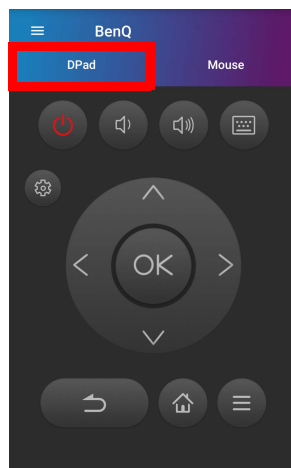

- Tap **Mouse** to use touch gestures on your smartphone to control the cursor on the projector similar to a mouse.

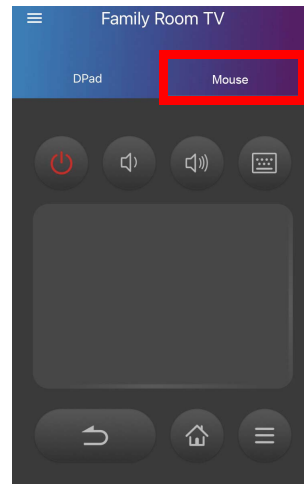



Installation



Choosing a location

Before choosing an installation location for your projector, take the following factors into consideration:

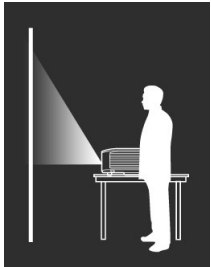
- Size and position of your screen
- Electrical outlet location
- Location and distance between the projector and the rest of your equipment
- Location and distance between the projector and the wireless access point

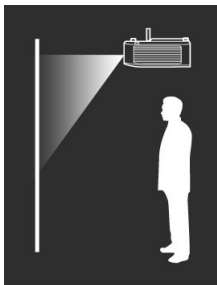
You can install your projector in the following ways:

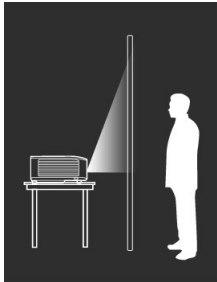
<p>1. Front Table:</p> <p>Select this location with the projector placed near the floor in front of the screen.</p> <p>This is the most common way to position the projector for quick setup and portability.</p> <p>Turn on the projector and select the following settings in the projector's settings menu. See for Installation on page 61 more details:</p> <p>Installation > Projector Position > Front Table</p>	 A silhouette of a person sitting at a table with a projector on the table. A beam of light from the projector is directed towards a vertical screen on the left.
<p>2. Front Ceiling:</p> <p>Select this location with the projector elevated near the ceiling in front of the screen.</p> <p>Turn on the projector and select the following settings in the projector's settings menu. See for Installation on page 61 more details:</p> <p>Installation > Projector Position > Front Ceiling</p> <p> The projector does not feature ceiling mount components/equipment so when choosing to use a front ceiling location you must place it on an elevated location of your choice.</p>	 A silhouette of a person standing with a projector mounted on the ceiling. A beam of light from the projector is directed towards a vertical screen on the left.

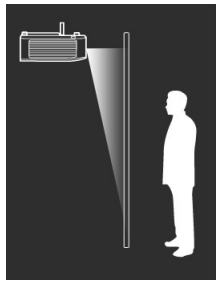
<p>3. Rear Table:</p> <p>Select this location with the projector placed near the floor behind the screen.</p> <p>Turn on the projector and select the following settings in the projector's settings menu. See for Installation on page 61 more details:</p> <p>Installation > Projector Position > Rear Table</p> <p> A special rear projection screen is required.</p>	
<p>4. Rear Ceiling:</p> <p>Select this location with the projector elevated from the ceiling behind the screen.</p> <p>Turn on the projector and select the following settings in the projector's settings menu. See for Installation on page 61 more details:</p> <p>Installation > Projector Position > Rear Ceiling</p> <p> A special rear projection screen is required.</p> <p> The projector does not feature ceiling mount components/equipment so when choosing to use a rear ceiling location you must place it on an elevated location of your choice.</p>	

Using the projector in an outdoor setting

The projector's portable and splash-proof design allows it to support outdoor use. When using the projector outdoors, the following items are suggested to enhance the viewing experience:

- Install the projector on a tripod. See [Installing the projector on a tripod \(purchased separately\) on page 76](#) for more details.
- Set the picture mode to the most suitable setting (e.g. **Camp Fire**, **Day Time**, etc.) for the environment. See [Picture Mode on page 58](#) for more details.
- Disable **Ambient Light Sensor** in the **Eye Protection** settings menu. See [Eye Protection on page 60](#) for more details.

Operations

Installing the ATV dongle

1. Remove the cap from the provided ATV dongle.
2. Remove the back cover from the top of the projector.

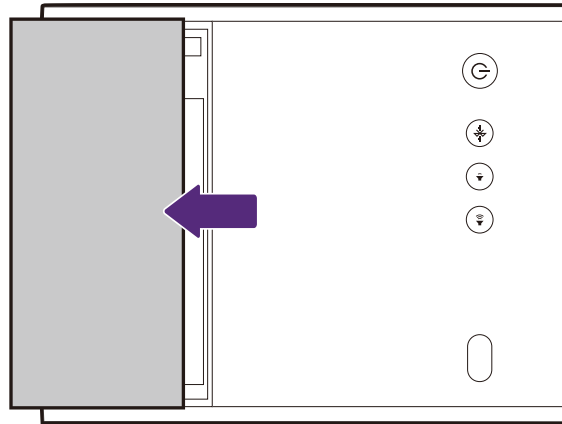

3. Connect the power cable to the port on the side of the dongle and then insert the dongle into the ATV dongle port so that the logo side is facing up.

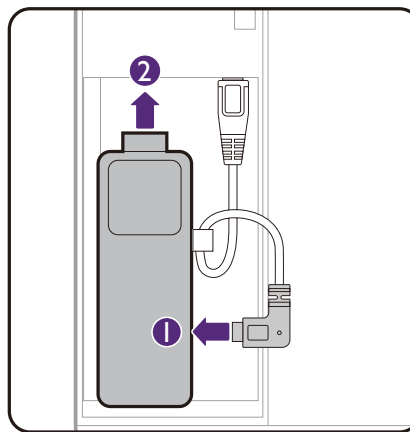

4. Re-install the back cover onto the projector.

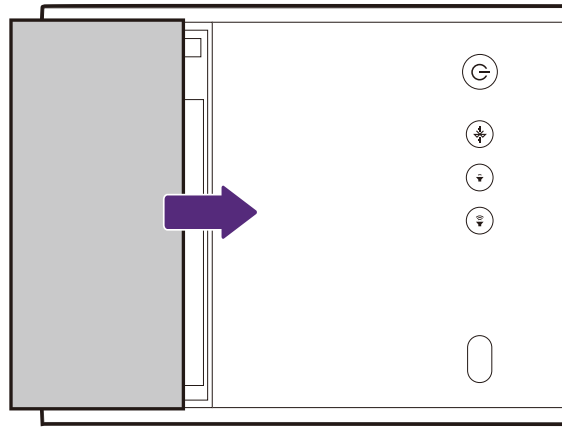

Charging the battery

1. Connect the adapter to the power adapter port.
2. Connect the power cord to the power adapter.
3. Connect the power cord to a power outlet.

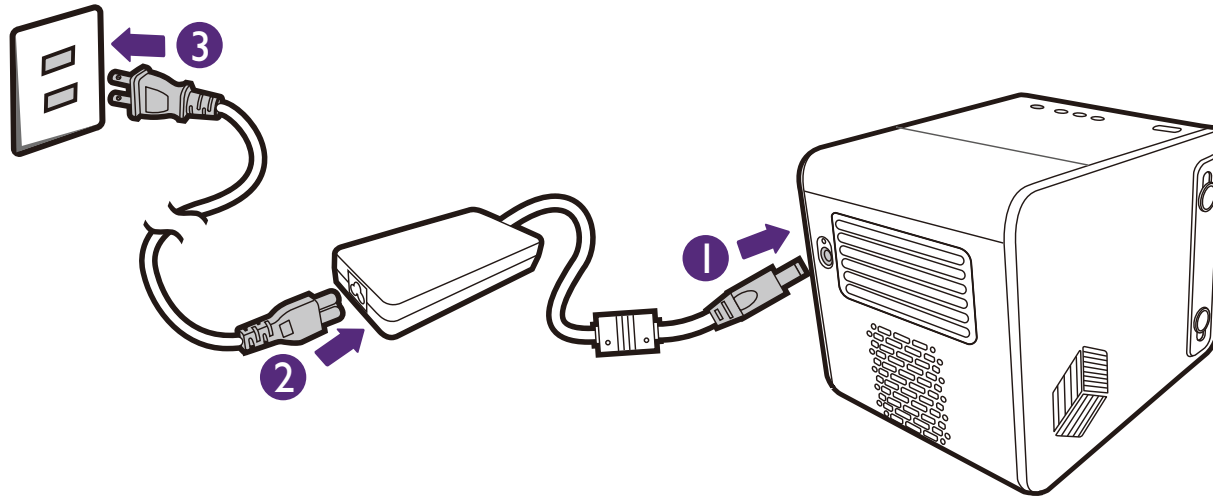

- The projector also supports charging via a power bank with voltage of 19V, 4.73A.
- When charged, the projector is able to supply power via both its USB-C (5V, 1.5A) and USB-A (5V, 1.5A) ports.

The power LED indicator will illuminate according to its charge status, for a full charge wait until the indicator lights up solid green (see [LED indicators on page 19](#) for more information on LED behavior).

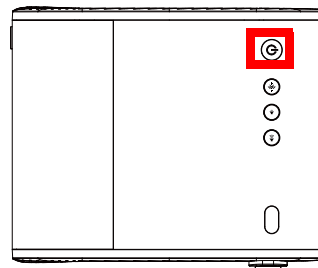

Starting up the projector

! If you are starting up the projector for the first time, it is suggested that the projector is within range of a wireless access point (e.g. a router) with a stable Internet connection as some optional steps during the setup process require Internet access.

1. Install the provided ATV dongle into the ATV dongle port. See [Installing the ATV dongle on page 30](#) for details.
2. Charge the battery or supply power to the projector as indicated in [Charging the battery on page 32](#).
3. Press the power button  on the projector for 3 seconds or remote control for 1 second. The power LED flash a breathing green pattern.

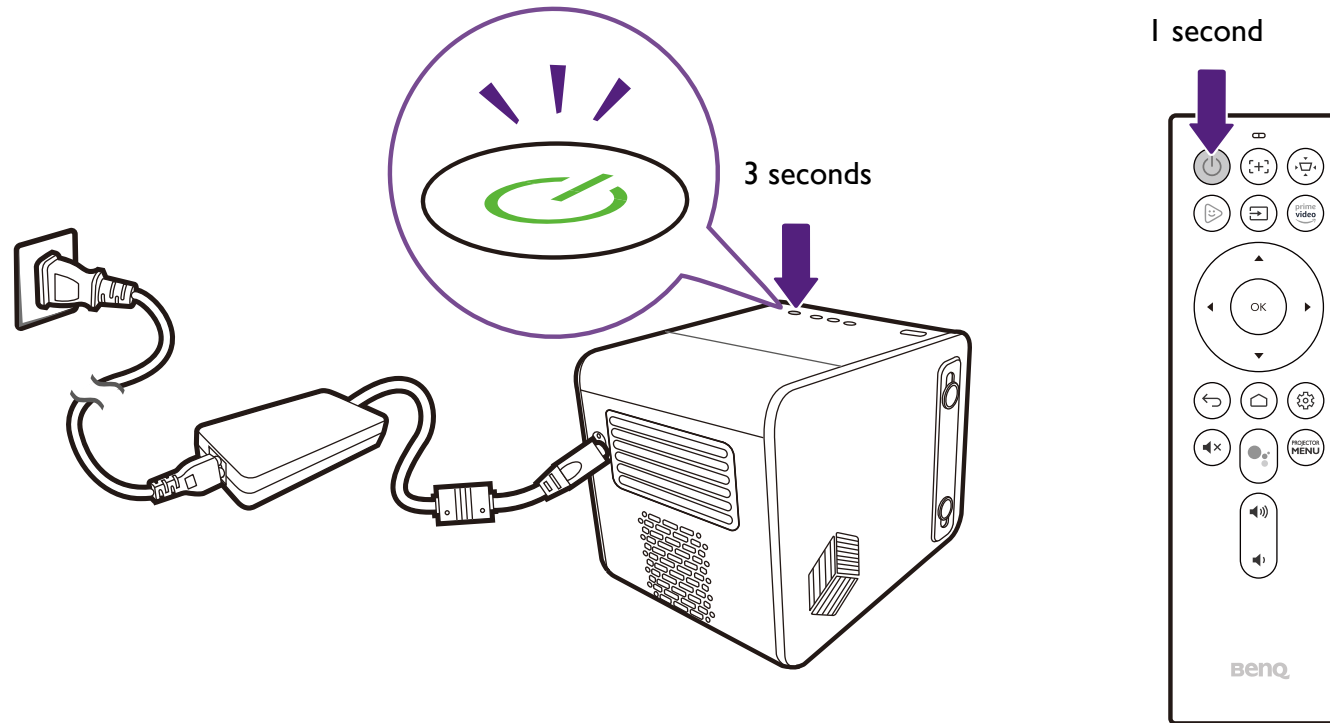

- !**
- When supplying power directly to the projector please use the supplied power cable to avoid possible dangers such as electric shock and fire.
 - Prior to pairing the remote control to your projector you must ensure that your remote control is in range of the projector's IR sensor. See [Remote control effective range on page 25](#) for more details.
 - Powering on via the remote control will not work if you have not completed the setup wizard procedure or if the projector's battery level is below 5%.

4. The fans will start operating and a start-up image will be shown while the projector warms up. This process may take a few minutes. The projector does not respond to further commands while it is warming up.
5. If you are starting up the projector for the first time, the projector's setup wizard will appear to guide you through the initial hardware setup including selecting the projector's positions, system language, and correcting keystone. Using your remote control, follow the on-screen instructions to proceed with the process.

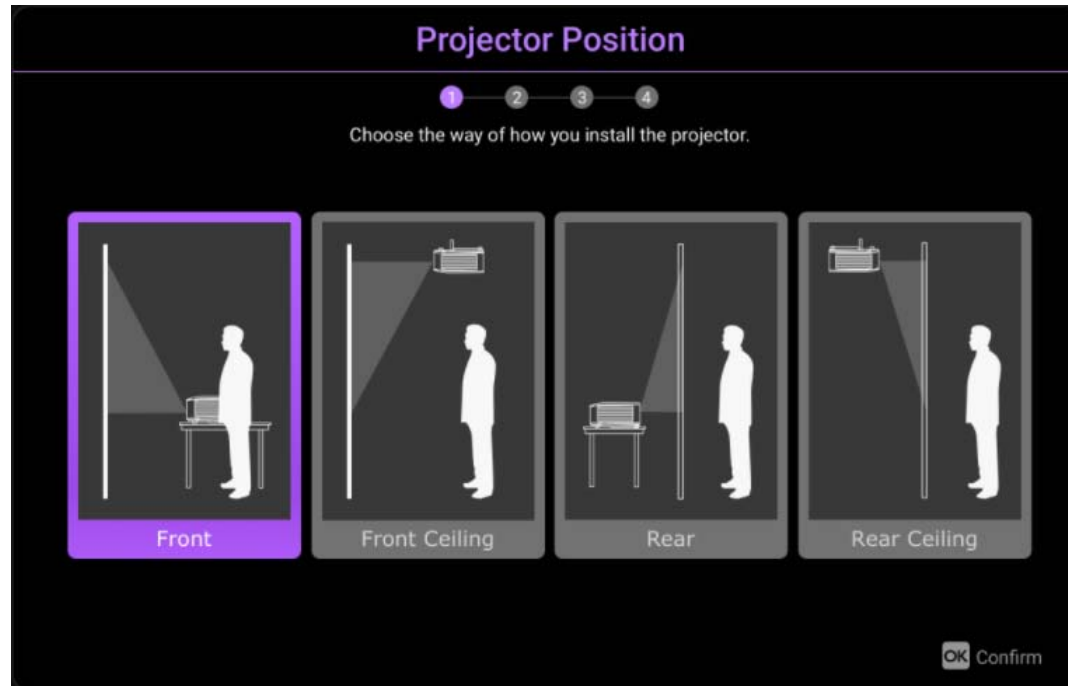

6. Once you've completed the projector's setup wizard, the projector will begin the **Android TV** setup wizard to guide you through setting up the projector's operating system, including steps for pairing the remote control, selecting the language for **Android TV**, setting up a Wi-Fi connection, signing in to a Google account, and others related steps.



- Pairing your remote control to the projector and connecting to a network are required steps in order to proceed with the **Android TV** setup process. You will not be able to use your projector's **Android TV** operating system until you have completed both steps. You will still be able to project via a wired connection if you do not complete the **Android TV** setup process.
- You may proceed with the **Android TV** setup process without signing into a Google account, but you will have limited use of **Android TV**'s services and will be prompted to sign in any time you attempt to use these services.
- To find out how to quickly set up your Google account on the projector, scan one of the QR codes below based on your mobile device's operating system and watch the how-to video.

- **With iOS device**

<https://www.benq.com/en-us/knowledge-center/knowledge/how-to-start-benq-smart-home-projector.html#S1>



- **With Android device**

<https://www.benq.com/en-us/knowledge-center/knowledge/how-to-start-benq-smart-home-projector.html#S2>



7. Once you've completed the **Android TV** setup wizard, the **Android TV** home screen will appear.

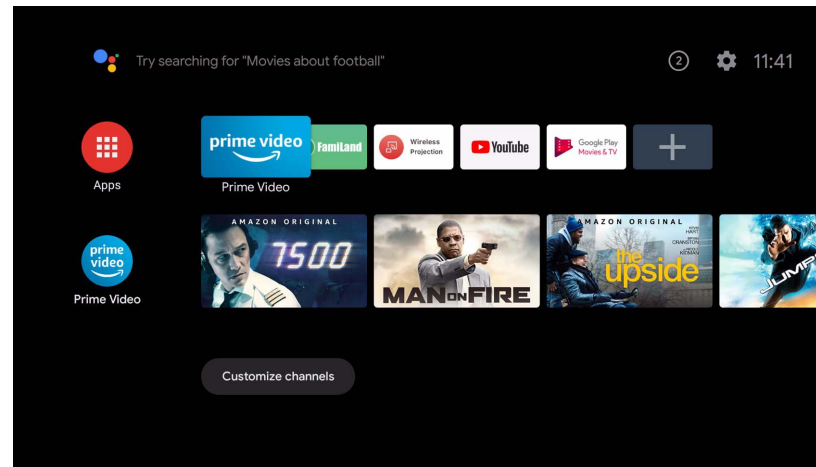

You may enjoy streaming services now. See [Android TV on page 42](#) for more information. Or you may connect a device to the projector to project video. See [Connections on page 46](#) for more information.



The screenshots above are for reference only and may differ from the actual design.

Shutting down the projector

1. Press and hold the power button  on the projector or remote control. The projector will display a shutdown message.
 2. The power LED will flash a breathing green pattern (see [LED indicators on page 19](#)). The fans may continue to run in order to cool the system.
- If the projector will not be used for an extended period, unplug the power cable from the power outlet and remove the batteries from the remote control.

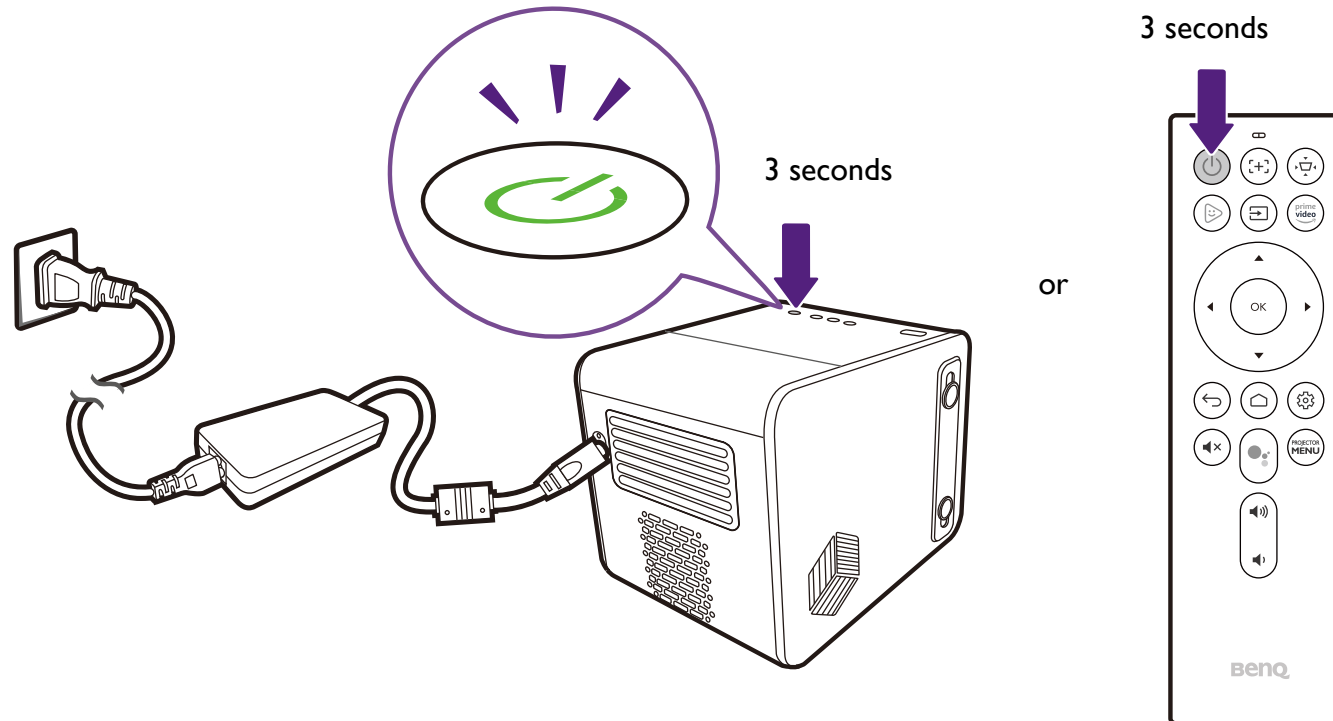

Adjusting the projected image

Adjusting the projection angle

The projector features a quick-release adjuster foot that allows you to adjust the projection angle.

To adjust the projection angle:

- Press the quick-release button and lift the front of the projector. Once the image is positioned as desired, release the quick-release button to lock the foot in position.
- To retract the foot, hold up the projector while pressing the quick release button, then slowly lower the projector.

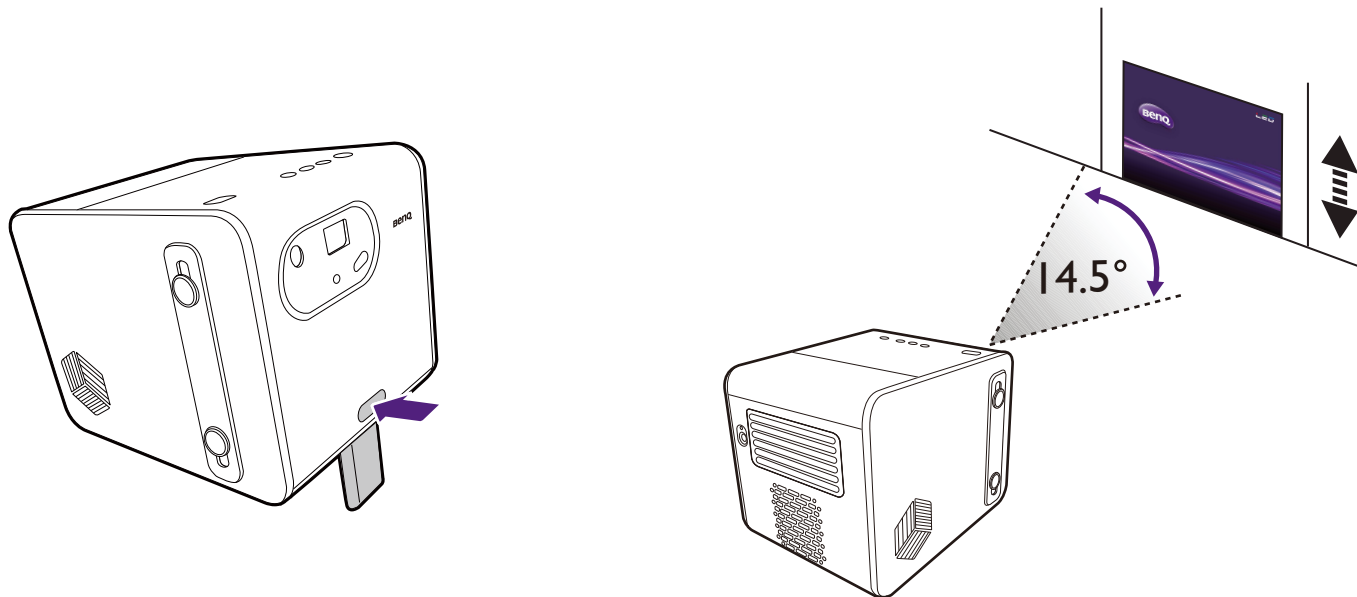

-
-  The maximum angle of adjustment is 14.5 degrees.
 - If the screen and the projector are not perpendicular to each other, the projected image becomes trapezoidal. To correct this, see [Correcting keystone on page 40](#) for details.
-

Fine-tuning the image clarity

To sharpen the picture, press the focus button (F) on the remote control and the projector will automatically focus the image.

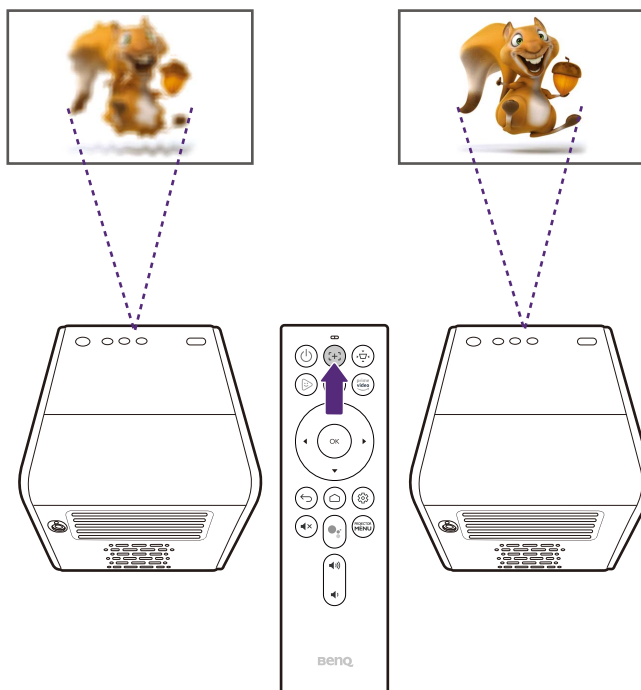



-
- Do not look into the lens while the light is on. The strong light from the light may cause damage to your eyes.
 - You may also allow the projector to automatically focus the image in the settings menu by configuring the **Auto Focus** setting to **Real Time Adjustment** in the settings menu. See [Installation on page 61](#) for more information.
-

Once the projector is finished automatically adjusting the focus, you can also choose to manually adjust the focus by pressing the left ◀ or right ▶ buttons on the remote control while the focus guide is still on the screen.

Correcting keystone

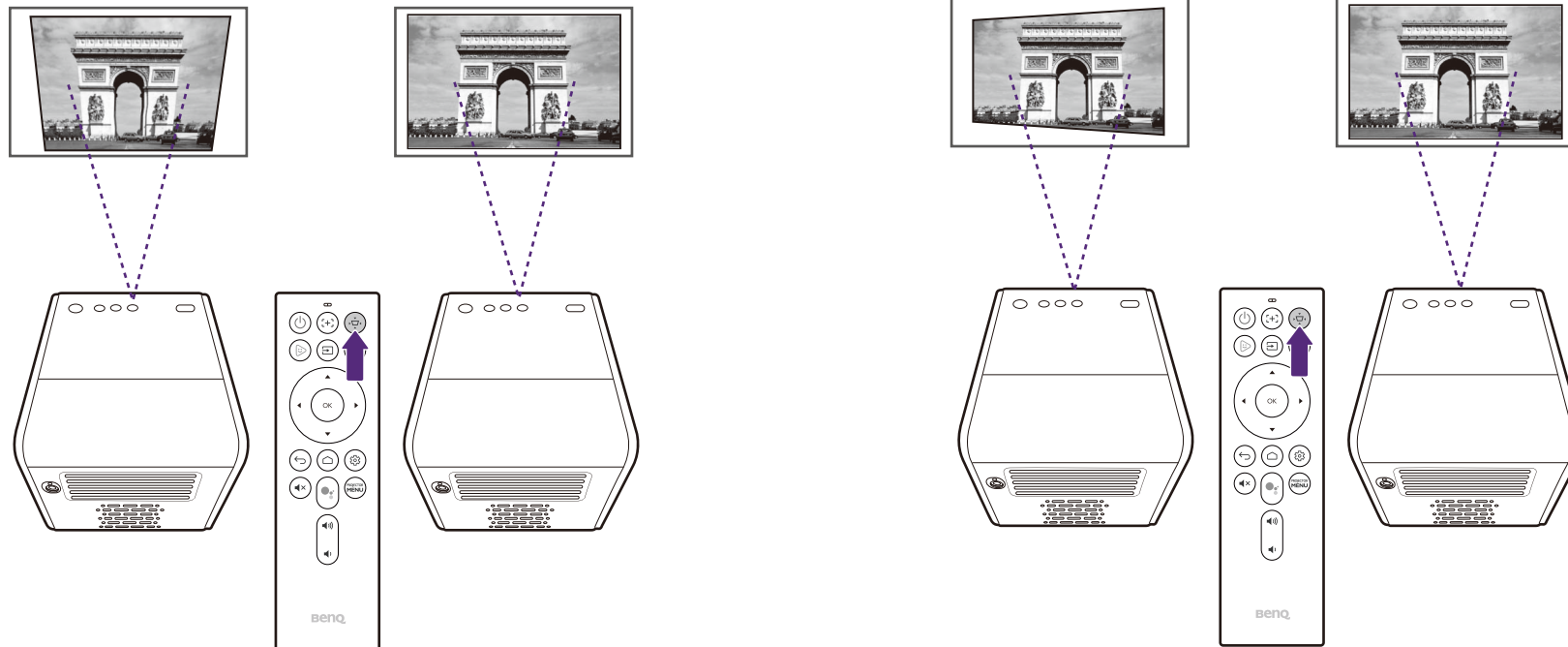
The keystone effect refers to the situation where the projected image is noticeably wider at the top / bottom / left / right. It occurs when the projector is not perpendicular to the screen. To correct the keystone effect press the keystone button  on the remote control and then follow the on-screen instructions to make the adjustments.



When you are done making the adjustments, press  to save your changes and return to the previous menu.

Corner Fit

Corner Fit allows you to correct a situation where the projected image is stretched or distorted along both axes due to the angle of the projection.

To configure the side projection:

1. Press the **PROJECTOR MENU** button on the remote control to enter the projector's settings menu.
2. Select **Installation**.
3. Toggle the **Geometry Correction** setting to **Corner Fit**.
4. Select **Corner Fit Setting**.
5. Choose one of the corners you want to adjust and then follow the on-screen instructions to correct the image.

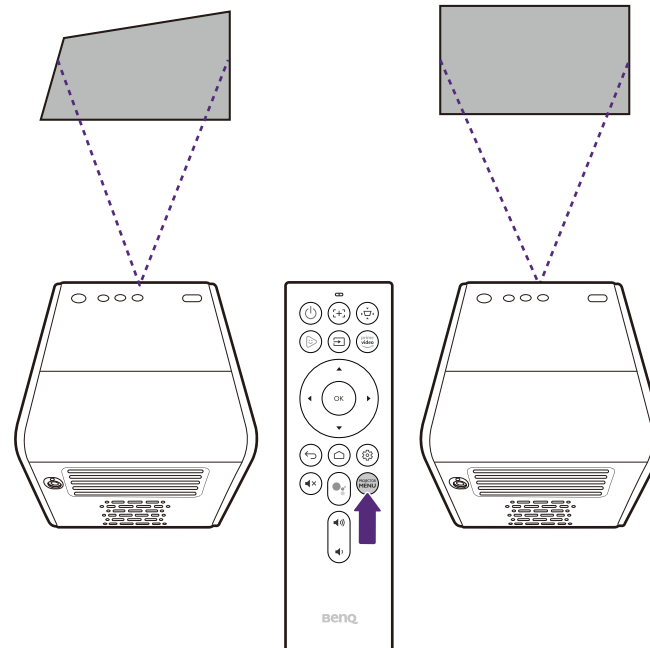

Android TV

Android TV is the projector's operating system that allows you to project videos wirelessly and use streaming apps.

The **Android TV** home screen

Upon initial startup or when the input source is set to **ATV** the projector will display the **Android TV** interface. If the projector is projecting from a source, you can return to **Android TV** by pressing \square on your remote control or by selecting **ATV** in the input source menu.

The **Android TV** home screen features following items:

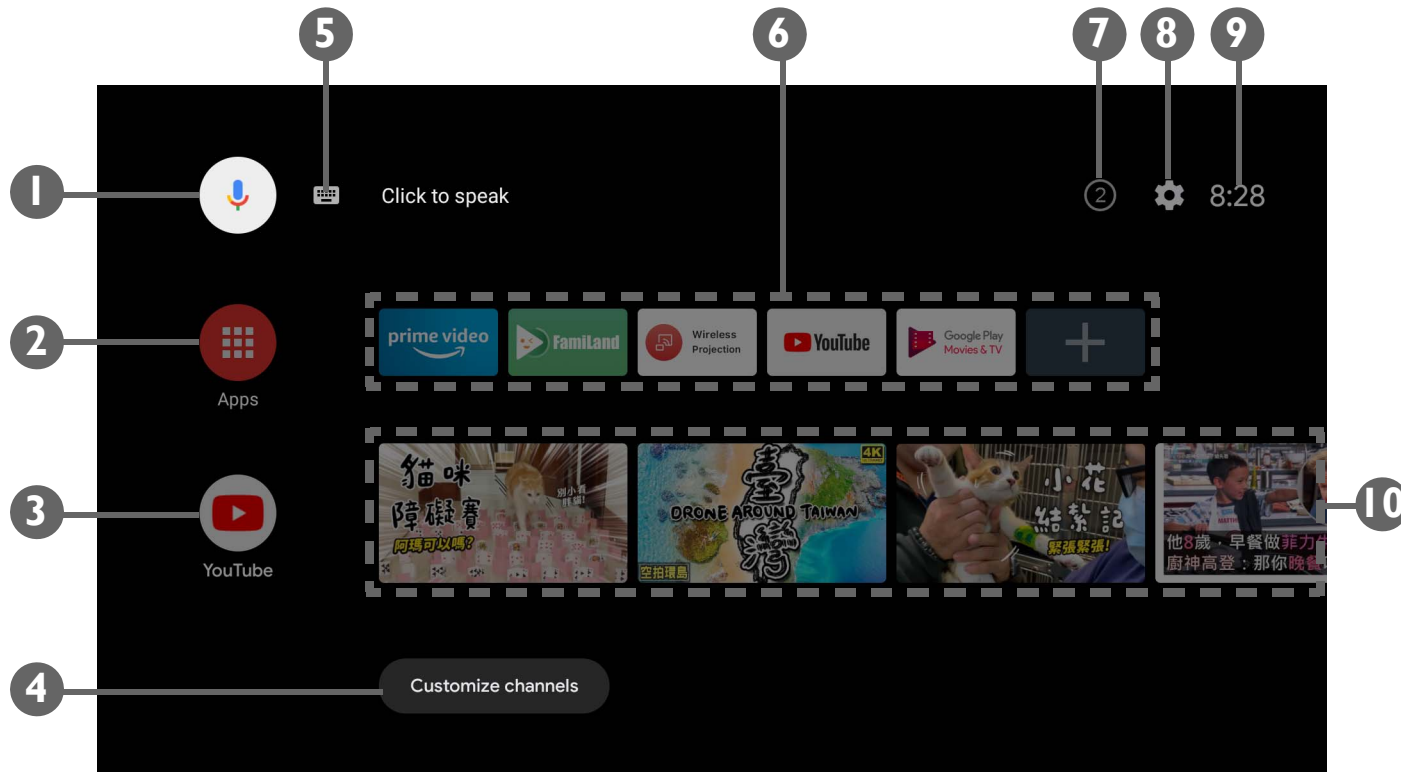

Actual screen may vary based on your **Android TV** version.

No.	Item	Description
1	Google Voice Search / Google Assistant	Enables Google Voice Search / Google Assistant.
2	All apps	Accesses all the installed apps.
3	YouTube	Launches the YouTube app.
4	Customized channels	Allows you to customize app channels that appear on the home screens feed.
5	Search by text	Enables text input to search.
6	Recommended apps or services	Quick access to recommended apps or videos-on-demand services. Select the + button to add app shortcuts to this row.
7	Notifications	Accesses notification(s).
8	Settings	Accesses the Android settings menus.
9	System time	Displays the time.
10	Recommended YouTube videos	Quick access to videos recommended by YouTube.

For more information on Android TV, you can use the following resources:

- For How-to videos on Android TV and FamiLand, scan the QR code below or go to:
<https://www.benq.com/en-us/knowledge-center/knowledge/how-to-start-benq-smart-home-projector.html>.



- For the QS01 ATV dongle user manual, visit [Support.BenQ.com](https://www.benq.com/support).

Google Assistant

Android TV supports Google Assistant, Google's voice powered virtual assistant service, for basic commands and Google searches. To activate Google Assistant press the Google Assistant button  on the remote control and say your command or question into its microphone. For more information on Google Assistant, including supported commands and phrases, check Google's official website.

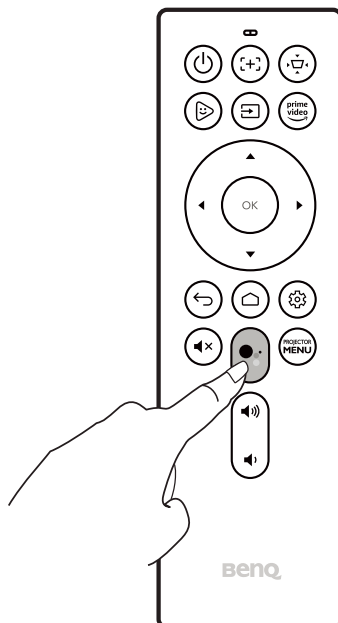

Playing music via the projector

With the built-in speakers, you can enjoy music playback via the projector without a projection screen. The projector can work as an ordinary speaker or a Bluetooth speaker.

Using the built-in speaker on the projector

1. Access a music streaming service or a music channel from **Android TV**
2. Start the music playback.
3. Press the power button  on the projector or remote control to bring up the power menu.
4. Select **Audio-Only Mode**. The screen is turned off while the music playback continues.
5. To stop the playback or to perform other operations, press any key on the remote control to bring the projection screen back.

Using the projector as a Bluetooth speaker

See [Using the projector as a Bluetooth speaker \(page 53\)](#) for details.

Connections

You can connect your device to the projector in various ways to project video content.

Wireless Connection

- Smartphone, tablet, laptop/PC

Wired Connection (HDMI port)

- A/V device.
- Smartphone, tablet, laptop/PC
- Speakers featuring ARC capabilities

Wired Connection (USB-A port)

- USB-A flash drive

Wired Connection (USB-C port)

- Smartphone, tablet, laptop/PC

-
-  • Devices connected via the USB-C port require a USB-C cable and must support DisplayPort (version 1.1 or above) functionality in order to project video.
 - The USB-C port supports USB Power Delivery and is able to provide power/charge devices connected to it (45W, 15V, 3A). However, it cannot support multimedia reader (i.e., it cannot access files stored on a flash storage drive).
-

Furthermore, you can also connect the projector to Bluetooth speakers/headphones to broadcast audio through the speakers/headphones or connect a mobile device to the projector via Bluetooth to broadcast audio through the projector's speakers.

Before making any wireless connections, be sure to:

- Install the provided ATV dongle for wireless connection.
- Place the projector within range of the wireless AP you plan to connect it to.

Before making any wired connections, be sure to:

- Use the correct cables for each source and make sure the cables are firmly inserted.

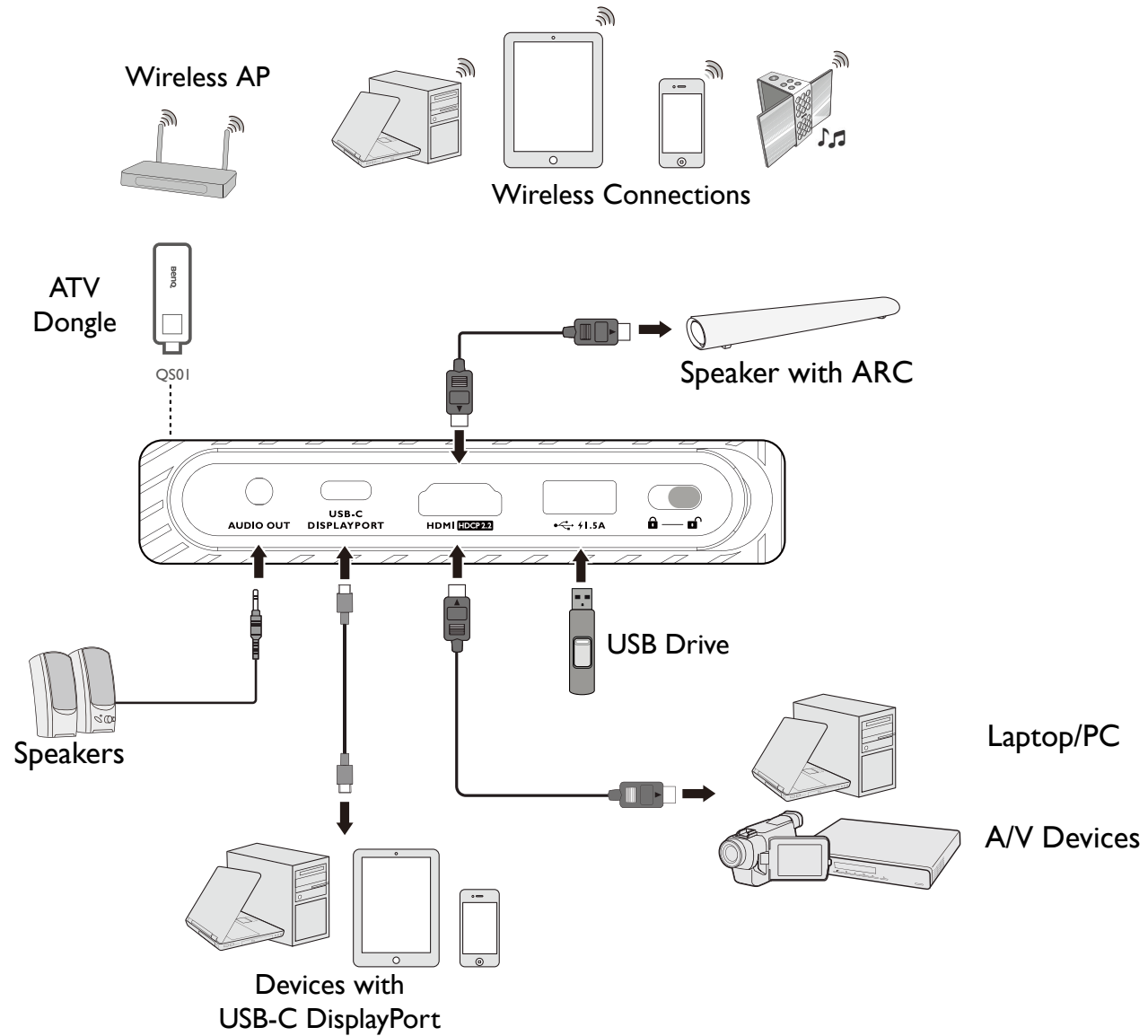

 The illustration above is for reference only.

Switching between **Android TV** and input sources

By default, the projector will enter the **Android TV** interface any time it is powered on. Once powered on, when a device is connected to one of its input ports the projector will automatically switch over to that input source.

To switch between input sources and **Android TV**, press the source button  on the remote control and select the desired input source from the source menu.

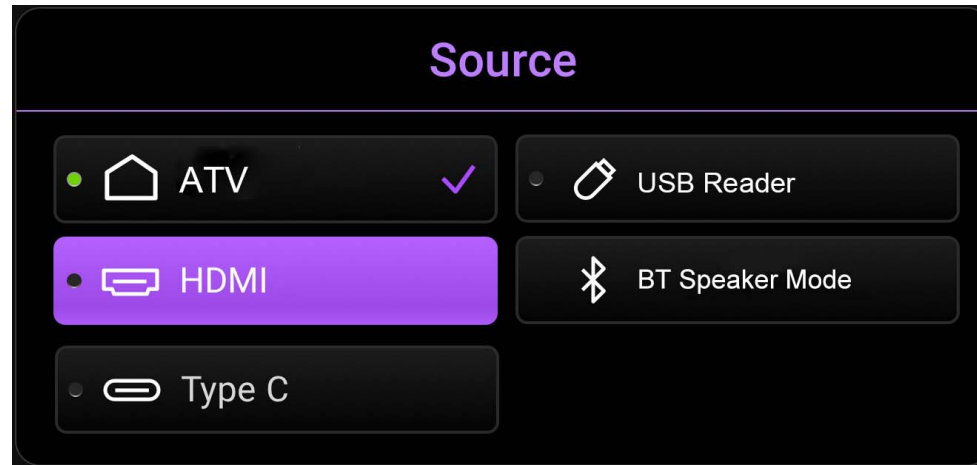

You can also press the home button  on the remote control to return to the **Android TV** home screen at any time.

Wireless connections

Before you can project wirelessly via the projector you must first connect the projector to a wireless network. To connect your projector to a wireless network or to switch wireless networks, use the **Network & Internet** sub-menu in the **Android TV** settings menu.

Wireless projection

To wirelessly connect a device to the projector for the first time, you need to launch the **Wireless Projection** app from the **Android TV** Home screen on the projector to activate the function automatically.

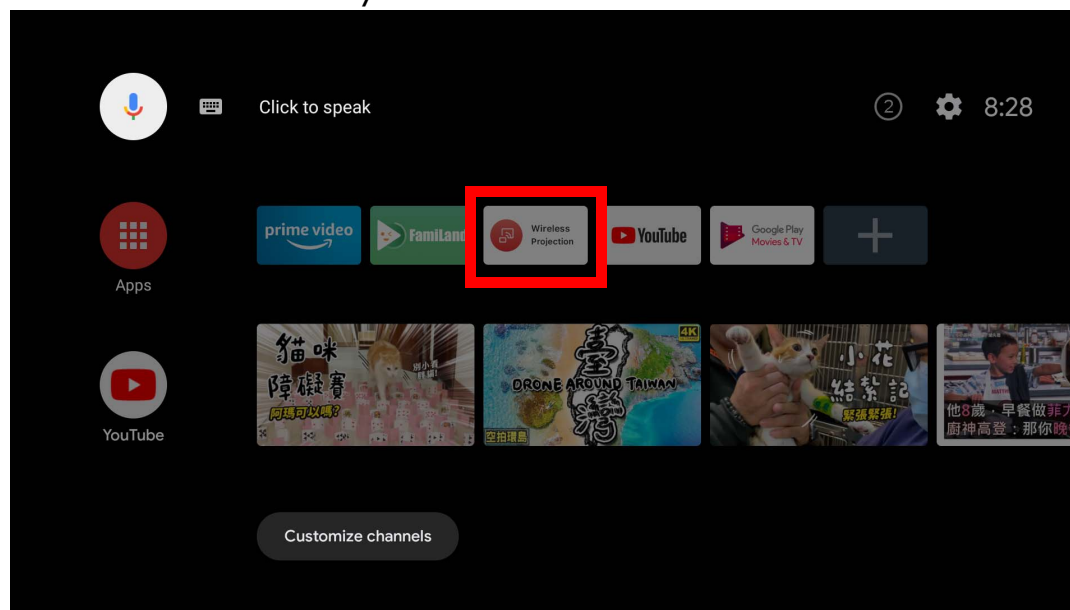

- To download the QS01 user manual, visit [Support.BenQ.com](https://support.benq.com).
- The projector only supports wireless projection via the AirPlay (for iOS devices) or Chromecast built-in (for Android devices). As a result, not all Android devices are able to wirelessly project on the projector. To check if your Android device supports wireless casting via Chromecast built-in, check support.google.com.
- Netflix only supports specific authorized devices and is not natively available on BenQ smart home projectors. Please follow the recommended viewing procedures in [this how-to video](#) to cast your screen from a computer. Visit [Support.BenQ.com](https://support.benq.com) and check out the QS01 product page for details.

Wired connections

Connecting a device with HDMI or USB-C with DisplayPort



Using an HDMI or USB-C Gen3.1 cable you can connect a device that is equipped with HDMI or DisplayPort capabilities to broadcast videos and images on the projector.

 Not all devices with a USB-C port have DisplayPort functionality. Check your device's documentation for clarification. The USB-C port on this projector cannot support multimedia reader (i.e., it cannot access files stored on a flash storage drive).

To connect a device with HDMI or USB-C with DisplayPort:

1. Connect the device to the HDMI or USB-C port on the projector. A pop-up notification will appear indicating that a device is connected.
2. Confirm whether you want to project video from the device. The video from the device will be displayed once the signal from the device is detected.

 If no signal is detected or the signal is interrupted a message will appear.

3. Use the source menu or press the home button  to exit and go back to the **Android TV** home screen.
4. If the device remains connected and you want to project its video again press the source button , and then select the corresponding port in the source menu.



- Some computers feature HDMI ports that do not transmit audio, in such cases a separate audio cable must be connected to the projector.
- Some laptops do not turn on their external video ports when connected to a projector. Usually a key combination like **Fn + F3** or CRT/LCD key turns the external display on/off. Locate a function key labeled CRT/LCD or a function key with a monitor symbol on the laptop. Press **Fn** and the labeled function key simultaneously. Refer to your laptop's documentation to discover your laptop's key combination.

Connecting a speaker with ARC

The HDMI port on the projector features Audio Return Channel (ARC) capabilities which allows it to output its audio to an ARC-compatible speaker connected via an HDMI cable.

Connecting a flash drive

Connect a USB-A drive to the respective port on the projector to play media files stored on the flash drive.

To play media files stored on a flash drive:

1. Connect the flash drive to the USB-A. A pop-up notification will appear indicating that a storage device is connected.
2. Confirm whether you want to play media files from the device.
3. Select the storage device where the media files are located.

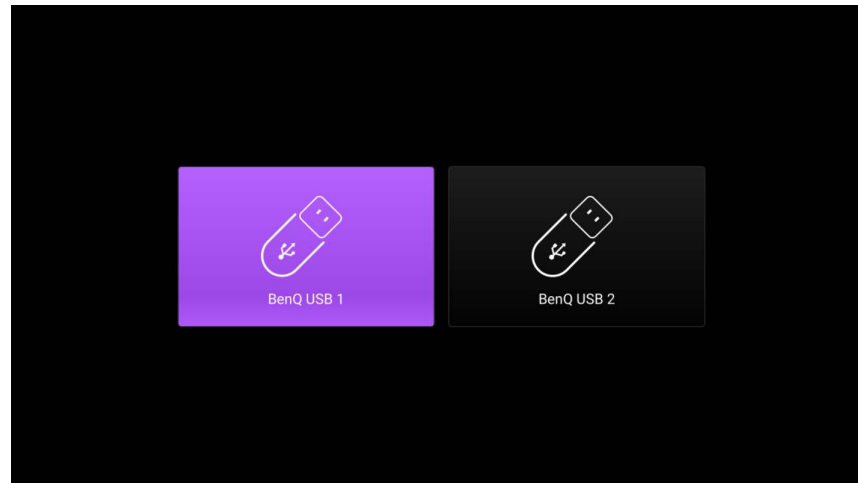

4. Select the type of media file you want to play or select **All** to view all files located on the device.

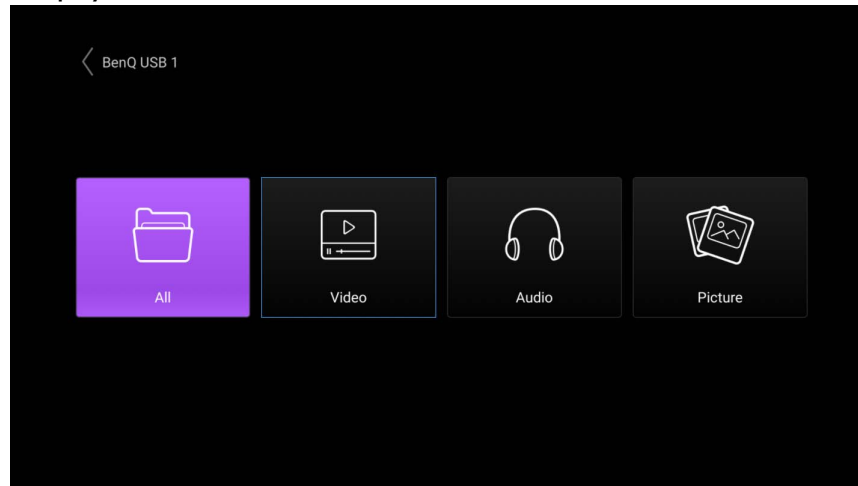

5. Navigate to and select the media file you want play. The projector's media player will launch.

Bluetooth connections



The projector allows the following types of Bluetooth connections:

- Connect a mobile device to the projector to broadcast audio through the projector's speakers.
- Connect to a Bluetooth-enabled speaker or headphones to output audio directly for greater sound.

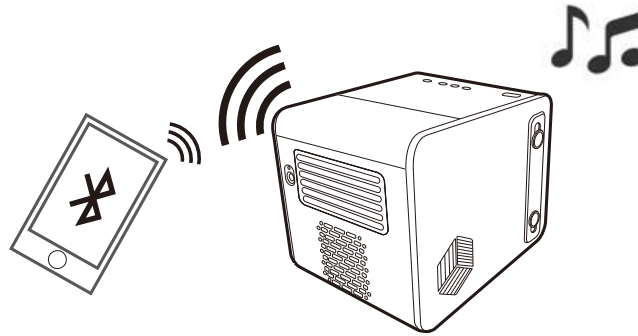
Using the projector as a Bluetooth speaker



1. Make sure the ATV dongle is installed properly (see [Installing the ATV dongle on page 30](#)).
2. Power on the projector (see [Starting up the projector on page 33](#)).
3. Press the Bluetooth button  on the top side of the projector. The projector will stop projecting and switch over to Bluetooth speaker mode.

 You may also enable Bluetooth speaker mode by pressing the source button  on the remote control and selecting **Bluetooth Speaker Mode**.



4. Pair your external device to the projector.

After you have successfully paired your mobile device with the projector, pairing information will be stored on both devices and a connection will automatically be made when Bluetooth is enabled on both devices and both devices are within range of each other.

 If you are unable to activate Bluetooth mode or if the Bluetooth LED does not illuminate, shut off the projector and check to see if the ATV dongle is properly installed. See [Installing the ATV dongle on page 30](#) for details.

Ending the Bluetooth connection

In cases where you want to disconnect the mobile device from the projector, either:

- Disconnect from the projector in the Bluetooth menu of your mobile device.
- Press the Bluetooth button  on the projector to return the projector to projector mode.
- Press and hold the power button  on the projector or remote control to power off the projector.

Pairing/Connecting to a Bluetooth speaker or headphones

1. Make sure the ATV dongle is installed properly (see [Installing the ATV dongle on page 30](#)).
2. Power on the projector (see [Starting up the projector on page 33](#)).
3. Press the settings button  on the remote control
4. Select **Remotes & Accessories**.
5. Select **Add accessory**.
6. Activate Bluetooth-pairing mode on the speaker or headphones.
7. Select the speaker or headphones from the device list shown on screen.
8. Select **Pair**.

When the projector and speaker or headphones have successfully connected, the device will be labelled as **Connected** in the **Network & Internet**. You can now output the audio from the ATV to the speaker or headphone.

-
-  • The projector can only transmit audio from ATV via Bluetooth connection. Even when the projector is switched to other input sources, such as HDMI, as ATV is still running in the background, it will continue to transmit audio from ATV to the connected Bluetooth speaker or headphones.
 - The projector does not support automatic re-connections with previously paired devices. In order to re-connect to a paired device or connect to another device, repeat the steps above.
-

Disconnecting a Bluetooth speaker or headphones

To disconnect a Bluetooth speaker or headphone from the projector so that it no longer outputs the projector's audio:

1. Press the settings button  on the remote control
2. Select **Remotes & Accessories**.
3. Select the speaker or headphones you want to disconnect from the device list shown on screen.
4. Select **Unpair**.

Navigating the settings menu

About the settings menu

To let you make various adjustments or settings on the projector, the projector provides a **Settings** menu. To access the menu, either press the **PROJECTOR MENU** button on the remote control or select **All Projector Settings** from the Android TV **Settings** menu.

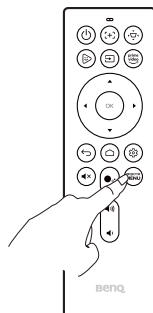

 For settings related to the system including wireless connection, account, and app related setting, use the Android TV **Settings** menu accessible on the home screen. See [The Android TV home screen on page 42](#) for more details.

Under the settings menu there are two subcategories: **Picture & Sounds** and **General**:

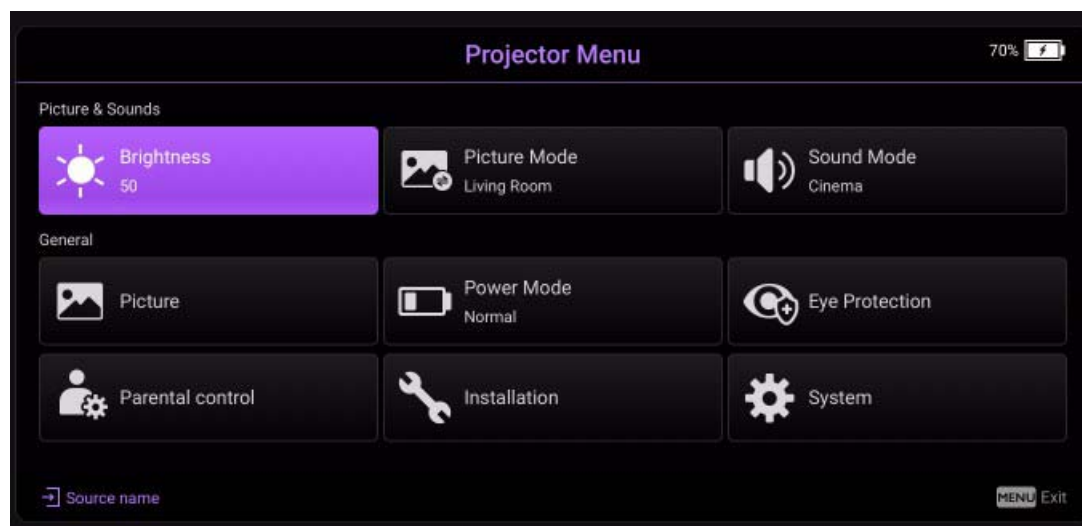

Using the **Settings** menu

To access the various settings menus:

- Use the arrow buttons (▲/▼/◀/▶) to move through the main settings menus.

- Use **OK** to select the desired menu.

When configuring items within a menu:

- Use the up and down arrow buttons (▲/▼) to move to the item you want to configure.

- Use **OK** to select sub-menu options.

- Use the arrow buttons (▲/▼ ◀/▶) to toggle through the available options.

- Use the back button ↶ to return to the main settings menu.

- Use the home button 🏠 to return to the **Android TV** home screen.

Brightness

Allows you to adjust the brightness of the projector on a scale of 0 to 100.

Picture Mode

The following table describes the items available in the **Picture Mode** menu:

Item	Options and descriptions
Bright	Maximizes the brightness of the projected image. This mode is the brightest mode on your projector.
Living Room	With well-saturated colors and fine-tuned sharpness, this mode is slightly brighter than Cinema mode and suitable for playing TV streaming under a small amount of ambient light.
Sports	With well-saturated colors, this mode is best for watching sporting events.
Game	Picture settings appropriate for playing video games. This mode especially enhances details in dark scenes so that enemies cannot hide.
Cinema	With accurate colors and deepest contrast at a lower brightness level, this mode is suitable for playing movies in an environment with a bit of ambient light.
Day Time	By brightening dim regions of images, this mode is suitable for use in lit spaces.
Camp Fire	Being slightly brighter than Cinema mode, it is suitable for playing movies in the outdoors where there is a small amount of ambient light at night.
(HDR10)	Delivers High Dynamic Range effects with higher contrasts of brightness and colors.
(HLG)	Delivers Hybrid Long Gamma effects by adding a logarithmic curve with extra brightness over the top of the signal.

Sound Mode

Sound Mode utilizes sound enhancement technology, which incorporates Waves' algorithms to deliver great effects of the bass and treble and provide you with immersive cinematic audio experience. The available options include: **Standard**, **Cinema**, **Music**, **Game**, and **Sports**.

Picture

The following table describes the items available in the **Picture** menu:

Item	Options and descriptions
Picture Mode	Allows you to switch between picture modes. See Picture Mode on page 58 for more details
Brightness	Allows you to adjust the brightness of the projector on a scale of 0 to 100.
Contrast	The higher the value, the greater the contrast. Use this to set the peak white level after you have previously adjusted the Brightness setting to suit your selected input and viewing environment.
Color	Lower setting produces less saturated colors. If the setting is too high, colors on the image will be overpowering, which makes the image unrealistic.
Sharpness	The higher the value, the sharper the picture becomes.
Color Temperature	There are several preset color temperature settings available. The available settings may vary according to the signal type selected. Options include: Normal , Warm , and Cool .
Reset Picture Setting	Resets all settings in the Picture menu to the factory defaults.

Power Mode

The following table describes the items available in the **Power Mode** menu:

Item	Options and descriptions
Normal	100% LED brightness.
Eco Mode	This setting reduces system noise and power consumption by 30%. If Eco Mode is selected, the light output will be reduced and result in darker projected pictures.
Low Power	Lowers brightness to 50% to extend the LED life.

Eye Protection

The following table describes the items available in the **Eye Protection** menu:

Item	Options and descriptions
Auto Eye Protection	Enables/Disables the automatic shutting off of the projector's light when the eye protection sensor detects an object in front of the projector lens within a range of 30 cm.
Ambient Light Sensor	Adjusts the Gamma level automatically based on the ambient light detected through the ambient light sensor (ALS).

Parental Control

To access the **Parental Control** menu, you must first set a password. Once the password is set, you may configure the following items.

Item	Options and descriptions
Auto Power Off	Enables/Disables the automatic shutting off of the projector after the amount of time selected in the Timer Setting field.
Timer Setting	Allows you to sets the amount of time in hours and minutes after which the projector automatically powers off.
Change System Passcode	Allows you to change the system passcode.

Installation

The following table describes the items available in the **Installation** menu:

Item	Options and descriptions
Projector Position	Chooses the position in which the projector is installed. See Choosing a location on page 28 for more details.
Auto Focus	Allows you to further configure the projector's auto focus function. Options include: Real Time Adjustment and Sensitivity .
Geometry Correction	Allows you to select which type of image adjustment you want to configure. Options include: Keystone and Corner Fit . Once you select a type of image adjustment use the field below to make your adjustments.
Keystone Setting / Corner Fit Setting	Allows you to adjust the type of image adjustment in the Geometry Correction field. See Correcting keystone on page 40 and Corner Fit on page 41 for more details.
Test Pattern	Displays the test pattern grid, which helps you adjust the image size and focus to check if the projected image is free of distortion.

Item	Options and descriptions
HDMI Settings	<p>Allows you to further configure HDMI settings</p> <ul style="list-style-type: none"> • HDMI Format: Selects a suitable color format to optimize display quality. • HDMI EDID: Switches the HDMI EDID between Enhanced (HDMI 2.0) or Standard (HDMI 1.4) in order to solve compatibility issue with certain old players.
Aspect Ratio	<p>There are several options to set the image's aspect ratio depending on your input signal source. Options include:</p> <ul style="list-style-type: none"> • Auto: Scales an image proportionally to fit the projector's native resolution in its horizontal or vertical width. • Real: Projects an image as its original resolution and resizes it to fit within the display area. For input signals with lower resolutions, the projected image will be displayed in its original size. • 4:3: Scales an image so that it is displayed in the center of the screen with a 4:3 aspect ratio. • 16:9: Scales an image so that it is displayed in the center of the screen with a 16:9 aspect ratio.
High Altitude Mode	<p>We recommend you use the High Altitude Mode when your environment is between 1500 m - 2000 m above sea level, and ambient temperature is between 0°C to 30°C.</p> <p>Operation under High Altitude Mode may cause a higher decibel operating noise level because of increased fan speed necessary to improve overall system cooling and performance.</p> <p>If you use this projector under other extreme conditions excluding the above, it may display auto shut-down symptoms, which is designed to protect your projector from over-heating. In cases like this, you should switch to High Altitude Mode to solve these symptoms. However, this is not to state that this projector can operate under any and all harsh or extreme conditions.</p> <p> Do not use the High Altitude Mode if your altitude is between 0 m and 1500 m and ambient temperature is between 0°C to 35°C. The projector will be over cooled, if you turn the mode on under such a condition.</p>

System

The following table describes the items available in the **System** menu:

Item	Options and descriptions
Language	Sets the language for the projector.  Changing the language setting in this menu will not change the language used in Android TV . To change Android TV 's language use the settings menu on the home screen.
System Update	Allows you to update the software on the projector via a USB flash drive. This is for service use only.
System Information	Displays hardware/software information for the projector including its device name, operating system version, memory, and storage capacity.
Projector Information	Displays information on the current status of the projector including the current Detected Resolution, Source, Picture Mode, Power Mode, Color System, Light Source Usage Time, Firmware Version, and Service Code.
Factory Reset	Returns the projector to its factory default state.

Maintenance

Care of the projector

Your projector needs little maintenance. The only thing you have to do on a regular basis is keep the lens clean.

Never remove any parts of the projector. Contact your dealer or local customer service center if the projector fails to operate as expected.

Cleaning the lens

Clean the lens whenever you notice dirt or dust on the surface.

Before cleaning any part of the projector, turn it off using the proper shutdown procedure (see [Shutting down the projector on page 37](#)), unplug the power cable, and let it cool down completely.

- Use a canister of compressed air to remove dust.
- If there is dirt or smears, use lens-cleaning paper or moisten a soft cloth with lens cleaner and gently wipe the lens surface.
- Never use any type of abrasive pad, alkaline/acid cleaner, scouring powder, or volatile solvent, such as alcohol, benzene, thinner or insecticide. Using such materials or maintaining prolonged contact with rubber or vinyl materials may result in damage to the projector surface and cabinet material.

 Never touch the lens with your finger or rub the lens with abrasive materials. Even paper towels can damage the lens coating. Only ever use a proper photographic lens brush, cloth, and cleaning solution. Do not attempt to clean the lens while the projector is switched on or is still hot from previous use.

Storing the projector

To store the projector for an extended time:

- Make sure the temperature and humidity of the storage area are within the recommended range for the projector. Refer to [Specifications \(page 70\)](#) or consult your dealer about the range.
- Retract the adjuster feet.
- Remove the batteries from the remote control.
- Pack the projector in its original packing or equivalent.

Transporting the projector

It is recommended that you ship the projector with its original packing or equivalent.

Product care after outdoor use

Your projector is splash-proof, allowing it to be used outdoors. Anytime the projector is used outdoors, remember to follow the care instructions in this chapter and the cleaning instructions described in [Important safety instructions on page 9](#).

This projector is not designed to be used directly in the rain, though. If your projector got wet by accident, hold the projector upright to clear water properly from the holes on the bottom, and keep it air dry. Do not shake the projector to remove water.

Extending LED life

The LED headlight includes a bulb which features a light-source life far beyond traditional bulbs, yet it is still a consumable item. To keep the LED life as long as possible, you can change the following settings via the settings menu.

To access the settings menu, see [Using the Settings menu on page 57](#) for details.

Setting LED Mode

Set the projector **Power Mode** to **Eco Mode** or **Low Power** to extend the LED life.

LED mode	Description
Normal	100% LED brightness.
Eco Mode	This setting reduces system noise and power consumption by 30%. If Eco Mode is selected, the light output will be reduced and result in darker projected pictures.
Low Power	Lowers brightness to 50% to extend the LED life.

1. Press the **PROJECTOR MENU** button on the remote control.
1. Select **Power Mode**.
2. Press (**▲/▼**) to move to your desired mode.

3. When done, press \hookrightarrow to save your changes and exit.

Troubleshooting

If your problems remain after checking this manual, please contact your place of purchase or visit the local website from Support.BenQ.com for more support and local customer service.



Support.BenQ.com

Problem	Cause	Remedy
The projector does not turn on.	There is no power from the power cable.	Plug the power cable into the AC inlet on the rear of the projector, and plug the power cable into to the power outlet. If the power outlet has a switch, make sure that it is switched on.
	The battery is running out and in low voltage.	Plug in power adapter to charge the projector until the LED indicator turns solid green; then press and hold the power button on the projector for 3 seconds to turn it on.
The projector cannot project the screen on mobile phones or laptops via USB-C cables.	The mobile phones or laptops do not have DisplayPort functionality.	Make sure the USB-C port on the device has DisplayPort functionality (with a DisplayPort IC inside), supports DisplayPort version 1.1 (or above) and timings as listed in Timing chart on page 72 .
	The USB-C cable is not compatible.	Use a USB-C Gen 3.1 cable to ensure sufficient bandwidth for media data transmission.
The projector cannot connect with Bluetooth speakers or headphones.	The Bluetooth function is not enabled.	Make sure the Bluetooth function on both the Bluetooth device and the projector are enabled. See Pairing/Connecting to a Bluetooth speaker or headphones on page 54 for more details.
	The Bluetooth device and the projector are not within an 8 meter range of each other.	

Problem	Cause	Remedy
The projector cannot play files in storage devices via USB-A ports.	The storage device is not connected to the projector properly.	Make sure your storage device is fully inserted into the USB-A port on the projector.
	The projector does not support the file formats.	See Supported file formats on page 75 for more information about file formats supported by the projector.
Screen brightness is changed.	The adapter is removed.	The light brightness is decreased in Eco Mode and Low Power to support longer projection. If a brighter screen is preferred, connect the power adapter to the projector or change the Power Mode to Normal .
	The adapter is not removed but the Power Mode is switched to Eco Mode or Low Power .	
No input source.	The video source is not turned on or connected correctly.	Turn the video source on and check that the signal cable is connected correctly.
	The projector is not correctly connected to the input source device.	Check the connection. If input source is the USB-C port, make sure the source device supports DisplayPort and is connected to the projector with a USB-C Gen 3.1 cable.
	The video or audio file format is not supported by the projector.	Make sure the supported file format as described in Supported file formats on page 75 is being played, or contact the customer service for assistance.
Image or audio is unstable.	The connection cables are not securely connected to the projector or the signal source.	Correctly connect the cables to the appropriate terminals.
	The Internet bandwidth is limited or over-occupied.	Connect to another wireless AP or to an Internet channel of better speed.
	The projector is out of effective range of Bluetooth connection.	Make sure the projector is within the effective range of Bluetooth connection. Make sure there is as less radio frequency interference as possible when using a 2.4G network.

Problem	Cause	Remedy
Picture is blurred.	The projection lens is not correctly focused.	Adjust the focus of the lens using focus button on the remote control.
	The projector and the screen are not aligned properly.	Adjust the projection angle and direction as well as the height of this projector if necessary.
Remote control does not work correctly.	The batteries are out of power.	Replace both of the batteries with new ones.
	There is an obstacle between the remote control and the projector.	Remove the obstacle.
	You are too far away from the projector.	Stand within 8 meters (26.2 feet) of the projector.
The projector cannot connect to the desired SSID.	The handshaking between the projector and the router does not follow IEEE 802.11 protocols.	<ul style="list-style-type: none"> • For 2.4G frequency, make sure the wireless mode of the router is configured as 802.11g/n or 802.11n. • For 5G frequency, make sure the wireless mode of the router is configured as 802.11n.

Specifications

Projector specifications



All specifications are subject to change without notice.

Specifications	
Projection System	DLP
DMD Type	0.23"
Native Resolution	1920 x 1080 pixels
Brightness	500 ANSI Lumens
Contrast Ratio	100,000:1
Display Color	1.07 Billion Colors
Aspect Ratio	16:9
Light Source	LED
Light Source Life⁽¹⁾	20,000 hours (Normal) / 30,000 hours (Eco)
Throw Ratio	1.21 (37.4"@1M)
Zoom Ratio	Fixed
Keystone Correction	Auto Vertical Keystone \pm 40 degrees Manual Horizontal Keystone \pm 40 degrees
Projection Offset	100% \pm 5%
Projection Size	30 to 112 inches
Waterproof rating	IPX2

Specifications		
Interface	<ul style="list-style-type: none"> • USB-A (2.0)(5V/1.5A/Reader) x 1 • USB-C (DisplayPort 1.2)(5V/1.5A) x 1 • HDMI 2.0b x 1 • 3.5mm Audio Out x 1 • Panel Key Lock x 1 	
Power	DC Supply	
	Frequency	AC 100 to 240V 50/60HZ 1.5A
	Power Rating	19.0V, 4730.0mAh, approximately 90.0W
	Battery Life	
	Type	Lithium-ion battery
	Electrical Rating	11.1V 6000.0mAh, 66.6W
	Battery Cycle Life	500 cycles
	Charging Time	3 hours from 0% to 100%
	Battery Life	2.5 hours (USB reader under Low Power mode)
Built-in Speaker	5W Chamber x 2 + 10W Bass	
Resolution Support	HDMI: VGA (640 x 480) to 4K UHD (3840 x 2160) USB-C: VGA (640 x 480) to 1080P(1920 x 1080)	
Horizontal Frequency	15 to 102 KHz	
Vertical Scan Rate	23 to 85 Hz	
HDTV Compatibility	480i, 480p, 576i, 576p, 720p, 1080i, 1080p, 2160P	
Video Compatibility	NTSC / NTSC4.43 / PAL / M-PAL / N-PAL / PAL60 / SECAM / HDTV	



- LED life results will vary depending on environmental conditions and usage.
- The performance of WLAN and Bluetooth might be disturbed by distance and obstacles.

Timing chart

Supported timing for video input

Timing	Resolution	H. Frequency (KHz)	V. Frequency (KHz)	Dot Clock Frequency (MHz)
480i	720 (1440) × 480	15.73	59.94	27
480p	720 × 480	31.47	59.94	27
576i	720 (1440) × 576	15.63	50	27
576p	720 × 576	31.25	50	27
720/50p	1280 × 720	37.5	50	74.25
720/60p	1280 × 720	45.00	60	74.25
1080/24p	1920 × 1080	27	24	74.25
1080/25p	1920 × 1080	28.13	25	74.25
1080/30p	1920 × 1080	33.75	30	74.25
1080/50i	1920 × 1080	28.13	50	74.25
1080/60i	1920 × 1080	33.75	60	74.25
1080/50p	1920 × 1080	56.25	50	148.5
1080/60p	1920 × 1080	67.5	60	148.5
2160/24p	3840 × 2160*	54	24	297
2160/25p	3840 × 2160*	56.25	25	297
2160/30p	3840 × 2160*	67.5	30	297
2160/50p	3840 × 2160*	112.5	50	594
2160/60p	3840 × 2160*	135	60	594



Supported by HDMI 2.0 only.

Supported timing for PC input

Resolution	Mode	Refresh Rate (Hz)	H. Frequency (KHz)	Dot Clock Frequency (MHz)
640 x 480	VGA_60	59.940	31.469	25.175
	VGA_72	72.809	37.861	31.500
	VGA_75	75.000	37.500	31.500
	VGA_85	85.008	43.269	36.000
720 x 400	720 x 400_70	70.087	31.469	28.322
800 x 600	SVGA_60	60.317	37.879	40.000
	SVGA_72	72.188	48.077	50.000
	SVGA_75	75.000	46.875	49.500
	SVGA_85	85.061	53.674	56.250
1024 x 768	XGA_60	60.004	48.363	65.000
	XGA_70	70.069	56.476	75.000
	XGA_75	75.029	60.023	78.750
	XGA_85	84.997	68.667	94.500
1152 x 864	1152 x 864_75	75.000	67.500	108.000
1280 x 720	1280 x 720_60	60.000	45.000	74.250
1280 x 768	1280 x 768_60	59.870	47.776	79.500

Resolution	Mode	Refresh Rate (Hz)	H. Frequency (KHz)	Dot Clock Frequency (MHz)
1280 x 800	SVGA_60	59.810	49.702	83.500
	SVGA_75	74.934	62.795	106.500
	XGA_85	84.880	71.554	122.500
1280 x 1024	SXGA_60	60.020	63.981	108.000
	SXGA_75	75.025	79.976	135.000
1280 x 960	1280 x 960_60	60.000	60.000	108.000
	1280 x 960_85	85.002	85.938	148.500
1360 x 768	1360 x 768_60	60.015	47.712	85.500
1440 x 900	WXGA+_60	59.887	55.935	106.500
1440 x 1050	SXGA+_60	59.978	65.317	121.750
1680 x 1050	1680 x 1050_60	59.954	65.290	146.250
640 x 480@67 Hz	MAC13	66.667	35.000	30.240
832 x 624@75 Hz	MAC16	74.546	49.722	57.280
1024 x 768@75 Hz	MAC19	75.020	60.241	80.000
1152 x 870@75 Hz	MAC21	75.060	68.680	100.000
1920 x 1080@60 Hz	1920 x 1080_60	60.000	67.500	148.500
3840 x 2160 (supported by HDMI 2.0 only)	3840 x 2160_30	30	67.5	297
	3840 x 2160_60	60	135	594

 The timings showing above may not be supported for due to EDID file and VGA graphic card limitations. It is possible that some timings cannot be chosen.

Supported file formats

File type	File extension
Documents	.txt
Photos	JPG(.jpg, .jpeg), PNG(.png), BMP(.bmp)
Music	MP3(.mp3), AAC(.aac)
Video	XVID(.avi) MPEG-4(3gp, mp4) H.263(3g2, .avi, .mkv, .webm, 3gp, mp4)
Subtitles	N/A



Bit rate range: If the peak bit rate of a video file is larger than 10MB, it might cause video playback lag.

Appendix

Installing the projector on a tripod (purchased separately)

Use a tripod plate to mount the projector onto a tripod:

1. Install the tripod's quick release plate to the projector's tripod screw hole and tighten the plate's screw.

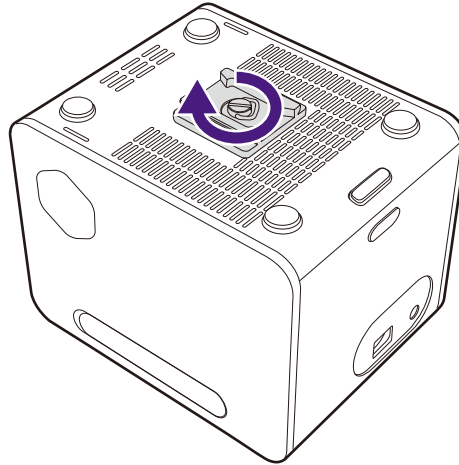

2. Install the projector onto the tripod.

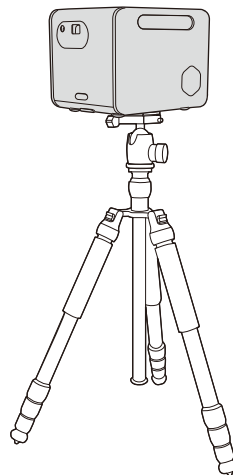

Copyright and disclaimer

Copyright

Copyright © 2021 by BenQ Corporation. All rights reserved. No part of this publication may be reproduced, transmitted, transcribed, stored in a retrieval system or translated into any language or computer language, in any form or by any means, electronic, mechanical, magnetic, optical, chemical, manual or otherwise, without the prior written permission of BenQ Corporation.

All other logos, products, or company names mentioned in this manual may be the registered trademarks or copyrights of their respective companies, and are used for informational purposes only.

Android™ is a trademark of Google LLC.

The Bluetooth® word mark and logos are registered trademarks owned by Bluetooth SIG, Inc. and any use of such marks by BenQ Corporation is under license.

iOS is a trademark or registered trademark of Cisco in the U.S. and other countries and is used under license.

macOS® is a trademark of Apple Inc., registered in the U.S. and other countries.

USB-C™ is a trademark of the USB Implementers Forum.

Disclaimer

BenQ Corporation makes no representations or warranties, either expressed or implied, with respect to the contents hereof and specifically disclaims any warranties, merchantability or fitness for any particular purpose. Further, BenQ Corporation reserves the right to revise this publication and to make changes from time to time in the contents hereof without obligation of BenQ Corporation to notify any person of such revision or changes. This user manual aims to provide the most updated and accurate information to customers, and thus all contents may be modified from time to time without prior notice. Please visit <http://www.benq.com> for the latest version of this manual.

Warranty

BenQ warrants this product against any defects in material and workmanship, under normal usage and storage.

Proof of purchase date will be required with any warranty claim. In the event this product is found to be defective within the warranty period, BenQ's only obligation and your exclusive remedy shall be replacement of any defective parts (labor included). To obtain warranty service, immediately notify the dealer from which you purchased the product of any defects.

Important: The above warranty shall be void if the customer fails to operate the product in accordance with BenQ's written instructions, especially the ambient humidity must be in-between 10% and 90%, temperature in-between 0°C and 40°C, altitude lower than 2000 meters, and avoiding to operate the projector in a dusty environment. This warranty gives you specific legal rights, and you may have other rights which vary from country to country.

For other information, please visit www.BenQ.com.

Statement regarding hyperlinks and third-party websites

BenQ is not responsible for the content of the websites or of similar resources, which are maintained and controlled by third parties, that may be linked from this product. Providing links to those websites or to similar resources does not mean that BenQ makes any warranty or representation to their content by expression or by implication.

Any third party content or service preinstalled in this product is provided "as is". BenQ does not, by expression or by implication, make any warrant to the content or to the services provided by third parties. BenQ does not warrant or guarantee that the content or services provided by third parties are accurate, effective, most up-to-date, legal, or complete. Under no circumstances shall BenQ be liable for the content or services provided by third parties including their negligence.

Services provided by third parties may be terminated temporarily or permanently. BenQ does not warrant or guarantee that any content or services provided by third parties are in good condition at any time, and is not liable for the termination of the said content and services.

In addition, BenQ is not involved in any transactions you conduct in the websites or similar resources maintained by third parties.

You should contact the content or service providers for any questions, concerns, or disputes.