

# BenQ Colorific™ HCI200

Introducing the First sRGB Color Projector.

PREFERRED  
**7 to 1\***



- Accurate sRGB Color
- Up to 2X More ANSI Contrast
- No Color Fade Certified
- For Business or Home



## Touchboards

205 Westwood Ave, Long Branch, NJ 07740  
Phone: 866-94 BOARDS (26273) / (732)-222-1511  
Fax: (732)-222-7088 | E-mail: sales@touchboards.com

**BenQ.us & BenQ.ca**

BenQ is a registered trademark of BenQ Corp. All rights reserved. Product names, logos, brands, and other trademarks featured or referred to in this material are the property of their respective trademark holders. Specifications subject to change without notice.

\*Over other 4,000 lumen projectors for brightness and color accuracy. Based on end user research.



Because it matters

# Experience Colorific™

Accurate, crisp, and long-lasting color

## Color accuracy and the right brightness make BenQ's HC1200 the ideal choice for conference room or home theater use

BenQ's HC1200 is purpose-built to follow the sRGB (standard Red, Green, Blue) color standard. sRGB is a well-known and widely used standard for color accuracy in monitors, printers, cameras, and throughout the internet. It is intended as a guide to preserve and reproduce colors the way they are meant to be shown. The HC1200's 2,800 sRGB lumens has the ability to subtly differentiate between difficult to reproduce colors enabling the projector to deliver a more accurate image that appears brighter than a typical 4,000 lumen conference room projector<sup>1</sup>.

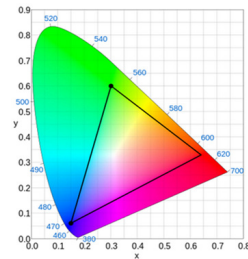

The red, green, and blue color coordinates make up the sRGB color triangle. This is an industry-wide standard to ensure color accuracy.

## Up to 2X more ANSI contrast for more crisp and highly detailed images

The BenQ HC1200 not only delivers an impressive 10,000:1 ON/OFF contrast; it also has up to 2X more ANSI contrast than a typical projector in its class. This means the projector is able to better differentiate between dark and light content within the same image. With higher ANSI contrast, you can always expect a crisp and richly detailed image.

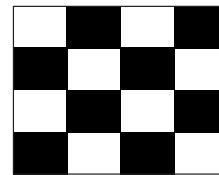

ANSI contrast uses a black and white checkerboard measurement approach to assess a projector's ability to simultaneously show detail in the dark and lighter portions of an image.

## No color fade certified

At BenQ, we have worked hard to make sure our projectors deliver long-lasting, high quality imaging. Unlike traditional LCD projectors that may experience color fade over time, BenQ's HC1200 ensures that your color will not fade. The color you see now will be the same color you will see years from now!

Traditional LCD projector with color fade



BenQ Colorific™ Technology



## See the comparison yourself

HC1200 Colorific Projector    Color Calibrated LCD Monitor<sup>2</sup>

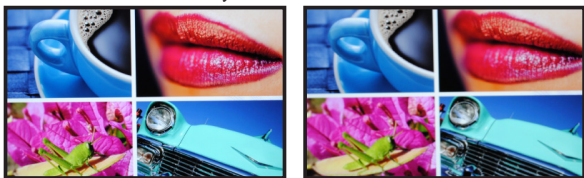

Vibrant images easily replicated for great presentations



Proper reproduction of hues and saturation for life-like realism



Natural skin and hair tones for when the details matter

Images: Actual photographs of a color calibrated LCD monitor and BenQ's HC1200 projector. Both the monitor and the projector support 100% sRGB color space for extremely high color accuracy.

Traditional Projectors	BenQ HC1200
Focus on image brightness	Focus on sRGB color accuracy
Emphasize On/Off Contrast	Delivers up to 2X more ANSI Contrast
Risk of color fade over time	Certified no color fade
No color space specification	100% sRGB color standard

<sup>1</sup> Based on independent end-user focus group study.

<sup>2</sup> Monitor model has been certified by the IDEA Alliance G7 Standard for color proofing accuracy.

BenQ.us • BenQ.ca

BenQ is a registered trademark of BenQ Corp. All rights reserved. Product names, logos, brands, and other trademarks featured or referred to in this material are the property of their respective trademark holders. Specifications subject to change without notice.



Because it matters

# HCI200 Specifications and Interfaces

Specifications	
Projection System	BenQ Colorific™ DLP™ Technology
Color Accuracy	100% sRGB Color
Number of Colors	1 billion – 10 bit processing
sRGB Lumens	2,800 lumens
Comparable Brightness	4,000 lumens*
Resolution	1080p
Contrast (On/ Off)	10,000:1
Contrast ANSI Checkerboard	510:1
Zoom	1.5x – (Supports 2.35:1 Cinemascope)
Image Size	26" – 300"
Keystone	Vertical +/- 40 degrees
Offset	Vertical: 130% + 5%
Lamp Hours	Up to 3,500 hours

Interfaces
Dual HDMI
Dual D-Sub
Monitor Out
Composite Video in
S-Video in
Audio in (Mini Jack)
Audio in (L/R)
Audio out (Mini Jack)
5Wx1 Speaker
USB Type B
DC12V Trigger
Accessories (Optional)
Spare Lamp Kit P/N: 5J.J8805.001
Ceiling Mount P/N: 5J.J4N10.001
Carry Bag P/N: 5J.J4R09.001
Remote P/N: 5J.J8A06.001

Other Specifications	
Networking	RJ45 & RS232
User Modes	sRGB, Presentation, Cinema, Photo, User 1, User 2, Dynamic
Lens	F=2.42~2.97, f=20.7~31.05mm
Vertical Scan Rate	23~120Hz
Weight	8.14 lbs (3.7 kg)
Warranty	3 Year Warranty
Lamp Warranty	1 Year or 2,000 Hours of Lamp Life
UPC Code	8400460-3101-5
P/N	9H.JDA77.23A
Audible Noise	38/33 dBA (Normal/ Economic mode)
What's in the box	
Carry Bag	
Remote w/ Battery	
User Manual CD	
Lens Cover	
Power Cord	
VGA Cable	
Warranty Card	

\*Based on independent focus group study.

## Input/Output Terminals

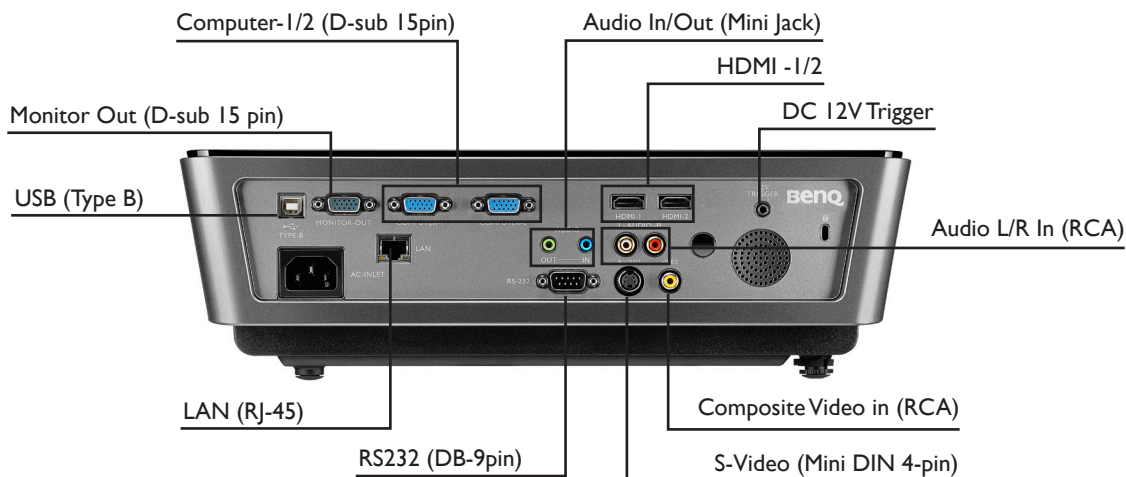

# Distance Chart

Installation for a 16:9 ratio screen

Image Size				Distance (inch)			Offset (inch)
Diagonal		Height (inch)	Width (inch)	Min distance	Average	Max distance	A (inch) @ Wide mode
Inch	mm						
50	1270	24.5	43.5	60.9	75.9	91.0	3.6
60	1524	29.4	52.1	73.1	91.2	10.8	4.4
70	1778	34.3	61.0	85.2	106.4	127.5	5.1
80	2032	39.2	69.7	97.4	121.6	145.7	5.8
90	2086	44.1	78.4	109.6	136.8	163.9	6.6
100	2540	49.0	87.1	121.8	152.0	182.1	7.4
110	2794	53.9	95.8	134.0	167.2	200.3	8.1
120	3048	58.8	104.6	146.2	182.4	218.5	8.8
130	3302	63.7	113.3	158.3	197.5	236.8	9.5
140	3556	68.6	121.8	170.5	212.7	255.0	10.3
150	3810	73.5	130.7	182.7	227.9	273.2	11.0
160	4064	78.4	139.4	194.9	243.1	291.4	11.7
170	4318	83.3	148.1	207.1	258.3	309.6	12.5
180	4572	88.2	156.8	219.3	273.6	327.8	13.2
190	4826	93.1	165.5	231.4	288.8	346.1	13.9
200	5080	98.0	174.3	243.7	304.0	364.3	14.7
250	6350	122.5	217.9	304.6	380.0	455.3	18.3
300	7620	147.1	261.4	365.5	456.0	546.4	22.0

## Floor Installation

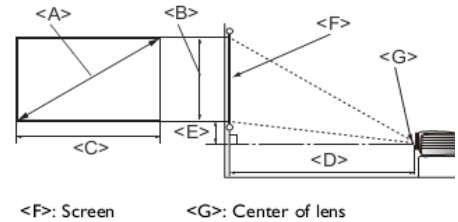

## Ceiling Installation

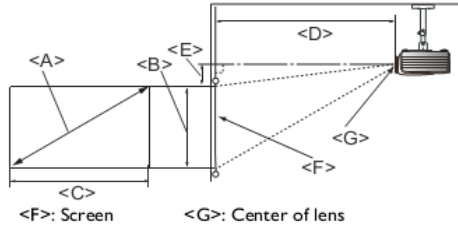

# Ceiling Mount Chart

Units: Inch

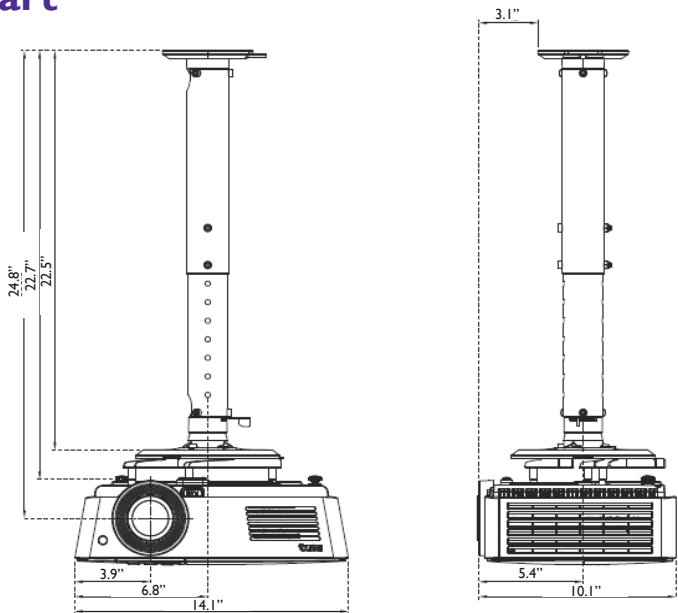

# Dimensions



# Touchboards

205 Westwood Ave, Long Branch, NJ 07740  
 Phone: 866-94 BOARDS (26273) / (732)-222-1511  
 Fax: (732)-222-7088 | E-mail: sales@touchboards.com

BenQ.us • BenQ.ca



BenQ is a registered trademark of BenQ Corp. All rights reserved. Product names, logos, brands, and other trademarks featured or referred to in this material are the property of their respective trademark holders. Specifications subject to change without notice.