



LK970
DLP Projector
User Manual

Warranty and Copyright information

Limited warranty

BenQ warrants this product against any defects in material and workmanship, under normal usage and storage.

Proof of purchase date will be required with any warranty claim. In the event this product is found to be defective within the warranty period, BenQ's only obligation and your exclusive remedy shall be replacement of any defective parts (labor included). To obtain warranty service, immediately notify the dealer from which you purchased the product of any defects.

Important: The above warranty shall be void if the customer fails to operate the product in accordance with BenQ's written instructions, especially the ambient humidity must be in-between 10% and 90%, temperature in-between 0°C and 40°C, altitude lower than 3000 m (used with High Altitude Mode), and avoiding to operate the projector in a dusty environment. This warranty gives you specific legal rights, and you may have other rights which vary from country to country.

For other information, please visit www.BenQ.com.

Copyright

Copyright © 2017 by BenQ Corporation. All rights reserved. No part of this publication may be reproduced, transmitted, transcribed, stored in a retrieval system or translated into any language or computer language, in any form or by any means, electronic, mechanical, magnetic, optical, chemical, manual or otherwise, without the prior written permission of BenQ Corporation.

Disclaimer

BenQ Corporation makes no representations or warranties, either expressed or implied, with respect to the contents hereof and specifically disclaims any warranties, merchantability or fitness for any particular purpose. Further, BenQ Corporation reserves the right to revise this publication and to make changes from time to time in the contents hereof without obligation to notify any person of such revision or changes.

*DLP, Digital Micromirror Device and DMD are trademarks of Texas Instruments. Others are copyrights of their respective companies or organizations.

Patents

Please go to <http://patmarking.benq.com/> for the details on BenQ projector patent coverage.

Table of Contents

Warranty and Copyright information	2
Important safety instructions	4
Introduction	6
Shipping contents	6
Projector exterior view	7
Control Panel	8
Control terminals	9
Remote control	10
Installation	12
Choosing a location	12
Cooling notice	12
Obtaining a preferred projected image size.....	13
Mounting the projector	14
Adjusting the projector position	14
Adjusting the projected image	15
Connection	17
Operation	19
Starting up the projector	19
Using the menus	20
Securing the projector	21
Switching input signal	22
Shutting down the projector	23
Menu operation	24
PICTURE menu	24
DISPLAY menu.....	28
INSTALLATION menu	28
SYSTEM SETUP: BASIC menu	30
SYSTEM SETUP: ADVANCED menu	31
INFORMATION menu	32
Maintenance	33
Care of the projector	33
Light source information	34
LED Indicators.....	35
Troubleshooting	36
Specifications	37
Projector specifications	37
Dimensions	38
Timing chart.....	40
RS232 command.....	44

Important safety instructions

Your projector is designed and tested to meet the latest standards for safety of information technology equipment. However, to ensure safe use of this product, it is important that you follow the instructions mentioned in the user manual / installation guide and marked on the product.

1. **Please read the user manual / installation guide before you operate your projector.** Save it for future reference.
2. **Do not look straight at the projector lens during operation.** The intense light beam may damage your eyes.
3. **Refer servicing to qualified service personnel.**
4. **Always open the lens shutter (if any) or remove the lens cap (if any) when the projector light source is on.**
5. The light source becomes extremely hot during operation.
6. In some countries, the line voltage is NOT stable. This projector is designed to operate safely within a mains voltage between 100 to 240 volts AC, but could fail if power cuts or surges of ± 10 volts occur. **In areas where the mains voltage may fluctuate or cut out, it is recommended that you connect your projector through a power stabilizer, surge protector or uninterruptible power supply (UPS).**
7. Do not block the projection lens with any objects when the projector is under operation as this could cause the objects to become heated and deformed or even cause a fire. To temporarily turn off the light source, use the blank function.
8. Do not operate light sources beyond the rated light source life.
9. Do not place this product on an unstable cart, stand, or table. The product may fall, sustaining serious damage.
10. Do not attempt to disassemble this projector. There are dangerous high voltages inside which may cause death if you should come into contact with live parts.

Under no circumstances should you ever undo or remove any other covers. Refer servicing only to suitably qualified professional service personnel.

11. Do not block the ventilation holes.
 - Do not place this projector on a blanket, bedding or any other soft surface.
 - Do not cover this projector with a cloth or any other item.
 - Do not place inflammables near the projector.If the ventilation holes are seriously obstructed, overheating inside the projector may result in a fire.
12. Do not stand the projector on end vertically. Doing so may cause the projector to fall over, causing injury or resulting in damage to the projector.
13. Do not step on the projector or place any objects upon it. Besides probable physical damage to the projector, doing so may result in accidents and possible injury.
14. When the projector is under operation, you may sense some heated air and odor from its ventilation grill. It is a normal phenomenon and not a product defect.
15. Do not place liquids near or on the projector. Liquids spilled into the projector may cause it to fail. If the projector does become wet, disconnect it from the power supply's power outlet and call BenQ to have the projector serviced.
16. This apparatus must be earthed.
17. Do not place this projector in any of the following environments.

- Space that is poorly ventilated or confined. Allow at least 50 cm clearance from walls and free flow of air around the projector.
- Locations where temperatures may become excessively high, such as the inside of a car with all windows rolled up.
- Locations where excessive humidity, dust, or cigarette smoke may contaminate optical components, shorten the projector's life span and darken the image.
- Locations near fire alarms
- Locations with an ambient temperature above 40°C / 104°F
- Locations where the altitudes are higher than 3000 m (10000 feet).

Risk Group 2

1. According to the classification of photobiological safety of light sources and light source systems, this product is Risk Group 2, IEC 62471-5:2015.
2. Possibly hazardous optical radiation emitted from this product.
3. Do not stare at operating light source. May be harmful to the eyes.
4. As with any bright source, do not stare into the direct beam.



The projector's light source unit uses a laser.

Laser Caution

(For China and other regions) This product belongs to CLASS I laser product and complies with IEC 60825-1:2014.

(For north America) This product belongs to CLASS 3R laser product and complies with IEC 60825-1:2007.

LASER RADIATION, DO NOT STARE INTO BEAM, CLASS 3R LASER PRODUCT.

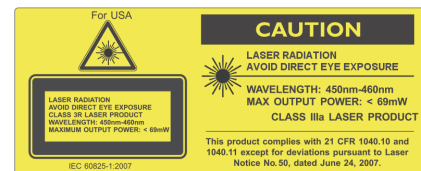

(For north America)



(For China)



(For other regions)

Introduction

Shipping contents

Carefully unpack and verify that you have all of the items shown below. If any of these items are missing, please contact your place of purchase.

Standard accessories

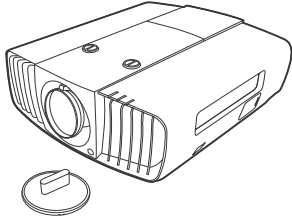

Projector

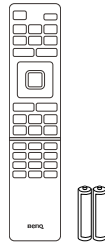

Remote control with batteries



Installation guide

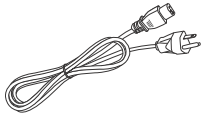

Power cord

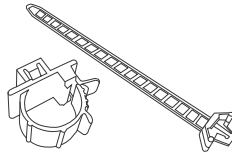

Cable tie set x 2



Rubber cap



The supplied accessories will be suitable for your region, and may differ from those illustrated.

Optional accessories

1. Ceiling mount CMG5

Projector exterior view

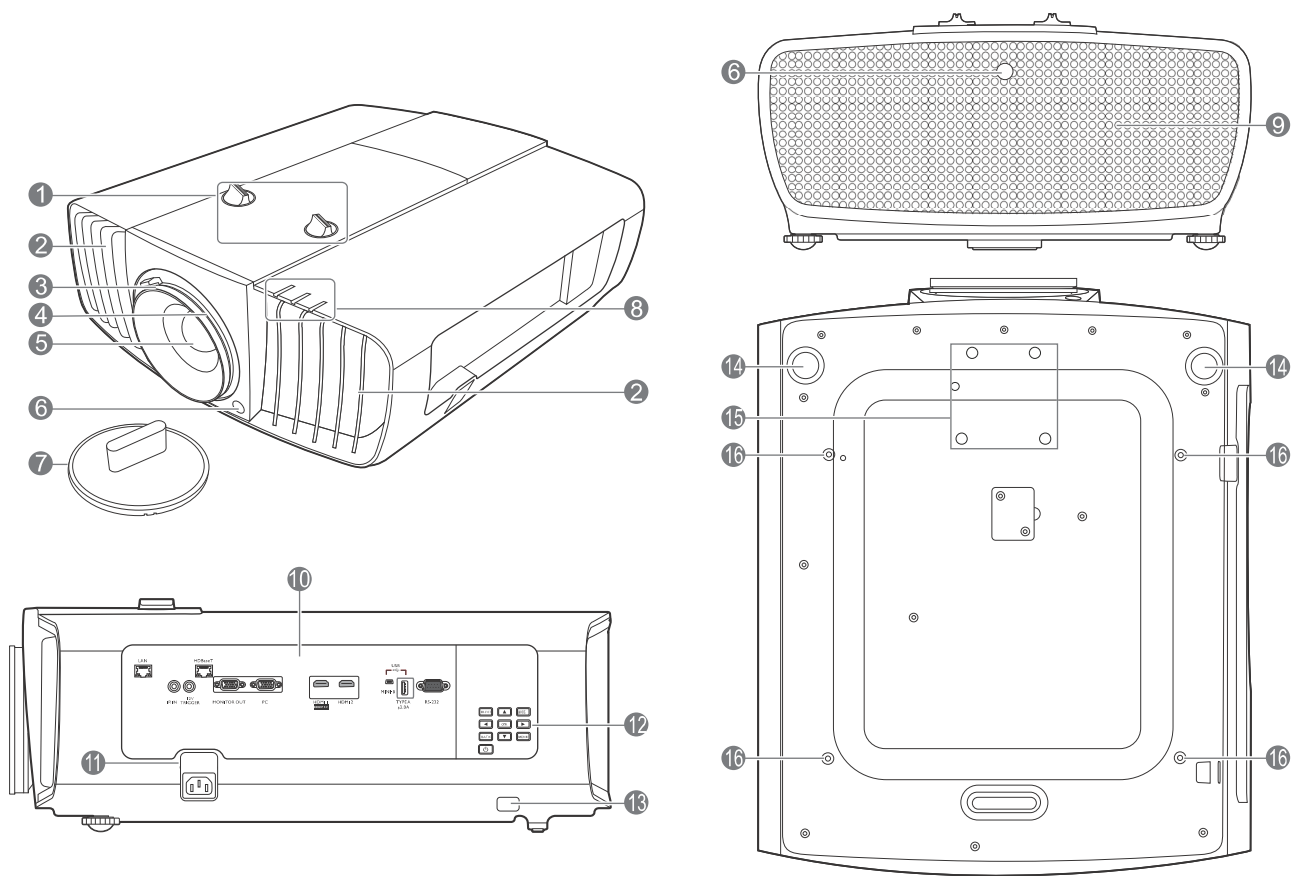

1. Lens shift adjustment knobs (LEFT/RIGHT, UP/DOWN)
2. Vent (heated air exhaust)
3. Focus ring
4. Zoom ring
5. Projection lens
6. IR remote sensor
7. Lens cover
8. POWER indicator light/TEMPerature warning light/LIGHT indicator light (See [LED Indicators on page 35.](#))
9. Vent (cool air intake)
10. Control terminals (See [Control terminals on page 9.](#))
11. AC power jack
12. External control panel (See [Control Panel on page 8.](#))
13. Security bar
14. Adjuster feet
15. Anamorphic lens holes
16. Ceiling mount holes

Control Panel

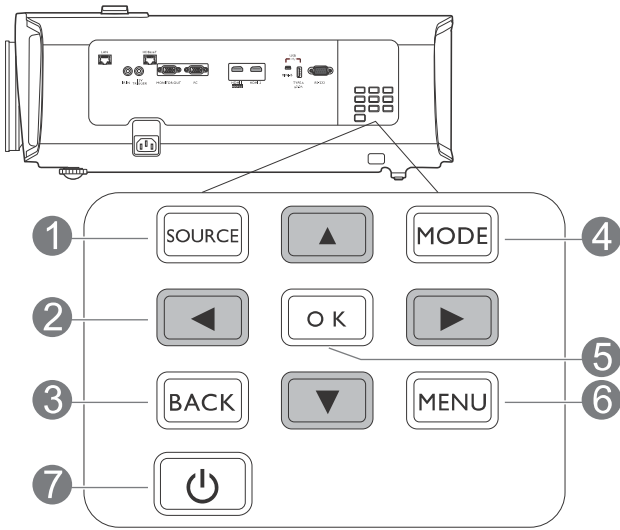

1. **SOURCE**
Displays the source selection bar.
2. **Arrow keys (▲, ▼, ◀, ▶)**
When the On-Screen Display (OSD) menu is activated, these keys are used as directional arrows to select the desired menu items and to make adjustments.
3. **BACK**
Goes back to previous OSD menu, exits and saves menu settings.
4. **MODE**
Selects an available picture setup mode.
5. **OK**
Confirms the selected On-Screen Display (OSD) menu item.
6. **MENU**
Turns on the On-Screen Display (OSD) menu.
7. **I/⏻ POWER**
Toggles the projector between standby mode and on.



All the key presses described in this document are available on the remote control or projector.

Control terminals

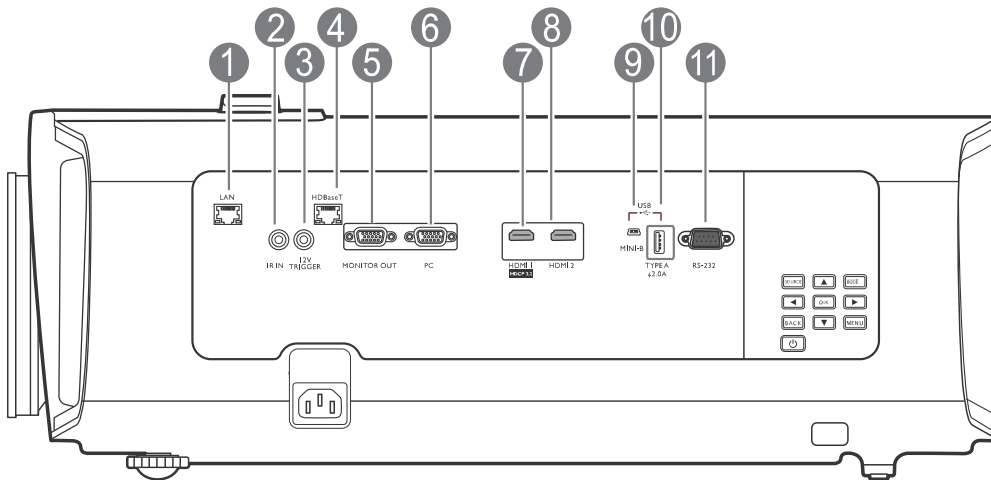

1. LAN

For connection to RJ45 Cat5/Cat6 Ethernet cable to control the projector through a network.

2. IR IN

For use with an IR extender cable to ensure better signal reception from the remote control.

3. 12V TRIGGER

Trigger external devices such as an electric screen or light control, etc.

4. HDBaseT

For connection to RJ45 Cat5/Cat6 cable to input uncompressed high-definition video (HD).

5. MONITOR OUT

Connection to other display equipment for concurrent playback display.

6. PC

15-pin VGA port for connection to RGB source or PC.

7. HDMI 1

Connection to HDMI (4K) source.

8. HDMI 2

Connection to HDMI source.

9. USB MINI-B

For firmware upgrade only.

10. USB TYPE A

Support 5V/2A output.

11. RS232

Standard 9-pin D-sub interface for connection to PC control system and projector maintenance.

Remote control

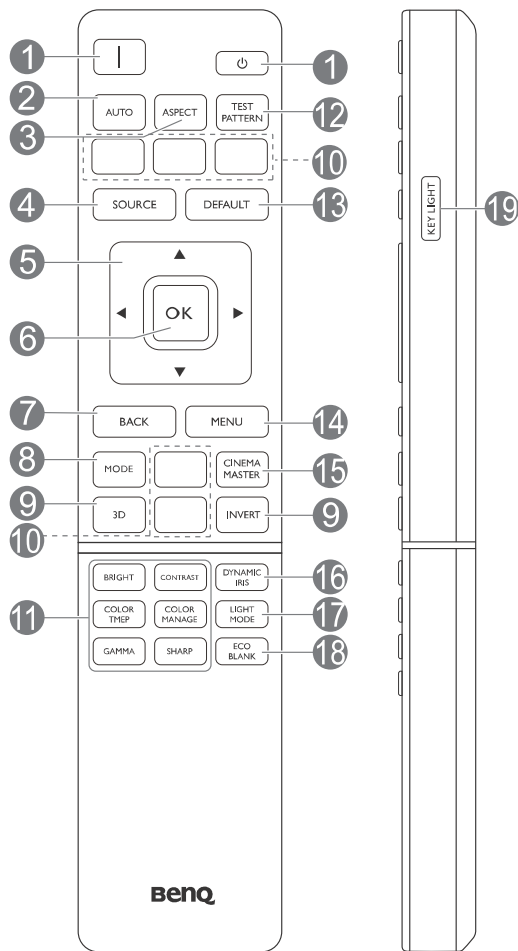

1. **POWER**

Toggles the projector between standby mode and on.

2. **AUTO**

Automatically determines the best picture timings for the displayed image.

3. **ASPECT**

Selects the display aspect ratio.

4. **SOURCE**

Displays the source selection bar.

5. Arrow keys (▲, ▼, ◀, ▶)

When the On-Screen Display (OSD) menu is activated, these keys are used as directional arrows to select the desired menu items and to make adjustments.

6. **OK**

Confirms the selected On-Screen Display (OSD) menu item.

7. **BACK**

Goes back to previous OSD menu, exits and saves menu settings.

8. **MODE**

Selects an available picture setup mode.

9. **3D/INVERT**

The key functions are not available with this model.

10. No function.

11. Picture quality adjustment keys (**BRIGHT, CONTRAST, COLOR TEMP, COLOR MANAGE, GAMMA, SHARP**)

Displays the setting bars for adjustments of the appropriate picture quality values.

12. **TEST PATTERN**

Displays the test pattern.

13. **DEFAULT**

Resets the current function to default factory setting.

14. **MENU**

Turns on the On-Screen Display (OSD) menu.

15. **CINEMAMASTER**

Displays the **CinemaMaster** menu.

See [CinemaMaster on page 27](#).

16. **DYNAMIC IRIS**

The key function is not available with this model.

17. **LIGHT MODE**

Selects a suitable light source power from among the provided modes.

18. **ECO BLANK**

Used to hide the screen picture.



Do not block the projection lens from projecting as this could cause the blocking object to become heated and deformed or even cause a fire.

19. **KEY LIGHT**

Turns on the remote control backlight for a few seconds. To keep the backlight on, press any other key while the backlight is on. Press the key again to turn the backlight off.

Remote control effective range

The remote control must be held at an angle within 30 degrees perpendicular to the projector's IR remote control sensor(s) to function correctly. The distance between the remote control and the sensor(s) should not exceed 8 meters (~ 26 feet).

Make sure that there are no obstacles between the remote control and the IR sensor(s) on the projector that might obstruct the infra-red beam.

- Operating the projector from the front
- Operating the projector from the rear

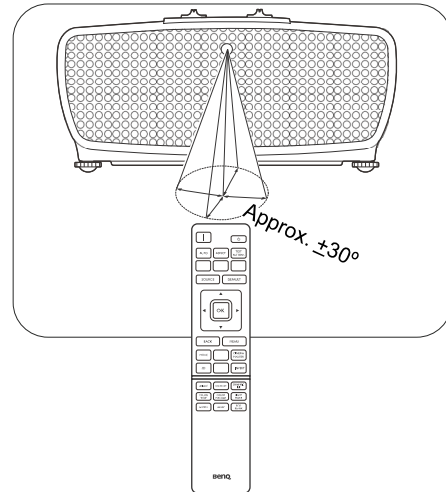
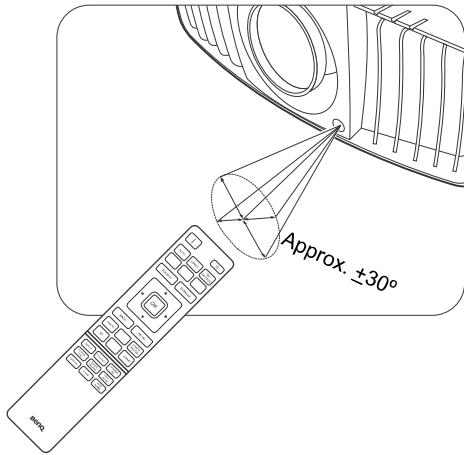

Replacing the remote control batteries

1. Press and slide off the battery cover, as illustrated.
2. Remove the old batteries (if applicable) and install two AAA batteries. Make sure that the positive and negative ends are positioned correctly, as illustrated.
3. Slide the battery cover in until it clicks into place.

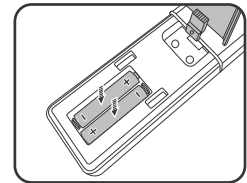
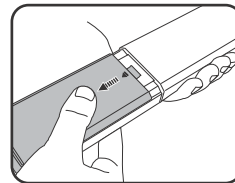

- Avoid leaving the remote control and batteries in an excessive heat or humid environment like the kitchen, bathroom, sauna, sunroom or in a closed car.
- Replace only with the same or equivalent type recommended by the battery manufacturer.
- Dispose of the used batteries according to the manufacturer's instructions and local environment regulations for your region.
- Never throw the batteries into a fire. There may be danger of an explosion.
- If the batteries are dead or if you will not be using the remote control for an extended period of time, remove the batteries to avoid damage to the remote control from possible battery leakage.

Installation

Choosing a location

Before choosing an installation location for your projector, take the following factors into consideration:

- Size and position of your screen
- Electrical outlet location
- Location and distance between the projector and the rest of your equipment

You can install your projector in the following ways: **Front Table, Front Ceiling, Rear Ceiling, Rear Table.**

The projector can also be installed at following angles:

1. 360-degree projection

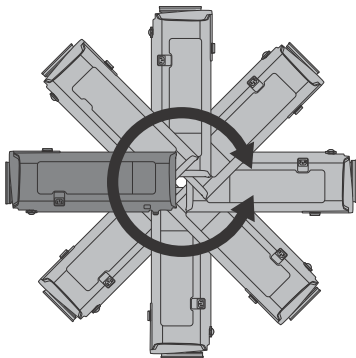

2. Portrait (2 way) projection

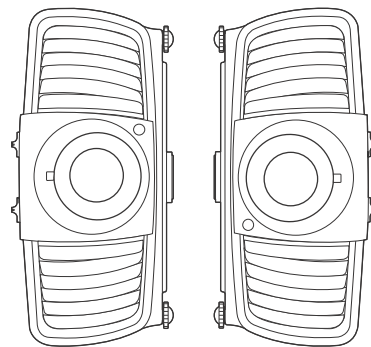

! Installation of the projector should be performed carefully. Incomplete or improper installation may cause the projector to fall, resulting in personal injury or property damage.

Cooling notice

Ventilation

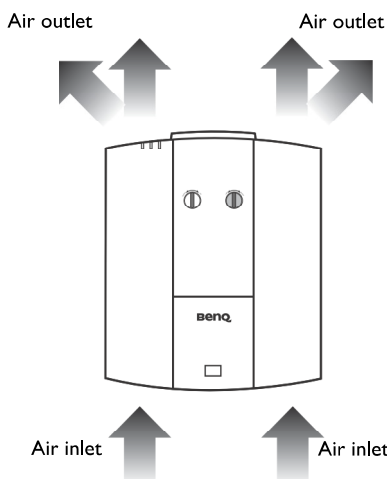

Caution for installation

For proper ventilation of the projector, make sure to leave some space around the projector as shown in the illustration below:

• Table

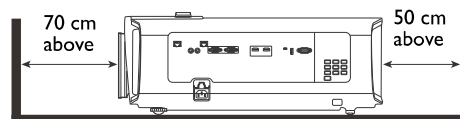

• Table

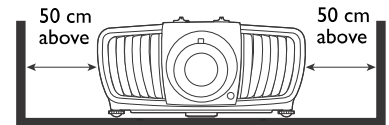

• Ceiling

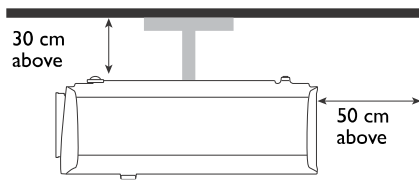

• Stacking

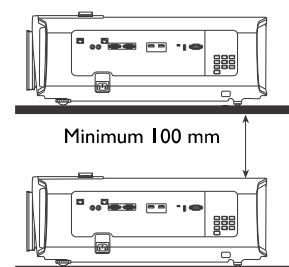

! Avoid using the projector in a poorly ventilated or confined space.

Obtaining a preferred projected image size

The distance from the projector lens to the screen, the zoom setting, and the video format each factors in the projected image size.

Projection dimensions

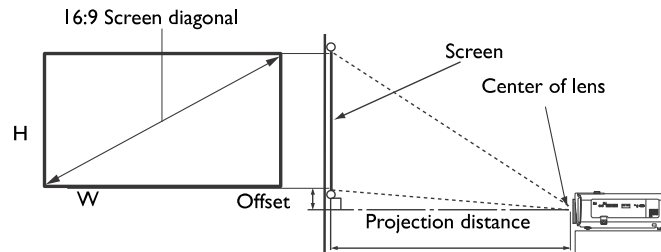

- The screen aspect ratio is 16:9 and the projected picture is in a 16:9 aspect ratio

Screen size				Distance from screen (mm)			Offset (mm)
Diagonal		W (mm)	H (mm)	Min length (max. zoom)	Average	Max length (min. zoom)	
Inch	mm						
40	1016	886	498	1222	1505	1789	50
50	1270	1107	623	1528	1882	2236	62
60	1524	1328	747	1833	2258	2683	75
80	2032	1771	996	2444	3011	3578	100
90	2286	1992	1121	2750	3387	4025	112
100	2540	2214	1245	3055	3763	4472	125
110	2794	2435	1370	3361	4140	4919	137
120	3048	2657	1494	3666	4516	5366	149
130	3302	2878	1619	3972	4893	5813	162
140	3556	3099	1743	4277	5269	6261	174
150	3810	3321	1868	4583	5645	6708	187
160	4064	3542	1992	4888	6022	7155	199
170	4318	3763	2117	5194	6398	7602	212
180	4572	3985	2241	5499	6774	8049	224
190	4826	4206	2366	5805	7151	8497	237
200	5080	4428	2491	6110	7527	8944	249
250	6350	5535	3113	7638	9409	11180	311
300	7620	6641	3736	9165	11290	13416	374
350	8890	7748	4358	10693	13172	15652	436
400	10160	8855	4981	12220	15054	17888	498
500	12700	11069	6226	15275	18817	22359	623

For example, if you are using a 120-inch screen, the recommended projection distance is 4516 mm.

If your measured projection distance is 520 cm, the closest match in the "Distance from screen (mm)" column is 5250 mm. Looking across this row shows that a 140" (about 3.6 m) screen is required.



All measurements are approximate and may vary from the actual sizes.

BenQ recommends that if you intend to permanently install the projector, you should physically test the projection size and distance using the actual projector in situ before you permanently install it, so as to make allowance for this projector's optical characteristics. This will help you determine the exact mounting position so that it best suits your installation location.



- Ceiling installation must be done by a qualified professional. Contact your dealer for more information. It is not recommended you install the projector yourself.
- Only use the projector on a solid, level surface. Serious injury and damage can occur if the projector is dropped.
- Do not use the projector in an environment where extreme temperature occurs. The projector must be used at temperatures between 32 degrees Fahrenheit (0 degrees Celsius) and 104 degrees Fahrenheit (40 degrees Celsius).
- Screen damage will occur if the projector is exposed to moisture, dust or smoke.
- Do not cover the vents on the projector. Proper ventilation is required to dissipate heat. Damage to the projector will occur if the vents are covered.

Mounting the projector

If you intend to mount your projector, we strongly recommend that you use a proper fitting BenQ projector mounting kit and that you ensure it is securely and safely installed.

If you use a non-BenQ brand projector mounting kit, there is a safety risk that the projector may fall down due to an improper attachment through the use of the wrong gauge or length screws.

Before mounting the projector

- Purchase a BenQ projector mounting kit from the place you purchased your BenQ projector.
- BenQ recommends that you also purchase a separate security cable and attach it securely to both the security bar on the projector and the base of the mounting bracket. This will perform the secondary role of restraining the projector should its attachment to the mounting bracket become loose.
- Ask your dealer to install the projector for you. Installing the projector on your own may cause it to fall and result in injury.
- Take necessary procedures to prevent the projector from falling off such as during an earthquake.
- The warranty doesn't cover any product damage caused by mounting the projector with a non-BenQ brand projector mounting kit.
- Consider the surrounding temperature where the projector is ceiling mounted. If a heater is used, the temperature around the ceiling may be higher than expected.
- Read the user manual for the mounting kit about the range of torque. Tightening with torque exceeding the recommended range may cause damage to the projector and subsequently falling off.
- Make sure the power outlet is at an accessible height so that you can easily shut down the projector.

Adjusting the projector position

Shifting the projection lens

The lens shift control provides flexibility for installing your projector. It allows the projector to be positioned off the center of the screen.

The lens shift is expressed as a percentage of the projected image height or width. You can turn the knobs on the projector to shift the projection lens in any direction within the allowable range depending on your desired image position.

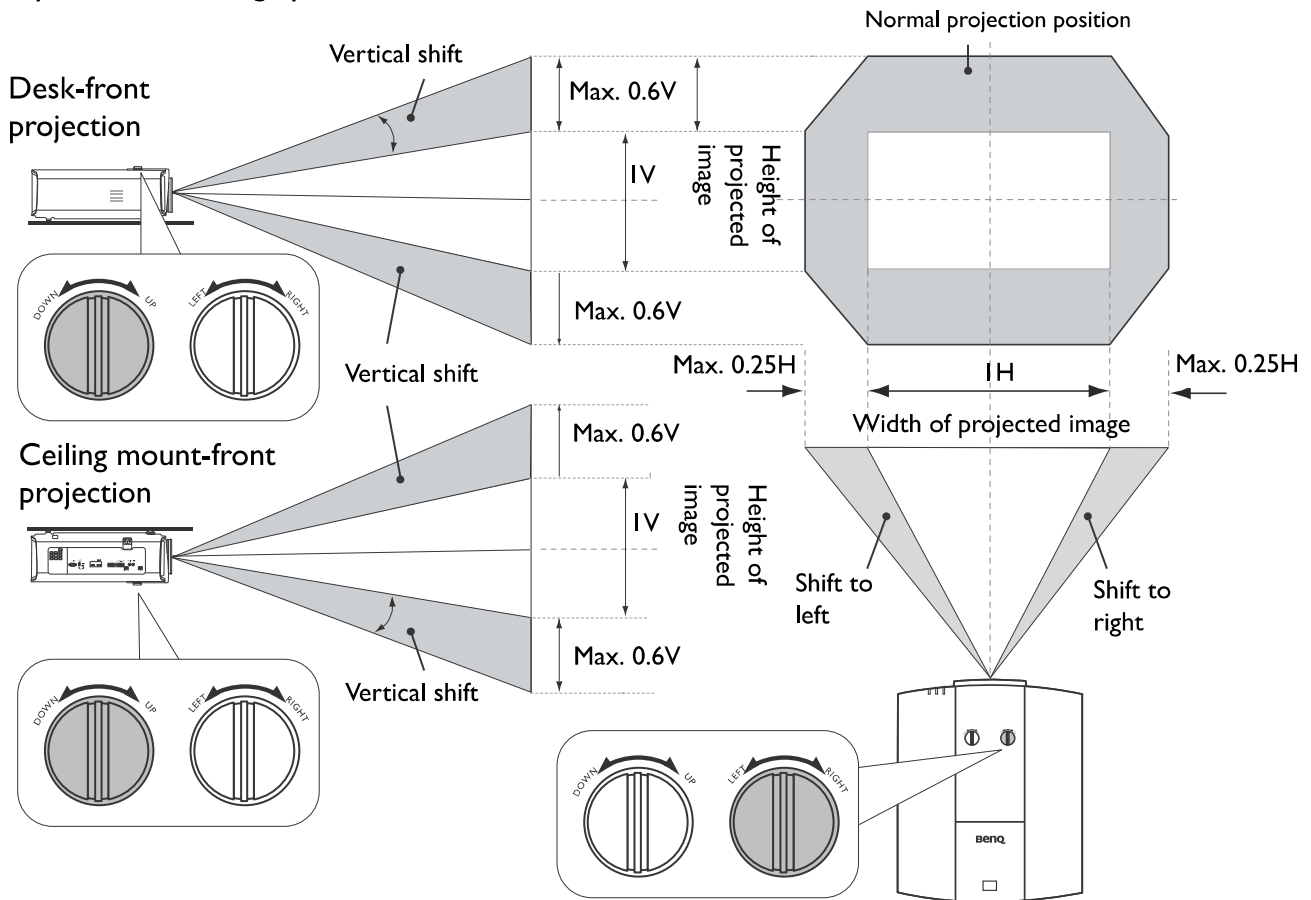

- Lens shift adjustment will not result in a degraded picture quality.
- Please stop turning the adjustment knob when you hear a clicking sound indicating that the knob has reached its limit. Over-turning the knob may cause damage.

Adjusting the projected image

Adjusting the projection angle

If the projector is not placed on a flat surface or the screen and the projector are not perpendicular to each other, the projected image becomes trapezoidal. You can screw the adjuster feet to fine-tune the horizontal angle.

To retract the feet, screw the adjuster feet in a reverse direction.

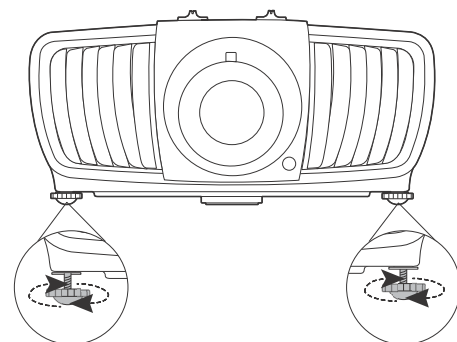

- Do not look into the lens while the light source is on. The strong light from the light source may cause damage to your eyes.

Fine-tuning the image size and clarity

1. Adjust the projected image to the size that you need using the zoom ring.
2. Sharpen the image by rotating the focus ring.

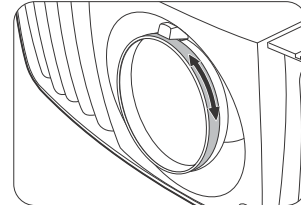
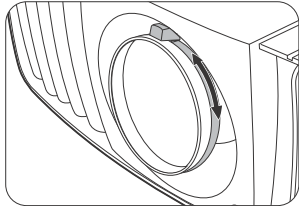
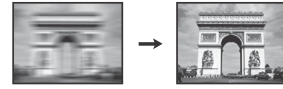

Using the lens rubber cap

When the projector is installed or mounted in any way other than a horizontal position, use the rubber cap to keep the zoom ring from rotating due to its own weight. After the focus and zoom rings are adjusted, follow the illustrations to insert the rubber cap to keep them in position.

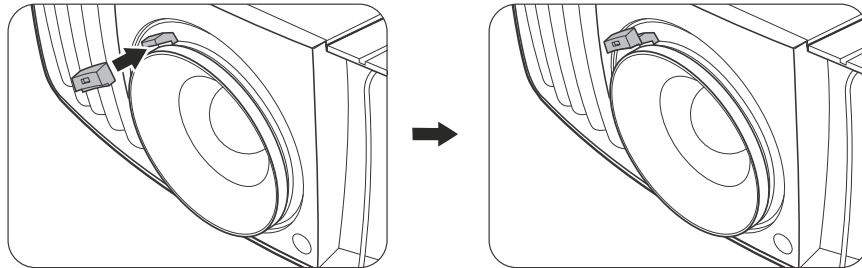

Connection

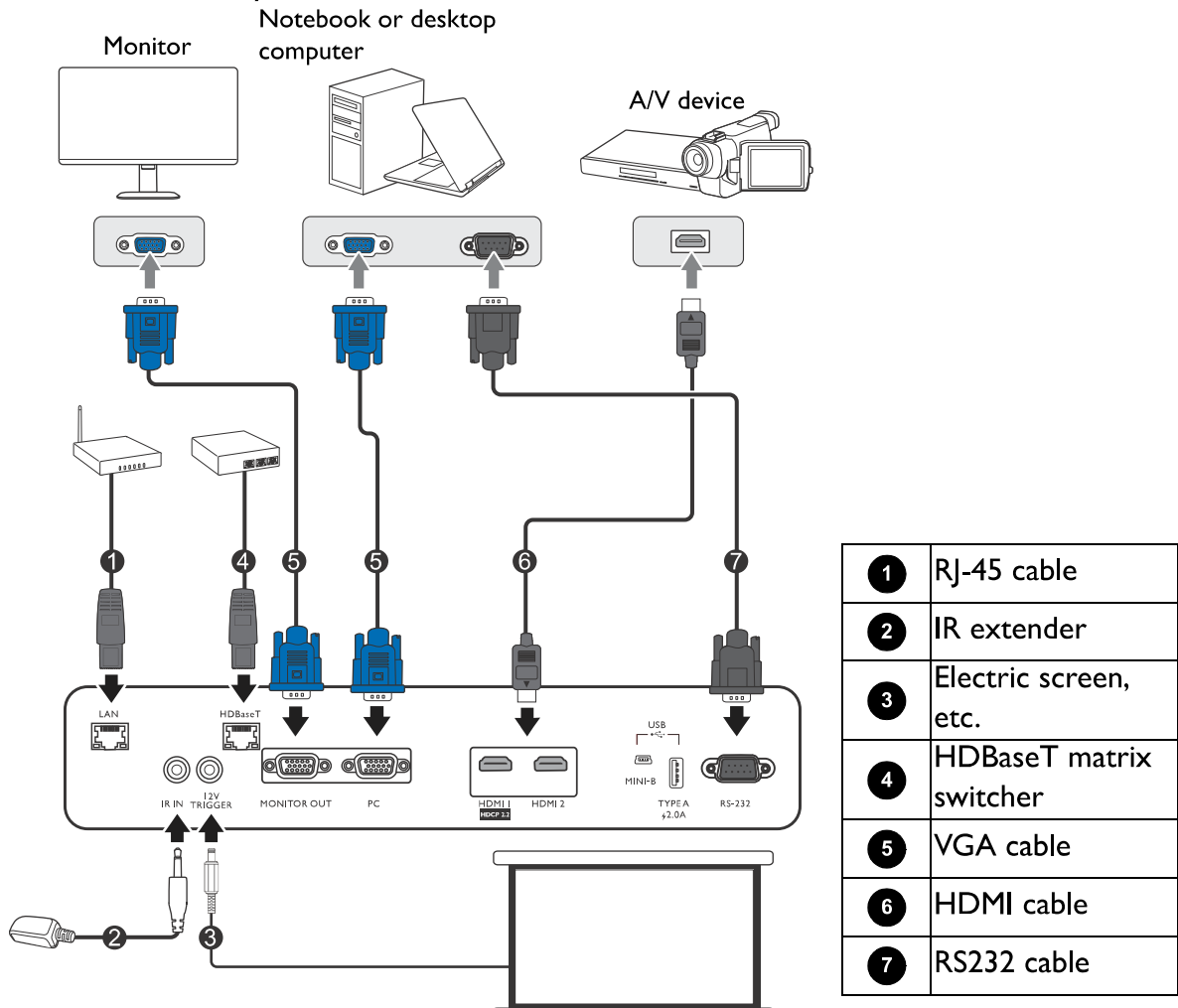

Before connecting, carefully read the operating instructions for connecting the external device. When connecting a signal source to the projector, be sure to:

1. Turn all equipment off before making any connections.
2. Use the correct signal cables for each source.
3. Ensure the cables are firmly inserted.

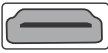

- In the connections above, some cables may not be included with the projector (see [Shipping contents on page 6](#)). They are commercially available from electronics stores.
- The connection illustrations are for reference only.
- Before connecting a cable to the projector or to a device that is connected to the projector, touch any nearby metallic objects to remove any static electricity from your body.
- Do not use unnecessarily long cables to connect the projector or a device to the projector. Using a longer cable that is wound makes it act like an antenna, making it more susceptible to noise.
- When connecting cables, connect GND first and then insert the connecting terminal of the connecting device.
- Many notebooks do not turn on their external video ports when connected to a projector. Usually a key combo like FN + function key with a monitor symbol turns the external display on/off. Press FN and the labeled function key simultaneously. Refer to your notebook's documentation to find your notebook's key combination.
- If the selected video image is not displayed after the projector is turned on and the correct video source has been selected, check that the video source device is turned on and operating correctly. Also check that the signal cables have been connected correctly.

You need only connect the projector to a video source device using just one of the connecting methods, however each provides a different level of video quality.

Terminal		Picture quality
HDMI 1 (Version 2.0)		Best
HDMI 2 (Version 1.4a)		Better
PC		Good

Using the cable tie set

The cable tie set helps prevent a cable plug from falling out of the connecting port. It contains the following parts.

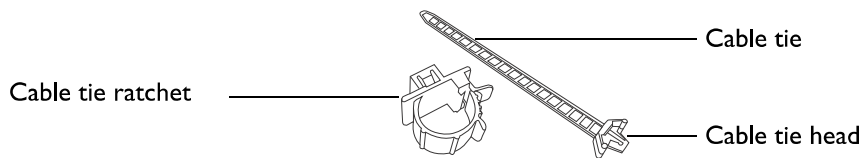

To use the cable tie set:

1. Firmly plug a cable to a correct port on the projector. Insert the cable tie head to the cable tie hole right above the connecting port. Note that the cable tie cannot be removed from the hole once it is inserted.

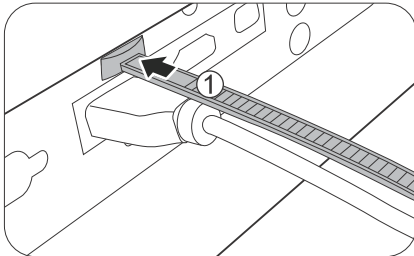

2. Take the cable tie ratchet. Slightly open the ratchet to surround the connecting cable.

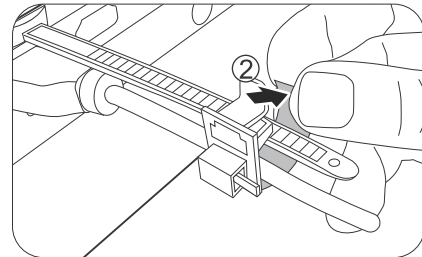

3. Insert the end of the cable tie to the cable tie ratchet as illustrated.
4. Close the cable tie ratchet by pressing its tab.

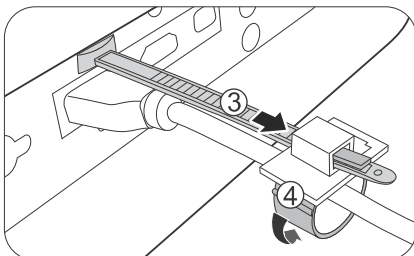

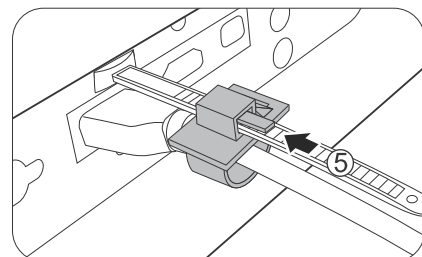

5. Move the cable tie ratchet along with the cable tie to the end of the cable plug.



The cable tie installation is done.





Operation

Starting up the projector

1. Plug the power cord. Turn on the power outlet switch (where fitted). The power indicator on the projector lights orange after power has been applied.
2. Press  on the projector or  on the remote control to start the projector. The power indicator flashes green and stays green when the projector is on.

The start up procedure takes about 30 seconds. In the later stage of start up, a startup logo is projected.

(If necessary) Rotate the focus ring to adjust the image clearness.

3. If this is the first time you turn on the projector, the setup wizard appears to guide you through setting up the projector. If you have already done this, skip this step and move on to the next step.
 - Use the arrow keys (/ / / ) on the projector or remote control to move through the menu items.
 - Use **OK** to confirm the selected menu item.

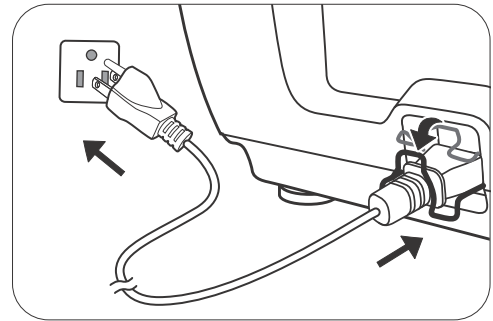

Step 1:

Specify **Projector Position**.

For more information about projector position, see [Choosing a location](#).

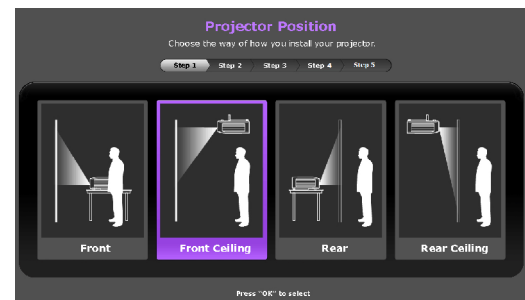

Step 2:

Specify OSD **Language**.



Step 3:

Specify **Auto Source**.

Select **On** if you want the projector to always search for available signals automatically when the projector is turned on.

Now you've completed the initial setup.

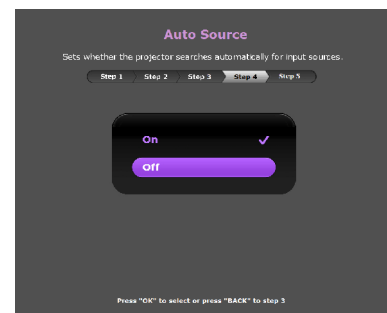

4. If you are prompted for a password, press the arrow keys to enter a 6-digit password. See [Utilizing the password function on page 21](#).
5. Switch all of the connected equipment on.
6. The projector will search for input signals. The current input signal being scanned appears. If the projector does not detect a valid signal, the message “No Signal” will continue displaying until an input signal is found.

You can also press **SOURCE** to select your desired input signal. See [Switching input signal on page 22](#).



- Please use the original accessories (e.g. power cord) to avoid possible dangers such as electric shock and fire.
- The Setup Wizard screenshots are for reference only and may differ from the actual design.
- If the frequency/resolution of the input signal exceeds the projector's operating range, you will see the message “Out of Range” displayed on the background screen. Please change to an input signal which is compatible with the projector's resolution or set the input signal to a lower setting. See [Timing chart on page 40](#).
- If no signal is detected for 3 minutes, the projector automatically enters saving mode.

Using the menus

The projector is equipped with On-Screen Display (OSD) menus for making various adjustments and settings.



The OSD screenshots below are for reference only, and may differ from the actual design.

Below is the overview of the OSD menu.

	<p>① Main menu icon</p> <p>② Main menu</p> <p>③ Sub-menu</p>	<p>④ Current input signal</p> <p>⑤ Status</p> <p>⑥ Press BACK to go to the previous page or to exit.</p>
--	--	---

To access the OSD menu, press **MENU** on the projector or remote control.

- Use the arrow keys (▲/▼/◀/▶) on the projector or remote control to move through the menu items.
- Use **OK** on the projector or remote control to confirm the selected menu item.

Securing the projector

Using a security cable lock

The projector has to be installed in a safe place to prevent theft. Otherwise, purchase a lock, such as the Kensington lock or security cable, to secure the projector. You can locate or a security bar on the projector. See item 13 on [page 7](#).

Utilizing the password function

Setting a password

1. Go to **SYSTEM SETUP: ADVANCED > Password**. Press **OK**. The **Password** page appears.
2. Highlight **Change Password** and press **OK**.
3. The four arrow keys (▲, ►, ▼, ◀) respectively represent 4 digits (1, 2, 3, 4). According to the password you desire to set, press the arrow keys to enter six digits for the password.
4. Confirm the new password by re-entering the new password.
Once the password is set, the OSD menu returns to the **Password** page.
5. To activate the **Power On Lock** function, press ▲/▼ to highlight **Power On Lock** and press ◀/▶ to select **On**. Input the password again.

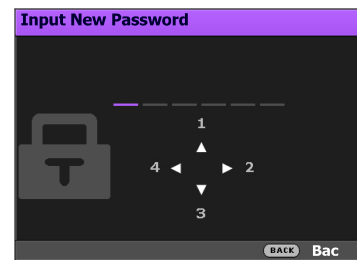

- The digits being input will display as asterisks on-screen. Make a note of your selected password and keep it in a safe place in advance or right after the password is entered so that it is available to you should you ever forget it.
- Once a password has been set and the power on lock is activated, the projector cannot be used unless the correct password is entered every time the projector is started.

If you forget the password

If you enter the wrong password, the password error message will appear, and the **Input Current Password** message follows. If you absolutely do not remember the password, you can use the password recall procedure. See [Entering the password recall procedure on page 21](#).

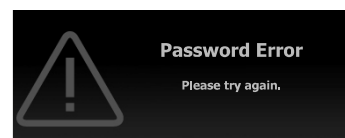

If you enter an incorrect password 5 times in succession, the projector will automatically shut down in a short time.

Entering the password recall procedure

1. Press and hold **OK** for 3 seconds. The projector will display a coded number on the screen.
2. Write down the number and turn off your projector.
3. Seek help from the local BenQ service center to decode the number. You may be required to provide proof of purchase documentation to verify that you are an authorized user of the projector.

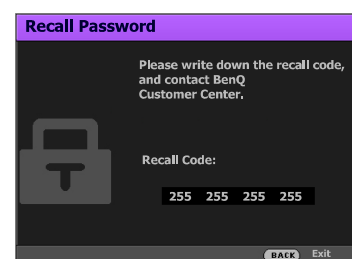

Changing the password

1. Go to **SYSTEM SETUP: ADVANCED > Password > Change Password**.
2. Press **OK**. The message “**Input Current Password**” appears.
3. Enter the old password.
 - If the password is correct, another message “**Input New Password**” appears.
 - If the password is incorrect, the password error message will appear, and the message “**Input Current Password**” appears for your retry. You can press **BACK** to cancel the change or try another password.
4. Enter a new password.
5. Confirm the new password by re-entering the new password.

Disabling the password function

To disable password protection, go to **SYSTEM SETUP: ADVANCED > Password > Power On Lock** and press **◀/▶** to select **Off**. The message “**Input Current Password**” appears. Enter the current password.

- If the password is correct, the OSD menu returns to the **Password** page. You will not have to enter the password next time turning on the projector.
- If the password is incorrect, the password error message will appear, and the message “**Input Current Password**” appears for your retry. You can press **BACK** to cancel the change or try another password.



Though the password function is disabled, you need to keep the old password in hand should you ever need to re-activate the password function by entering the old password.

Switching input signal

The projector can be connected to multiple devices at the same time. However, it can only display one full screen at a time. When starting up, the projector automatically searches for the available signals.

Be sure the **SYSTEM SETUP: BASIC > Auto Source** menu is **On** if you want the projector to automatically search for the signals.

To select the source:

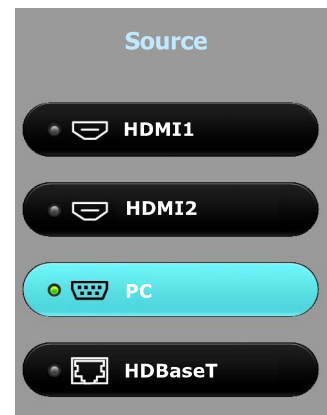

1. Press **SOURCE**. A source selection bar appears.
2. Press **▲/▼** until your desired signal is selected and press **OK**.

Once detected, the selected source information will appear at the corner of the screen for seconds. If there is multiple equipment connected to the projector, repeat steps 1-2 to search for another signal.



- The brightness level of the projected image will change accordingly when you switch between different input signals.
- For best display picture results, you should select and use an input signal which outputs at the projector's native resolution. Any other resolutions will be scaled by the projector depending upon the “aspect ratio” setting, which may cause some image distortion or loss of picture clarity. See [Aspect Ratio on page 29](#).

Shutting down the projector

1. Press  and a confirmation message will appear prompting you. If you don't respond in a few seconds, the message will disappear.
2. Press  a second time. The **POWER indicator light** flashes orange, the projection light source shuts down.
3. Once the cooling process finishes, the **POWER indicator light** is a steady orange and fans stop. Disconnect the power cord from the power outlet.

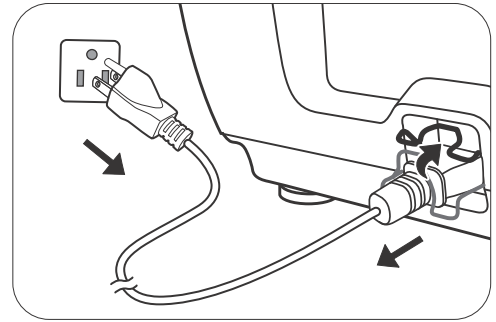

- To protect the light source, the projector will not respond to any commands during the cooling process.

- Press  again to start the projector after the **POWER indicator light** turns a steady orange.

Menu operation

Please note that the on-screen display (OSD) menus vary according to the signal type selected and the projector model you are using.

The menu items are available when the projector detects at least one valid signal. If there is no equipment connected to the projector or no signal detected, limited menu items are accessible.

PICTURE menu

<p>Picture Mode</p>	<p>The projector is preset with several predefined picture modes so that you can choose one to suit your operating environment and input signal picture type.</p> <ul style="list-style-type: none"> • Bright: Maximizes the brightness of the projected image. This mode is suitable for environments where extra-high brightness is required, such as using the projector in well lit rooms. • PRESN: Is designed for presentations. The brightness is emphasized in this mode to match PC and notebook coloring. • sRGB: Maximizes the purity of RGB colors to provide true-to-life images regardless of brightness setting. It is most suitable for viewing photos taken with an sRGB compatible and properly calibrated camera, and for viewing PC graphic and drawing applications such as AutoCAD. • Cinema: With well-balanced color saturation and contrast with a low brightness level, this is most suitable for enjoying movies in a totally dark environment (as you would find in a commercial cinema). • DICO-S: Follows the standard of DICOM to get the gray level parameter. • User 1/User 2: Recalls the settings customized based on the current available picture modes. See User Mode Management on page 24. • ISF Day/ISF Night: Only available when ISF is On.
<p>User Mode Management</p>	<p>There are two user-definable modes if the current available picture modes are not suitable for your need. You can use one of the picture modes (except the User 1/User 2) as a starting point and customize the settings.</p> <ul style="list-style-type: none"> • Load Settings From <ol style="list-style-type: none"> 1. Go to PICTURE > Picture Mode. 2. Press ◀/▶ to select User 1 or User 2. 3. Press ▼ to highlight User Mode Management, and press OK. The User Mode Management page is displayed. 4. Select Load Settings From and press OK. 5. Press ▼/▲ to select a picture mode that is closest to your need. 6. Press OK and BACK to return to the PICTURE menu. 7. Press ▼ to select the sub-menu items you want to change and adjust the values with ◀/▶. The adjustments define the selected user mode.

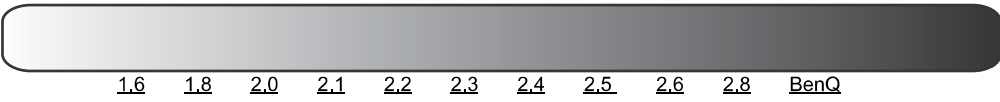
<p>User Mode Management (Continued)</p>	<p>• Rename User Mode</p> <p>Select to rename the customized picture modes (User 1 or User 2). The new name can be up to 9 characters including English letters (A-Z, a-z), digits (0-9), and space ().</p> <ol style="list-style-type: none"> 1. Go to PICTURE > Picture Mode. 2. Press ◀/▶ to select User 1 or User 2. 3. Press ▼ to highlight User Mode Management, and press OK. The User Mode Management page is displayed. 4. Press ▼ to highlight Rename User Mode and press OK. The Rename User Mode page is displayed. 5. Use ▲/▶/▼/◀ to select desired characters. 6. When done, press OK and BACK to exit.
<p>Brightness</p>	<p>The higher the value, the brighter the image. Adjust this control so the black areas of the image appear just as black and that detail in the dark areas is visible.</p>
<p>Contrast</p>	<p>The higher the value, the greater the contrast. Use this to set the peak white level after you have previously adjusted the Brightness setting to suit your selected input and viewing environment.</p>
<p>Color</p>	<p>Lower setting produces less saturated colors. If the setting is too high, colors on the image will be overpowering, which makes the image unrealistic.</p>
<p>Tint</p>	<p>The higher the value, the more greenish the picture becomes. The lower the value, the more reddish the picture becomes.</p>
<p>Sharpness</p>	<p>The higher the value, the sharper the picture becomes.</p>
<p>Advanced</p>	<p>• Gamma Selection</p> <p>Gamma refers to the relationship between input source and picture brightness.</p> <ul style="list-style-type: none"> • 1.6/1.8/2.0/2.1/BenQ: Select these values according to your preference. • 2.2/2.3: Increases the average brightness of the picture. Best for a lit environment, meeting room or family room. • 2.4/2.5: Best for viewing movies in a dark environment. • 2.6/2.8: Best for viewing movies which are mostly composed of dark scenes. <div style="display: flex; justify-content: space-between; align-items: center; margin-top: 10px;"> <div style="text-align: center;"> <p>High Brightness Low Contrast</p> </div> <div style="text-align: center;"> <p>Low Brightness High Contrast</p> </div> </div>  <p style="text-align: center; margin-top: 5px;"> 1.6 1.8 2.0 2.1 2.2 2.3 2.4 2.5 2.6 2.8 BenQ </p>

• **Color Temperature**

- **Preset:** There are several preset color temperature settings available. The available settings may vary according to the signal type selected.

Normal	Maintains normal colorings for white.
Cool	Makes images appear bluish white.
Lamp Native	With the light source's original color temperature and higher brightness. This setting is suitable for environments where high brightness is required, such as projecting pictures in well lit rooms.
Warm	Makes images appear reddish white.

You can also set a preferred color temperature by adjusting the following options.

- **R Gain/G Gain/B Gain:** Adjusts the contrast levels of Red, Green, and Blue.
- **R Offset/G Offset/B Offset:** Adjusts the brightness levels of Red, Green, and Blue.

• **Color Management**

The Color Management provides six sets (RGBCMY) of colors to be adjusted. When you select each color, you can independently adjust its range and saturation according to your preference.

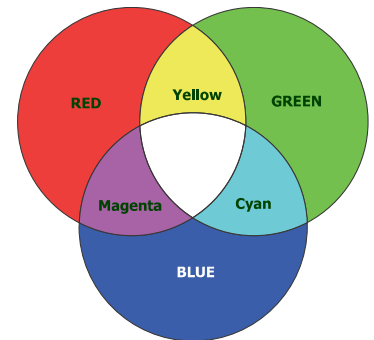

- **Primary Color:** Selects a color from among Red, Yellow, Green, Cyan, Blue, or Magenta.
- **Hue:** Increase in the range will include colors consisted of more proportions of its two adjacent colors. Please refer to the illustration for how the colors relate to each other. For example, if you select Red and set its range at 0, only pure red in the projected picture will be selected. Increasing its range will include red close to yellow and red close to magenta.
- **Gain:** Adjusts the values to your preference. The contrast level of the primary color you select will be affected. Every adjustment made will reflect to the image immediately.
- **Saturation:** Adjusts the values to your preference. Every adjustment made will reflect to the image immediately. For example, if you select Red and set its value at 0, only the saturation of pure red will be affected.



Saturation is the amount of that color in a video picture. Lower settings produce less saturated colors; a setting of “0” removes that color from the image entirely. If the saturation is too high, that color will be overpowering and unrealistic.

<p>Advanced (Continued)</p>	<ul style="list-style-type: none"> • CinemaMaster <ul style="list-style-type: none"> • Color Enhancer: Allows you to fine-tune the saturation of colors with larger flexibility. It modulates complex color algorithms to flawlessly render saturated colors, fine gradients, intermediate hues and subtle pigments. • Flesh Tone: Provides a smart adjustment of hue only for calibrating people's skin color, not other colors in the image. It prevents discoloration of skin tones from the light of the projection beam, portraying every skin tone in its most beautiful shade. • Pixel Enhancer 4K: It is a super-resolution technology which radically enhances Full HD content in terms of colors, contrast, and textures. It's also a Detail Enhancement Technology refines surface details for true-to-life images that pop off the screen. Users can adjust levels of sharpness and detail enhancement for optimal viewing. • DCTI/DLTI: Sophisticated algorithms significantly improve color and light output when producing images with contrasting colors or bright and dark scales. DCTI heightens color vibrancy for drastic color transitions without noise interference. DLTI reduces noise from fast switching of varied luminance to optimized brightness and contrast. The result is picture quality with the utmost picture depth and color performance. • Noise Reduction: Reduces electrical image noise caused by different media players. The higher the value, the less the noise. • Light Source Mode: Selects a suitable light source power from among the provided modes. See Setting the Light Source Mode on page 34.
<p>Reset Current Picture Mode</p>	<p>Returns all of the adjustments you've made for the selected Picture Mode (including preset modes, User 1, and User 2) to the factory preset values.</p> <ol style="list-style-type: none"> 1. Press OK. The confirmation message is displayed. 2. Use ◀/▶ to select Reset and press OK. The current picture mode returns to the factory preset settings.

DISPLAY menu

Image Position	Displays the position adjustment page. To move the projected image, use the directional arrow keys. This function is only available when a PC signal (analog RGB) is selected.
Overscan Adjustment	Conceals the poor picture quality in the four edges. The greater the value, the more portion of the picture is concealed while the screen remains filled and geometrically accurate. Setting 0 means the picture is 100% displayed.
PC Tuning	<ul style="list-style-type: none"> • H. Size: Adjusts the horizontal width of the image. • Phase: Adjusts the clock phase to reduce image distortion. • Auto: Adjusts the phase and frequency automatically.   <p>These functions are only available when the PC signal is selected.</p>

INSTALLATION menu

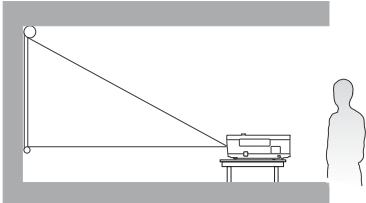
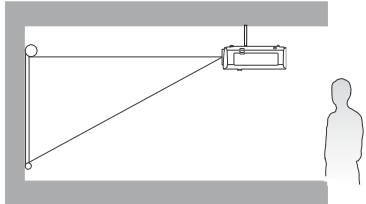
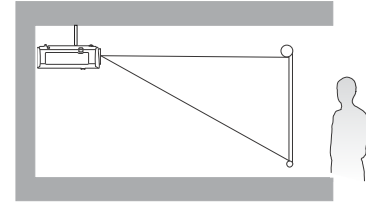
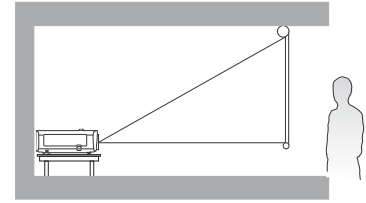
Projector Position	<ul style="list-style-type: none"> • Front Table Select this location with the projector placed on the table in front of the screen. This is the most common way to position the projector for quick setup and portability. • Front Ceiling Select this location with the projector suspended upside-down from the ceiling in front of the screen. Purchase the BenQ Projector Ceiling Mount Kit from your dealer to mount your projector on the ceiling. • Rear Ceiling Select this location with the projector suspended upside-down from the ceiling behind the screen. Note that a special rear projection screen and the BenQ Projector Ceiling Mount Kit are required for this installation location. • Rear Table Select this location with the projector placed on the table behind the screen. Note that a special rear projection screen is required.    
---------------------------	---

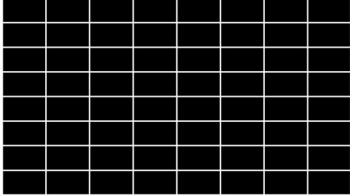
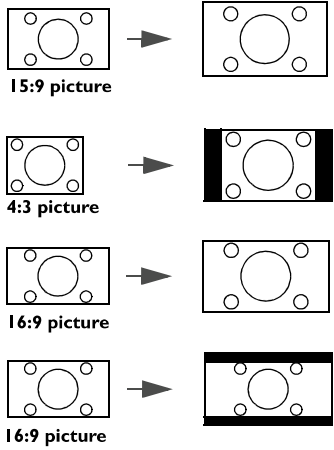
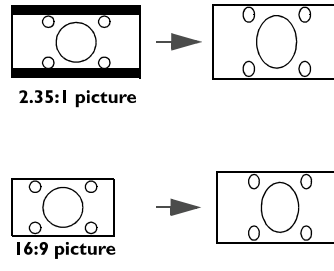

<p>Test Pattern</p>	<p>Adjusts the image size and focus and check that the projected image is free from distortion.</p> 
<p>Aspect Ratio</p>	<p>There are several options to set the image's aspect ratio depending on your input signal source.</p> <ul style="list-style-type: none"> • Auto: Scales an image proportionally to fit the projector's native resolution in its horizontal or vertical width. • 4:3: Scales an image so that it is displayed in the center of the screen with a 4:3 aspect ratio. • 16:9: Scales an image so that it is displayed in the center of the screen with a 16:9 aspect ratio. • 2.35:1: Scales an image so that it is displayed in the center of the screen with a 2.35:1 aspect ratio. 
<p>Aspect Ratio (Continued)</p>	<ul style="list-style-type: none"> • Anamorphic 2.35:1: Vertically stretches an image to fit the anamorphic lens. It keeps the native resolution in its horizontal width and resizes the resolution in its vertical height to 1.32 times of the original image. • Anamorphic 16:9: Horizontally squeezes an image to fit the anamorphic lens. It keeps the native resolution in its vertical height and resizes the resolution in its horizontal width to 0.75 times of the original image. 
<p>12V Trigger</p>	<p>There are two 12V triggers that work independently according to your needs for installation scenarios. Three selections are available:</p> <ul style="list-style-type: none"> • Off: If this is selected, the projector will not send electronic signal out when it is turned on. • Power: The projector will send a low to high electronic signal out when it is turned on, a high to low signal out when it is turned off. • Anamorphic: The projector will send a low to high electronic signal out when the aspect ratio is switched from other aspect ratios to "Anamorphic 2.35:1" or "Anamorphic 16:9", a high to low signal out when the aspect ratio setting is switched from "Anamorphic 2.35:1" or "Anamorphic 16:9" to other aspect ratios.



High Altitude Mode	<p>We recommend you use the High Altitude Mode when your environment is between 1500 m –3000 m above sea level, and ambient temperature is between 0°C–30°C.</p> <p>Operation under "High Altitude Mode" may cause a higher decibel operating noise level because of increased fan speed necessary to improve overall system cooling and performance.</p> <p>If you use this projector under other extreme conditions excluding the above, it may display auto shut-down symptoms, which is designed to protect your projector from over-heating. In cases like this, you should switch to High Altitude mode to solve these symptoms. However, this is not to state that this projector can operate under any and all harsh or extreme conditions.</p>  <p>Do not use the High Altitude Mode if your altitude is between 0 m and 1499 m and ambient temperature is between 0°C and 35°C. The projector will be over cooled, if you turn the mode on under such a condition.</p>
---------------------------	--

SYSTEM SETUP: BASIC menu

Language	Sets the language for the On-Screen Display (OSD) menus.
Background Color	Sets the background color for the projector.
Splash Screen	Allows you to select which logo screen will be displayed during projector start-up.
Auto Off	Allows the projector to turn off automatically if no input signal is detected after a set period of time to prevent unnecessary waste of light source life.
Direct Power On	Allows the projector to turn on automatically once the power is fed through the power cord.
Menu Settings	<ul style="list-style-type: none"> • Menu Position: Sets the On-Screen Display (OSD) menu position. • Menu Display Time: Sets the length of time the OSD will remain active after your last key press. • Reminder Message: Sets the reminder messages on or off.
Source Rename	<p>Renames the current input source to your desired name.</p> <p>On the Source Rename page, use ▲/▼/◀/▶ to set the desired characters for the connected source item.</p> <p>When done, press OK to save the changes.</p>
Auto Source	Allows the projector to automatically search for a signal.

SYSTEM SETUP: ADVANCED menu

<p>Light Source Information</p>	<ul style="list-style-type: none"> • Reset Light Source Timer <p>Use this function only when a new light source is installed. To reset the light source timer, highlight Reset Light Source Timer and press OK. A warning message is displayed. Highlight Reset and press OK. The light source time will be reset to “0”.</p>  <p>Do not reset if the light source is not new or replaced as this could cause damage.</p> <ul style="list-style-type: none"> • Light Source Timer: See Getting to know the light source hour on page 34. 						
<p>HDMI Settings</p>	<ul style="list-style-type: none"> • HDMI Range <p>Selects a suitable RGB color range to correct the color accuracy.</p> <ul style="list-style-type: none"> • Auto: Automatically selects a suitable color range for the incoming HDMI signal. • Full Range: Utilizes the Full range RGB 0-255. • Limited Range: Utilizes the Limited range RGB 16-235. <ul style="list-style-type: none"> • CEC <p>When you connect an HDMI CEC-compatible device to your projector with an HDMI cable, turning on the HDMI CEC compatible device automatically turns on the projector, while turning off the projector automatically turns off the HDMI CEC compatible device.</p> <ul style="list-style-type: none"> • Power On Link/Power Off Link <p>When you connect an HDMI CEC-compatible device to your projector with an HDMI cable, you can set the behavior of powering on/off between the device and the projector.</p> <table border="1" data-bbox="375 1272 1453 1514"> <tr> <td>Bidirectional</td> <td>Turning on/off either the connected device or the projector can turn on/off both.</td> </tr> <tr> <td>From Projector</td> <td>When the projector is turned on/off, the connected device will be activated/shut down, too.</td> </tr> <tr> <td>From Device</td> <td>When the connected device is turned on/off, the projector will be activated/shut down, too.</td> </tr> </table>	Bidirectional	Turning on/off either the connected device or the projector can turn on/off both.	From Projector	When the projector is turned on/off, the connected device will be activated/shut down, too.	From Device	When the connected device is turned on/off, the projector will be activated/shut down, too.
Bidirectional	Turning on/off either the connected device or the projector can turn on/off both.						
From Projector	When the projector is turned on/off, the connected device will be activated/shut down, too.						
From Device	When the connected device is turned on/off, the projector will be activated/shut down, too.						
<p>Password</p>	<p>See Utilizing the password function on page 21.</p>						
<p>Key Lock</p>	<p>With the control keys on the projector and remote control locked, you can prevent your projector settings from being changed accidentally (by children, for example). When the Key Lock is on, no control keys on the projector will operate except  POWER.</p> <p>To release panel key lock, press and hold ▶ (the right key) on the projector or remote control for 3 seconds.</p>  <p>If you turn off the projector without disabling panel key lock, the projector will still be in locked status the next time it is turned on.</p>						

LED Indicator	Selects to turn off the LED warning lights. This is to avoid any light disturbance when viewing images in a dark room.
Network Settings	<ul style="list-style-type: none"> • Wired LAN: See BenQ Network Projector Operation Guide. • AMX Device Discovery: When this function is On, the projector can be detected by AMX controller. • Network Standby: When this function is On, the projector is able to provide the network function when it is in standby mode. • MAC Address: Displays the mac address for this projector.
Standby HDBaseT Setting	When this function is On , the projector will automatically turns on when receives a RS232 or IR power on signal.
Serial Port Setting	Press ◀/▶ to select the serial port.
Reset All Settings	<p>Returns all settings to the factory preset values.</p>  <p>The following settings will still remain: Picture Mode, User Mode Management, Brightness, Contrast, Color, Tint, Sharpness, Advanced, Projector Position, Source Rename, Password, and Network Settings.</p>
ISF	<p>The ISF calibration menu is password protected and only accessible by authorized ISF calibrators. The ISF (Imaging Science Foundation) has developed carefully crafted, industry-recognized standards for optimal video performance and has implemented a training program for technicians and installers to use these standards to obtain optimal picture quality from BenQ video display devices. Accordingly, we recommend that setup and calibration be performed by an ISF certified installation technician.</p>  <p>For more information, go to www.imagingscience.com or contact the dealer or retailer from whom you purchased the projector.</p>

INFORMATION menu

Current System Status	<ul style="list-style-type: none"> • Source: Shows the current signal source. • Picture Mode: Shows the selected mode in the PICTURE menu. • Resolution: Shows the native resolution of the input signal. • Color System: Shows input system format. • Light Source Usage Time: Shows the number of hours the light source has been used. • Firmware Version: Shows the firmware version of your projector.
------------------------------	--

Maintenance

Care of the projector

Cleaning the lens

Clean the lens whenever you notice dirt or dust on the surface. Please be sure to turn off the projector and let it cool down completely before cleaning the lens.

- Use a canister of compressed air to remove dust.
- If there is dirt or smears, use lens-cleaning paper or moisten a soft cloth with lens cleaner and gently wipe the lens surface.
- Never use any type of abrasive pad, alkaline/acid cleaner, scouring powder, or volatile solvent, such as alcohol, benzene, thinner or insecticide. Using such materials or maintaining prolonged contact with rubber or vinyl materials may result in damage to the projector surface and cabinet material.

Cleaning the projector case

Before you clean the case, turn the projector off using the proper shutdown procedure as described in [Shutting down the projector on page 23](#) and unplug the power cord.

- To remove dirt or dust, wipe the case with a soft, lint-free cloth.
- To remove stubborn dirt or stains, moisten a soft cloth with water and a neutral pH detergent. Then wipe the case.



Never use wax, alcohol, benzene, thinner or other chemical detergents. These can damage the case.

Storing the projector

If you need to store the projector for an extended time, please follow the instructions below:

- Make sure the temperature and humidity of the storage area are within the recommended range for the projector. Please refer to [Specifications on page 37](#) or consult your dealer about the range.
- Retract the adjuster feet.
- Remove the battery from the remote control.
- Pack the projector in its original packing or equivalent.

Transporting the projector

It is recommended that you ship the projector with its original packing or equivalent.

Light source information

Getting to know the light source hour

When the projector is in operation, the duration (in hours) of light source usage is automatically calculated by the built-in timer. The method of calculating the equivalent light source hour is as follows:

$$\text{Light Source Usage Time} = (\text{hours used in Normal mode}) + (\text{hours used in Economic mode}) + (\text{hours used in Dimming mode}) + (\text{hours used in Custom mode})$$

$$\text{Total (equivalent) light source hour} = 1.0 \times (\text{hours used in Normal mode}) + 1.0 \times (\text{hours used in Economic mode}) + 1.0 \times (\text{hours used in Dimming mode}) + 1.0 \times (\text{hours used in Custom mode})$$

To obtain the light source hour information:

1. Go to **SYSTEM SETUP: ADVANCED > Light Source Information** and press **OK**. The **Light Source Information** page appears.
2. Press **▼** to select **Light Source Timer** and press **OK**. The **Light Source Timer** information is displayed.

You can also get the light source hour information on the **INFORMATION** menu.

Extending light source life

- Setting the **Light Source Mode**

Go to **PICTURE > Advanced > Light Source Mode** or press **LIGHT MODE** on the remote control to select a suitable light source power from among the provided modes.

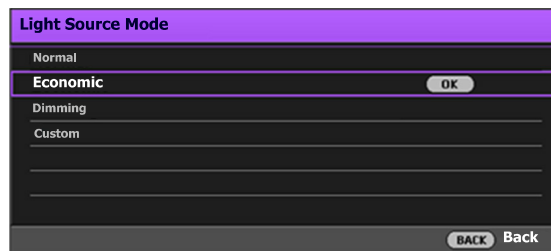

Light source mode	Description
Normal	Provides full light source brightness
Economic	Lowers brightness to extend the light source life and decreases the fan noise
Dimming	Lowers brightness to offer a longer light source life
Custom	Displays the light source brightness adjustment bar so that you can adjust the setting to your liking

- Setting **Auto Off**































































This function allows the projector to turn off automatically if no input signal is detected after a set period of time to prevent unnecessary waste of light source life.









To set **Auto Off**, go to **SYSTEM SETUP: BASIC > Auto Off** and press **◀/▶**.



- The apparent brightness of the projected image will vary depending on the ambient lighting conditions, selected input signal contrast/brightness settings, and is directly proportional to projection distance.
- The light source brightness will decline over time and may vary within the light source manufacturers specifications. This is normal and expected behavior.

LED Indicators

Light			Status & Description
POWER	TEMP	LIGHT	
Power events			
			Stand-by mode
			Powering up
			Normal operation
			Normal power-down cooling
			Downloading
			Colorwheel start fail
			Scaler reset fail
			Burn-in ON
			Burn-in OFF
Light source events			
			Light source I error in normal operation
Thermal events			
			Fan 1 error (the actual fan speed is outside the desired speed)
			Fan 2 error (the actual fan speed is outside the desired speed)
			Fan 3 error (the actual fan speed is outside the desired speed)
			Fan 4 error (the actual fan speed is outside the desired speed)
			Fan 5 error (the actual fan speed is outside the desired speed)
			Fan 6 error (the actual fan speed is outside the desired speed)
			Fan 7 error (the actual fan speed is outside the desired speed)
			Fan 8 error (the actual fan speed is outside the desired speed)
			Temperature 1 error (over limited temperature)
			Temperature 2 error (over limited temperature)
			Liquid in liquid cooler pump is insufficient

	 : Off	 : Orange On	 : Green On	 : Red On
		 : Orange Flashing	 : Green Flashing	 : Red Flashing

Troubleshooting

? The projector does not turn on.

Cause	Remedy
There is no power from the power cord.	Plug the power cord into the AC power jack on the projector, and plug the power cord into the power outlet. If the power outlet has a switch, make sure that it is switched on.
Attempting to turn the projector on again during the cooling process.	Wait until the cooling down process has completed.

? No picture

Cause	Remedy
The video source is not turned on or connected correctly.	Turn the video source on and check that the signal cable is connected correctly.
The projector is not correctly connected to the input signal device.	Check the connection.
The input signal has not been correctly selected.	Select the correct input signal with the SOURCE key.
The lens cover is still closed.	Open the lens cover.

? Blurred image

Cause	Remedy
The projection lens is not correctly focused.	Adjust the focus of the lens using the focus ring.
The projector and the screen are not aligned properly.	Adjust the projection angle and direction as well as the height of the projector if necessary.
The lens cover is still closed.	Open the lens cover.

? Remote control does not work.

Cause	Remedy
The batteries are out of power.	Replace both of the batteries with new ones.
There is an obstacle between the remote control and the projector.	Remove the obstacle.
You are too far away from the projector.	Stand within 8 meters (26 feet) of the projector.

? The password is incorrect.

Cause	Remedy
You do not remember the password.	See Entering the password recall procedure on page 21 .

Specifications

Projector specifications



All specifications are subject to change without notice.

Optical

Resolution

2716 (H) x 1528 (V)
4K UHD 3840X2160 on screen

Display system

1-CHIP DMD

Lens

F = 2.13 to 2.38, f = 20.58 to 30.30 mm

Clear focus range

2.89–6.09 m @ Wide,
4.25–8.96 m @ Tele

Light source

Laser diode

Electrical

Power supply

AC100–240V, 5.0 A, 50–60 Hz (Automatic)

Power consumption

595 W (Max); < 0.5 W (Standby)

Mechanical

Weight

19.20 Kg (42.3 lbs)

Output terminals

RGB output

D-Sub 15-pin (female) x 1

Control

RS-232 serial control

9 pin x 1

LAN control

RJ45 x 1

IR receiver x 2

Wired Remote control x 1

12V Trigger power supply 12V / 0.5A x 1

Input terminals

Computer input

RGB input

D-Sub 15-pin (female) x 1

Video signal input

Digital

HDMI (1.4b, HDCP 1.4) x 1;

HDMI (2.0, HDCP 2.2) x 1

USB

Mini Type B x 1; Type-A power supply 5V / 2 A x 1

HDBaseT RX x 1

Environmental Requirements

Operating temperature

0°C–40°C at sea level

Storage temperature

-20°C–60°C at sea level

Operating/Storage relative humidity

10%–90% (without condensation)

Operating altitude

0–1499 m at 0°C–35°C

1500–3000 m at 0°C–30°C (with

High Altitude Mode on)

Dimensions

470.7 mm (W) x 224.9 mm (H) x 564.7 mm (D)

Unit: mm

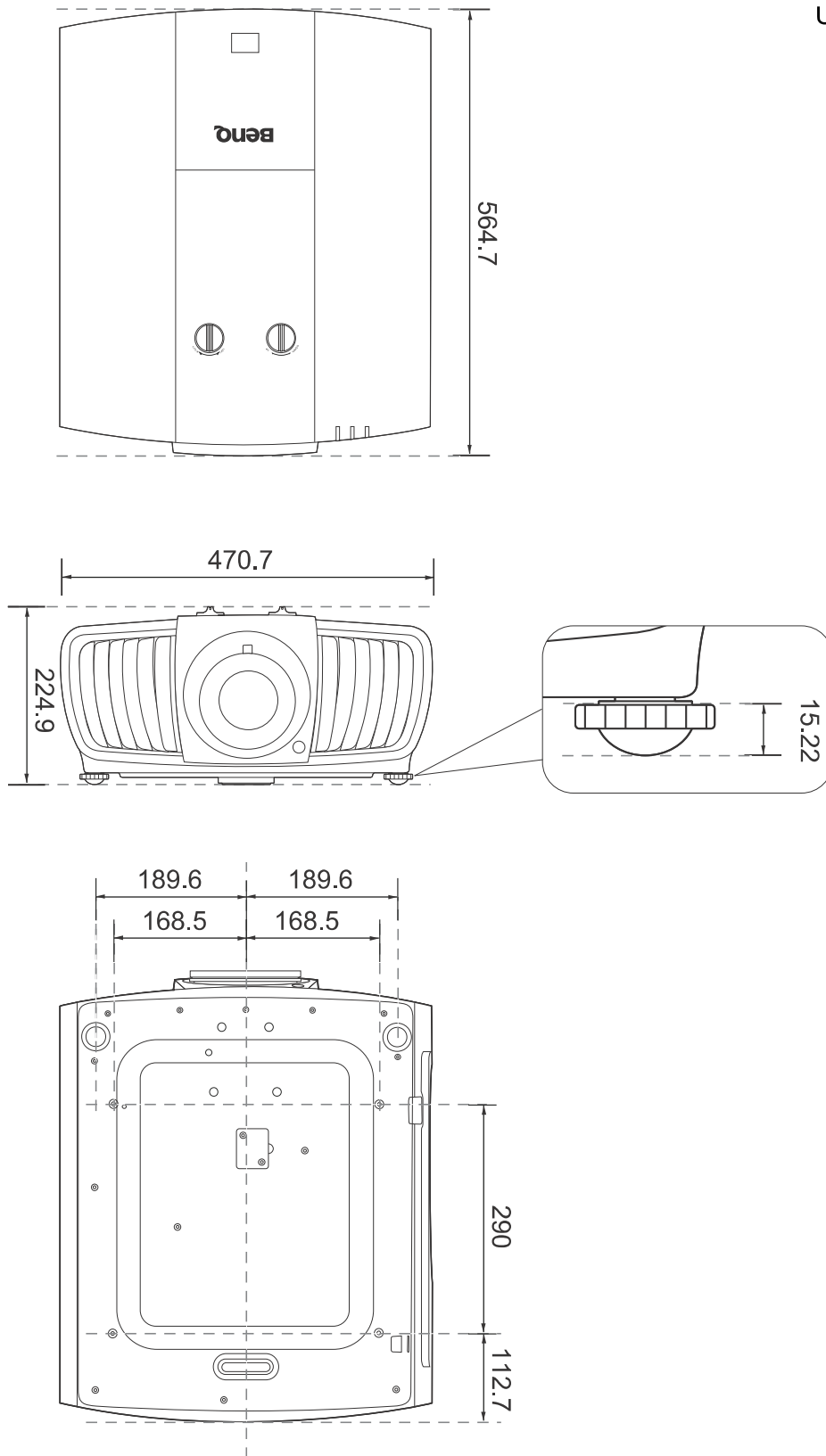

Ceiling mount installation diagram

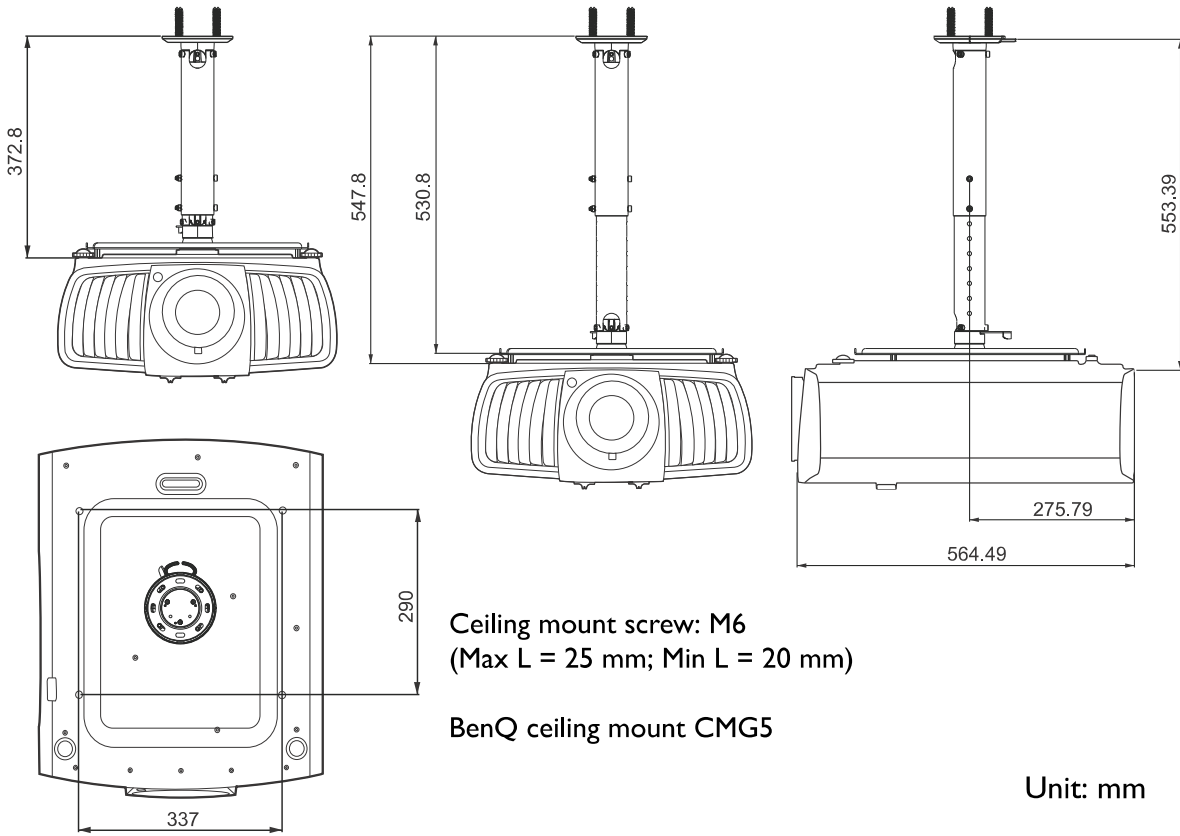

Timing chart

Supported timing for PC input

Resolution	Mode	Vertical Frequency (Hz)	Horizontal Frequency (kHz)	Pixel Frequency (MHz)
720 x 400	720 x 400_70	70.087	31.469	28.3221
640 x 480	VGA_60	59.940	31.469	25.175
	VGA_72	72.809	37.861	31.500
	VGA_75	75.000	37.500	31.500
	VGA_85	85.008	43.269	36.000
800 x 600	SVGA_60	60.317	37.879	40.000
	SVGA_72	72.188	48.077	50.000
	SVGA_75	75.000	46.875	49.500
	SVGA_85	85.061	53.674	56.250
	SVGA_120 (Reduce Blanking)	119.854	77.425	83.000
1024 x 768	XGA_60	60.004	48.363	65.000
	XGA_70	70.069	56.476	75.000
	XGA_75	75.029	60.023	78.750
	XGA_85	84.997	68.667	94.500
	XGA_120 (Reduce Blanking)	119.989	97.551	115.500
1152 x 864	1152 x 864_75	75.00	67.500	108.000
1024 x 576	BenQ NB Timing	60.0	35.820	46.966
1024 x 600	BenQ NB Timing	64.995	41.467	51.419
1280 x 720	1280 x 720_60	60	45.000	74.250
1280 x 768	1280 x 768_60	59.870	47.776	79.5
1280 x 800	WXGA_60	59.810	49.702	83.500
	WXGA_75	74.934	62.795	106.500
	WXGA_85	84.880	71.554	122.500
	WXGA_120 (Reduce Blanking)	119.909	101.563	146.25
1280 x 1024	SXGA_60	60.020	63.981	108.000
	SXGA_75	75.025	79.976	135.000
	SXGA_85	85.024	91.146	157.500
1280 x 960	1280 x 960_60	60.000	60.000	108
	1280 x 960_85	85.002	85.938	148.500
1360 x 768	1360 x 768_60	60.015	47.712	85.500
1440 x 900	WXGA+_60	59.887	55.935	106.500
1400 x 1050	SXGA+_60	59.978	65.317	121.750
1600 x 1200	UXGA	60.000	75.000	162.000
1680 x 1050	1680 x 1050_60	59.954	65.290	146.250
640 x 480@67Hz	MAC13	66.667	35.000	30.240
832 x 624@75Hz	MAC16	74.546	49.722	57.280
1024 x 768@75Hz	MAC19	74.93	60.241	80.000
1152 x 870@75Hz	MAC21	75.06	68.68	100.00
1920 x 1080@60Hz	1920 x 1080_60	60	67.5	148.5
1920 x 1200@60Hz	1920 x 1200_60 (Reduce Blanking)	59.95	74.038	154
1920 x 1080 (VESA)	1920 x 1080_60 (for Auditorium model)	59.963	67.158	173



The timings showing above may not be supported due to EDID file and VGA graphic card limitations. It is possible that some timings cannot be chosen.

Supported timing for HDMI (HDCP) input

- PC timings

Resolution	Mode	Vertical Frequency (Hz)	Horizontal Frequency (kHz)	Pixel Frequency (MHz)
640 x 480	VGA_60	59.940	31.469	25.175
	VGA_72	72.809	37.861	31.500
	VGA_75	75.000	37.500	31.500
	VGA_85	85.008	43.269	36.000
720 x 400	720 x 400_70	70.087	31.469	28.3221
800 x 600	SVGA_60	60.317	37.879	40.000
	SVGA_72	72.188	48.077	50.000
	SVGA_75	75.000	46.875	49.500
	SVGA_85	85.061	53.674	56.250
	SVGA_120 (Reduce Blanking)	119.854	77.425	83.000
1024 x 768	XGA_60	60.004	48.363	65.000
	XGA_70	70.069	56.476	75.000
	XGA_75	75.029	60.023	78.750
	XGA_85	84.997	68.667	94.500
	XGA_120 (Reduce Blanking)	119.989	97.551	115.500
1152 x 864	1152 x 864_75	75.00	67.500	108.000
1024 x 576	BenQ Notebook Timing	60.00	35.820	46.996
1024 x 600	BenQ Notebook Timing	64.995	41.467	51.419
1280 x 720	1280 x 720_60	60	45.000	74.250
1280 x 768	1280 x 768_60	59.870	47.776	79.5
1280 x 800	WXGA_60	59.810	49.702	83.500
	WXGA_75	74.934	62.795	106.500
	WXGA_85	84.880	71.554	122.500
	WXGA_120 (Reduce Blanking)	119.909	101.563	146.25
1280 x 1024	SXGA_60	60.020	63.981	108.000
	SXGA_75	75.025	79.976	135.000
	SXGA_85	85.024	91.146	157.500
1280 x 960	1280 x 960_60	60.000	60.000	108
	1280 x 960_85	85.002	85.938	148.500
1360 x 768	1360 x 768_60	60.015	47.712	85.500
1440 x 900	WXGA+_60	59.887	55.935	106.500
1400 x 1050	SXGA+_60	59.978	65.317	121.750
1600 x 1200	UXGA	60.000	75.000	162.000
1680 x 1050	1680 x 1050_60	59.954	65.290	146.250
640 x 480@67Hz	MAC13	66.667	35.000	30.240
832 x 624@75Hz	MAC16	74.546	49.722	57.280
1024 x 768@75Hz	MAC19	75.020	60.241	80.000
1152 x 870@75Hz	MAC21	75.06	68.68	100.00
1920 x 1080@60Hz	1920 x 1080_60	60	67.5	148.5
1920 x 1200@60Hz	1920 x 1200_60 (Reduce Blanking)	59.95	74.038	154
1920 x 1200@120Hz	1920 x 1200_120 (Reduce Blanking)	119.909	152.404	317.00
1920 x 1080(VESA)	1920 x 1080_60 (for Auditorium model)	59.963	67.158	173
1920 x 1080@120Hz	1920 x 1080_120	120.000	135.000	297
2560 x 1600	2560 x 1600_60 (Reduce Blanking) For 4K2K model	59.972	98.713	268.5
3840 x 2160	3840 x 2160_30 (Reduce Blanking) For 4K2K model	29.97	65.66	257.404

3840 x 2160	3840 x 2160_60 (Reduce Blanking) For 4K2K model (only via HDMI 2.0 port)	59.94	133.187	522.092
3840 x 2160	3840 x 2160_30 For 4K2K model	30	67.5	297
3840 x 2160	3840 x 2160_60 For 4K2K model (only via HDMI 2.0 port)	60	135	594



The timings showing above may not be supported due to EDID file and VGA graphic card limitations. It is possible that some timings cannot be chosen.

• Video timings

Timing	Resolution	Vertical Frequency (Hz)	Horizontal Frequency (kHz)	Pixel Frequency (MHz)
480i	720 (1440) x 480	59.94	15.73	27
480p	720 x 480	59.94	31.47	27
576i	720 (1440) x 576	50	15.63	27
576p	720 x 576	50	31.25	27
720/50p	1280 x 720	50	37.5	74.25
720/60p	1280 x 720	60	45.00	74.25
1080/24P	1920 x 1080	24	27	74.25
1080/25P	1920 x 1080	25	28.13	74.25
1080/30P	1920 x 1080	30	33.75	74.25
1080/50i	1920 x 1080	50	28.13	74.25
1080/60i	1920 x 1080	60	33.75	74.25
1080/50P	1920 x 1080	50	56.25	148.5
1080/60P	1920 x 1080	60	67.5	148.5
2160/24P	3840 x 2160	24	54	297
2160/25P	3840 x 2160	25	56.25	297
2160/30P	3840 x 2160	30	67.5	297
2160/50P	3840 x 2160 (only via HDMI 2.0 port)	50	112.5	594
2160/60P	3840 x 2160 (only via HDMI 2.0 port)	60	135	594

Supported timing for HDBaseT input

- Video timings

Cable type	Cable Range	HDMI format support	
CAT 5E/CAT 6A	100m	640x480p/60Hz 4:3	24bit 30bit 36 bit
		720x480p/60Hz 4:3	24bit 30bit 36 bit
		720x480p/60Hz 16:9	24bit 30bit 36 bit
		1280x720p/60Hz 16:9	24bit 30bit 36 bit
		1920x1080i/60Hz 16:9	24bit 30bit 36 bit
		1440x480i/60Hz 4:3	24bit 30bit 36 bit
		1920x1080p/60Hz 16:9	24bit 30bit 36 bit
		720x576p/50Hz 4:3	24bit 30bit 36 bit
		1280x720p/50Hz 16:9	24bit 30bit 36 bit
		1920x1080i/50Hz 16:9	24bit 30bit 36 bit
		1440x576i/50Hz 4:3	24bit 30bit 36 bit
		1920x1080p/50Hz 16:9	24bit 30bit 36 bit
CAT 5E	50m	3840x2160p 30Hz	24bit
CAT 5E	50m	3840x2160p 60Hz YCbCr 4:2:0	24bit
CAT 5E	70m	3840x2160p 30Hz	24bit
CAT 6A	100m	3840x2160p 30Hz	24bit

RS232 command

RS232 pin assignment

No.	Serial
1	NC
2	RX
3	TX
4	NC
5	GND

No.	Serial
6	NC
7	RTSZ
8	CTS2
9	NC

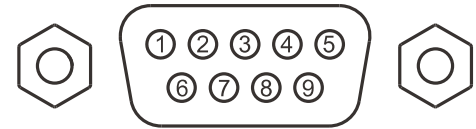

Function	Type	Operation	ASCII
Power	Write	Power On	<CR>*pow=on#<CR>
	Write	Power off	<CR>*pow=off#<CR>
	Read	Power Status	<CR>*pow=?#<CR>
Source Selection	Write	COMPUTER/YPbPr	<CR>*sour=RGB#<CR>
	Write	HDMI	<CR>*sour=hdmi#<CR>
	Write	HDMI 2	<CR>*sour=hdmi2#<CR>
	Write	HDbaseT	<CR>*sour=hdbaset#<CR>
	Read	Current source	<CR>*sour=?#<CR>
	Write	Presentation	<CR>*appmod=preset#<CR>
	Write	sRGB	<CR>*appmod=srgb#<CR>
	Write	Bright	<CR>*appmod=bright#<CR>
	Write	Cinema	<CR>*appmod=cine#<CR>
	Write	DICOM	<CR>*appmod=dicom#<CR>
	Write	User1	<CR>*appmod=user1#<CR>
	Write	User2	<CR>*appmod=user2#<CR>
	Write	ISF Day	<CR>*appmod=isfday#<CR>
	Write	ISF Night	<CR>*appmod=isfnight#<CR>
Read	Picture Mode	<CR>*appmod=?#<CR>	
Picture Setting	Write	Contrast +	<CR>*con=+#<CR>
	Write	Contrast -	<CR>*con=-#<CR>
	Read	Contrast value	<CR>*con=?#<CR>
	Write	Brightness +	<CR>*bri=+#<CR>
	Write	Brightness -	<CR>*bri=-#<CR>
	Read	Brightness value	<CR>*bri=?#<CR>
	Write	Color +	<CR>*color=+#<CR>
	Write	Color -	<CR>*color=-#<CR>
	Read	Color value	<CR>*color=?#<CR>
	Write	Sharpness +	<CR>*sharp=+#<CR>
	Write	Sharpness -	<CR>*sharp=-#<CR>
	Read	Sharpness value	<CR>*sharp=?#<CR>
	Write	Color Temperature-Warm	<CR>*ct=warm#<CR>
	Write	Color Temperature-Normal	<CR>*ct=normal#<CR>
	Write	Color Temperature-Cool	<CR>*ct=cool#<CR>
	Write	Color Temperature-lamp native	<CR>*ct=ative#<CR>
	Read	Color Temperature Status	<CR>*ct=?#<CR>
	Write	Aspect 4:3	<CR>*asp=4:3#<CR>
	Write	Aspect 16:9	<CR>*asp=16:9#<CR>
	Write	Aspect 2.35:1	<CR>*asp=2.35#<CR>
	Write	Aspect Auto	<CR>*asp=AUTO#<CR>
Read	Aspect Status	<CR>*asp=?#<CR>	
Write	Auto	<CR>*auto#<CR>	

Function	Type	Operation	ASCII
Operation Settings	Write	Projector Position-Front Table	<CR>*pp=FT#<CR>
	Write	Projector Position-Rear Table	<CR>*pp=RE#<CR>
	Write	Projector Position-Rear Ceiling	<CR>*pp=RC#<CR>
	Write	Projector Position-Front Ceiling	<CR>*pp=FC#<CR>
	Write	Quick auto search	<CR>*QAS=on#<CR>
	Write	Quick auto search	<CR>*QAS=off#<CR>
	Read	Quick auto search status	<CR>*QAS=?#<CR>
	Read	Projector Position Status	<CR>*pp=?#<CR>
	Write	Direct Power On-on	<CR>*directpower=on#<CR>
	Write	Direct Power On-off	<CR>*directpower=off#<CR>
	Read	Direct Power On-Status	<CR>*directpower=?#<CR>
	Write	Standby Settings-Network on	<CR>*standbynet=on#<CR>
	Write	Standby Settings-Network off	<CR>*standbynet=off#<CR>
	Read	Standby Settings-Network Status	<CR>*standbynet=?#<CR>
Lamp Control	Read	Lamp Hour	<CR>*ltim=?#<CR>
	Write	Normal mode	<CR>*lampm=lnor#<CR>
	Write	Eco mode	<CR>*lampm=eco#<CR>
	Write	Dimming mode	<CR>*lampm=dimming#<CR>
	Write	Custom mode	<CR>*lampm=custom#<CR>
	Write	Light level for custom mode	<CR>*lampcustom=value#<CR>
	Read	Light level status for custom mode	<CR>*lampcustom=?#<CR>
	Read	Lamp Mode Status	<CR>*lampm=?#<CR>
Miscellaneous	Read	Model Name	<CR>*modelname=?#<CR>
	Write	Blank On	<CR>*blank=on#<CR>
	Write	Blank Off	<CR>*blank=off#<CR>
	Read	Blank Status	<CR>*blank=?#<CR>
	Write	Menu On	<CR>*menu=on#<CR>
	Write	Menu Off	<CR>*menu=off#<CR>
	Write	Up	<CR>*up#<CR>
	Write	Down	<CR>*down#<CR>
	Write	Right	<CR>*right#<CR>
	Write	Left	<CR>*left#<CR>
	Write	Enter	<CR>*enter#<CR>
	Write	AMX Device Discovery-on	<CR>*amxdd=on#<CR>
	Write	AMX Device Discovery-off	<CR>*amxdd=off#<CR>
	Read	AMX Device Discovery Status	<CR>*amxdd=?#<CR>
	Read	Mac Address	<CR>*macaddr=?#<CR>
	Write	High Altitude mode on	<CR>*Highaltitude=on#<CR>
	Write	High Altitude mode off	<CR>*Highaltitude=off#<CR>
Read	High Altitude mode status	<CR>*Highaltitude=?#<CR>	